


# Dell EMC DD and PowerProtect Hardware

## Features and Specifications

7.0-7.1

## Notes, cautions, and warnings

 **NOTE:** A NOTE indicates important information that helps you make better use of your product.

 **CAUTION:** A CAUTION indicates either potential damage to hardware or loss of data and tells you how to avoid the problem.

 **WARNING:** A WARNING indicates a potential for property damage, personal injury, or death.

# Contents

<b>Figures</b> .....	<b>10</b>
<b>Tables</b> .....	<b>15</b>
<b>Chapter 1: Physical and Environmental Requirements</b> .....	<b>21</b>
System operating limits.....	22
Environmental recovery.....	22
Air quality requirements.....	22
Shipping and storage requirements.....	22
Shock and Vibration.....	23
<b>Chapter 2: DD3300</b> .....	<b>24</b>
DD3300 system features.....	25
DD3300 system specifications.....	25
DD3300 storage capacity.....	27
Front panel.....	27
Left control panel.....	28
Right control panel.....	30
Front disks.....	31
Service tag.....	31
Rear panel.....	32
Product serial number tag (PSNT).....	34
Rear SSD.....	34
NIC indicators.....	35
Power supply indicators.....	35
<b>Chapter 3: DD4200</b> .....	<b>37</b>
DD4200 system features.....	38
DD4200 system specifications.....	38
DD4200 storage capacity.....	40
Front Panel.....	41
Power supply units.....	41
AC power extender module.....	41
Cooling Fans.....	42
Solid-state drives.....	42
Front LED Indicators.....	42
Back Panel.....	45
I/O module LEDs.....	45
Management module and interfaces.....	45
I/O modules and slot assignments.....	47
Slot addition rules.....	47
Internal system components.....	49
DIMM modules.....	49
DD4200 and ES30 shelf guidelines.....	49
Types of cabinets and power connections.....	50

Cabling shelves.....	60
ES30 and DD4200 cabling.....	61
DD4200 and DS60 shelf guidelines.....	66
Single phase power connections for 40U-P (current racks).....	67
3-phase power connections for 40U-P (current racks).....	68
DS60 and DD4200 cabling.....	72
<b>Chapter 4: DD4500.....</b>	<b>76</b>
DD4500 system features.....	77
DD4500 system specifications.....	77
DD4500 storage capacity.....	79
Front Panel.....	80
Power supply units.....	80
AC power extender module.....	80
Cooling Fans.....	81
Solid-state drives.....	81
Front LED Indicators.....	81
Back Panel.....	84
I/O module LEDs.....	84
Management module and interfaces.....	84
I/O modules and slot assignments.....	86
Slot addition rules.....	86
Internal system components.....	88
DIMM modules.....	88
DD4500 and ES30 shelf guidelines.....	88
Single phase power connections for 40U-P (current racks).....	89
Cabling shelves.....	90
ES30 and DD4500 cabling.....	91
DD4500 and DS60 shelf guidelines.....	96
Single phase power connections for 40U-P (current racks).....	97
3-phase power connections for 40U-P (current racks).....	98
DS60 and DD4500 cabling.....	102
<b>Chapter 5: DD6300.....</b>	<b>109</b>
DD6300 system features.....	109
DD6300 system specifications.....	110
DD6300 storage capacity.....	110
DD6300 front panel.....	111
Front LED indicators.....	111
Back panel.....	113
DD6300 rear SSDs.....	113
Rear LED indicators.....	113
I/O modules.....	116
I/O module population rules.....	117
Internal system components.....	119
DIMMs overview.....	119
DD6300 and ES30 shelf guidelines.....	120
Types of cabinets and power connections.....	120
Cabling shelves.....	120

DD6300, DD6800, and DD9300 shelf configurations.....	121
DD6300 and DS60 shelf guidelines.....	121
shelf configurations.....	122
<b>Chapter 6: DD6800.....</b>	<b>124</b>
DD6800 system features.....	124
DD6800 system specifications.....	125
DD6800 storage capacity.....	125
DD6800 front panel.....	126
Front LED indicators.....	126
Back panel.....	128
Rear LED indicators.....	128
I/O modules.....	130
I/O module population rules.....	131
Internal system components.....	133
DIMMs overview.....	133
DD6800 and ES30 shelf guidelines.....	134
Types of cabinets and power connections.....	135
Cabling shelves.....	135
DD6300, DD6800, and DD9300 shelf configurations.....	135
DD6800 and DS60 shelf guidelines.....	136
shelf configurations.....	137
<b>Chapter 7: DD6900.....</b>	<b>138</b>
DD6900 system features.....	138
DD6900 system specifications.....	139
DD6900 storage capacity and configurations.....	140
DD6900 front panel.....	141
Front LEDs.....	141
DD6900 SSD usage and configurations.....	143
Rear panel.....	144
Rear LEDs.....	145
PCIe HBAs.....	146
Slot assignment.....	146
I/O population rules.....	147
DD6900 DIMM configurations.....	147
DD6900, DD9400, and DD9900 storage shelves configurations and capacities.....	148
<b>Chapter 8: DD7200.....</b>	<b>150</b>
DD7200 system features.....	151
DD7200 system specifications.....	152
DD7200 storage capacity.....	153
Front Panel.....	154
Power supply units.....	154
AC power extender module.....	154
Cooling Fans.....	155
Solid-state drives.....	155
Front LED Indicators.....	155
Back Panel.....	158

I/O module LEDs.....	158
Management module and interfaces.....	158
I/O modules and slot assignments.....	160
Slot addition rules.....	160
Internal system components.....	162
DIMM modules.....	162
DD7200 and ES30 shelf guidelines.....	162
Single phase power connections for 40U-P (current racks).....	163
Cabling shelves.....	164
ES30 and DD7200 cabling.....	165
DD7200 and DS60 shelf guidelines.....	171
Single phase power connections for 40U-P (current racks).....	171
3-phase power connections for 40U-P (current racks).....	172
DS60 and DD7200 cabling.....	176
<b>Chapter 9: DD9300.....</b>	<b>183</b>
system features.....	183
system specifications.....	184
DD9300 storage capacity.....	184
DD9300 front panel.....	185
Front LED indicators.....	185
Back panel.....	187
Rear LED indicators.....	187
I/O modules.....	189
I/O module population rules.....	190
Internal system components.....	192
DIMMs overview.....	192
DD9300 and ES30 shelf guidelines.....	193
Types of cabinets and power connections.....	194
Cabling shelves.....	194
DD6300, DD6800, and DD9300 shelf configurations.....	194
DD9300 and DS60 shelf guidelines.....	195
3-phase power connections for 40U-P (current racks).....	196
shelf configurations.....	196
<b>Chapter 10: DD9400.....</b>	<b>198</b>
DD9400 system features.....	198
DD9400 system specifications.....	199
DD9400 storage capacity and configurations.....	200
DD9400 front panel.....	201
Front LEDs.....	202
DD9400 SSD usage and configurations.....	203
Rear panel.....	204
Rear LEDs.....	205
PCIe HBAs.....	206
Slot assignment.....	206
I/O population rules.....	207
DD9400 DIMM configurations.....	207
DD6900, DD9400, and DD9900 storage shelves configurations and capacities.....	208

<b>Chapter 11: DD9500</b> .....	<b>210</b>
System features.....	211
System specifications.....	212
DD9500 storage capacity.....	213
Front panel.....	214
Front LED indicators.....	214
Solid-state drives.....	217
Rear panel.....	218
Power supply units.....	218
Management module.....	219
Rear LED indicators.....	220
Available I/O modules.....	221
Ethernet I/O module options.....	222
Fibre Channel I/O modules.....	222
SAS I/O modules.....	222
I/O module slot assignments.....	222
Slot addition rules.....	223
Internal System Components.....	224
DIMM modules.....	226
Cooling fans.....	226
DD9500 and ES30 shelf guidelines.....	226
Types of cabinets and power connections.....	227
Cabling shelves.....	228
DD9500 and cabling.....	228
DD9500 and DS60 shelf guidelines.....	229
3-phase power connections for 40U-P (current racks).....	229
DD9500 and DD9800 cabling.....	229
 <b>Chapter 12: DD9800</b> .....	 <b>231</b>
DD9800 system features.....	232
DD9800 system specifications.....	233
DD9800 storage capacity.....	234
DD9800 front panel.....	235
Front LED indicators.....	235
Solid-state drives.....	238
Rear panel.....	239
Power supply units.....	239
Management module.....	240
Rear LED indicators.....	241
Available I/O modules.....	242
Ethernet I/O module options.....	243
Fibre Channel I/O modules.....	243
SAS I/O modules.....	243
I/O module slot assignments.....	243
Slot addition rules.....	244
Internal system components.....	245
DIMM modules.....	247
Cooling fans.....	247

DD9800 and ES30 shelf guidelines.....	247
Types of cabinets and power connections.....	248
Cabling shelves.....	248
DD9500 and cabling.....	249
DD9800 and DS60 shelf guidelines.....	250
3-phase power connections for 40U-P (current racks).....	250
DD9500 and DD9800 cabling.....	250
<b>Chapter 13: DD9900.....</b>	<b>252</b>
DD9900 system features.....	252
DD9900 system specifications.....	253
DD9900 storage capacity and configurations.....	254
DD9900 front panel.....	255
Front LEDs.....	255
DD9900 SSD usage and configurations.....	257
DD9900 rear panel.....	258
Rear LEDs.....	259
PCIe HBAs.....	260
Slot assignment.....	260
I/O population rules.....	260
DD9900 DIMM configurations.....	261
DD6900, DD9400, and DD9900 storage shelves configurations and capacities.....	262
<b>Chapter 14: DS60.....</b>	<b>264</b>
DS60 overview.....	264
DS60 site requirements.....	264
DS60 hardware specifications.....	265
DS60 front panel .....	266
Back panel.....	266
Disk enclosure interior .....	267
Expansion shelf cables.....	270
Ports.....	271
<b>Chapter 15: ES30.....</b>	<b>272</b>
ES30 overview.....	272
Site requirements.....	272
ES30 hardware specifications.....	273
Front panel.....	273
Back panel.....	275
Ports.....	276
<b>Chapter 16: ES40.....</b>	<b>277</b>
ES40 overview.....	277
Dimensions and weights.....	277
Power requirements.....	277
DAE-to-DAE copper cabling.....	279
Product service tag.....	279
<b>Chapter 17: FS15.....</b>	<b>280</b>



Overview of FS15 SSD drives.....	280
Site requirements.....	280
FS15 hardware specifications.....	281
FS15 front panel.....	281
Back panel.....	283
Status LEDs.....	284
<b>Chapter 18: FS25.....</b>	<b>286</b>
Overview of FS25 SSD drives.....	286
Dimensions and weight.....	286
Power requirements.....	286
DAE-to-DAE copper cabling.....	288
Product service tag.....	288
<b>Index.....</b>	<b>289</b>

# Figures

1	Front panel.....	28
2	Left control panel.....	29
3	Right control panel.....	30
4	Disk LEDs.....	31
5	Service tag.....	32
6	Rear panel.....	32
7	2 x 10 GbE module.....	33
8	4 x 16 Gbps FC module.....	33
9	PSNT location.....	34
10	Disk LEDs.....	34
11	NIC LEDs.....	35
12	Power supply LED.....	36
13	Front panel components.....	41
14	System LEDs.....	42
15	System LED legend label.....	43
16	Power supply LEDs.....	43
17	Fan and SSD LEDs.....	44
18	Features on rear of chassis.....	45
19	Interfaces on the management module.....	46
20	Top view of SP module with SP cover removed.....	49
21	Single phase power connections for the 40U-P expansion rack.....	51
22	Single phase power connections for the DD4200, DD4500, and DD7200.....	52
23	Single phase power connections for the Expansion Rack.....	53
24	Single phase power connections for the DD4200, DD4500, and DD7200.....	54
25	Single phase power connections for the Expansion Rack.....	55
26	Single phase power connections for the DD4200, DD4500, and DD7200.....	56
27	Recommended 3-phase delta power connections for the Expansion Rack.....	57
28	Recommended 3-phase delta power connections for DD4200, DD4500, and DD7200.....	58
29	Recommended 3-phase wye power connections for the Expansion Rack.....	59
30	3-phase wye power connections for DD4200, DD4500, and DD7200.....	60
31	Recommended DD4200 cabling.....	63
32	Recommended cabling for DD4200 integrated with Avamar.....	64
33	Recommended cabling for DD4200 system with extended retention software or DD Cloud Tier.....	65
34	Recommended cabling for DD4200 with extended retention and integrated with Avamar.....	66
35	Single phase power connections for DD4200, DD4500, and DD7200 systems.....	68
36	3-phase delta power connections for DS60 expansion shelves (full-racked).....	69
37	3-phase delta power connections for DD4200, DD4500, and DD7200 systems.....	70
38	3-phase wye power connections for DS60 expansion shelves (full-racked).....	71
39	3-phase wye power connections for DD4200, DD4500, and DD7200 systems.....	72
40	Recommended cabling for DD4200 (3TB drives).....	74

41	Recommended cabling for DD4200 (3TB drives) with Extended Retention Software.....	75
42	Front panel components.....	80
43	System LEDs.....	81
44	System LED legend label.....	82
45	Power supply LEDs.....	82
46	Fan and SSD LEDs.....	83
47	Features on rear of chassis.....	84
48	Interfaces on the management module.....	85
49	Top view of SP module with SP cover removed.....	88
50	Single phase power connections for DD4200, DD4500, and DD7200 systems.....	90
51	Recommended DD4500 cabling.....	93
52	Recommended cabling for DD4500 integrated with Avamar.....	94
53	Recommended cabling for DD4500 with extended retention software or DD Cloud Tier.....	95
54	Recommended cabling for DD4500 with extended retention and integrated with Avamar.....	96
55	Single phase power connections for DD4200, DD4500, and DD7200 systems.....	98
56	3-phase delta power connections for DS60 expansion shelves (full-racked).....	99
57	3-phase delta power connections for DD4200, DD4500, and DD7200 systems.....	100
58	3-phase wye power connections for DS60 expansion shelves (full-racked).....	101
59	3-phase wye power connections for DD4200, DD4500, and DD7200 systems.....	102
60	Recommended cabling for DD4500 (3TB drives).....	104
61	Recommended cabling for DD4500 (3TB drives) with Extended Retention software.....	105
62	Recommended cabling for DD4500 with DD Cloud Tier.....	106
63	Recommended cabling for DD4500 (4TB drives).....	107
64	Recommended cabling for DD4500 (4TB drives) with Extended Retention software.....	108
65	Front LED indicators.....	112
66	Rear LED indicators.....	113
67	I/O module Power/Service LED location.....	115
68	Onboard network port LEDs.....	116
69	I/O module slot numbering.....	116
70	CPU and memory locations.....	119
71	Front LED indicators.....	126
72	Rear LED indicators.....	128
73	I/O module Power/Service LED location.....	129
74	Onboard network port LEDs.....	130
75	I/O module slot numbering.....	130
76	CPU and memory locations.....	133
77	System dimensions.....	139
78	DD6900 front panel.....	141
79	Front left control panel status LEDs.....	141
80	Front right control panel power button LEDs.....	142
81	Drive LEDs.....	143
82	DD6900 SSD slot assignment.....	144
83	System rear panel.....	144

84	Onboard ID and iDRAC LEDs.....	145
85	Slot numbering.....	147
86	Front panel components.....	154
87	System LEDs.....	155
88	System LED legend label.....	156
89	Power supply LEDs.....	156
90	Fan and SSD LEDs.....	157
91	Features on rear of chassis.....	158
92	Interfaces on the management module.....	159
93	Top view of SP module with SP cover removed.....	162
94	Single phase power connections for DD4200, DD4500, and DD7200 systems.....	164
95	Recommended DD7200 cabling.....	167
96	Recommended cabling for DD7200 integrated with Avamar.....	168
97	Recommended cabling for DD7200 with extended retention software or DD Cloud Tier.....	169
98	Recommended cabling for DD7200 with extended retention and integrated with Avamar.....	170
99	Single phase power connections for DD4200, DD4500, and DD7200 systems.....	172
100	3-phase delta power connections for DS60 expansion shelves (full-racked).....	173
101	3-phase delta power connections for DD4200, DD4500, and DD7200 systems.....	174
102	3-phase wye power connections for DS60 expansion shelves (full-racked).....	175
103	3-phase wye power connections for DD4200, DD4500, and DD7200 systems.....	176
104	Recommended cabling for DD7200 (3TB drives).....	178
105	Recommended cabling for DD7200 (4TB drives).....	179
106	Recommended cabling for DD7200 (3TB drives) with Extended Retention software.....	180
107	Recommended cabling for DD7200 with DD Cloud Tier.....	181
108	Recommended cabling for DD7200 (4TB drives) with Extended Retention software.....	182
109	Front LED indicators.....	186
110	Rear LED indicators.....	187
111	I/O module Power/Service LED location.....	188
112	Onboard network port LEDs.....	189
113	I/O module slot numbering.....	189
114	CPU and memory locations.....	192
115	System dimensions.....	199
116	DD9400 front panel.....	201
117	Front left control panel status LEDs.....	202
118	Front right control panel power button LEDs.....	202
119	Drive LEDs.....	203
120	DD9400 SSD slot assignment.....	204
121	System rear panel.....	204
122	Onboard ID and iDRAC LEDs.....	205
123	Slot numbering.....	207
124	Front panel components.....	214
125	Service LEDs.....	215
126	Power button.....	216

127	Front LEDs.....	216
128	SSD drives.....	217
129	Features on rear of chassis.....	218
130	Serial number tag location.....	218
131	Four power supplies.....	219
132	Management module.....	219
133	1000BaseT Ethernet ports.....	220
134	Rear LEDs.....	220
135	Power supply LEDs.....	220
136	Location of NVRAM and I/O modules.....	222
137	SP module.....	225
138	Releasing a memory riser.....	225
139	Open fan tray.....	226
140	Front panel components.....	235
141	Service LEDs.....	236
142	Power button.....	237
143	Front LEDs.....	237
144	SSD drives.....	238
145	Features on rear of chassis.....	239
146	Serial number tag location.....	239
147	Four power supplies.....	240
148	Management module.....	240
149	1000BaseT Ethernet ports.....	241
150	Rear LEDs.....	241
151	Power supply LEDs.....	241
152	Location of NVRAM and I/O modules.....	243
153	SP module.....	246
154	Releasing a memory riser.....	246
155	Open fan tray.....	247
156	System dimensions.....	253
157	DD9900 front panel.....	255
158	Front left control panel status LEDs.....	255
159	Front right control panel power button LEDs.....	256
160	Drive LEDs.....	257
161	DD9900 rear panel.....	258
162	Onboard ID and iDRAC LEDs.....	259
163	Slot numbering.....	261
164	DS60 front panel.....	266
165	DS60 back panel.....	266
166	Fans and disk drives inside the disk enclosure.....	267
167	Drives as packs.....	269
168	HD-mini-SAS connector.....	270
169	ES30 front panel (bezel removed).....	274

170	Front panel LEDs.....	274
171	Back panel: Power modules and controllers.....	275
172	Power Supply A LEDs.....	276
173	FS15 front panel (bezel removed).....	282
174	Front panel LEDs.....	282
175	Back panel: Power modules and controllers.....	283
176	Power Supply A LEDs.....	284
177	Rear panel overview.....	285

1	Shipping and storage requirements.....	22
2	DD3300 system features.....	25
3	DD3300 system specifications.....	25
4	System operating environment.....	25
5	DD3300 storage capacity.....	27
6	Front disk slot numbers.....	28
7	Rear disk slot numbers.....	33
8	Network daughter card port identifiers.....	33
9	Optional 10 GbE module port identifiers.....	33
10	Optional 16 Gbps FC module port identifiers.....	34
11	NIC LED states.....	35
12	DD4200 system features.....	38
13	DD4200 system specifications.....	38
14	System operating environment.....	39
15	DD4200 storage capacity.....	40
16	LED status indicators.....	44
17	DD4200 slot assignments.....	47
18	DD4200 and ES30 shelf configuration.....	50
19	Minimum and maximum configurations.....	61
20	DD4200 cabling information.....	61
21	DD4200 and DS60 shelf configuration.....	67
22	Minimum and maximum configurations.....	73
23	DD4500 system features.....	77
24	DD4500 system specifications.....	77
25	System operating environment.....	78
26	DD4500 storage capacity.....	79
27	LED status indicators.....	83
28	DD4500 slot assignments.....	86
29	DD4500 and ES30 shelf configuration.....	89
30	Minimum and maximum configurations.....	91
31	DD4500 cabling information.....	91
32	DD4200 and DS60 shelf configuration.....	97
33	Minimum and maximum configurations.....	103
34	DD6300 system features.....	109
35	DD6300 system specifications.....	110
36	System operating environment.....	110
37	DD6300 storage capacity.....	110
38	DD6300 AIO capacity.....	111
39	DD6300 AIO configuration.....	111
40	DD6300 AIO expanded configuration.....	111

41	Front LEDs.....	112
42	DD6300 rear SSDs.....	113
43	I/O LEDs.....	115
44	Onboard network port LEDs.....	116
45	DD6300 I/O slot module mapping.....	117
46	I/O module slot population rules.....	117
47	DD6300 memory DIMM configuration.....	119
48	Memory locations - CPU 0.....	119
49	Memory locations - CPU 1.....	119
50	DD6300 and ES30 shelf configuration.....	120
51	Minimum and maximum configurations.....	121
52	DD6300 and DS60 shelf configuration.....	122
53	Minimum configurations.....	122
54	DD6800 system features.....	124
55	DD6800 system specifications.....	125
56	System operating environment.....	125
57	DD6800 storage capacity.....	125
58	DD6800 DLH SSD requirements.....	126
59	DD6800 DLH configuration drive layout.....	126
60	DD6800 DLH expanded configuration drive layout.....	126
61	Front LEDs.....	127
62	I/O LEDs.....	129
63	Onboard network port LEDs.....	130
64	I/O module slot mapping.....	131
65	I/O module slot population rules.....	131
66	memory DIMM configuration.....	133
67	Memory locations - CPU 0.....	133
68	Memory locations - CPU 1.....	133
69	DD6800 and ES30 shelf configuration.....	134
70	Minimum and maximum configurations.....	135
71	DD6800 and DS60 shelf configuration.....	136
72	Minimum configurations.....	137
73	DD6900 system features.....	138
74	DD6900 system specifications.....	139
75	System operating environment.....	139
76	DD6900 storage capacity and configurations.....	140
77	HA configuration requirements.....	140
78	Front panel features.....	141
79	Front LEDs.....	141
80	System health and system ID indicator codes.....	142
81	Right control panel features.....	142
82	iDRAC Direct LED indicator codes.....	143
83	DD6900 SSD configurations.....	144



84	SSD boot drives.....	144
85	PSU FRU LEDs.....	146
86	DD6900 slot assignments.....	146
87	Memory configurations.....	148
88	DD6900 DIMM configuration CPU 1.....	148
89	DD6900 DIMM configuration CPU 2.....	148
90	Shelves shipped from factory, in rack.....	148
91	Shelves shipped from factory, boxed.....	148
92	Additional shelves supported.....	148
93	Shelf usable capacities.....	149
94	Supported shelf count per chain.....	149
95	DD7200 system features.....	151
96	DD7200 system specifications.....	152
97	System operating environment.....	152
98	DD7200 storage capacity.....	153
99	LED status indicators.....	157
100	DD7200 slot assignments.....	160
101	DD7200 and ES30 shelf configuration.....	163
102	Minimum and maximum configurations.....	165
103	DD7200 cabling information.....	165
104	DD7200 and DS60 shelf configuration.....	171
105	Minimum and maximum configurations.....	177
106	system features.....	183
107	system specifications.....	184
108	System operating environment.....	184
109	DD9300 storage capacity.....	184
110	DD9300 DLH SSD requirements.....	185
111	DD9300 DLH configuration drive layout.....	185
112	DD9300 DLH expanded configuration drive layout.....	185
113	Front LEDs.....	186
114	I/O LEDs.....	188
115	Onboard network port LEDs.....	189
116	I/O module slot mapping.....	190
117	I/O module slot population rules.....	190
118	memory DIMM configuration.....	192
119	Memory locations - CPU 0.....	192
120	Memory locations - CPU 1.....	192
121	DD9300 and ES30 shelf configuration.....	193
122	Minimum and maximum configurations.....	194
123	DD9300 and DS60 shelf configuration.....	195
124	Minimum configurations.....	196
125	DD9400 system features.....	198
126	DD9400 system specifications.....	199

127	System operating environment.....	200
128	DD9400 storage capacity and configurations.....	200
129	HA configuration requirements.....	200
130	Front panel features.....	201
131	Front LEDs.....	201
132	System health and system ID indicator codes.....	202
133	Right control panel features.....	203
134	iDRAC Direct LED indicator codes.....	203
135	DD9400 SSD configurations.....	204
136	SSD boot drives.....	204
137	PSU FRU LEDs.....	206
138	DD9400 slot assignments.....	206
139	Memory configurations.....	208
140	DD9400 base DIMM configuration CPU 1.....	208
141	DD9400 base DIMM configuration CPU 2.....	208
142	Shelves shipped from factory, in rack.....	208
143	Shelves shipped from factory, boxed.....	208
144	Additional shelves supported.....	209
145	Shelf usable capacities.....	209
146	Supported shelf count per chain.....	209
147	DD9500 system features.....	211
148	DD9500/DD9800 system specifications.....	212
149	DD9500 storage capacity.....	213
150	DD9500 with ES30 SAS shelves.....	213
151	DD9500 with DS60 shelves.....	213
152	Front panel LED status indicators.....	217
153	Rear LED status indicators.....	221
154	Physical to logical port mapping example.....	222
155	DD9500 I/O module slot assignments.....	223
156	I/O module slot population rules.....	224
157	DD9500 memory configurations.....	226
158	DD9500 and ES30 shelf configuration.....	227
159	Minimum and maximum configurations.....	228
160	DD9500 and DS60 shelf configuration.....	229
161	Minimum and maximum configurations.....	230
162	DD9800 system features.....	232
163	DD9800 system specifications.....	233
164	DD9800 storage capacity.....	234
165	DD9800 with ES30 SAS shelves.....	234
166	DD9800 with DS60 shelves.....	234
167	Front panel LED status indicators.....	238
168	Rear LED status indicators.....	242
169	Physical to logical port mapping example.....	243

170	DD9800 I/O module slot assignments.....	244
171	I/O module slot population rules.....	245
172	DD9800 memory configurations.....	247
173	DD9800 and ES30 shelf configuration.....	248
174	Minimum and maximum configurations.....	249
175	DD9800 and DS60 shelf configuration.....	250
176	Minimum and maximum configurations.....	251
177	DD9900 system features.....	252
178	DD9900 system specifications.....	253
179	System operating environment.....	254
180	DD9900 storage capacity and configurations.....	254
181	HA configuration requirements.....	254
182	Front panel features.....	255
183	Front LEDs.....	255
184	System health and system ID indicator codes.....	256
185	Right control panel features.....	256
186	iDRAC Direct LED indicator codes.....	257
187	DD9900 SSD configurations.....	258
188	SSD boot drives.....	258
189	PSU FRU LEDs.....	259
190	DD9900 slot assignments.....	260
191	Memory configurations.....	261
192	DD9900 base DIMM configuration CPU 1.....	262
193	DD9900 base DIMM configuration CPU 2.....	262
194	Shelves shipped from factory, in rack.....	262
195	Shelves shipped from factory, boxed.....	262
196	Additional shelves supported.....	262
197	Shelf usable capacities.....	263
198	Supported shelf count per chain.....	263
199	DS60 shelf set support.....	264
200	Site requirements.....	264
201	Hardware specifications.....	265
202	LED status lights.....	266
203	Status lights visible from rear of disk enclosure.....	267
204	LED status lights.....	267
205	Physical drives.....	269
206	HD-mini-SAS to mini-SAS cable part numbers.....	270
207	HD-mini-SAS to ES30 host and ES30 expansion port cable part numbers.....	270
208	ES30 shelves in a set.....	272
209	Site requirements.....	272
210	ES30 hardware specifications.....	273
211	System operating environment.....	273
212	Status lights visible from front of disk enclosure.....	274

213	Status lights visible from rear of disk enclosure.....	276
214	ES40 shelves in a set.....	277
215	Dimensions and weight.....	277
216	AC power specifications.....	278
217	DC power specifications.....	278
218	Number of SSD drives and model compatibility.....	280
219	FS15 site requirements.....	280
220	FS15 hardware specifications.....	281
221	Status lights visible from front of disk enclosure.....	282
222	Status lights visible from rear of disk enclosure.....	284
223	Status LEDs.....	285
224	Number of SSD drives and model compatibility.....	286
225	Dimensions and weight.....	286
226	AC power specifications.....	287
227	DC power specifications.....	287

# Physical and Environmental Requirements

This chapter contains the following topics:

**Topics:**

- [System operating limits](#)
- [Air quality requirements](#)
- [Shipping and storage requirements](#)
- [Shock and Vibration](#)

# System operating limits

The ambient temperature specification is measured at the front bezel inlet. The site must have air conditioning of the correct size and placement to maintain the specified ambient temperature range and offset the heat dissipation listed below.

**NOTE:** For systems mounted in a cabinet, the operating limits listed above must not be exceeded inside the closed cabinet. Equipment mounted directly above or below an enclosure must not restrict the front-to-rear airflow of the storage system. Cabinet doors must not impede the front-to-rear airflow. The cabinet must exhaust air at a rate that is equal to or greater than the sum of the exhaust rates of all the equipment mounted in the cabinet.

## Environmental recovery

If the system exceeds the maximum ambient temperature by approximately 10°C (18°F), the storage processors (SPs) in the processor enclosure begin an orderly shutdown that saves cached data, and then shut themselves down. Link control cards (LCCs) in each DAE power down their disks but remain powered on. If the system detects that the temperature has dropped to an acceptable level, it restores power to the SPs and the LCCs restore power to their disk drives.

## Air quality requirements

The products are designed to be consistent with the requirements of the American Society of Heating, Refrigeration and Air Conditioning Engineers (ASHRAE) Environmental Standard Handbook and the most current revision of Thermal Guidelines for Data Processing Environments, Second Edition, ASHRAE 2009b.

Cabinets are best suited for Class 1 datacom environments, which consist of tightly controlled environmental parameters, including temperature, dew point, relative humidity and air quality. These facilities house mission-critical equipment and are typically fault-tolerant, including the air conditioners.

The data center should maintain a cleanliness level as identified in ISO 14664-1, class 8 for particulate dust and pollution control. The air entering the data center should be filtered with a MERV 11 filter or better. The air within the data center should be continuously filtered with a MERV 8 or better filtration system. In addition, efforts should be maintained to prevent conductive particles, such as zinc whiskers, from entering the facility.

The allowable relative humidity level is 20 to 80% non condensing, however, the recommended operating environment range is 40 to 55%. For data centers with gaseous contamination, such as high sulfur content, lower temperatures and humidity are recommended to minimize the risk of hardware corrosion and degradation. In general, the humidity fluctuations within the data center should be minimized. It is also recommended that the data center be positively pressured and have air curtains on entry ways to prevent outside air contaminants and humidity from entering the facility.

For facilities below 40% relative humidity, it is recommended to use grounding straps when contacting the equipment to avoid the risk of Electrostatic discharge (ESD), which can harm electronic equipment.

As part of an ongoing monitoring process for the corrosiveness of the environment, it is recommended to place copper and silver coupons (per ISA 71.04-1985, Section 6.1 Reactivity), in airstreams representative of those in the data center. The monthly reactivity rate of the coupons should be less than 300 Angstroms. When monitored reactivity rate is exceeded, the coupon should be analyzed for material species and a corrective mitigation process put in place.

Storage time (unpowered) recommendation: do not exceed 6 consecutive months of unpowered storage.

## Shipping and storage requirements

**NOTE:** Systems and components must not experience changes in temperature and humidity that are likely to cause condensation to form on or in that system or component. Do not exceed the shipping and storage temperature gradient of 45°F/hr (25°C/hr).

**Table 1. Shipping and storage requirements**

Requirement	Description
Ambient temperature	-40° F to 149°F (-40°C to 65°C)
Temperature gradient	45°F/hr (25°C/hr)

**Table 1. Shipping and storage requirements (continued)**

<b>Requirement</b>	<b>Description</b>
Relative humidity	10% to 90% noncondensing
Elevation	-50 to 35,000 ft (-16 to 10,600 m)
Storage time (unpowered) Recommendation	Do not exceed 6 consecutive months of unpowered storage.

## Shock and Vibration

Products have been tested to withstand the shock and random vibration levels. The levels apply to all three axes and should be measured with an accelerometer on the equipment enclosures within the cabinet and shall not exceed:

<b>Platform condition</b>	<b>Response measurement level</b>
Non operational shock	10 G's, 7 ms duration
Operational shock	3 G's, 11 ms duration
Non operational random vibration	0.40 Grms, 5–500 Hz, 30 minutes
Operational random vibration	0.21 Grms, 5–500 Hz, 10 minutes

Systems that are mounted on an approved package have completed transportation testing to withstand the following shock and vibrations in the vertical direction only and shall not exceed:

<b>Packaged system condition</b>	<b>Response measurement level</b>
Transportation shock	10 G's, 12ms duration
Transportation random vibration	<ul style="list-style-type: none"> <li>● 1.15 Grms</li> <li>● 1 hour Frequency range 1–200 Hz</li> </ul>

## DD3300

This chapter contains the following topics:

**Topics:**

- [DD3300 system features](#)
- [DD3300 system specifications](#)
- [DD3300 storage capacity](#)
- [Front panel](#)
- [Rear panel](#)



# DD3300 system features

**Table 2. DD3300 system features**

Feature	4 TB configuration	8 TB configuration	16 TB configuration	32 TB configuration
Rack Height	2U, supported in four-post racks only			
Power	1 or 2 hot-swappable power units			
Fans	6 hot swappable fans, installed in two fan assemblies (3 fans per fan assembly)			
Rack mounting	Rack mount kit included with each system. Adjustable between 24 - 36 in. (60.9–76.2 cm).			
Processor	1 x 8-core Intel 4110 series, hyperthreaded			
Voltage	100–240 V~. Frequency: 50 Hz to 60 Hz.			
Internal 3.5" drives (front)	4 x 4 TB HDD	10 x 4 TB HDD	10 x 4 TB HDD	12 x 4 TB HDD
Internal 3.5" drives (middle)	N/A	N/A	N/A	4 x 4 TB HDD
Internal 3.5" drives (rear)	N/A	1 x 480 GB SSD for NVRAM <sup>a</sup>		
NIC	4 x 1 GbE or 4 x 10 GbE (always present) <sup>b</sup> + 2 x 10 GbE (optional)			
FC (DD VTL only)	4 x 16 Gbps (optional)			
Memory	16 GB or 24 GB <sup>c</sup>	48 GB	48 GB or 56 GB <sup>d</sup>	64 GB

- a. The SSD is for use as an NVRAM device, SSD Cache Tier storage only, and Random I/O handling (Instant Access Instant Restore). The maximum supported SSD Cache Tier capacity is one percent of the Active Tier capacity.
- b. Starting with DD OS 6.2, DD3300 systems ship with a 4 x 10 GbE RJ-45 network daughter card.
- c. 24 GB of memory is required to use the FC module for DD VTL.
- d. A 16 TB system will have 56 GB of memory if it was a 4 TB system equipped with the FC module, and was later upgraded to 16 TB.

**NOTE:** DD OS may report less storage and memory than indicated in this table. The unreported resources are used for internal system processes.

# DD3300 system specifications

**Table 3. DD3300 system specifications**

Watts	BTU/hr	Weight	Width	Depth	Height
750	2891	72.91 lb/33.1 kg	17.09 in/43.4 cm	28.17 inches/71.55 cm	3.42 in/8.68 cm

**Table 4. System operating environment**

Operating Temperature	50° to 95° F (10° to 35° C), derate 1.1° C per 1000 feet, above 7500 feet up to 10,000 feet
Operating Humidity	20% to 80%, non-condensing
Non-operating Temperature	-40° to +149° F (-40° to +65° C)

**Table 4. System operating environment (continued)**

Operating Acoustic Noise	Sound power, LWAd: 7.52 bels. Sound pressure, LpAm: 56.4 dB. (Declared noise emission per ISO 9296.)
--------------------------	--

# DD3300 storage capacity

The table lists the capacities of the systems. The system internal indexes and other product components use variable amounts of storage, depending on the type of data and the sizes of files. If you send different datasets to otherwise identical systems, one system may, over time, have room for more or less actual backup data than another.

**Table 5. DD3300 storage capacity**

Configuration	Internal disks - physical <sup>ab</sup>	Internal disks - virtual	Raw storage	Usable storage (local) <sup>c</sup>	Cloud storage	SSD metadata cache storage
4 TB capacity /16 GB memory	4 x 4 TB 7200 RPM NLSAS	<ul style="list-style-type: none"> <li>1 x 4 TB for Active Tier</li> <li>1 x 1 TB for DD Cloud Tier metadata</li> </ul>	16 TB	4 TB	8 TB	N/A
8 TB capacity/48 GB memory	10 x 4 TB 7200 RPM NLSAS	<ul style="list-style-type: none"> <li>4 x 4 TB for Active Tier<sup>d</sup></li> <li>2 x 1 TB for DD Cloud Tier metadata</li> </ul>	40 TB	8 TB	16 TB	160 GB
16 TB capacity/48 GB memory	10 x 4 TB 7200 RPM NLSAS	<ul style="list-style-type: none"> <li>4 x 4 TB for Active Tier</li> <li>2 x 1 TB for DD Cloud Tier metadata</li> </ul>	40 TB	16 TB	32 TB	160 GB
32 TB capacity/64 GB memory	<ul style="list-style-type: none"> <li>12 x 4 TB 7200 RPM NLSAS (front)</li> <li>4 x 4 TB 7200 RPM NLSAS (middle)</li> </ul>	<ul style="list-style-type: none"> <li>8 x 4 TB for Active Tier</li> <li>4 x 1 TB for DD Cloud Tier metadata</li> </ul>	64 TB	32 TB	64 TB	320 GB

- The internal hard drives are configured in a RAID6 configuration. RAID6 provides the system with the ability to withstand the simultaneous failure of two hard drives, or the failure of one hard drive while another hard drive is still rebuilding after a drive replacement operation.
- After replacing a disk, it takes approximately 18 hours to complete the rebuild operation on the new disk, but may take longer depending on the amount of activity on the system.
- The system compensates for the required file system overhead, so the reported usable capacity matches the specified usable capacity.
- For 8 TB configurations, the Active Tier supports a maximum of 2 x 4 TB virtual disks.

## Front panel

The DD3300 front panel consists of two control panels, which contain system LEDs and ports, twelve 3.5" disk drive bays, and the service tag. [Front panel](#) on page 28 shows the locations of the front panel components.



**Figure 1. Front panel**

- 1. Left control panel
- 2. 3.5" disk drive
- 3. Right control panel
- 4. Service tag.

## Disk layout

The following table shows the physical location of each disk slot.

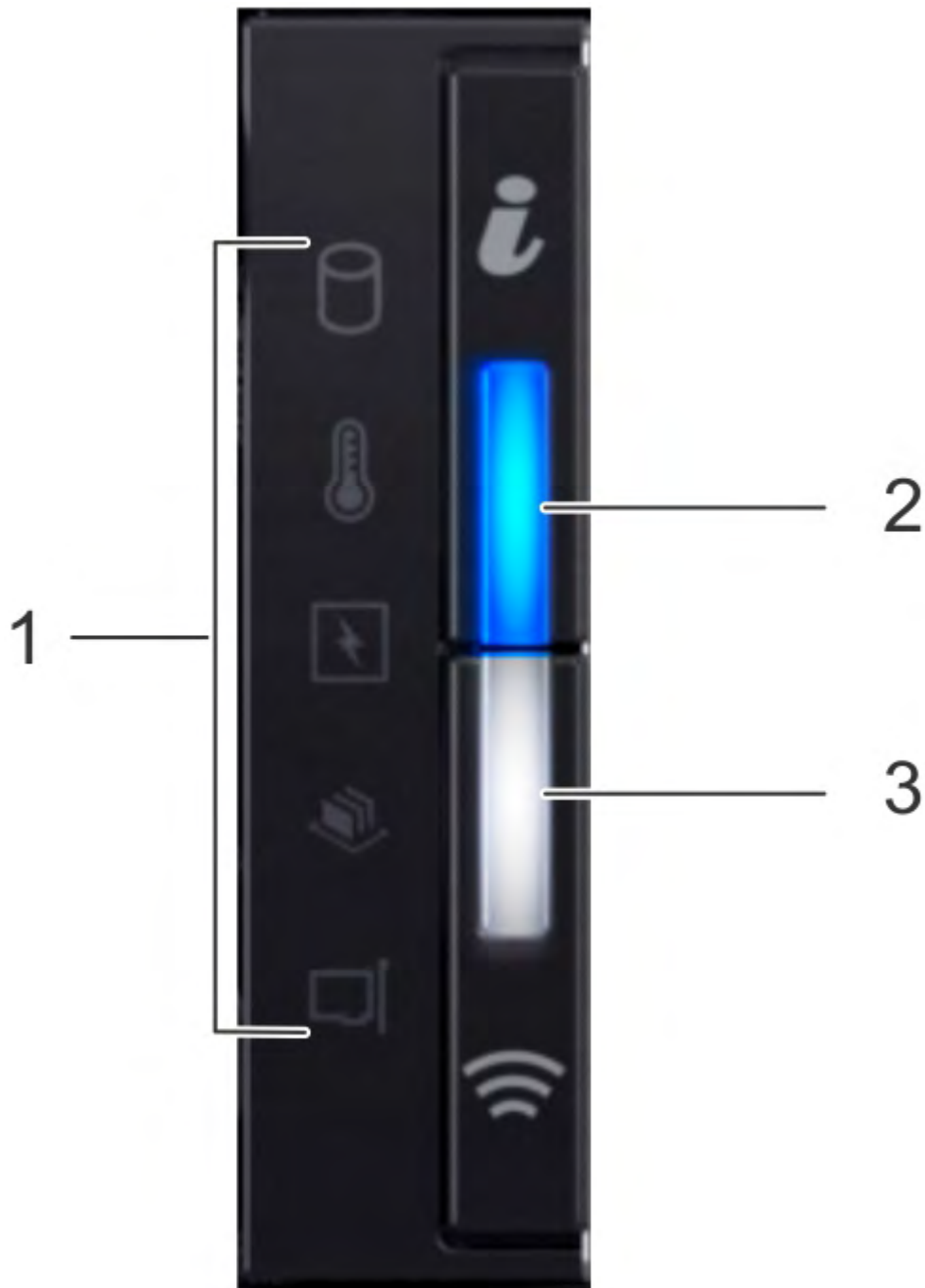
**NOTE:** Although the physical slots are numbered starting from 0, the software identifies the slots starting at 1.

**Table 6. Front disk slot numbers**

Slot 0 (SW slot 1)	Slot 3 (SW slot 4)	Slot 6 (SW slot 7)	Slot 9 (SW slot 10)
Slot 1 (SW slot 2)	Slot 4 (SW slot 5)	Slot 7 (SW slot 8)	Slot 10 (SW slot 11)
Slot 2 (SW slot 3)	Slot 5 (SW slot 6)	Slot 8 (SW slot 9)	Slot 11 (SW slot 12)

## Left control panel

The left control panel contains system status LEDs. [Left control panel](#) on page 29 shows the panel.



**Figure 2. Left control panel**

1. System status LEDs
2. System health and system ID indicator
3. iDRAC Quick Sync 2 wireless indicator (Not supported)

The system status LEDs turn solid amber if the system experiences an error in any of the following categories. Under normal operating conditions, the system status LEDs remain off. From top to bottom, the five system status LEDs are:

- Drive indicator
- Temperature indicator
- Electrical indicator
- Memory indicator
- PCIe indicator

The system health and system ID indicator has the following states:

- Solid blue: Indicator is in system health mode. System is on and healthy.
- Blinking blue: Indicator is in system ID mode.
- **NOTE:** Press the System Health and System ID button to switch the indicator between system health and system ID modes.
- Solid amber: System is in fail-safe mode.
- Blinking amber: System is experiencing a fault.

## Right control panel

The right control panel contains the system power button, and system maintenance ports. [Right control panel](#) on page 30 shows the panel.

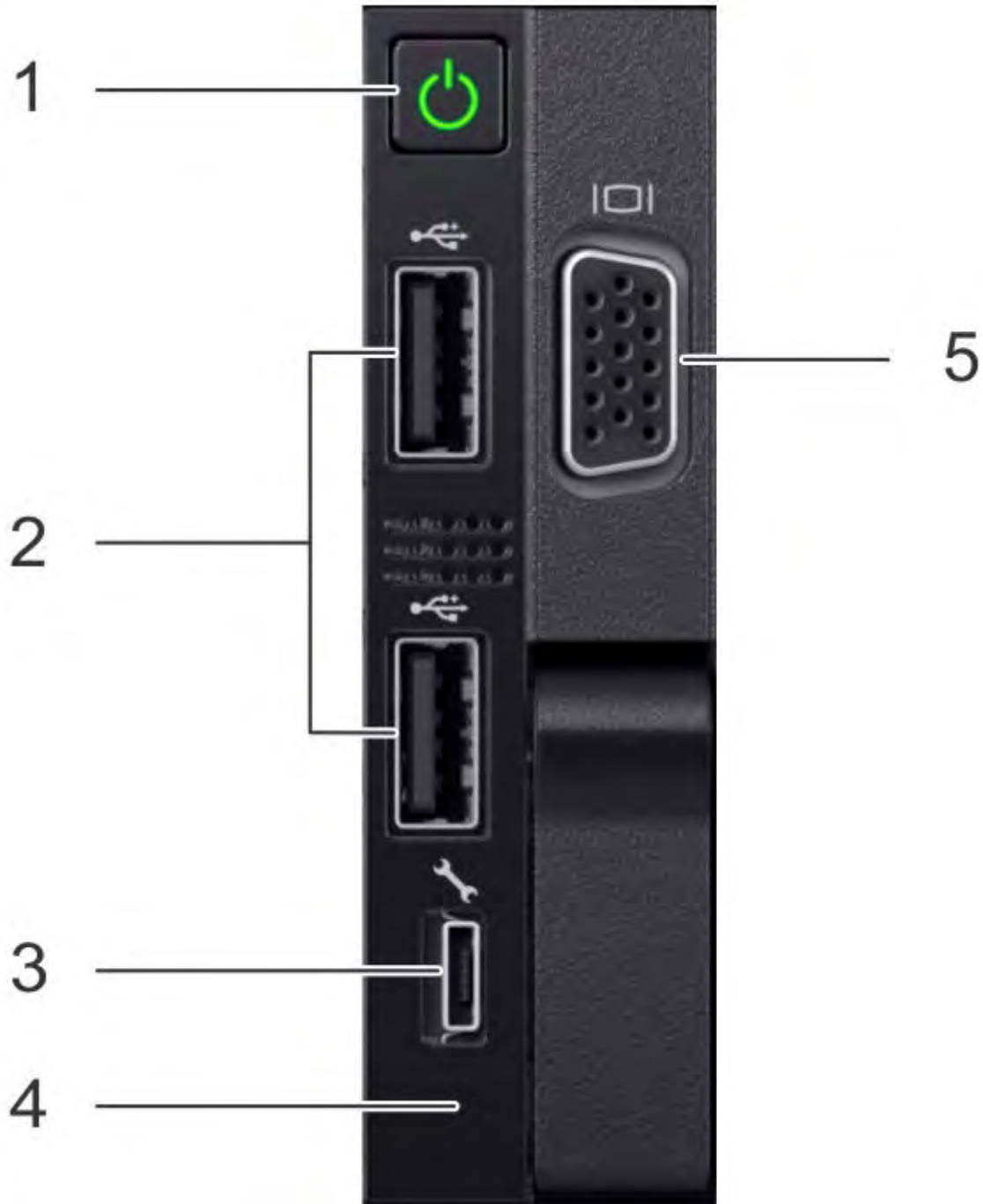
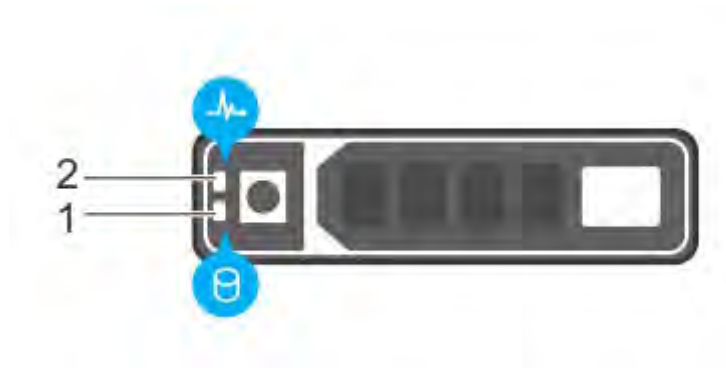


Figure 3. Right control panel

1. Power button
2. Not Supported -- 2 x USB 2.0 ports (Not supported)
3. Not Supported -- iDRAC Direct port (micro USB 2.0)
4. iDRAC Direct LED
5. Not Used -- VGA port

## Front disks

The DD3300 system contains 4, 10, or 12 front-mounted 3.5" HDDs, depending on the capacity configuration. Each HDD has an activity indicator, and a status indicator. [Disk LEDs](#) on page 31 shows the HDD indicators.



**Figure 4. Disk LEDs**

1. HDD activity indicator
2. HDD status indicator

The HDD activity indicator blinks during drive activity.

The HDD status indicator has the following states:

- Flashes green twice per second: Identifying drive or preparing for removal.
- Off: Drive is ready for removal.
- Flashes green, then amber, then turns off: Predicted drive failure.
- Flashes amber four times per second: Drive failed.
- Solid green: Drive online.
- Flashes green slowly: Drive rebuilding.
- Flashes green for three seconds, then amber for three seconds, then turns off: Rebuild stopped.

## Service tag

The DD3300 system service tag is located at the front of the system, in the lower right-hand corner of the chassis. This tag is on all DD3300 systems, and includes the product serial number.

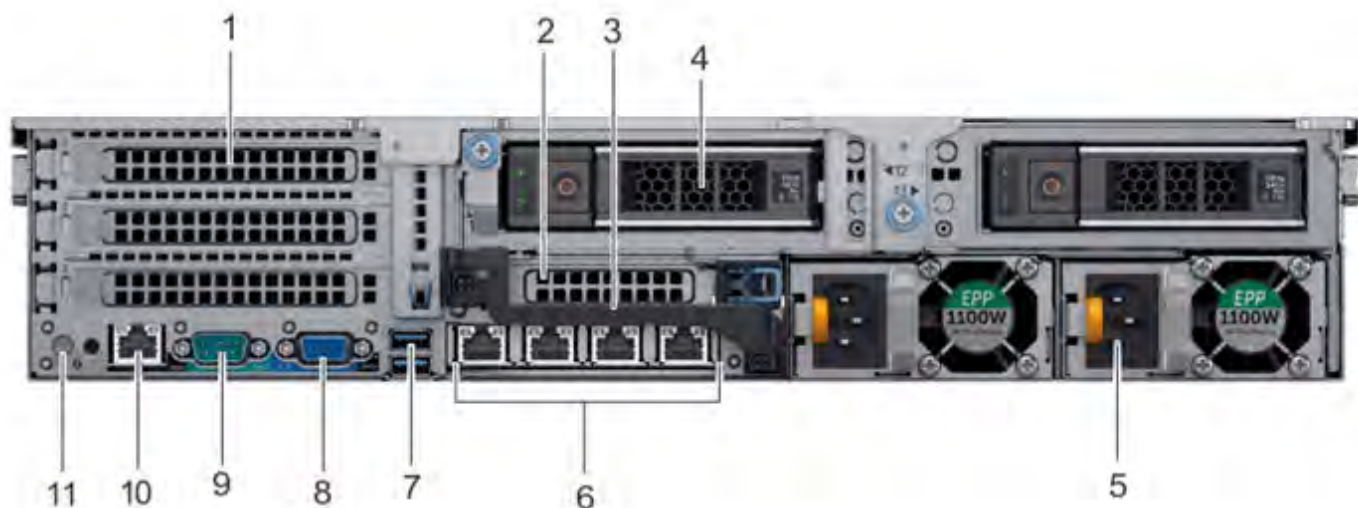


**Figure 5. Service tag**

1. Information tag (top view)
2. Information tag (back view)
3. OpenManage Mobile (OMM) label
4. iDRAC MAC address and secure password label
5. Service tag

## Rear panel

The DD3300 rear panel contains the system serial port, NIC cards, power supplies, and 3.5" drive bays. shows the rear of the system.



**Figure 6. Rear panel**

1. Full height PCIe expansion card slots
  - The top slot is for the optional 2 x 10 GbE NIC
  - The middle slot is for the optional 4 x 16 Gbps FC module
  - The bottom slot is not supported
2. Not Supported -- Half height PCIe expansion card slot
3. Rear handle
4. 3.5" drive bays (used for 1 x 480 GB SSD in the 8 TB, 16 TB, and 32 TB configurations)
5. Power supply units (1 or 2)



- 6. Network daughter card Ethernet ports
- 7. Not Supported -- USB 3.0 ports
- 8. Not Supported -- VGA port
- 9. Serial port
- 10. iDRAC9 dedicated management port
- 11. System identification button

The DD3300 system supports the use of the iDRAC9 dedicated management port to emulate a serial console.

## Disk layout

8 TB, 16 TB, and 32 TB configurations use one rear slot for an SSD. 4 TB configurations do not use an SSD. The following table shows the physical location of the rear SSD slots.

**NOTE:** Although the physical slots are numbered starting from 0, the software identifies the slots starting at 1.

**Table 7. Rear disk slot numbers**

Slot 12 (SW slot 13)	Slot 13 (SW slot 14)
----------------------	----------------------

## Network port layout

The DD3300 network daughter card provides 4 x 1 GbE or 4 x 10 GbE network ports for network connectivity.

**NOTE:** Starting with DD OS 6.2, DD3300 systems ship with a 4 x 10 GbE RJ-45 network daughter card.

The following table lists the layout of the network daughter card ports.

**Table 8. Network daughter card port identifiers**

ethMa	ethMb	ethMc	ethMd
-------	-------	-------	-------

An optional 2 x 10 GbE module is supported on the DD3300 system.



**Figure 7. 2 x 10 GbE module**

The following table lists the layout of the 10 GbE ports.

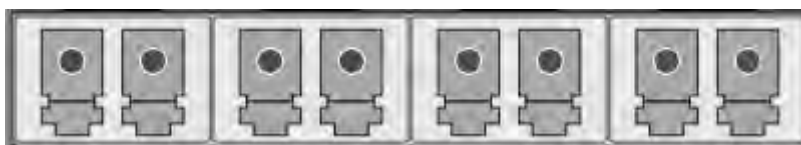
**NOTE:** The 10 GbE module is inserted upside down, therefore the ports are in descending order from left to right.

**Table 9. Optional 10 GbE module port identifiers**

eth1b	eth1a
-------	-------

## FC port layout

An optional 4 x 16 Gbps FC module is supported on the DD3300 system.



**Figure 8. 4 x 16 Gbps FC module**

The following table lists the layout of the FC ports.

**Table 10. Optional 16 Gbps FC module port identifiers**

22d	22c	22b	22a
-----	-----	-----	-----

## Product serial number tag (PSNT)

Some DD3300 systems have a PSNT tag located on the rear of the system, attached to the arm in the center of the chassis. If this tag is not present, the product serial number is always available from the service tag located on the front of the system.

**NOTE:** Service tag on page 31 describes the front-mounted service tag.

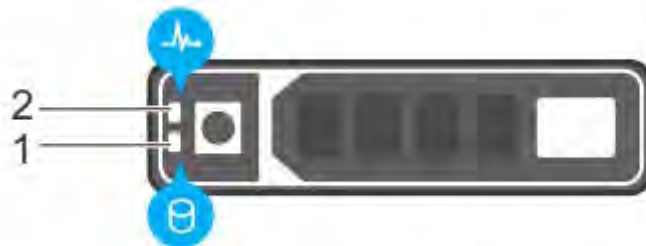


**Figure 9. PSNT location**

If present, the PSNT lists the part number (PN) and serial number (SN) of the system. The PN is 900-555-024. The SN is the 14 digit alphanumeric string that accompanies the part number. This serial number is the default system password for serial console, system manager, and iDRAC access.

## Rear SSD

The DD3300 8 TB, 16 TB, and 32 TB configurations use one rear-mounted 480 GB 2.5" SSD. The SSD has an activity indicator, and a status indicator.



**Figure 10. Disk LEDs**

1. HDD activity indicator
2. HDD status indicator

The HDD activity indicator blinks during drive activity.

The HDD status indicator has the following states:

- Flashes green twice per second: Identifying drive or preparing for removal.
- Off: Drive is ready for removal.
- Flashes green, then amber, then turns off: Predicted drive failure.
- Flashes amber four times per second: Drive failed.
- Solid green: Drive online.

## NIC indicators

All network ports on the DD3300 system have link and activity LED indicators.

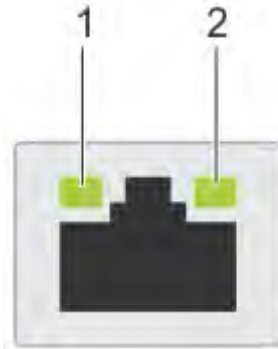


Figure 11. NIC LEDs

1. Link LED indicator
2. Activity LED indicator

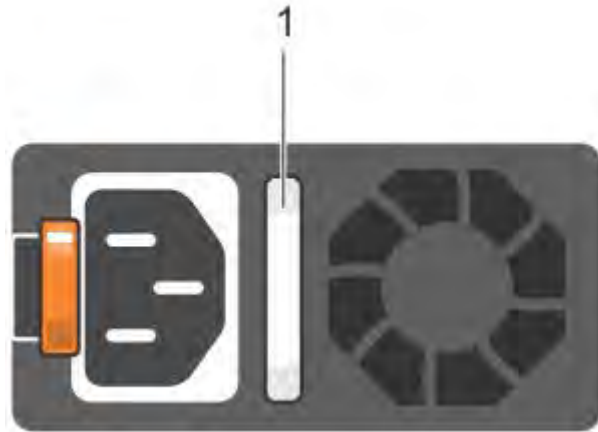
The NIC LEDs have the following states:

Table 11. NIC LED states

Link indicator state	Activity indicator state	Meaning
Green	Blinking green	The NIC is connected to a valid network at its maximum port speed and data is being sent or received.
Amber	Blinking green	The NIC is connected to a valid network at less than its maximum port speed and data is being sent or received.
Green	Off	The NIC is connected to a valid network at its maximum port speed and data is not being sent or received.
Amber	Off	The NIC is connected to a valid network at less than its maximum port speed and data is not being sent or received.
Blinking green	Off	NIC identify is enabled through the NIC configuration utility.

## Power supply indicators

The power supply unit has an illuminated, translucent handle that functions as a status LED.



**Figure 12. Power supply LED**

The indicator has the following states:

- Green: Valid power source is connected, and the PSU is operational.
  - Blinking amber: Indicates a problem with the PSU.
  - Off: Power is not connected.
  - Blinking green: Firmware update is in progress.
- CAUTION: Do not disconnect the power cord or unplug the PSU when updating firmware. If firmware update is interrupted, the PSUs do not function.**
- Blinking green, then off: When hot-plugging a PSU, the PSU handle blinks green five times at a rate of 4 Hz and turns off. This indicates a PSU mismatch with respect to efficiency, feature set, health status, or supported voltage.

# DD4200

This chapter contains the following topics:

**Topics:**

- [DD4200 system features](#)
- [DD4200 system specifications](#)
- [DD4200 storage capacity](#)
- [Front Panel](#)
- [Back Panel](#)
- [I/O modules and slot assignments](#)
- [Internal system components](#)
- [DD4200 and ES30 shelf guidelines](#)
- [DD4200 and DS60 shelf guidelines](#)

## DD4200 system features

The table summarizes the DD4200 system features.

**Table 12. DD4200 system features**

Feature		DD4200 (Base configuration)
Rack height		4U, supported in four-post racks only
Rack mounting		Rack mount kit included with each system. Adjustable between 24 - 36 in. (60.9 - 76.2 cm).
Power		1 +1 redundant, hot-swappable power units
Processor		Two 8-core processors
NVRAM		One 4-GB NVRAM module (and companion BBU) for data integrity during a power outage
Fans		Hot-swappable, redundant, 5
Memory		16 x 8 GB DIMM (128 GB)
Internal drives		SSD drives, 3 x 200 GB (base 10)
I/O module slots		Nine replaceable I/O module (Fibre Channel, Ethernet, and SAS) slots, one BBU, one NVRAM, and one Management module slot. See <a href="#">Management module and interfaces</a> on page 45 and <a href="#">I/O modules and slot assignments</a> on page 47.
Supported capacity	Non-extended retention	8 x 2-TB or 5 x 3-TB shelves adding up to 189 TB of usable external capacity.
	DD Cloud Tier	189 TB of Active Tier capacity, and 378 TB of Cloud Tier capacity. 2x3 TB shelves are required to store DD Cloud Tier metadata.
	DD Extended Retention	24 x 2-TB or 16 x 3-TB shelves adding up to 378 TB of usable external capacity. If lower-capacity 1 TB-drive-based shelves are used, the maximum configuration will also be limited by a maximum shelf count of 32.

## DD4200 system specifications

**Table 13. DD4200 system specifications**

Model	Watts	BTU/hr	Power	Weight	Width	Depth	Height
DD4200	800	2730	800	80 lb / 36.3 kg	17.5 in (44.5 cm)	33 in (84 cm)	7 in (17.8 cm)

**Table 14. System operating environment**

Operating Temperature	50° to 95° F (10° to 35° C), derate 1.1° C per 1000 feet, above 7500 feet up to 10,000 feet
Operating Humidity	20% to 80%, non-condensing
Non-operating Temperature	-40° to +149° F (-40° to +65° C)
Operating Acoustic Noise	Sound power, LWAd: 7.52 bels. Sound pressure, LpAm: 56.4 dB. (Declared noise emission per ISO 9296.)

# DD4200 storage capacity

Data Domain system internal indexes and other product components use variable amounts of storage, depending on the type of data and the sizes of files. If you send different data sets to otherwise identical systems, one system may, over time, have room for more or less actual backup data than another.

**Table 15. DD4200 storage capacity**

System/ Installed Memory	Internal Disks (SATA SSDs)	Data Storage Space	External Storage <sup>3</sup>
DD4200 (2 SAS I/O modules) 128 GB	2.5 in. 3 @ 200 GB No User Data	189 TB	Up to a maximum of 8 x 2-TB or 5 x 3-TB shelves.
DD4200 with DD Cloud Tier <sup>1</sup> (3 SAS I/O modules) 128 GB	2.5 in. 3 @ 200 GB No User Data	<ul style="list-style-type: none"> <li>● 189 TB (Active Tier)</li> <li>● 72 TB (DD Cloud Tier metadata)</li> <li>● 378 TB (DD Cloud Tier)</li> </ul>	Up to a maximum of 8 x 2-TB or 5 x 3-TB shelves. 2x3-TB shelves for DD Cloud Tier metadata.
DD4200 with Extended Retention software <sup>1</sup> (4 SAS I/O modules) 128 GB	2.5 in. 3 @ 200 GB No User Data	378 TB	Up to a maximum of 16 x 2-TB and 10 x 3-TB shelves.

1. Data Domain DD4200 controller with DD Extended Retention software.

2. Data Domain DD4200 controller with DD Cloud Tier.

3. The capacity will differ depending on the size of the external storage shelves used. This data based on ES30 shelves.



# Front Panel

The photo shows the hardware features and interfaces on the front of the system.

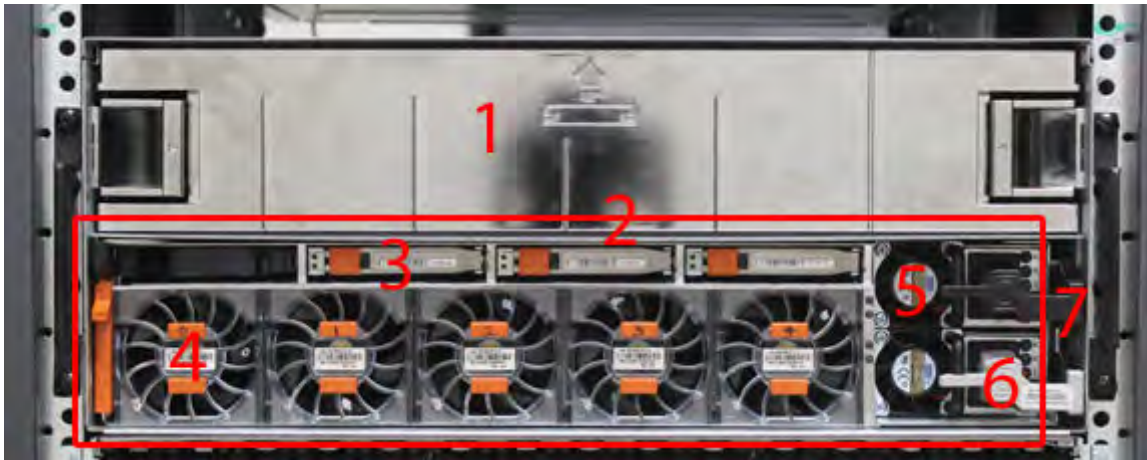


Figure 13. Front panel components

(1)	Filler panel
(2)	The red box indicates the system processor (SP) module
(3)	SSD drive #1
(4)	Fan #0
(5)	Power supply #B
(6)	AC power disconnect plug
(7)	AC power extender module

## Power supply units

A system has two power supply units, numbered A and B from the bottom up. Each power supply has its own integral cooling fan. Each power unit has three LEDs (see [System LED legend label](#) on page 43) that indicates the following states:

- AC LED: Glows green when AC input is good
- DC LED: Glows green when DC output is good
- Symbol “!”: Glows solid or blinking amber for fault or attention

The AC power plugs are located to the right of each power supply. These plugs are pulled to disconnect AC power to each power supply.

## AC power extender module

AC power entry is connected at the rear of the system. The AC power extender module provides power to the two power supplies on the front of the system. AC Power plugs are located in the front. The module is adjacent to the SP module and can be removed and replaced.

## Cooling Fans

A system contains five hot-swappable cooling fans in a 4+1 redundant configuration. The fans provide cooling for the processors, DIMMs, IO modules, and the management module. Each fan has a fault LED which causes the fan housing to glow amber. A system can run with one fan faulted or removed.

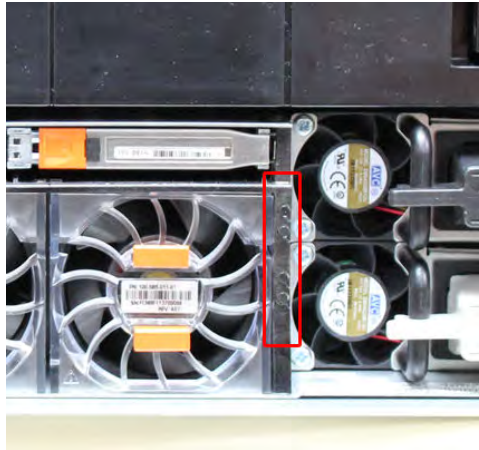
## Solid-state drives

A system contains three hot-swappable 2.5" solid-state drive (SSD) bays that are located in the front and on top of the fan modules. There are four drive bays, with the left-most bay containing a blank. The next drive to the right of the blank is SSD #1, the next is #2, and the right-most bay contains SSD #3. No user backup data is kept on the SSDs.

Each drive has a blue colored power LED and an amber fault LED.

## Front LED Indicators

The photo below indicates the location of the four system LEDs.



**Figure 14. System LEDs**

The next photo shows the location of the system LED legend label. [Power supply LEDs](#) on page 43 shows the power supply LEDs. Other front LEDs are shown in [Fan and SSD LEDs](#) on page 44. LED states are described in [LED status indicators](#) on page 44.

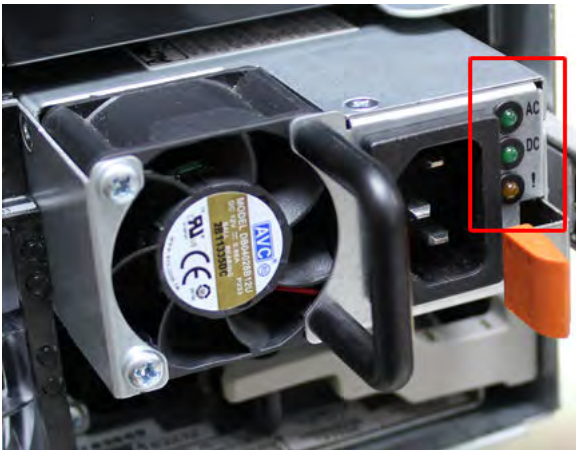


**Figure 15. System LED legend label**

The power supply LEDs include:

- AC LED on top
- DC LED in the middle
- Failure LED on the bottom

**Figure 16. Power supply LEDs**



Each SSD has two LEDs as shown in the following figure. The lower left corner of the housing around each fan acts as an LED, glowing amber when the fan has failed.



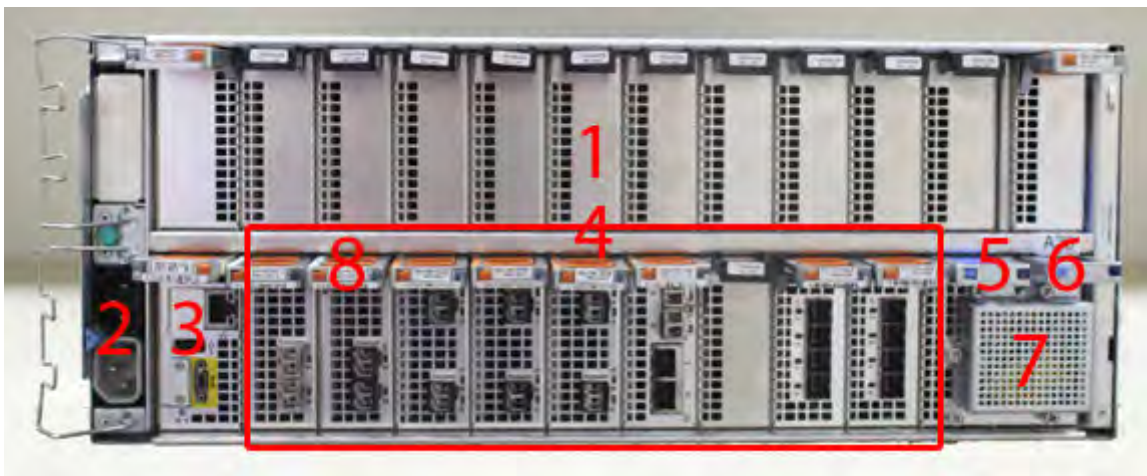
**Figure 17. Fan and SSD LEDs**

**Table 16. LED status indicators**

Part	Description or Location	State
System	Dot within a circle (top LED)	Blue indicates power on and normal operation.
System, SP fault	Exclamation point within a triangle	Dark indicates normal operation. Amber indicates failure.
System, chassis fault	Exclamation point within a triangle with a light below	Dark indicates normal operation. Yellow indicates a fault condition.
System	Marked out hand within a black square (bottom LED)	White warns not to remove the unit.
Power supply	AC LED	Steady green indicates normal AC power.
Power supply	DC LED	Steady green indicates normal DC power.
Power supply	Failure LED	Solid amber indicates a failed power supply.
SSD	Top LED	Solid blue, disk ready, blinks while busy.
SSD	Bottom LED	Dark indicates healthy. Solid amber indicates disk fail.
Fan	Fan housing	The fan housing glows an amber color during fan failure.

## Back Panel

The photo shows the hardware features and interfaces on the back of the system.



**Figure 18. Features on rear of chassis**

1. Upper level contains all blanks
2. AC power extender module
3. Management module (slot Mgmt A)
4. Red box indicating I/O modules (slots 0-8)
5. Battery backup (BBU in slot 9)
6. NVRAM module (slot 10)
7. Cage covering the BBU and NVRAM combination module
8. I/O LED at the end of each I/O module handle
9. Location of serial number label/tag

**NOTE:** For modules containing multiple ports, the bottom port is numbered as zero (0) with numbers increasing going upward.

## I/O module LEDs

Each I/O module ejector handle contains a bi-colored LED. Green indicates normal function, while an amber color indicates a fault condition.

## Management module and interfaces

The management module is on the left-most side when facing the back of the system, in slot Mgmt A. The process to remove and add a management module is the same as the I/O modules, however, the management module can only be accommodated in Mgmt A slot.

The management module contains one external LAN connection for management access to the SP module. One micro DB-9 connector is included to provide the console. A USB port is provided for use during service of the system to allow booting from a USB flash device.



**Figure 19. Interfaces on the management module**

- 1 - Ethernet port
- 2 - USB port
- 3 - Micro serial port



# I/O modules and slot assignments

The table shows the I/O module slot assignments for the systems. See [Features on rear of chassis](#) on page 45 for a view of the slot positions on the back panel and [Top view of SP module with SP cover removed](#) on page 49 for a top view.

**Table 17. DD4200 slot assignments**

Slot Number	DD4200	DD4200 with Extended Retention Software	DD4200 with DD Cloud Tier
MGMT A	Management module	Management module	Management module
0	Fibre Channel (FC), Ethernet or empty	FC, Ethernet or empty	FC, Ethernet or empty
1	FC, Ethernet or empty	FC, Ethernet or empty	FC, Ethernet or empty
2	FC, Ethernet or empty	FC, Ethernet or empty	FC, Ethernet or empty
3	FC, Ethernet or empty	FC, Ethernet or empty	FC, Ethernet or empty
4	Ethernet or empty	Ethernet or empty	Ethernet or empty
5	Ethernet or empty	SAS	Ethernet or empty
6	Empty	SAS	SAS
7	SAS	SAS	SAS
8	SAS	SAS	SAS
9	BBU	BBU	BBU
10	NVRAM	NVRAM	NVRAM

## Slot addition rules

- A maximum of six optional I/O modules (FC plus Ethernet) are allowed in systems without Extended Retention software, and a maximum of five optional I/O modules (FC plus Ethernet) are allowed in systems with Extended Retention software.
- Additional FC modules should be installed in numerically increasing slot numbers immediately to the right of the existing FC modules, or starting in slot 0 if no FC modules were originally installed. A maximum of four FC modules are allowed in a system.
- Additional Ethernet modules should be installed in numerically decreasing slot numbers immediately to the left of the existing Ethernet modules or starting in slot 4 if no Ethernet modules were originally installed. For systems without Extended Retention software, a maximum of six (limited to four of any one type) Ethernet modules can be present. For systems with Extended Retention software, a maximum of five (limited to four of any one type) Ethernet modules can be present.
- All systems include two SAS modules in slots 7 and 8. Systems with Extended Retention software must have two additional SAS modules in slots 5 and 6.
- For systems without Extended Retention software, if adding I/O modules results in the allowed maximum of six I/O modules present, slot 5 is used. Slot 5 is only used for an Ethernet module. Adding FC modules in this specific case require moving an existing Ethernet module to slot 5. Other than this specific case, it is not recommended to move I/O modules between slots.
- Adding Extended Retention software to a system includes adding two SAS modules in slots 5 and 6. If the system originally had the maximum of 6 optional I/O modules, the I/O module in slot 5 must be permanently removed from the system.

## Fibre Channel (FC) I/O Module Option

An FC I/O module is a dual-port Fibre Channel module. The optional virtual tape library (VTL) feature requires at least one FC I/O module. Boost over Fiber Channel is optional and the total FC HBAs cannot exceed more than allowable Fibre Channel cards per controller.

## Ethernet I/O Module Options

The available Ethernet I/O modules are:

- Dual Port 10GBase-SR Optical with LC connectors

- Dual Port 10GBase-CX1 Direct Attach Copper with SPF+ module
- Quad Port 1000Base-T Copper with RJ-45 connectors
- Quad port 2 port 1000Base-T Copper (RJ45) /2 port 1000Base-SR Optical



# Internal system components

The photo shows the system with the system processor (SP) module that is removed from the chassis and the SP cover removed.



Figure 20. Top view of SP module with SP cover removed

- 1 - Front of system
- 2 - Four groups of 4 DIMM cards

## DIMM modules

DD4200 systems contain 16 x 8 GB of memory DIMM.

## DD4200 and ES30 shelf guidelines

The Data Domain system rediscovers newly configured shelves after it restarts. You can power off the system and recable shelves to any other position in a set, or to another set. To take advantage of this flexibility, you need to follow these rules before making any cabling changes:

- Do not exceed the maximum shelf configuration values for your Data Domain system as listed in the following table below.
- Use the Installation and Setup Guide for your Data Domain system to minimize the chance of a cabling mistake.
- A Data Domain system cannot exceed its maximum raw external shelf capacity, regardless of added shelf capacity.
- ES30 SATA shelves must be on their own chain.

### **NOTE:**

- ES30 SAS shelves must be running DD OS 5.4 or later.
- ES30-45 SATA shelves must be running DD OS 5.4 or later.
- DD OS 5.7 and later support 4TB drives.

**Table 18. DD4200 and ES30 shelf configuration**

DD system	Memory required (GB)	SAS cards/port per card	ES30 support (TB)	Max shelves per set	Max number of sets	Max external capacity available (TB) <sup>1</sup>	Max RAW external capacity (TB) <sup>2</sup>
DD4200 <sup>3</sup>	128	2x4	SAS 30, 45; SATA 15, 30, 45 <sup>5</sup>	5 <sup>6</sup>	4	192	256
DD4200 ER <sup>3, 4</sup>	128	4x4	SAS 30, 45; SATA 15, 30, 45 <sup>5</sup>	7	8	384	512
DD4200 w/ DD Cloud Tier	128	3x4	SAS 30, 45; SATA 15, 30, 45 <sup>5</sup>	7	8	192 (max), additional 72 SAS dedicated to DD Cloud Tier	256 (max), additional 90 SAS dedicated to DD Cloud Tier

1. This figure only counts drives that have user data in the shelves.
2. The raw capacity of an ES30 is 125% of the available capacity.
3. The maximum shelf count for any specific drive/shelf size might be less than the product of max shelves x max shelves per set.
4. With Extended Retention software.
5. ES30-45 (SATA) is only supported with DD OS 5.4 or later.
6. 5 shelves maximum with ES30, 4 is the recommended maximum.

## Types of cabinets and power connections

The ES30 chassis is installed in two types of racks: 40U-C (existing racks) and the 40U-P (newer racks). The racks use one phase or 3-phase power connections.

This section describes the different types of racks and the power connections for the ES30 chassis.

### Single phase power connections for 40U-P (current racks)

The following illustrations show single phase power connections for 40U-P racks that are used for several Data Domain systems.

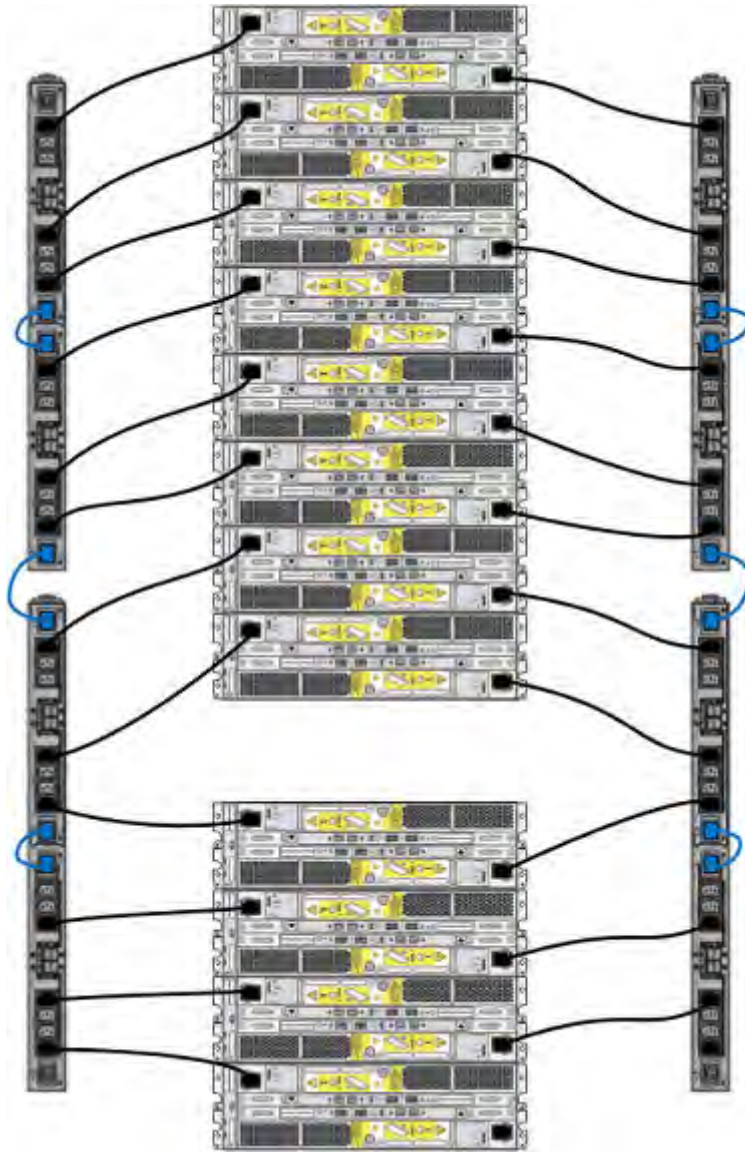
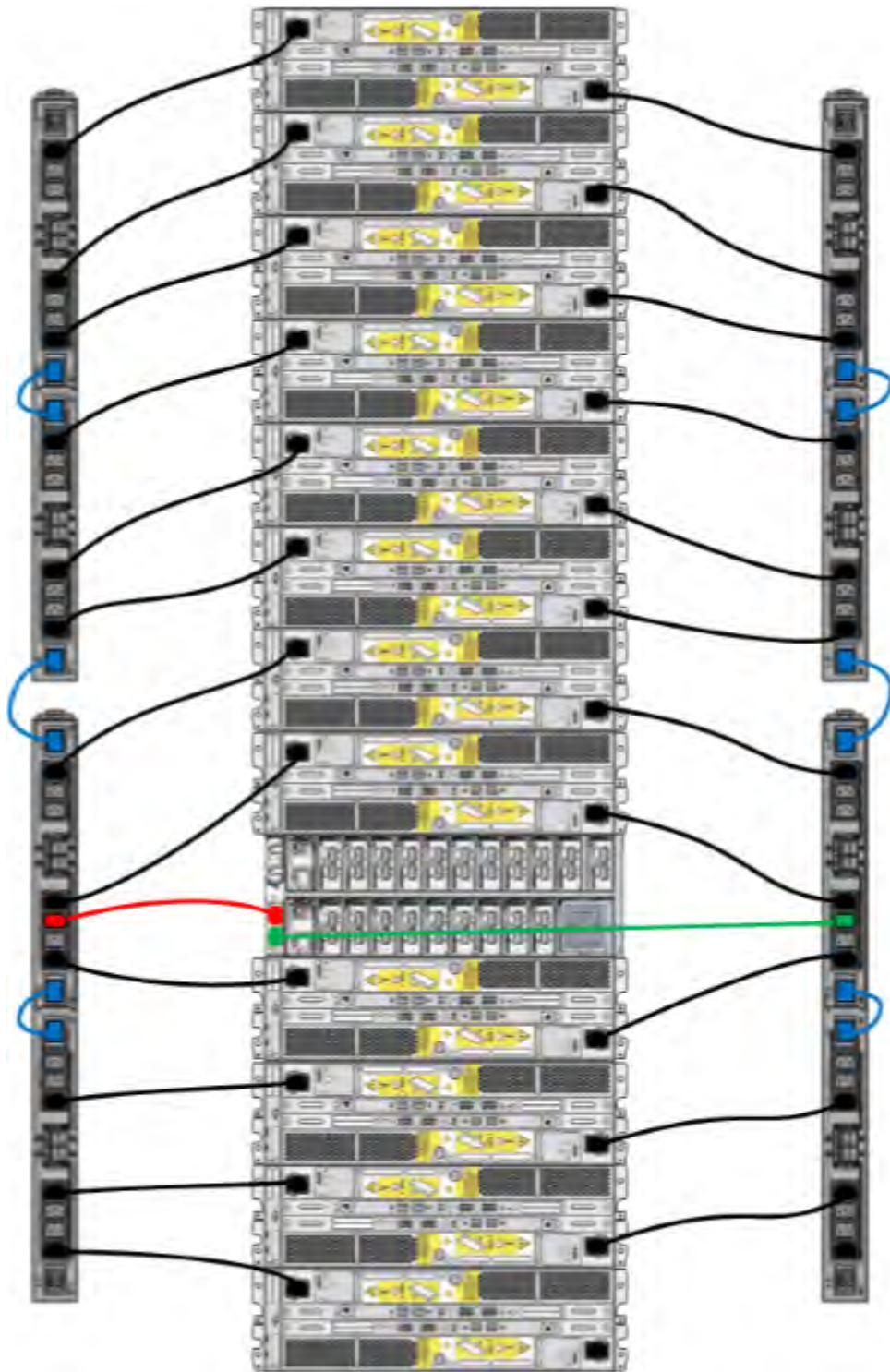


Figure 21. Single phase power connections for the 40U-P expansion rack



**Figure 22. Single phase power connections for the DD4200, DD4500, and DD7200**

### Single phase power connections for 40U-C (older racks)

The following illustrations show single phase power connections for 40U-C racks that are used for several Data Domain systems.

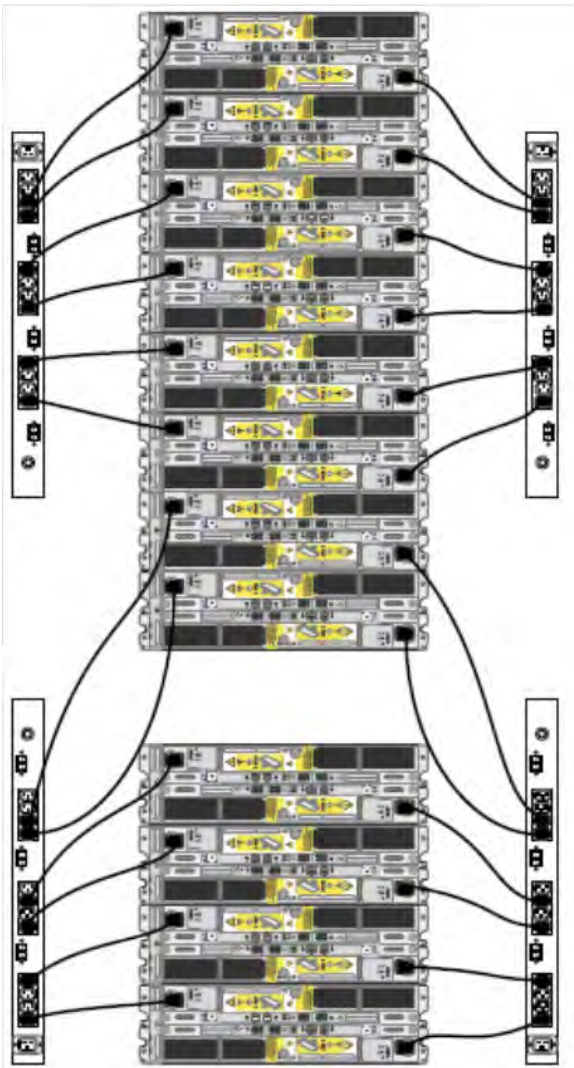


Figure 23. Single phase power connections for the Expansion Rack



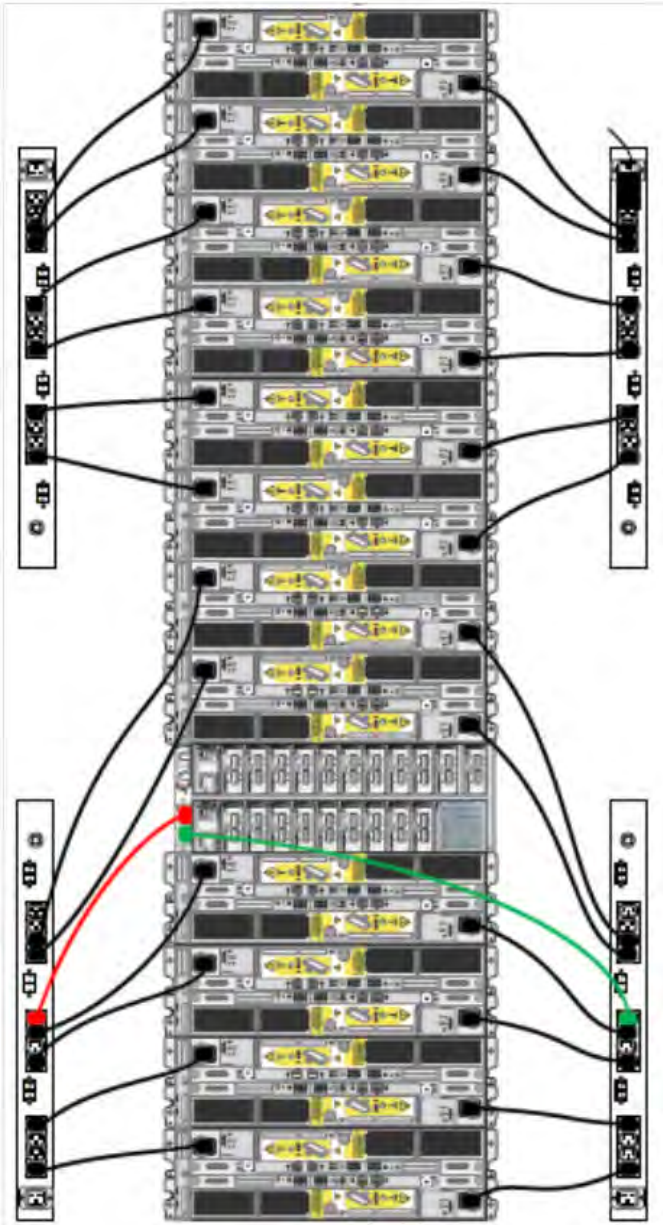


Figure 24. Single phase power connections for the DD4200, DD4500, and DD7200

### 3-Phase power connections for 40U-C (older racks)

The following illustrations show single phase power connections for 40U-C racks that are used for several Data Domain systems.

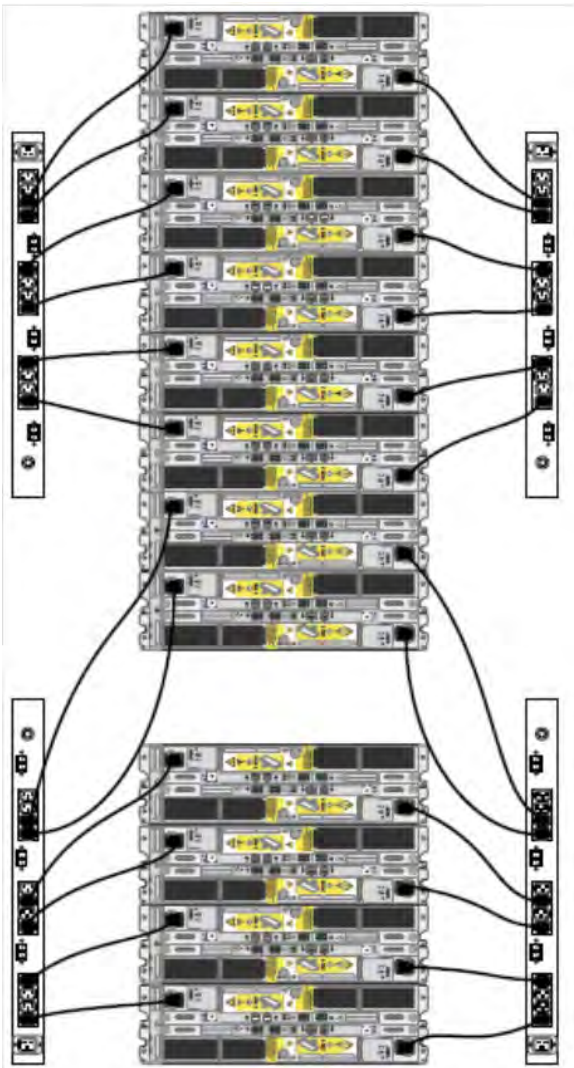


Figure 25. Single phase power connections for the Expansion Rack

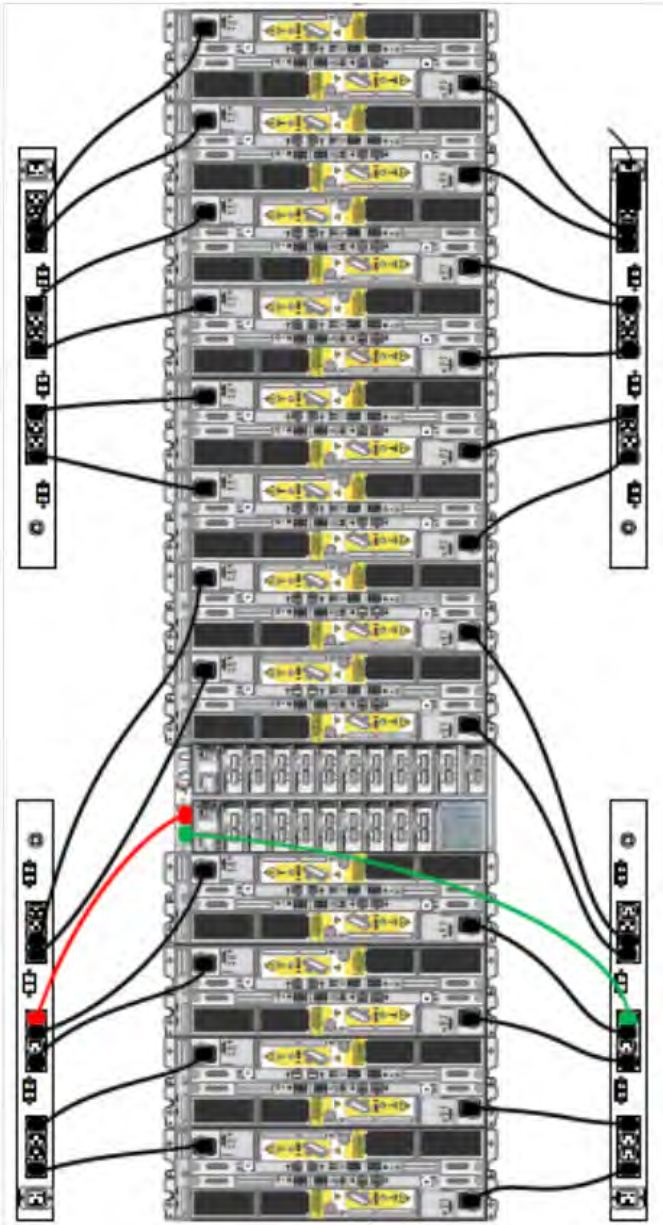


Figure 26. Single phase power connections for the DD4200, DD4500, and DD7200

### 3-Phase power connections for 40U-P (current racks)

Some environments use 3-phase power for 40U-P racks that are used for several Data Domain systems. In those situations, it is desirable to balance the current draw across all three phases. The recommended 3-phase power cabling attempts to do that, but an optimal configuration depends on the specific installation. The following illustrations show recommended 3-phase power connections for several Data Domain systems.

**NOTE:** The next few diagrams show recommended 3-phase delta power connections.



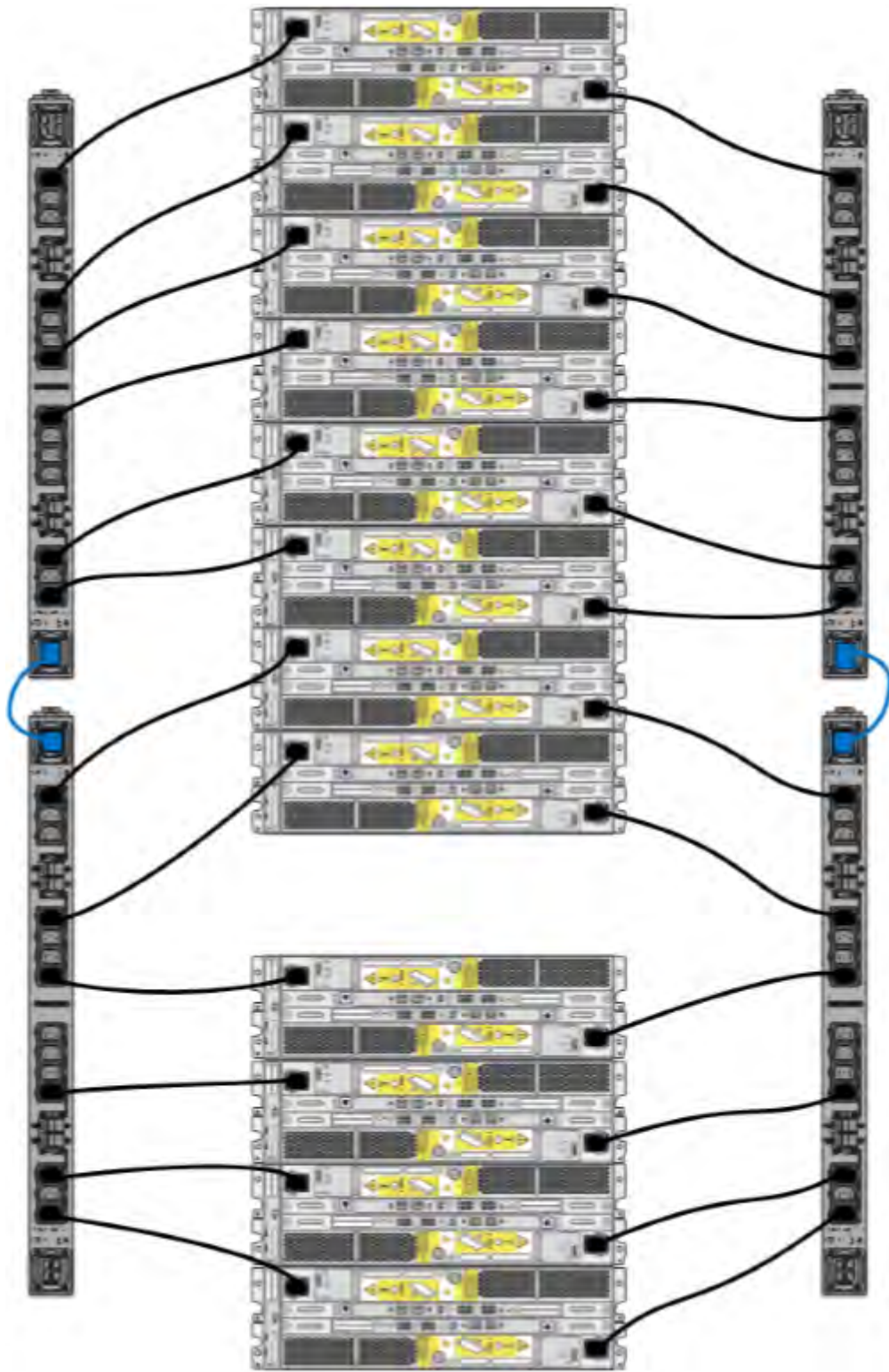


Figure 27. Recommended 3-phase delta power connections for the Expansion Rack

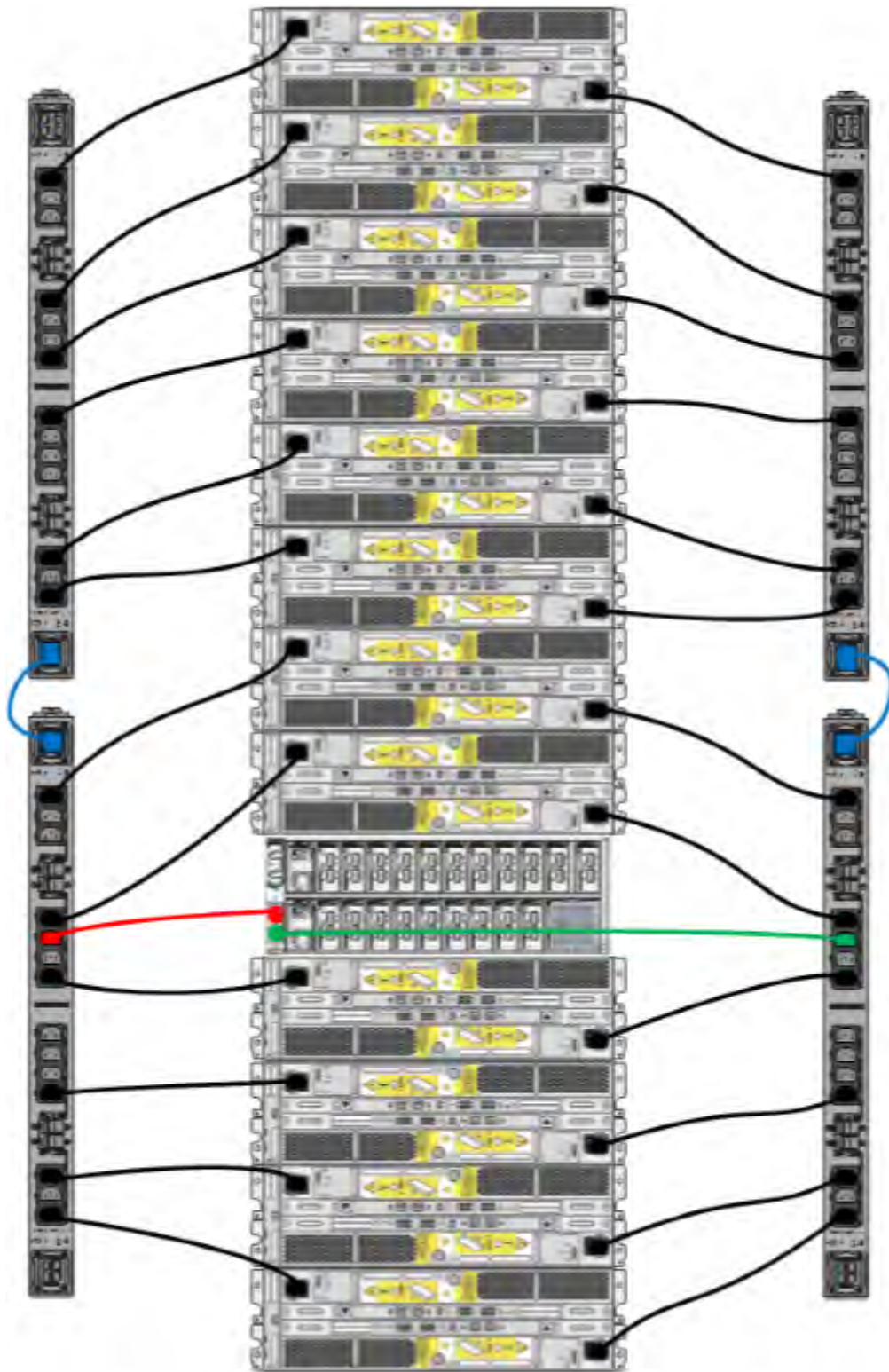


Figure 28. Recommended 3-phase delta power connections for DD4200, DD4500, and DD7200

**NOTE:** The next few diagrams show recommended 3-phase wye power connections.

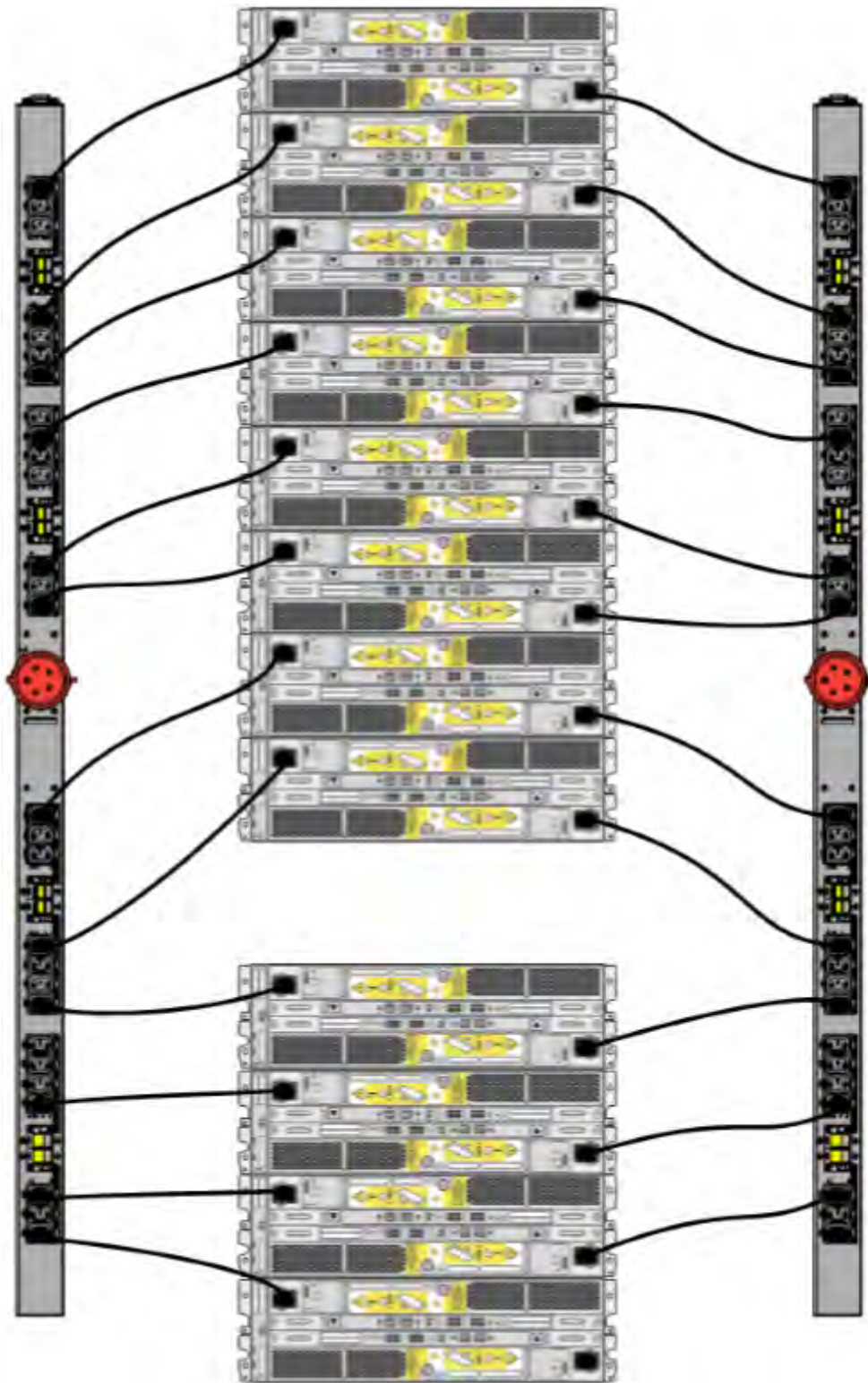


Figure 29. Recommended 3-phase wye power connections for the Expansion Rack



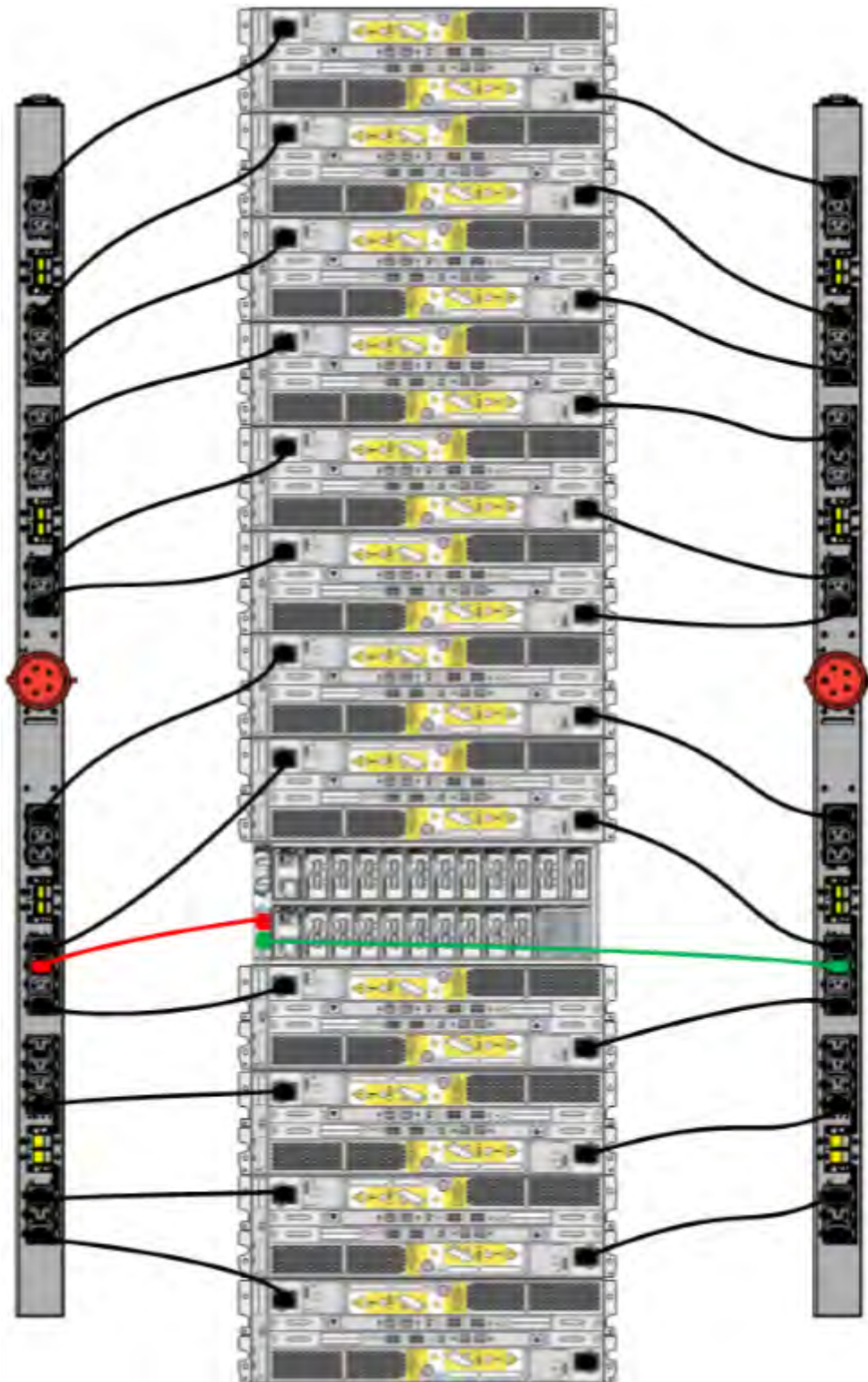


Figure 30. 3-phase wye power connections for DD4200, DD4500, and DD7200

## Cabling shelves

### **i** NOTE:

- Before cabling the shelves, physically install all shelves in the racks. Refer to the rail kit installation instructions included with the ES30 shelf for rack mounting.

- The documentation refers to two SAS HBAs. If only one HBA is allowed in a system, then use another port as defined later for that specific system.
- On an HA system, add cables from the second node to open ports at the end of the sets. The ports on the second node must connect to the same sets as the corresponding ports on the first node.

Ports on the system's SAS HBA cards connect directly to a shelf controller's host port. For redundancy, you need to create dual paths by using a port on one SAS HBA card to connect to one shelf controller in each shelf set, and a port on another SAS HBA card to connect to another shelf controller in the same shelf set. With dual paths, if one SAS HBA card fails, the shelf is still operational. However, in the unlikely event any single shelf becomes completely disconnected from power or SAS cables and becomes disconnected from a previously operational shelf, the file system goes down and the shelf is not operational. This is considered a double failure.

There are two kinds of configurations: one shelf in a set or multiple shelves in a set.

## ES30 and DD4200 cabling

There are a few rules that must be followed when adding a mixture of ES20, ES30 SATA, and ES30 SAS shelves to your system. If a system does not follow ALL of these rules it is not a legitimate configuration.

Prerequisites:

- Follow the minimum and maximum shelf capacity configuration provided in the table.
- You cannot have ES20 and ES30 shelves in the same set.
- You cannot have ES30 SATA and ES30 SAS shelves in the same set.
- You cannot exceed the maximum amount of raw capacity displayed in the product's cabling table.
- The maximum number of shelves displayed in the product's cabling table cannot be exceeded.
- You cannot have more than four ES20s in a single set (maximum preference is three).
- You cannot have more than five ES30s in a single set (maximum preference is four).
- You can have a maximum of seven ES30s for systems with Extended Retention software.
- There are no specific placement or cabling requirements for the metadata shelves for DD Cloud Tier configurations. These shelves can be installed and cabled the same way as standard ES30 shelves.

**NOTE:** An ES20 requires more power than an ES30. Ensure that your rack is configured to handle the power needs.

The tables below show how to configure a mixed system. To use the tables, go to the appropriate system. Then find the number of ES20s that are to be configured in the first column. The next column defines the number of ES20 sets. If there are multiple rows with the same number of ES20s then pick the row with the appropriate number of ES20 SATA shelves. The next column in that row defines the number of sets of ES30 SATA shelves. Finally, there may be entries for the number of desired ES30 SAS shelves and the number of sets to be used.

If the combinations of shelves exceed the supported usable storage, there may not be an entry. The entries are based on the smallest usable storage per shelf type (12TB for ES20, 12 TB for ES30 SATA, and 24TB for ES30 SAS). Always check that the sum of the usable storage of all of the shelves does not exceed the supported usable storage of the configuration.

**Table 19. Minimum and maximum configurations**

System	Minimum appliance shelf count	Maximum appliance shelf count	DD Cloud Tier systems in TB	Extended Retention systems (ER) in TB	Max shelves for ER
4200 (192)	1	16	<ul style="list-style-type: none"> <li>• 189</li> <li>• 90 for metadata</li> </ul>	<ul style="list-style-type: none"> <li>• DD OS 5.4 and earlier: 576</li> <li>• DD OS 5.5 and later: 385</li> </ul>	32

Systems without Extended Retention or DD Cloud Tier all support four chains. The following tables show combinations of ES20 and ES30 shelves. For combinations of any two types of shelves, these tables can be used as a guide.

**Table 20. DD4200 cabling information**

DD4200					
ES20	ES20 chains	ES30 SATA	ES30 SATA chains	ES30 SAS	ES30 SAS chains
13-16	4	0	0	0	0
9-12	3	1-5	1	0	0

**Table 20. DD4200 cabling information (continued)**

DD4200					
9-12	3	0	0	1-3	1
5-8	2	6-10	2	0	0
5-8	2	1-5	1	1-5	1
5-8	2	0	0	5	2
5-8	2	0	0	1-4	1
1-4	1	8-12	3	0	0
1-4	1	6-10	2	1-5	1
1-4	1	1-5	1	1-4	1
1-4	1	1-5	1	5-7	2
1-4	1	0	0	1-4	1
1-4	1	0	0	5-7	2
0	0	13-16	4	0	0
0	0	9-12	3	1-3	1
0	0	5-8	2	1-4	1
0	0	5-8	2	5	2
0	0	1-4	1	1-4	1
0	0	1-4	1	5-7	2
0	0	0	0	1-4	1
0	0	0	0	5-8	2

The following figures show cabling for base systems, systems with the Extended Retention software option, and systems integrated with an Avamar system.

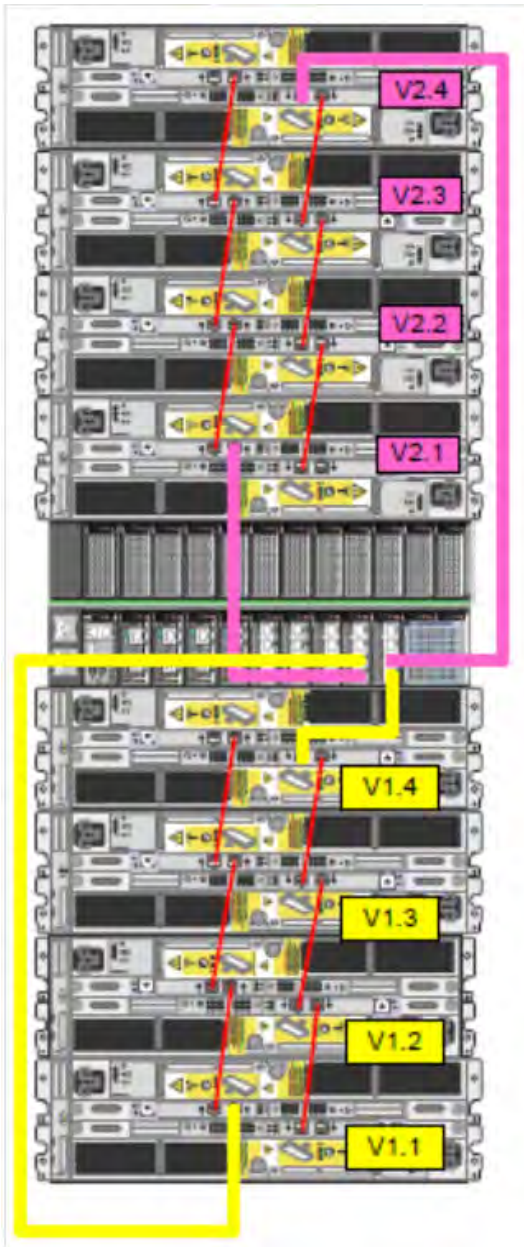


Figure 31. Recommended DD4200 cabling

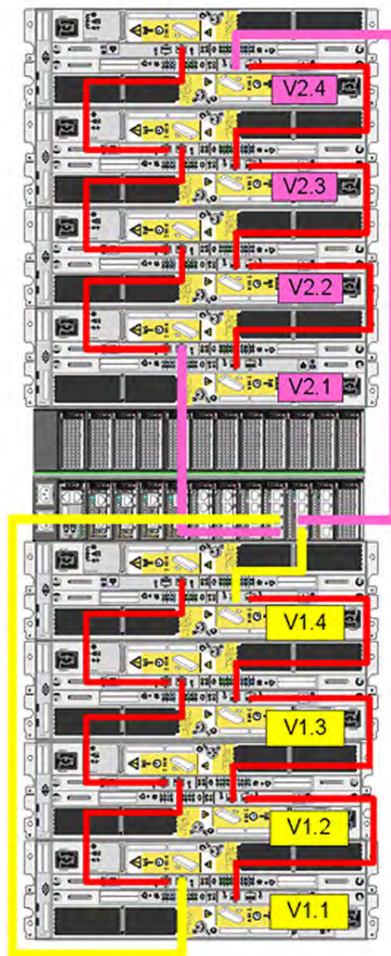


Figure 32. Recommended cabling for DD4200 integrated with Avamar



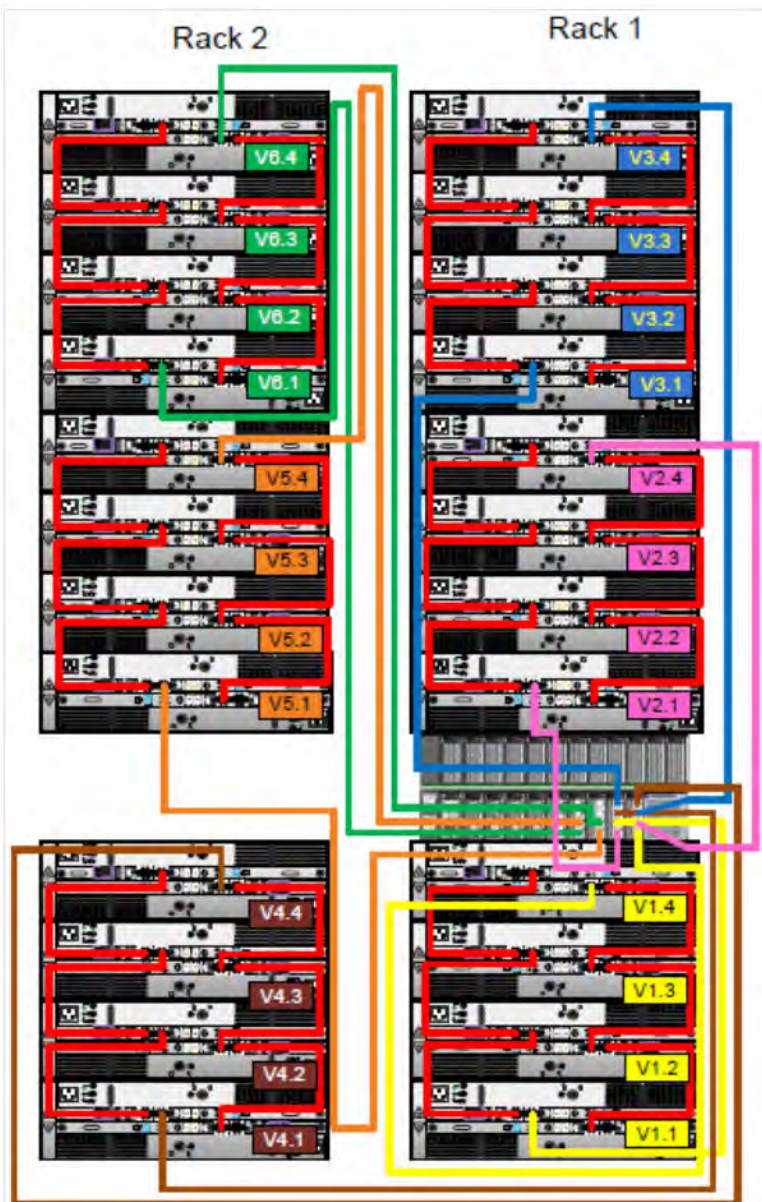


Figure 33. Recommended cabling for DD4200 system with extended retention software or DD Cloud Tier

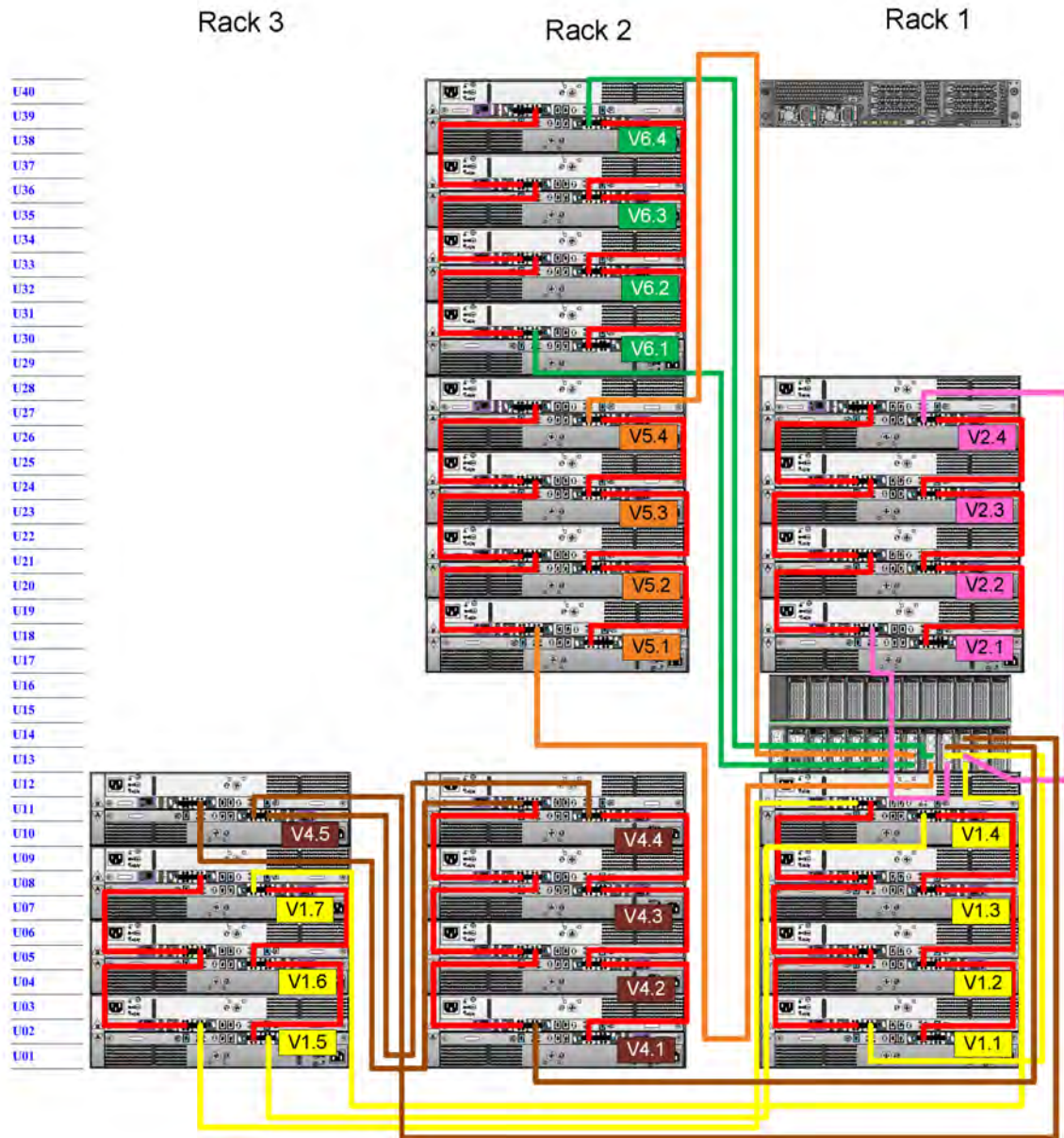


Figure 34. Recommended cabling for DD4200 with extended retention and integrated with Avamar

## DD4200 and DS60 shelf guidelines

The Data Domain system rediscovers newly configured shelves after it restarts. You can power off the system and recable shelves to any other position in a set, or to another set. To take advantage of this flexibility, you need to follow these rules before making any cabling changes:

- Do not exceed the maximum shelf configuration values for your Data Domain system as listed in the following table.
- For redundancy, the two connections from a Data Domain system to a set of shelves must use ports on different SAS I/O modules.
- Use the Installation and Setup Guide for your Data Domain system to minimize the chance of a cabling mistake.
- A Data Domain system cannot exceed its maximum raw external shelf capacity, regardless of added shelf capacity.
- ES30 SATA shelves must be on their own chain.
- If ES30 SAS shelves are on the same chain as a DS60, the maximum number of shelves on that chain is 5.

- DD OS 5.7.1 does not support HA with SATA drives.

**Table 21. DD4200 and DS60 shelf configuration**

DD system	Memory required (GB)	SAS cards/port per card	DS60 support (TB)	Max shelves per set	Max number of sets	Max external capacity available (TB) <sup>1</sup>	Max RAW external capacity (TB)
DD4200	128	2x4	SAS 45	1	4	192	240
DD4200 ER <sup>2</sup>	128	4x4	SAS 45	2	8	384	480

**NOTE:** An entry of 45 corresponds to DS60-3 models and an entry of 60 corresponds to DS60-4 models.

1. This column only counts drives that have user data in the shelves. For example, a DS60 4-240 has 192TB.

2. With Extended Retention software.

## Single phase power connections for 40U-P (current racks)

The following figures show single phase power connections for several Data Domain systems.



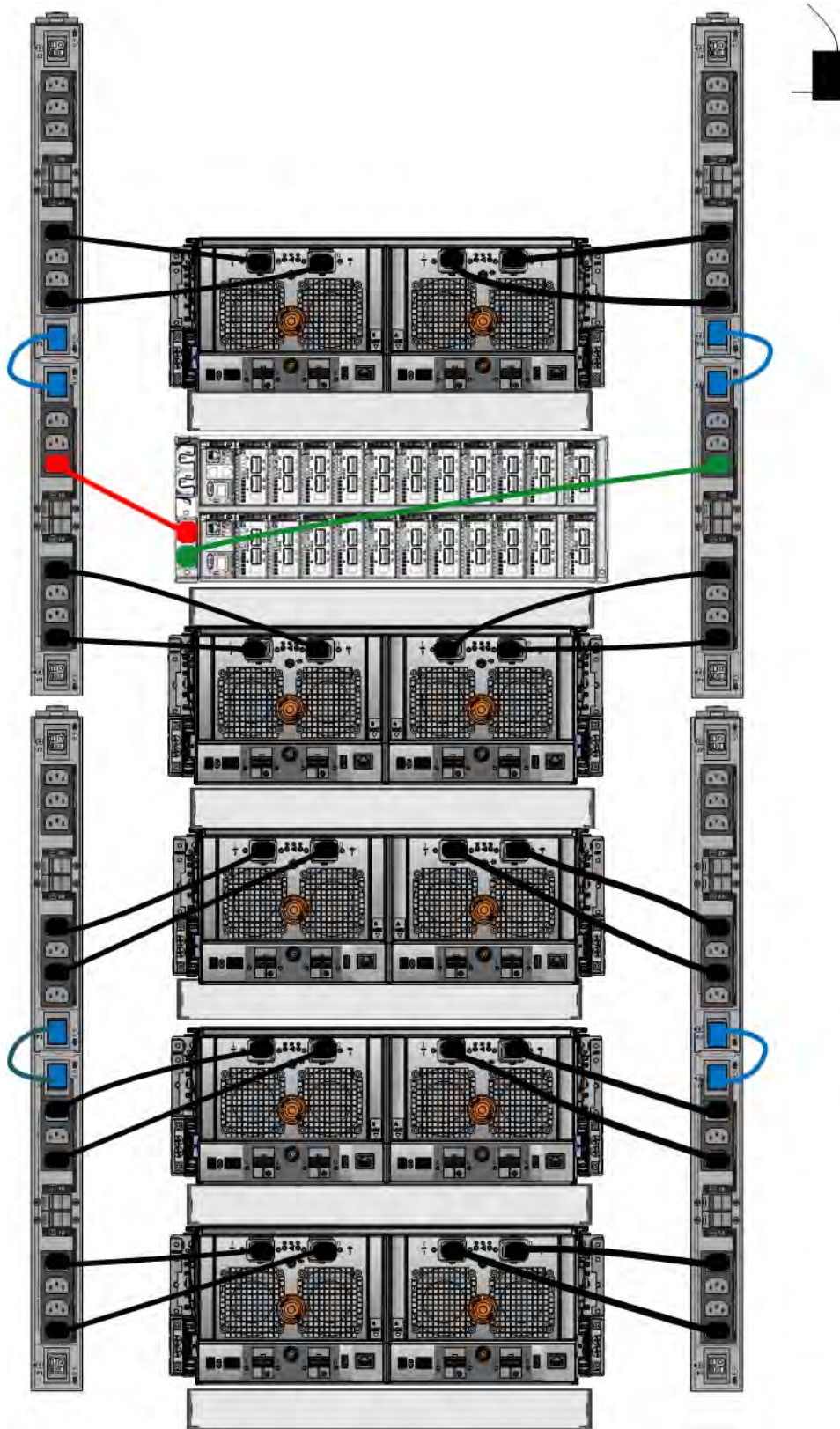


Figure 35. Single phase power connections for DD4200, DD4500, and DD7200 systems

### 3-phase power connections for 40U-P (current racks)

Some environments use 3-phase power for 40U-P racks used for several Data Domain systems. In those situations it is desirable to balance the current draw across all 3 phases. The recommended 3-phase power cabling attempts to do that, but an optimal

configuration is dependent on the specific installation. The following figures show recommended 3-phase power connections for several Data Domain systems.

**NOTE:** The next few diagrams show recommended 3-phase delta power connections.

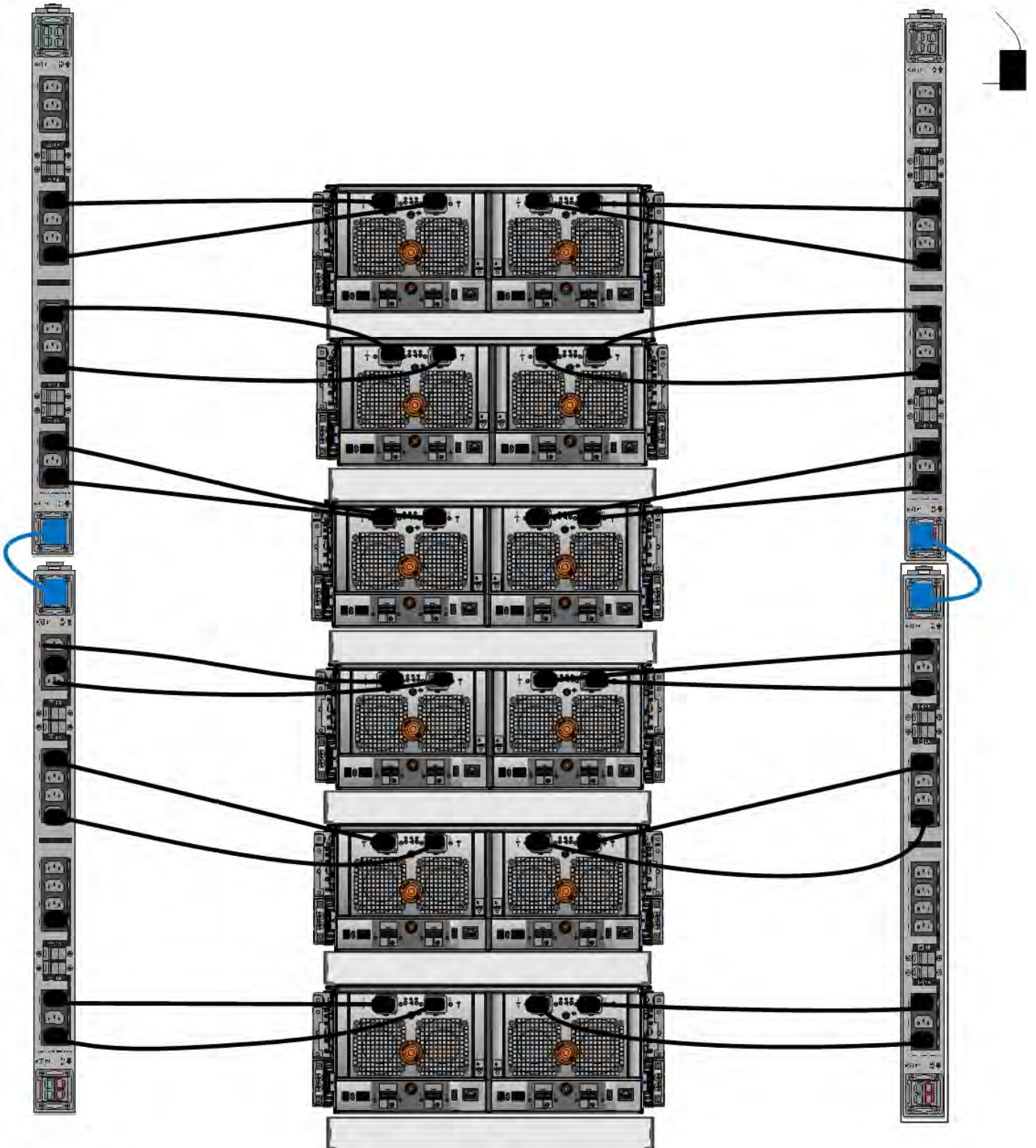


Figure 36. 3-phase delta power connections for DS60 expansion shelves (full-racked)



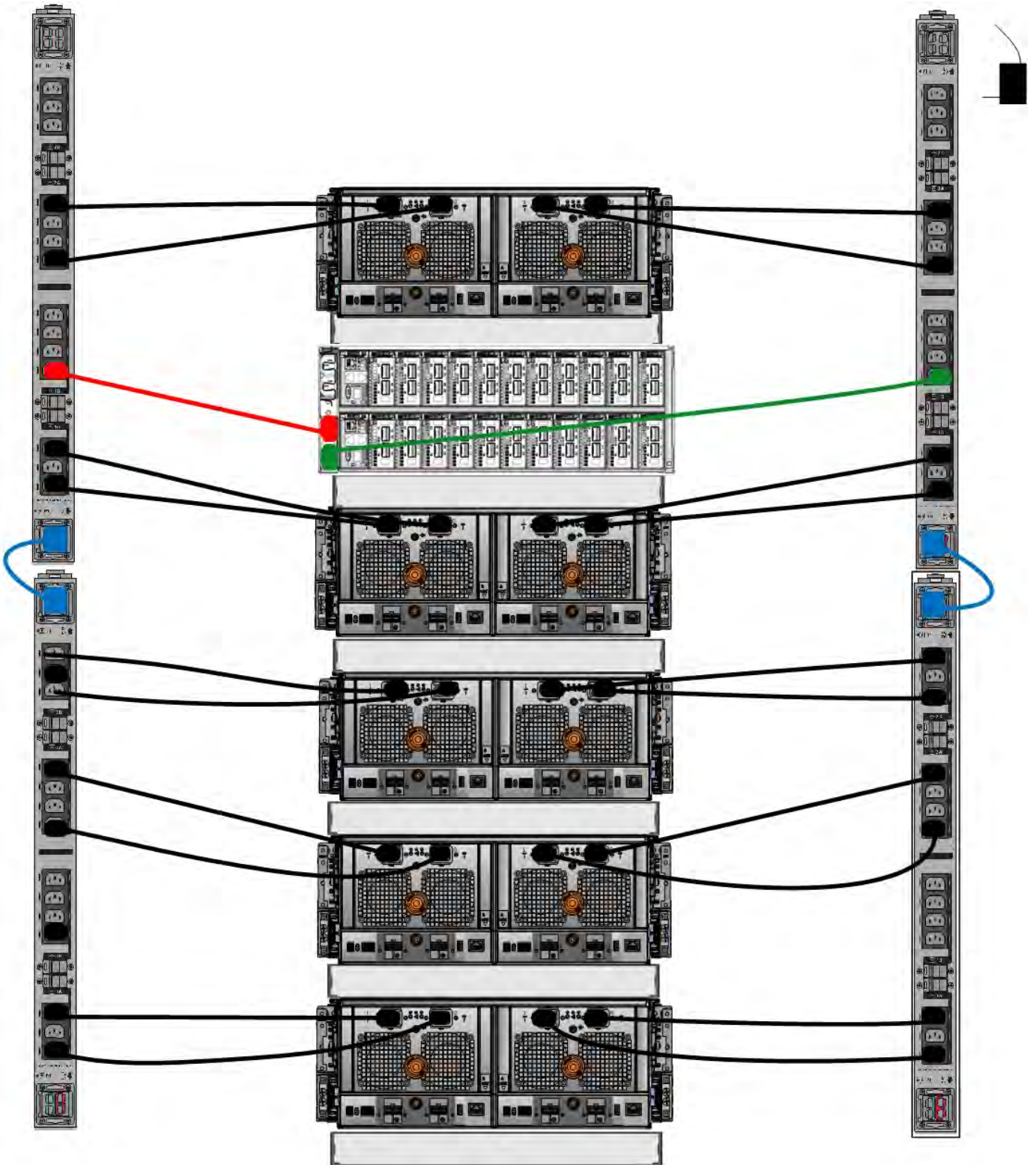


Figure 37. 3-phase delta power connections for DD4200, DD4500, and DD7200 systems

**NOTE:** The next few diagrams show recommended 3-phase wye power connections.

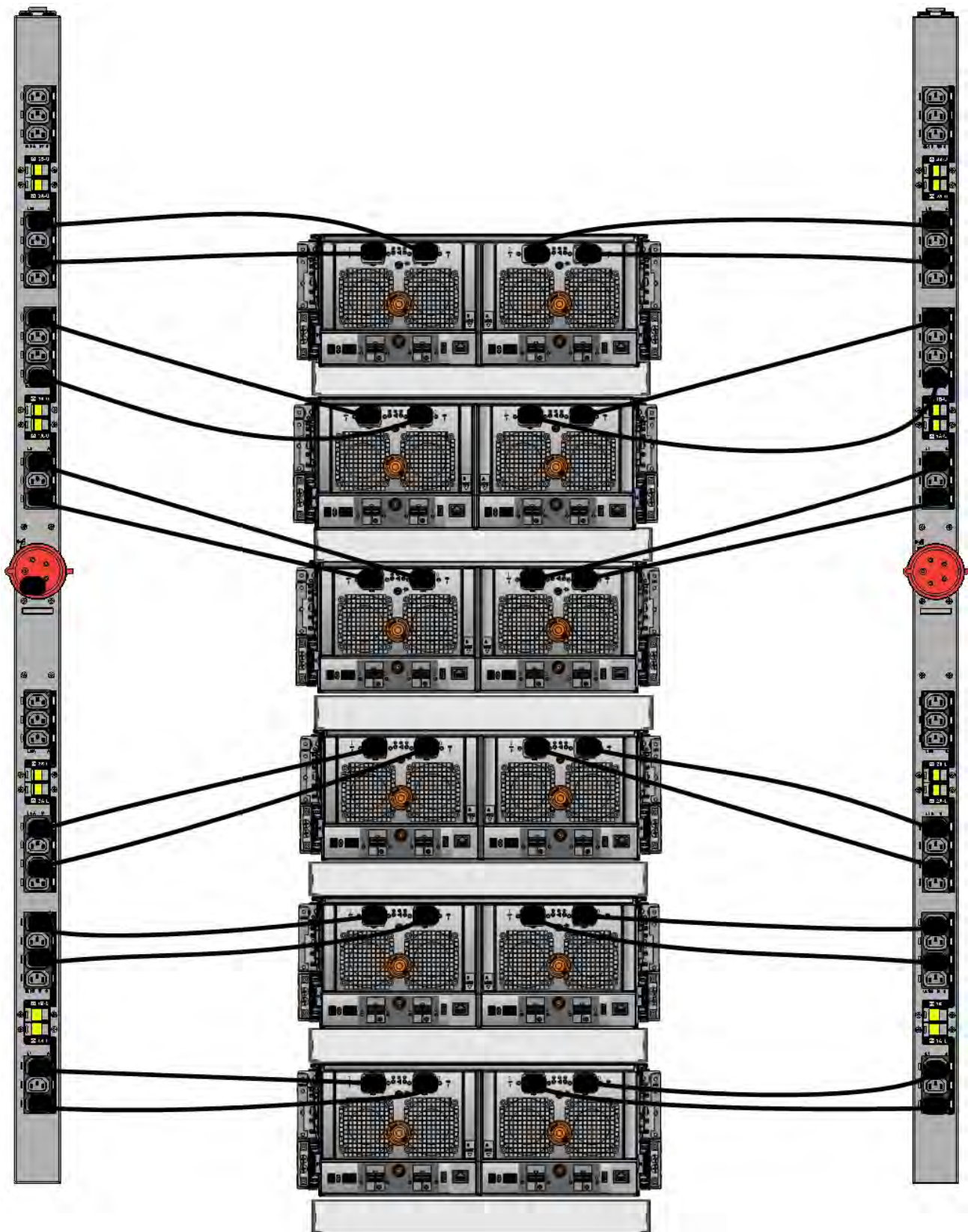


Figure 38. 3-phase wye power connections for DS60 expansion shelves (full-racked)



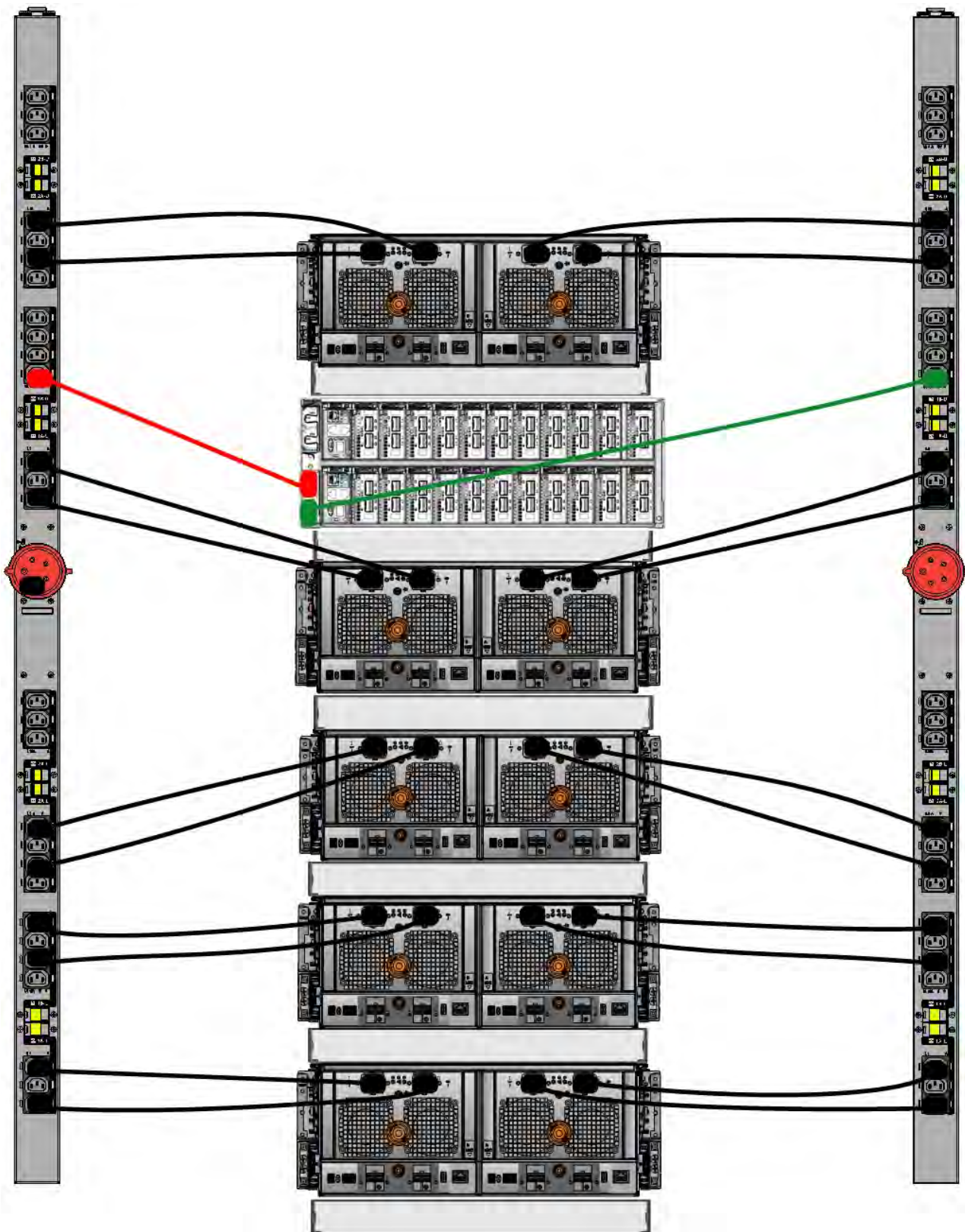


Figure 39. 3-phase wye power connections for DD4200, DD4500, and DD7200 systems

## DS60 and DD4200 cabling

There are a few rules that must be followed when adding a mixture of DS60 and other shelf types to your system.



 **CAUTION:** If a system does not follow all these rules, it is not a legitimate configuration.

Prerequisites:

- You cannot exceed the maximum amount of usable capacity displayed in cabling table for each system.
- You cannot exceed the maximum number of shelves displayed in cabling table for each system.
- You cannot connect more than two DS60 shelves in a single set.

**Table 22. Minimum and maximum configurations**


System	Appliance maximum	Minimum appliance shelf count
DD4200	192 TB	1

Mixing DS60, ES30, and ES20 shelves:


The non-Extended Retention versions of these systems all support four chains.

Extra planning and reconfiguration may be required to add DS60 shelves to system with ES20 shelves, ES30 SATA shelves, or a combination of shelves.

- The ES20 shelves must be on their own set. Minimize the ES20 set count by combining up to four ES20s per set.
- ES30 SATA shelves must also be on their own sets. Minimize the ES30 set count by combining up to five ES30s per set. If required, combine up to seven ES30 SAS shelves per set to minimize the set count.
- A set can contain a maximum of two DS60 shelves and, if required because of other restrictions, add ES30 SAS shelves up to a maximum of five shelves in that set.

 **NOTE:** The configuration rules apply also to Extended Retention systems.

The following figures show cabling for base systems and systems with the Extended Retention software.

 **NOTE:** It is recommended that the DS60 shelf with the greater number of drives should always be placed in the bottom position.

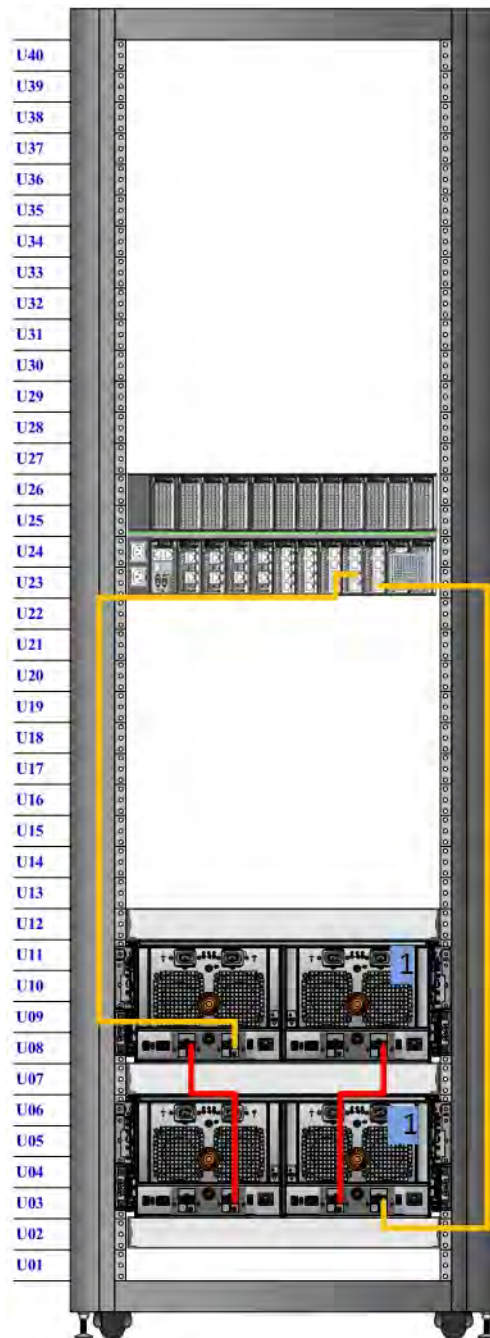


Figure 40. Recommended cabling for DD4200 (3TB drives)

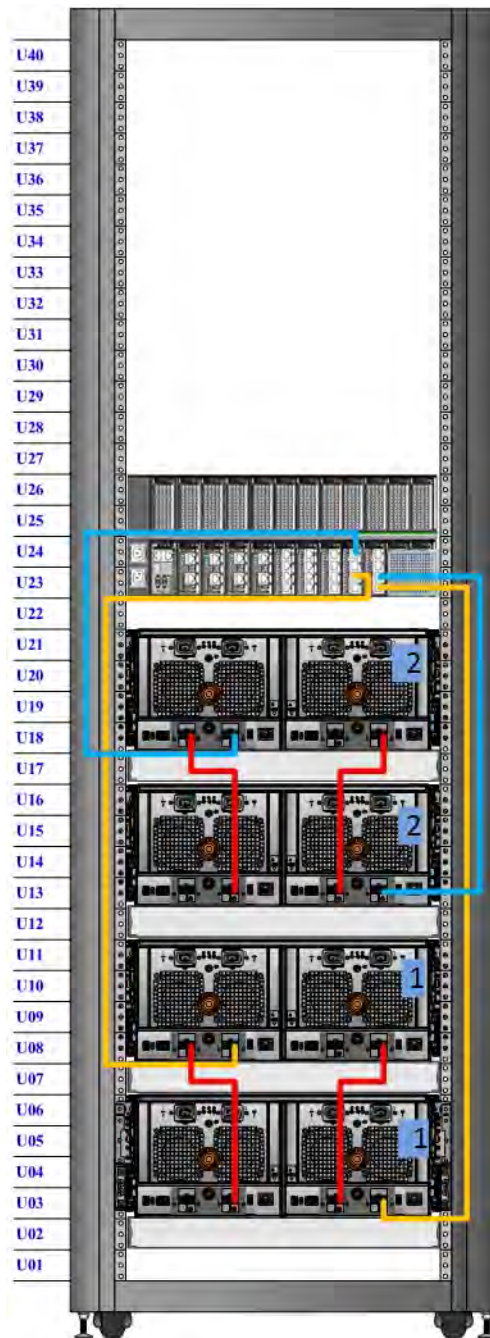


Figure 41. Recommended cabling for DD4200 (3TB drives) with Extended Retention Software

# DD4500

This chapter contains the following topics:

**Topics:**

- [DD4500 system features](#)
- [DD4500 system specifications](#)
- [DD4500 storage capacity](#)
- [Front Panel](#)
- [Back Panel](#)
- [I/O modules and slot assignments](#)
- [Internal system components](#)
- [DD4500 and ES30 shelf guidelines](#)
- [DD4500 and DS60 shelf guidelines](#)

## DD4500 system features

The table summarizes the DD4500 system features.

**Table 23. DD4500 system features**

Feature		DD4500
Rack height		4U, supported in four-post racks only
Rack mounting		Rack mount kit included with each system. Adjustable between 24 - 36 in. (60.9 - 76.2 cm).
Power		1 +1 redundant, hot-swappable power units
Processor		Two 8-core processors
NVRAM		One 4-GB NVRAM module (and companion BBU) for data integrity during a power outage
Fans		Hot-swappable, redundant, 5
Memory		8 x 8 GB DIMM + 8 x 16 GB DIMM (192 GB)
Internal drives		SSD drives, 3 x 200 GB (base 10)
I/O module slots		Nine replaceable I/O module (Fibre Channel, Ethernet, and SAS) slots, one BBU, one NVRAM, and one Management module slot. See <a href="#">Management module and interfaces</a> on page 45 and <a href="#">I/O modules and slot assignments</a> on page 47.
Supported capacity	Non-extended retention	12 x 2-TB or 8 x 3-TB shelves adding up to 285 TB of usable external capacity.
	DD Cloud Tier	285 TB of Active Tier capacity, and 570 TB of Cloud Tier capacity. 2 x 4 TB shelves are required to store DD Cloud Tier metadata.
	DD Extended Retention	32 shelves adding up to 570 TB of usable external capacity. If lower-capacity 1 TB-drive-based shelves are used, the maximum configuration will also be limited by a maximum shelf count of 40.

## DD4500 system specifications

**Table 24. DD4500 system specifications**

Model	Watts	BTU/hr	Power	Weight	Width	Depth	Height
DD4500	800	2730	800	80 lb / 36.3 kg	17.5 in (44.5 cm)	33 in (84 cm)	7 in (17.8 cm)

**Table 25. System operating environment**

Operating Temperature	50° to 95° F (10° to 35° C), derate 1.1° C per 1000 feet, above 7500 feet up to 10,000 feet
Operating Humidity	20% to 80%, non-condensing
Non-operating Temperature	-40° to +149° F (-40° to +65° C)
Operating Acoustic Noise	Sound power, LWAd: 7.52 bels. Sound pressure, LpAm: 56.4 dB. (Declared noise emission per ISO 9296.)

## DD4500 storage capacity

The table lists the capacities of the systems. Data Domain system internal indexes and other product components use variable amounts of storage, depending on the type of data and the sizes of files. If you send different data sets to otherwise identical systems, one system may, over time, have room for more or less actual backup data than another.

**Table 26. DD4500 storage capacity**

System/ Installed Memory	Internal Disks (SATA SSDs)	Data Storage Space	External Storage <sup>1</sup>
DD4500 (2 SAS I/O modules) 192 GB	2.5 in. 3 @ 200 GB No User Data	285 TB	Up to a maximum of 12 x 2-TB or 8 x 3-TB shelves.
DD4500 with DD Cloud Tier <sup>1</sup> (3 SAS I/O modules) 192 GB	2.5 in. 3 @ 200 GB No User Data	<ul style="list-style-type: none"> <li>● 285 TB (Active Tier)</li> <li>● 96 TB (DD Cloud Tier metadata)</li> <li>● 570 TB (DD Cloud Tier)</li> </ul>	Up to a maximum of 12 x 2-TB or 8 x 3-TB shelves.  2x4-TB shelves for DD Cloud Tier metadata.
DD4500 with Extended Retention software <sup>1</sup> (4 SAS I/O modules) 192 GB	2.5 in. 3 @ 200 GB No User Data	570 TB	Up to a maximum of 24 x 2-TB or 16 x 3-TB shelves.

<sup>1</sup> The capacity will differ depending on the size of the external storage shelves used. This data based on ES30 shelves.

# Front Panel

The photo shows the hardware features and interfaces on the front of the system.

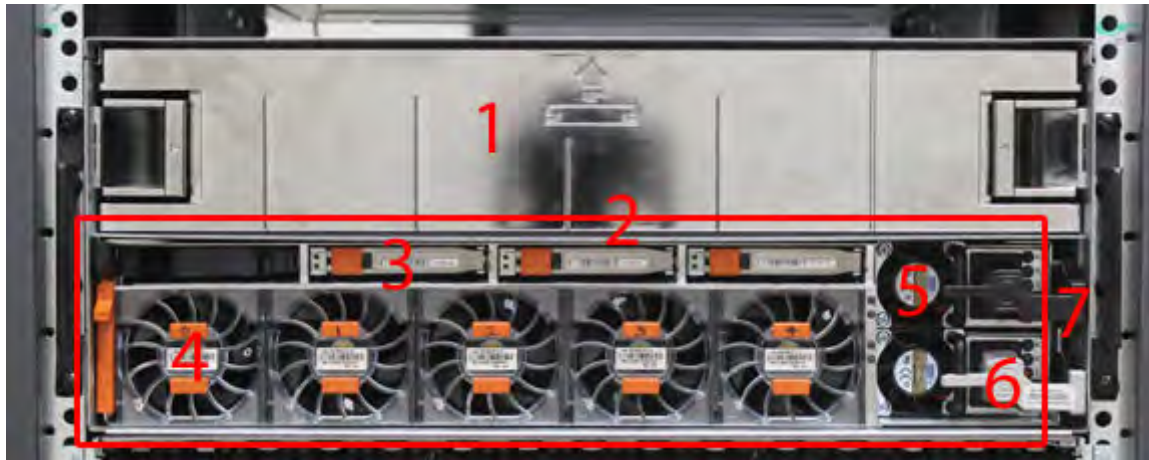


Figure 42. Front panel components

(1)	Filler panel
(2)	The red box indicates the system processor (SP) module
(3)	SSD drive #1
(4)	Fan #0
(5)	Power supply #B
(6)	AC power disconnect plug
(7)	AC power extender module

## Power supply units

A system has two power supply units, numbered A and B from the bottom up. Each power supply has its own integral cooling fan. Each power unit has three LEDs (see [System LED legend label](#) on page 43) that indicates the following states:

- AC LED: Glows green when AC input is good
- DC LED: Glows green when DC output is good
- Symbol “!”: Glows solid or blinking amber for fault or attention

The AC power plugs are located to the right of each power supply. These plugs are pulled to disconnect AC power to each power supply.

## AC power extender module

AC power entry is connected at the rear of the system. The AC power extender module provides power to the two power supplies on the front of the system. AC Power plugs are located in the front. The module is adjacent to the SP module and can be removed and replaced.



## Cooling Fans

A system contains five hot-swappable cooling fans in a 4+1 redundant configuration. The fans provide cooling for the processors, DIMMs, IO modules, and the management module. Each fan has a fault LED which causes the fan housing to glow amber. A system can run with one fan faulted or removed.

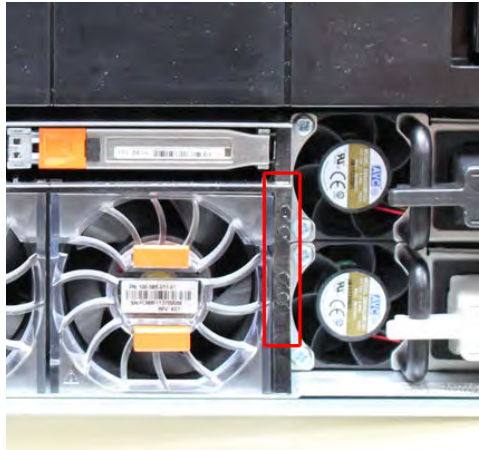
## Solid-state drives

A system contains three hot-swappable 2.5" solid-state drive (SSD) bays that are located in the front and on top of the fan modules. There are four drive bays, with the left-most bay containing a blank. The next drive to the right of the blank is SSD #1, the next is #2, and the right-most bay contains SSD #3. No user backup data is kept on the SSDs.

Each drive has a blue colored power LED and an amber fault LED.

## Front LED Indicators

The photo below indicates the location of the four system LEDs.



**Figure 43. System LEDs**

The next photo shows the location of the system LED legend label. [Power supply LEDs](#) on page 82 shows the power supply LEDs. Other front LEDs are shown in [Fan and SSD LEDs](#) on page 83. LED states are described in [LED status indicators](#) on page 83.

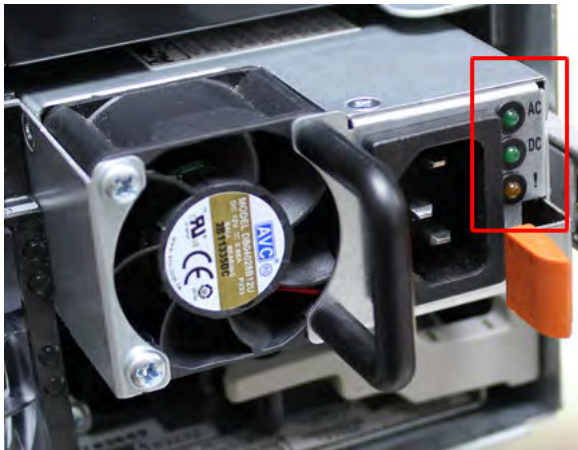


**Figure 44. System LED legend label**

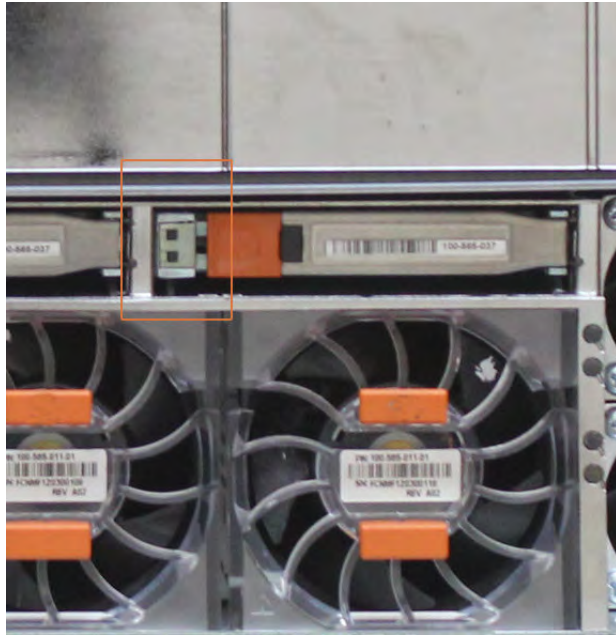
The power supply LEDs include:

- AC LED on top
- DC LED in the middle
- Failure LED on the bottom

**Figure 45. Power supply LEDs**



Each SSD has two LEDs as shown in the following figure. The lower left corner of the housing around each fan acts as an LED, glowing amber when the fan has failed.



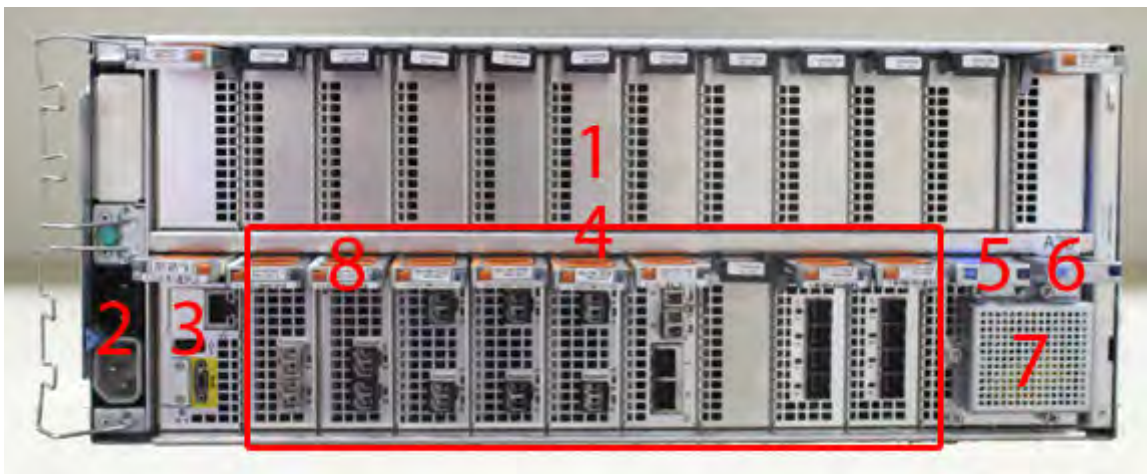
**Figure 46. Fan and SSD LEDs**

**Table 27. LED status indicators**

Part	Description or Location	State
System	Dot within a circle (top LED)	Blue indicates power on and normal operation.
System, SP fault	Exclamation point within a triangle	Dark indicates normal operation. Amber indicates failure.
System, chassis fault	Exclamation point within a triangle with a light below	Dark indicates normal operation. Yellow indicates a fault condition.
System	Marked out hand within a black square (bottom LED)	White warns not to remove the unit.
Power supply	AC LED	Steady green indicates normal AC power.
Power supply	DC LED	Steady green indicates normal DC power.
Power supply	Failure LED	Solid amber indicates a failed power supply.
SSD	Top LED	Solid blue, disk ready, blinks while busy.
SSD	Bottom LED	Dark indicates healthy. Solid amber indicates disk fail.
Fan	Fan housing	The fan housing glows an amber color during fan failure.

## Back Panel

The photo shows the hardware features and interfaces on the back of the system.



**Figure 47. Features on rear of chassis**

1. Upper level contains all blanks
2. AC power extender module
3. Management module (slot Mgmt A)
4. Red box indicating I/O modules (slots 0-8)
5. Battery backup (BBU in slot 9)
6. NVRAM module (slot 10)
7. Cage covering the BBU and NVRAM combination module
8. I/O LED at the end of each I/O module handle
9. Location of serial number label/tag

**NOTE:** For modules containing multiple ports, the bottom port is numbered as zero (0) with numbers increasing going upward.

## I/O module LEDs

Each I/O module ejector handle contains a bi-colored LED. Green indicates normal function, while an amber color indicates a fault condition.

## Management module and interfaces

The management module is on the left-most side when facing the back of the system, in slot Mgmt A. The process to remove and add a management module is the same as the I/O modules, however, the management module can only be accommodated in Mgmt A slot.

The management module contains one external LAN connection for management access to the SP module. One micro DB-9 connector is included to provide the console. A USB port is provided for use during service of the system to allow booting from a USB flash device.



**Figure 48. Interfaces on the management module**

- 1 - Ethernet port
- 2 - USB port
- 3 - Micro serial port

# I/O modules and slot assignments

The table shows the I/O module slot assignments for the systems. See [Features on rear of chassis](#) on page 45 for a view of the slot positions on the back panel and [Top view of SP module with SP cover removed](#) on page 49 for a top view.

**Table 28. DD4500 slot assignments**

Slot Number	DD4500	DD4500 with Extended Retention Software	DD4500 with DD Cloud Tier
MGMT A	Management module	Management module	Management module
0	Fibre Channel (FC), Ethernet or empty	FC, Ethernet or empty	FC, Ethernet or empty
1	FC, Ethernet or empty	FC, Ethernet or empty	FC, Ethernet or empty
2	FC, Ethernet or empty	FC, Ethernet or empty	FC, Ethernet or empty
3	FC, Ethernet or empty	FC, Ethernet or empty	FC, Ethernet or empty
4	Ethernet or empty	Ethernet or empty	Ethernet or empty
5	Ethernet or empty	SAS	Ethernet or empty
6	Empty	SAS	SAS
7	SAS	SAS	SAS
8	SAS	SAS	SAS
9	BBU	BBU	BBU
10	NVRAM	NVRAM	NVRAM

## Slot addition rules

- A maximum of six optional I/O modules (FC plus Ethernet) are allowed in systems without Extended Retention software, and a maximum of five optional I/O modules (FC plus Ethernet) are allowed in systems with Extended Retention software.
- Additional FC modules should be installed in numerically increasing slot numbers immediately to the right of the existing FC modules, or starting in slot 0 if no FC modules were originally installed. A maximum of four FC modules are allowed in a system.
- Additional Ethernet modules should be installed in numerically decreasing slot numbers immediately to the left of the existing Ethernet modules or starting in slot 4 if no Ethernet modules were originally installed. For systems without Extended Retention software, a maximum of six (limited to four of any one type) Ethernet modules can be present. For systems with Extended Retention software, a maximum of five (limited to four of any one type) Ethernet modules can be present.
- All systems include two SAS modules in slots 7 and 8. Systems with Extended Retention software must have two additional SAS modules in slots 5 and 6.
- For systems without Extended Retention software, if adding I/O modules results in the allowed maximum of six I/O modules present, slot 5 is used. Slot 5 is only used for an Ethernet module. Adding FC modules in this specific case require moving an existing Ethernet module to slot 5. Other than this specific case, it is not recommended to move I/O modules between slots.
- Adding Extended Retention software to a system includes adding two SAS modules in slots 5 and 6. If the system originally had the maximum of 6 optional I/O modules, the I/O module in slot 5 must be permanently removed from the system.

## Fibre Channel (FC) I/O Module Option

An FC I/O module is a dual-port Fibre Channel module. The optional virtual tape library (VTL) feature requires at least one FC I/O module. Boost over Fiber Channel is optional and the total FC HBAs cannot exceed more than allowable Fibre Channel cards per controller.

## Ethernet I/O Module Options

The available Ethernet I/O modules are:

- Dual Port 10GBase-SR Optical with LC connectors

- Dual Port 10GBase-CX1 Direct Attach Copper with SPF+ module
- Quad Port 1000Base-T Copper with RJ-45 connectors
- Quad port 2 port 1000Base-T Copper (RJ45) /2 port 1000Base-SR Optical



# Internal system components

The photo shows the system with the system processor (SP) module that is removed from the chassis and the SP cover removed.



Figure 49. Top view of SP module with SP cover removed

- 1 - Front of system
- 2 - Four groups of 4 DIMM cards

## DIMM modules

DD4500 systems contain 8 x 8 GB and 8 x 16 GB of memory DIMM. DIMMs must be in specific slots based on DIMM size.

## DD4500 and ES30 shelf guidelines

The Data Domain system rediscovers newly configured shelves after it restarts. You can power off the system and recable shelves to any other position in a set, or to another set. To take advantage of this flexibility, you need to follow these rules before making any cabling changes:

- Do not exceed the maximum shelf configuration values for your Data Domain system as listed in the following table below.
- Use the Installation and Setup Guide for your Data Domain system to minimize the chance of a cabling mistake.
- A Data Domain system cannot exceed its maximum raw external shelf capacity, regardless of added shelf capacity.
- ES30 SATA shelves must be on their own chain.

### **i** NOTE:

- ES30 SAS shelves must be running DD OS 5.4 or later.
- ES30-45 SATA shelves must be running DD OS 5.4 or later.
- DD OS 5.7 and later support 4TB drives.



**Table 29. DD4500 and ES30 shelf configuration**

DD system	Memory required (GB)	SAS cards/port per card	ES30 support (TB)	Max shelves per set	Max number of sets	Max external capacity available (TB) <sup>1</sup>	Max RAW external capacity (TB) <sup>2</sup>
DD4500	192	2x4	SAS 30, 45, 60; SATA 15, 30, 45 <sup>5</sup>	5 <sup>6</sup>	4	288	384
DD4500 ER <sup>3, 4</sup>	192	4x4	SAS 30, 45, 60; SATA 15, 30, 45 <sup>5</sup>	7	8	576	768
DD4500 w/ DD Cloud Tier	192	3x4	SAS 30, 45, 60; SATA 15, 30, 45 <sup>5</sup>	7	8	288 (max), additional 96 SAS dedicated to DD Cloud Tier	384 (max), additional 120 SAS dedicated to DD Cloud Tier

1. This figure only counts drives that have user data in the shelves.

2. The raw capacity of an ES30 is 125% of the available capacity.

3. The maximum shelf count for any specific drive/shelf size might be less than the product of max shelves x max shelves per set.

4. With Extended Retention software.

5. ES30-45 (SATA) is only supported with DD OS 5.4 or later.

6. 5 shelves maximum with ES30, 4 is the recommended maximum.

## Single phase power connections for 40U-P (current racks)

The following figures show single phase power connections for several Data Domain systems.

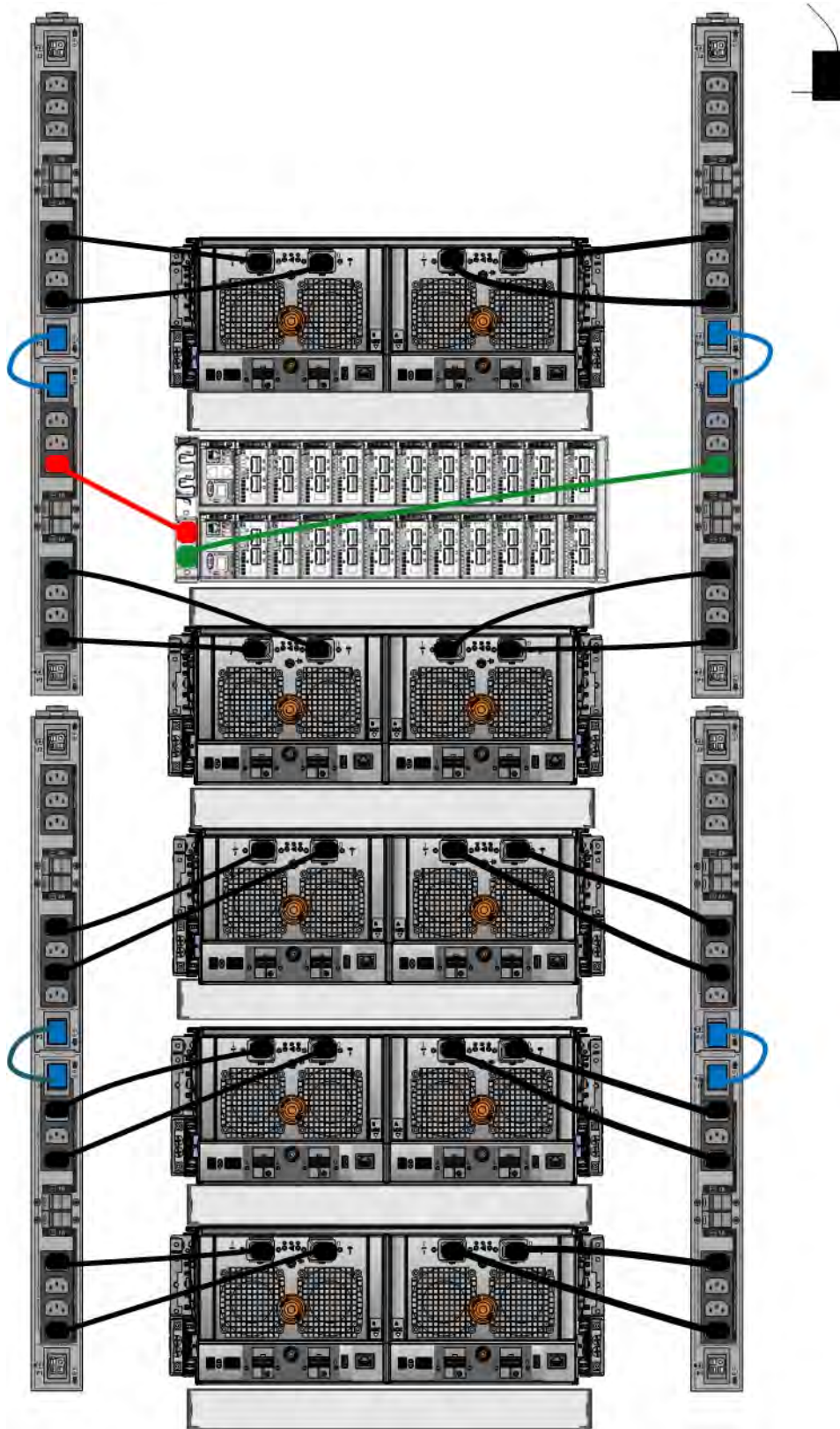


Figure 50. Single phase power connections for DD4200, DD4500, and DD7200 systems

## Cabling shelves

**NOTE:**

- Before cabling the shelves, physically install all shelves in the racks. Refer to the rail kit installation instructions included with the ES30 shelf for rack mounting.
- The documentation refers to two SAS HBAs. If only one HBA is allowed in a system, then use another port as defined later for that specific system.
- On an HA system, add cables from the second node to open ports at the end of the sets. The ports on the second node must connect to the same sets as the corresponding ports on the first node.

Ports on the system's SAS HBA cards connect directly to a shelf controller's host port. For redundancy, you need to create dual paths by using a port on one SAS HBA card to connect to one shelf controller in each shelf set, and a port on another SAS HBA card to connect to another shelf controller in the same shelf set. With dual paths, if one SAS HBA card fails, the shelf is still operational. However, in the unlikely event any single shelf becomes completely disconnected from power or SAS cables and becomes disconnected from a previously operational shelf, the file system goes down and the shelf is not operational. This is considered a double failure.

There are two kinds of configurations: one shelf in a set or multiple shelves in a set.

## ES30 and DD4500 cabling

There are a few rules that must be followed when adding a mixture of ES20, ES30 SATA, and ES30 SAS shelves to your system. If a system does not follow ALL of these rules it is not a legitimate configuration.

Prerequisites:

- Follow the minimum and maximum shelf capacity configuration provided in the table.
- You cannot have ES20 and ES30 shelves in the same set.
- You cannot have ES30 SATA and ES30 SAS shelves in the same set.
- You cannot exceed the maximum amount of raw capacity displayed in the product's cabling table.
- The maximum number of shelves displayed in the product's cabling table cannot be exceeded.
- You cannot have more than four ES20s in a single set (maximum preference is three).
- You cannot have more than five ES30s in a single set (maximum preference is four).
- You can have a maximum of seven ES30s for systems with Extended Retention software.
- There are no specific placement or cabling requirements for the metadata shelves for DD Cloud Tier configurations. These shelves can be installed and cabled the same way as standard ES30 shelves.

**i** **NOTE:** An ES20 requires more power than an ES30. Ensure that your rack is configured to handle the power needs.

The tables below show how to configure a mixed system. To use the tables, go to the appropriate system. Then find the number of ES20s that are to be configured in the first column. The next column defines the number of ES20 sets. If there are multiple rows with the same number of ES20s then pick the row with the appropriate number of ES20 SATA shelves. The next column in that row defines the number of sets of ES30 SATA shelves. Finally, there may be entries for the number of desired ES30 SAS shelves and the number of sets to be used.

If the combinations of shelves exceed the supported usable storage, there may not be an entry. The entries are based on the smallest usable storage per shelf type (12TB for ES20, 12 TB for ES30 SATA, and 24TB for ES30 SAS). Always check that the sum of the usable storage of all of the shelves does not exceed the supported usable storage of the configuration.

**Table 30. Minimum and maximum configurations**

System	Minimum appliance shelf count	Maximum appliance shelf count	DD Cloud Tier systems in TB	Extended Retention systems (ER) in TB	Max shelves for ER
4500 (288)	2	20	<ul style="list-style-type: none"> <li>• 285</li> <li>• 120 for metadata</li> </ul>	<ul style="list-style-type: none"> <li>• DD OS 5.4 and earlier: 1152</li> <li>• DD OS 5.5 and later: 576</li> </ul>	40

Systems without Extended Retention or DD Cloud Tier all support four chains. The following tables show combinations of ES20 and ES30 shelves. For combinations of any two types of shelves, these tables can be used as a guide.

**Table 31. DD4500 cabling information**

DD4500					
ES20	ES20 chains	ES30 SATA	ES30 SATA chains	ES30 SAS	ES30 SAS chains

**Table 31. DD4500 cabling information (continued)**

DD4500					
13-16	4	0	0	0	0
9-12	3	1-5	1	0	0
9-12	3	0	0	1-5	1
5-8	2	1-5	1	1-5	1
5-8	2	6-8	2	0	0
5-8	2	0	0	1-5	1
5-8	2	0	0	6-10	2
1-4	1	9-12	3	0	0
1-4	1	5-8	2	1-5	1
1-4	1	1-4	1	1-5	1
1-4	1	1-4	1	6-10	2
1-4	1	0	0	1-4	1
1-4	1	0	0	5-8	2
1-4	1	0	0	9-11	3
0	0	16-21	4	0	0
0	0	11-15	3	1-5	1
0	0	6-10	2	1-4	1
0	0	6-10	2	5-9	2
0	0	1-5	1	1-4	1
0	0	1-5	1	5-8	2
0	0	1-5	1	9-11	3
0	0	0	0	1-4	1
0	0	0	0	5-8	2
0	0	0	0	9-12	3

The following figures show cabling for base systems, systems with the Extended Retention software option, and systems integrated with an Avamar system.

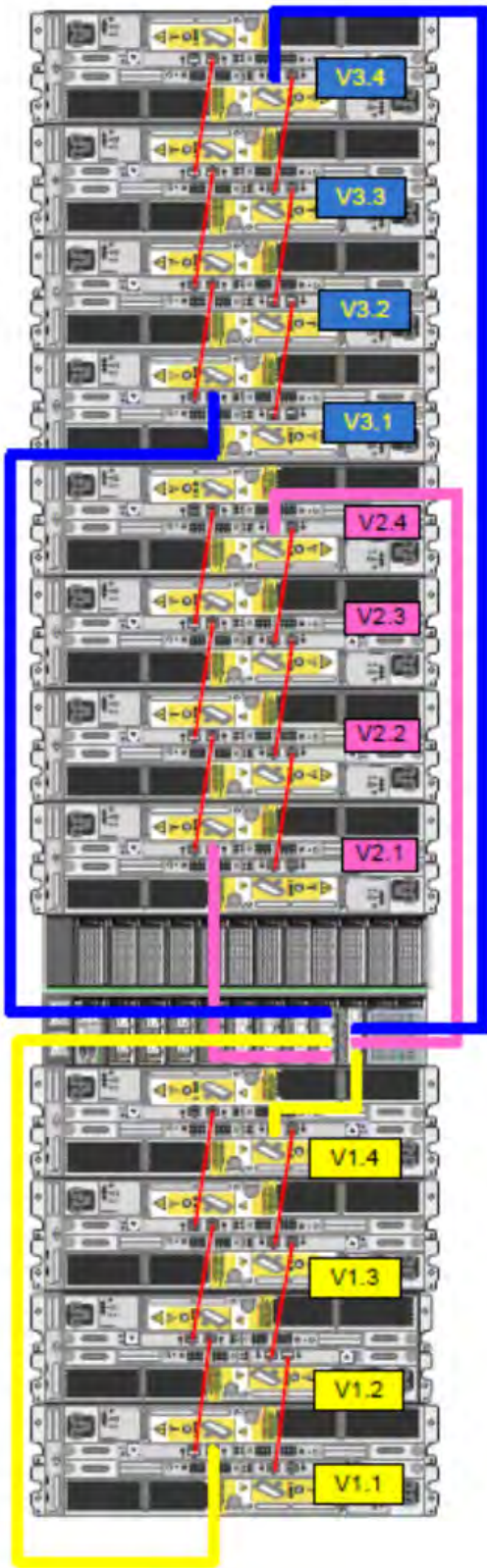


Figure 51. Recommended DD450 cabling



Rack 2

Rack 1

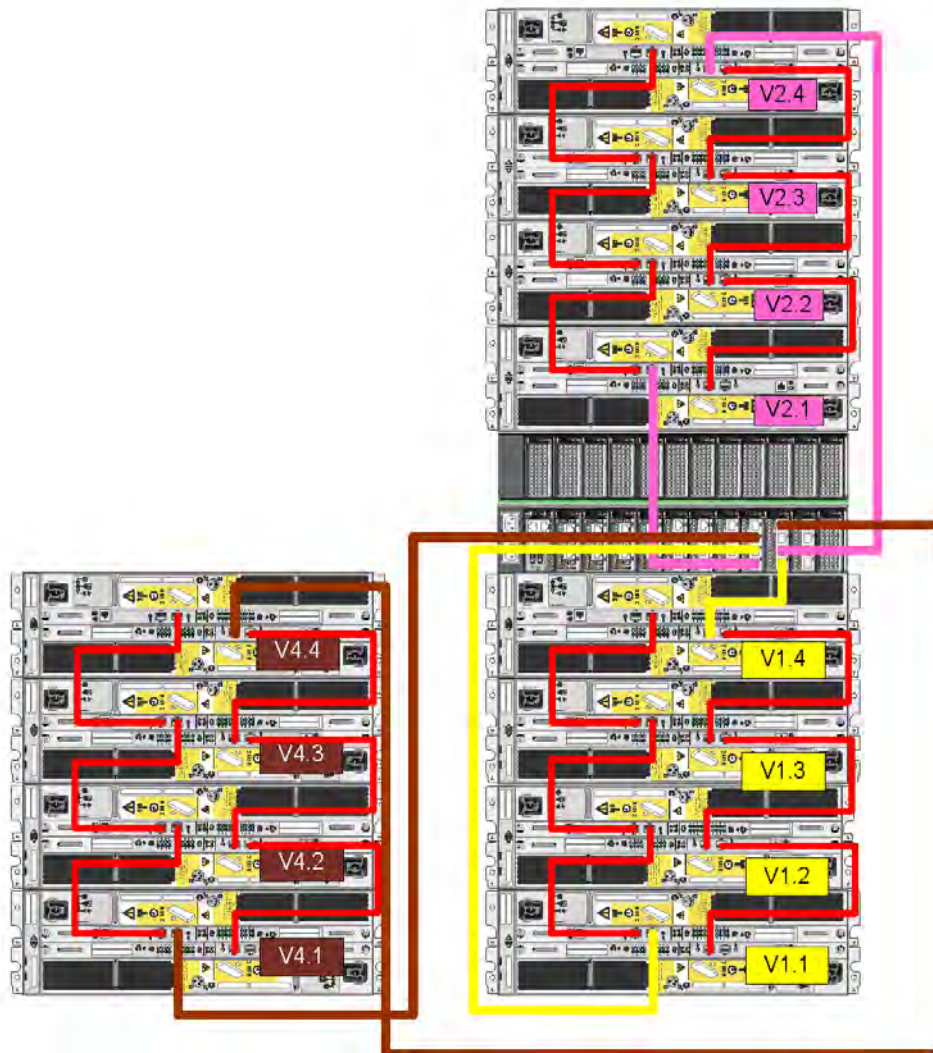


Figure 52. Recommended cabling for DD4500 integrated with Avamar

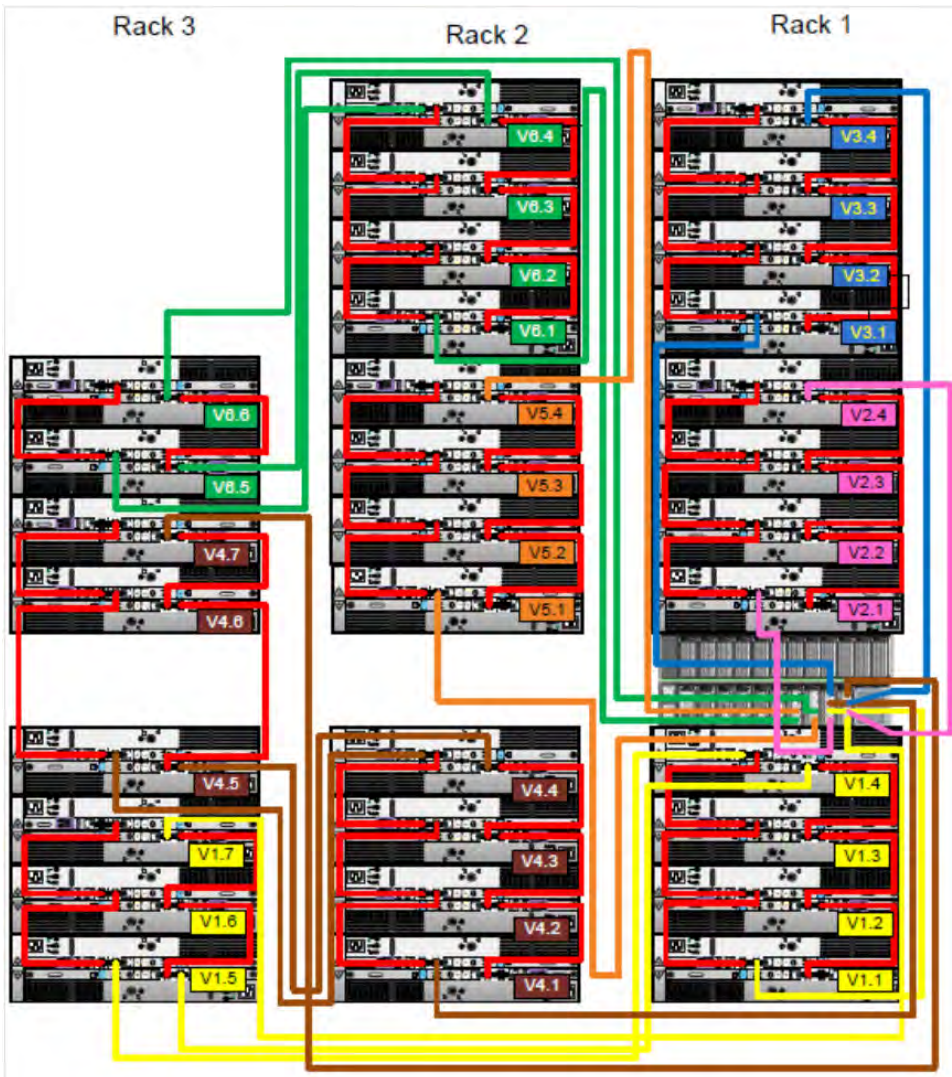


Figure 53. Recommended cabling for DD4500 with extended retention software or DD Cloud Tier



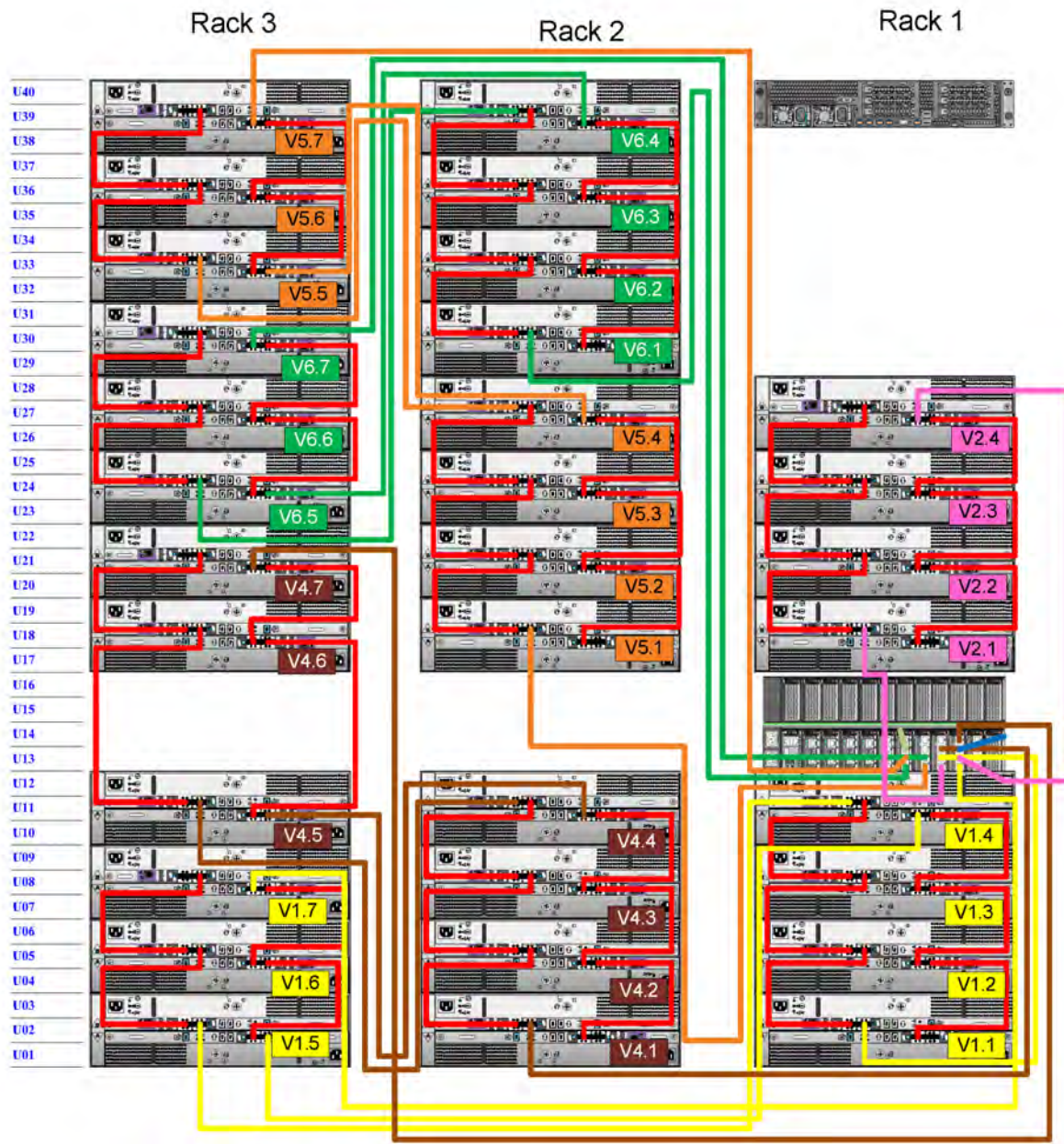


Figure 54. Recommended cabling for DD4500 with extended retention and integrated with Avamar

## DD4500 and DS60 shelf guidelines

The Data Domain system rediscovers newly configured shelves after it restarts. You can power off the system and recable shelves to any other position in a set, or to another set. To take advantage of this flexibility, you need to follow these rules before making any cabling changes:

- Do not exceed the maximum shelf configuration values for your Data Domain system as listed in the following table.
- For redundancy, the two connections from a Data Domain system to a set of shelves must use ports on different SAS I/O modules.
- Use the Installation and Setup Guide for your Data Domain system to minimize the chance of a cabling mistake.
- A Data Domain system cannot exceed its maximum raw external shelf capacity, regardless of added shelf capacity.
- ES30 SATA shelves must be on their own chain.



- If ES30 SAS shelves are on the same chain as a DS60, the maximum number of shelves on that chain is 5.
- DD OS 5.7.1 does not support HA with SATA drives.

**Table 32. DD4200 and DS60 shelf configuration**

DD system	Memory required (GB)	SAS cards/port per card	DS60 support (TB)	Max shelves per set	Max number of sets	Max external capacity available (TB) <sup>1</sup>	Max RAW external capacity (TB)
DD4500	192	2x4	SAS 45, 60	2	4	288	360
DD4500 ER <sup>2</sup>	192	4x4	SAS 45, 60	2	8	576	720

**NOTE:** An entry of 45 corresponds to DS60-3 models and an entry of 60 corresponds to DS60-4 models.

1. This column only counts drives that have user data in the shelves. For example, a DS60 4-240 has 192TB.

2. With Extended Retention software.

## Single phase power connections for 40U-P (current racks)

The following figures show single phase power connections for several Data Domain systems.

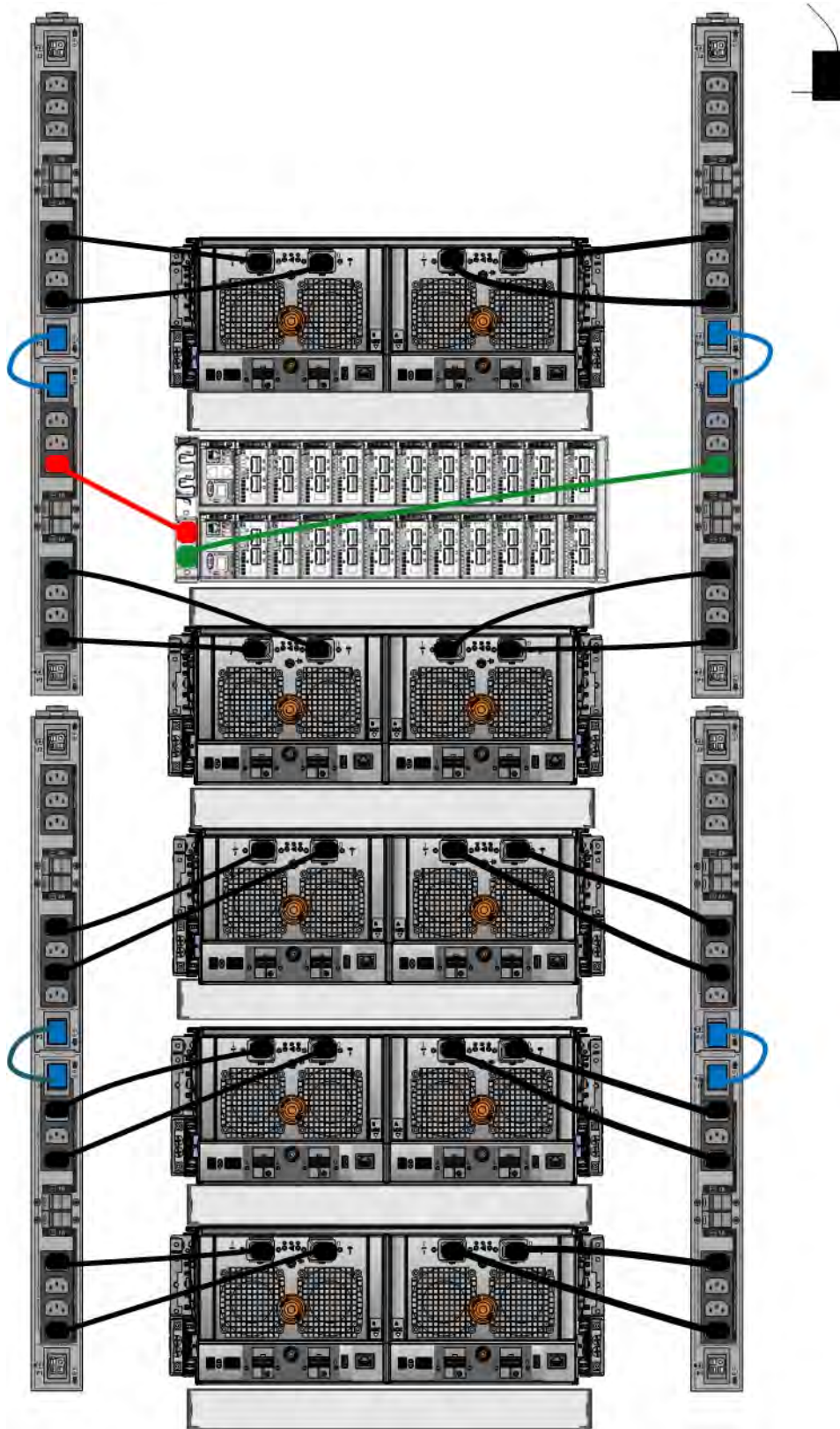


Figure 55. Single phase power connections for DD4200, DD4500, and DD7200 systems

### 3-phase power connections for 40U-P (current racks)

Some environments use 3-phase power for 40U-P racks used for several Data Domain systems. In those situations it is desirable to balance the current draw across all 3 phases. The recommended 3-phase power cabling attempts to do that, but an optimal

configuration is dependent on the specific installation. The following figures show recommended 3-phase power connections for several Data Domain systems.

**NOTE:** The next few diagrams show recommended 3-phase delta power connections.

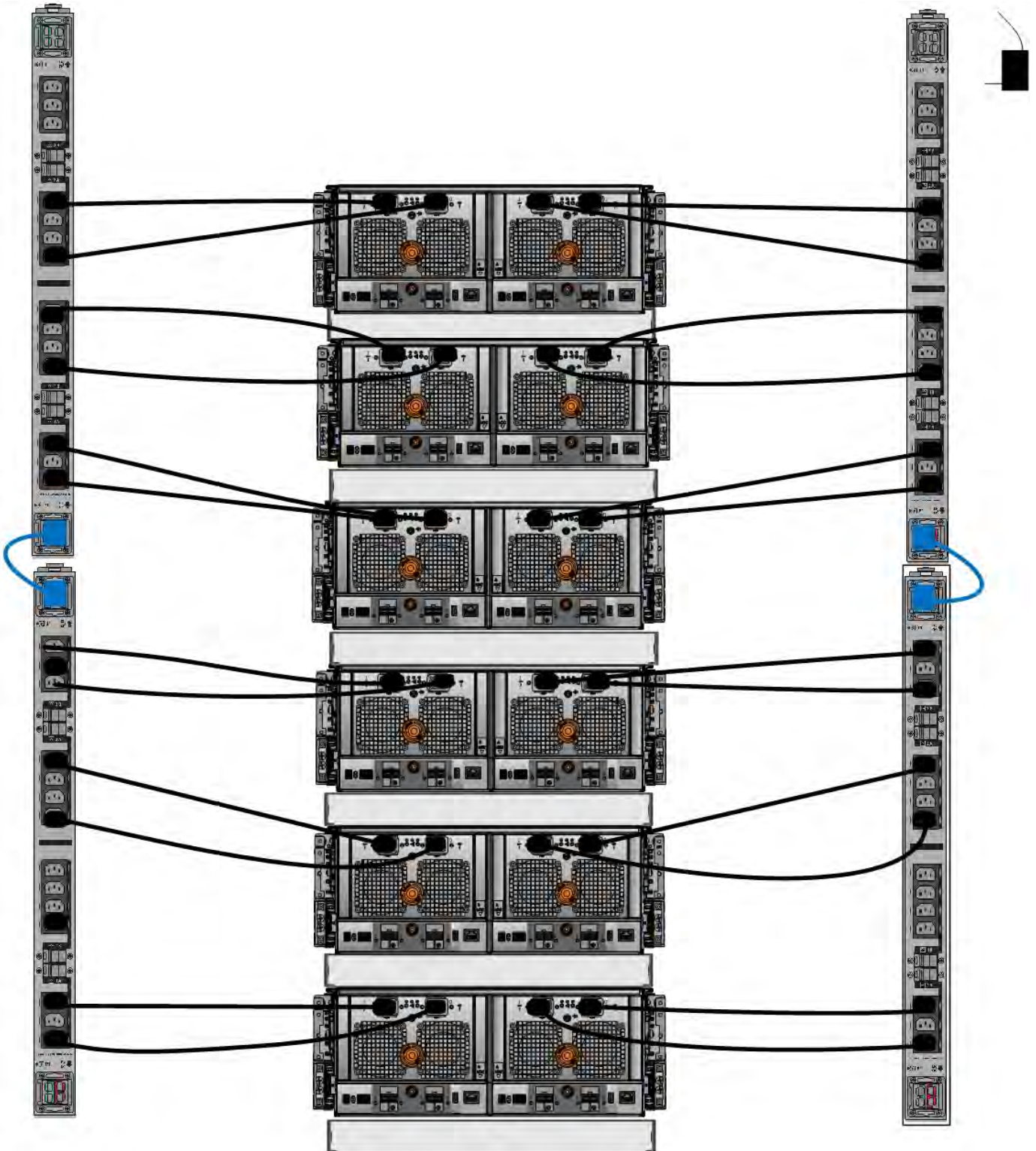


Figure 56. 3-phase delta power connections for DS60 expansion shelves (full-racked)



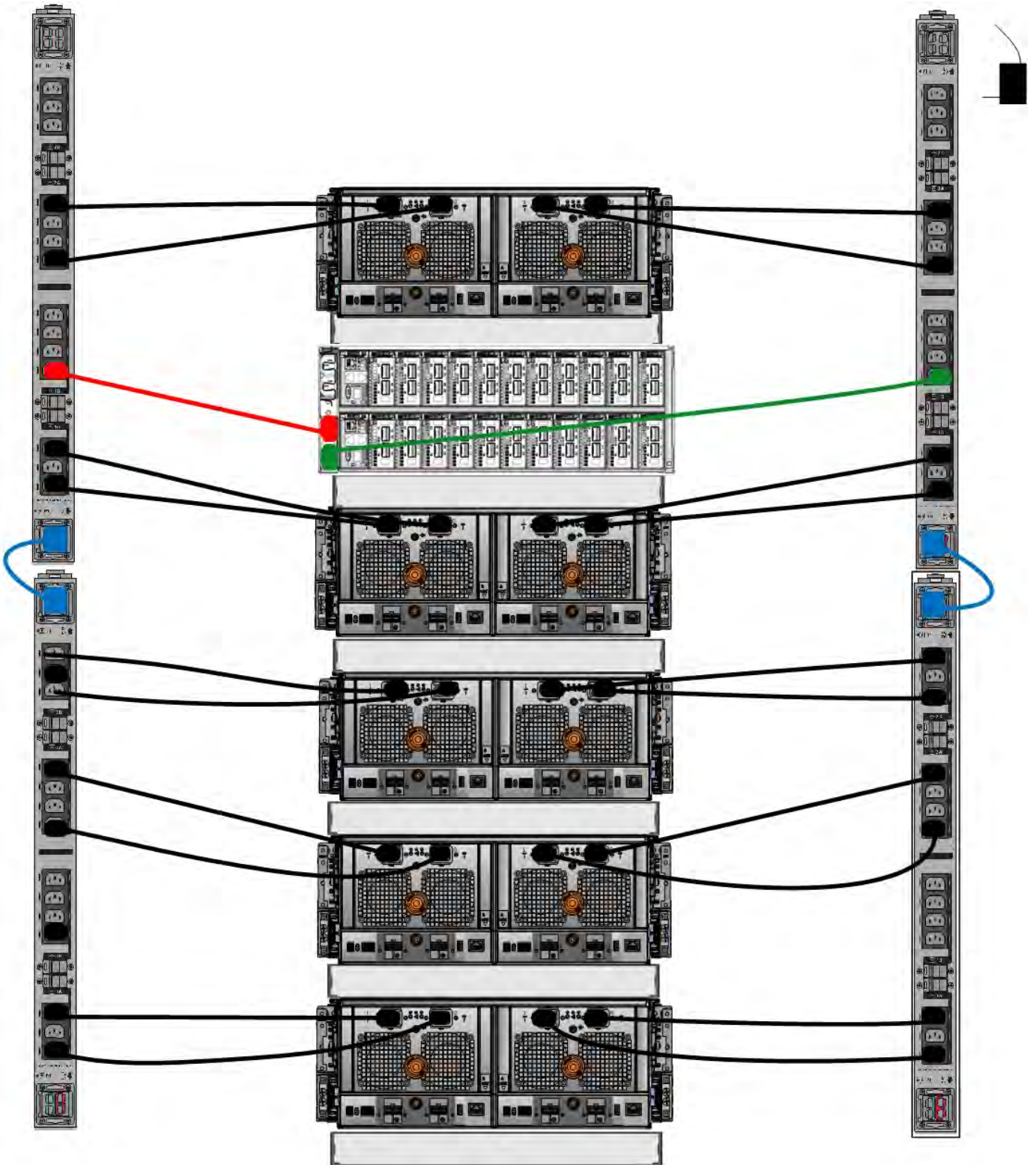


Figure 57. 3-phase delta power connections for DD4200, DD4500, and DD7200 systems

**NOTE:** The next few diagrams show recommended 3-phase wye power connections.

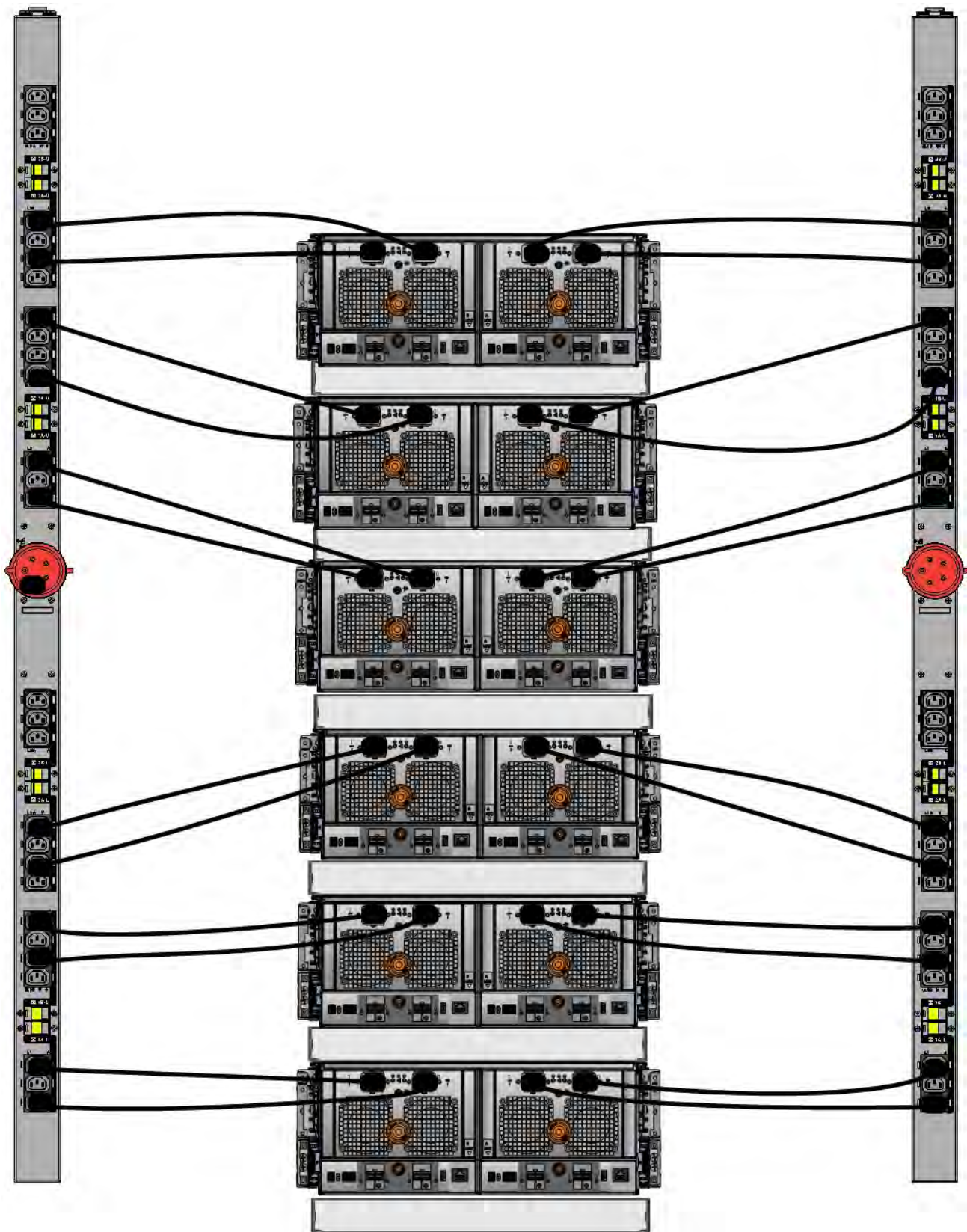


Figure 58. 3-phase wye power connections for DS60 expansion shelves (full-racked)



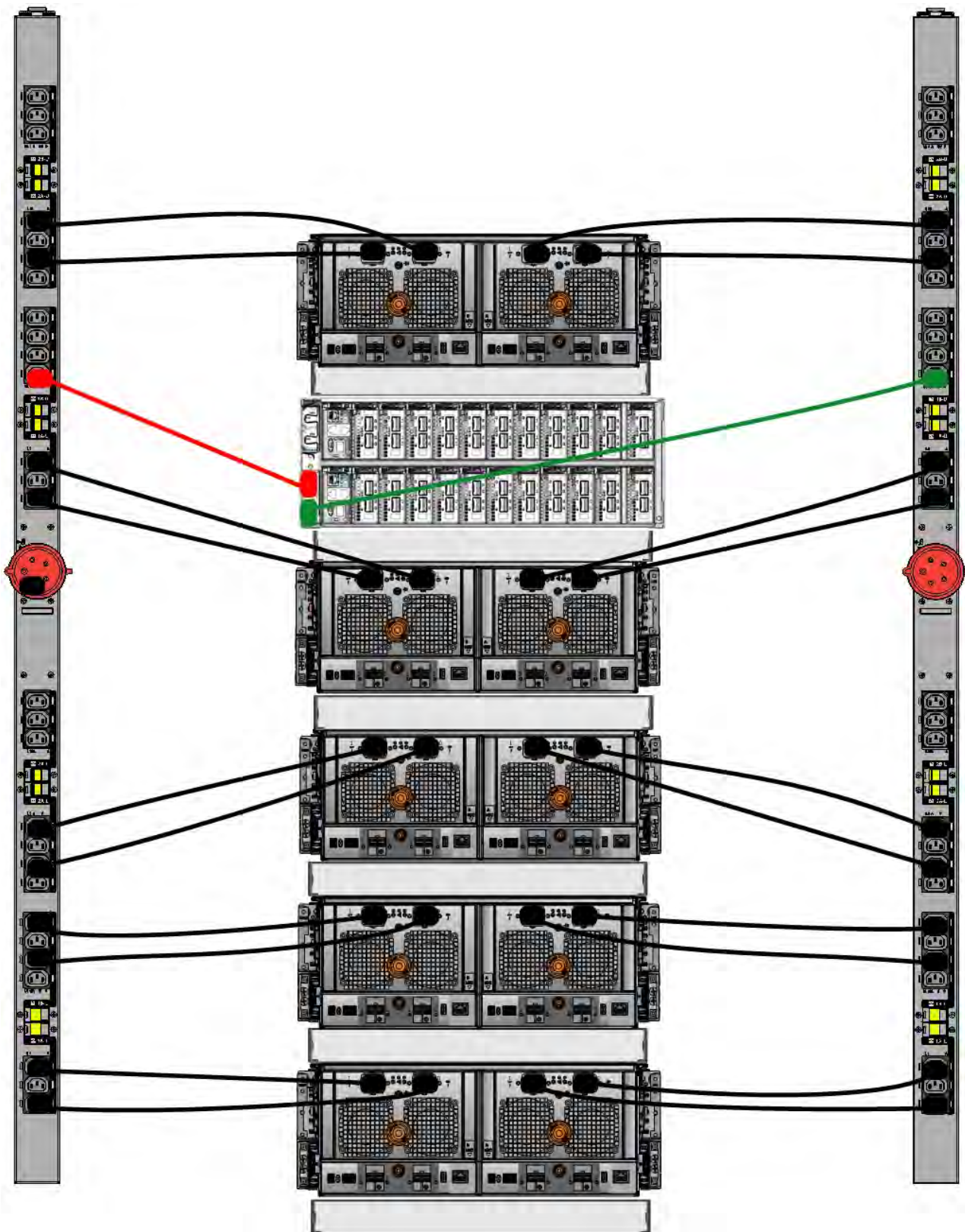


Figure 59. 3-phase wye power connections for DD4200, DD4500, and DD7200 systems

## DS60 and DD4500 cabling

There are a few rules that must be followed when adding a mixture of DS60 and other shelf types to your system.

 **CAUTION:** If a system does not follow all these rules, it is not a legitimate configuration.

Prerequisites:

- You cannot exceed the maximum amount of usable capacity displayed in cabling table for each system.
- You cannot exceed the maximum number of shelves displayed in cabling table for each system.
- You cannot connect more than two DS60 shelves in a single set.

**Table 33. Minimum and maximum configurations**


System	Appliance maximum	Minimum appliance shelf count
DD4500	288 TB	1

Mixing DS60, ES30, and ES20 shelves:


The non-Extended Retention versions of these systems all support four chains.

Extra planning and reconfiguration may be required to add DS60 shelves to system with ES20 shelves, ES30 SATA shelves, or a combination of shelves.

- The ES20 shelves must be on their own set. Minimize the ES20 set count by combining up to four ES20s per set.
- ES30 SATA shelves must also be on their own sets. Minimize the ES30 set count by combining up to five ES30s per set. If required, combine up to seven ES30 SAS shelves per set to minimize the set count.
- A set can contain a maximum of two DS60 shelves and, if required because of other restrictions, add ES30 SAS shelves up to a maximum of five shelves in that set.

 **NOTE:** The configuration rules apply also to Extended Retention systems.

The following figures show cabling for base systems and systems with the Extended Retention software.

 **NOTE:** It is recommended that the DS60 shelf with the greater number of drives should always be placed in the bottom position.

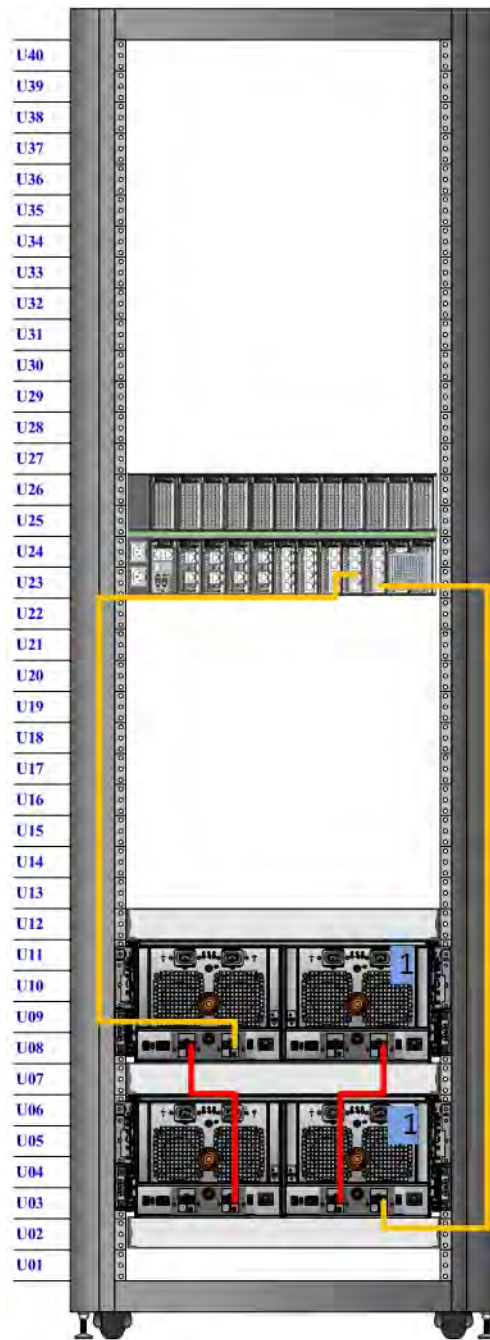


Figure 60. Recommended cabling for DD4500 (3TB drives)



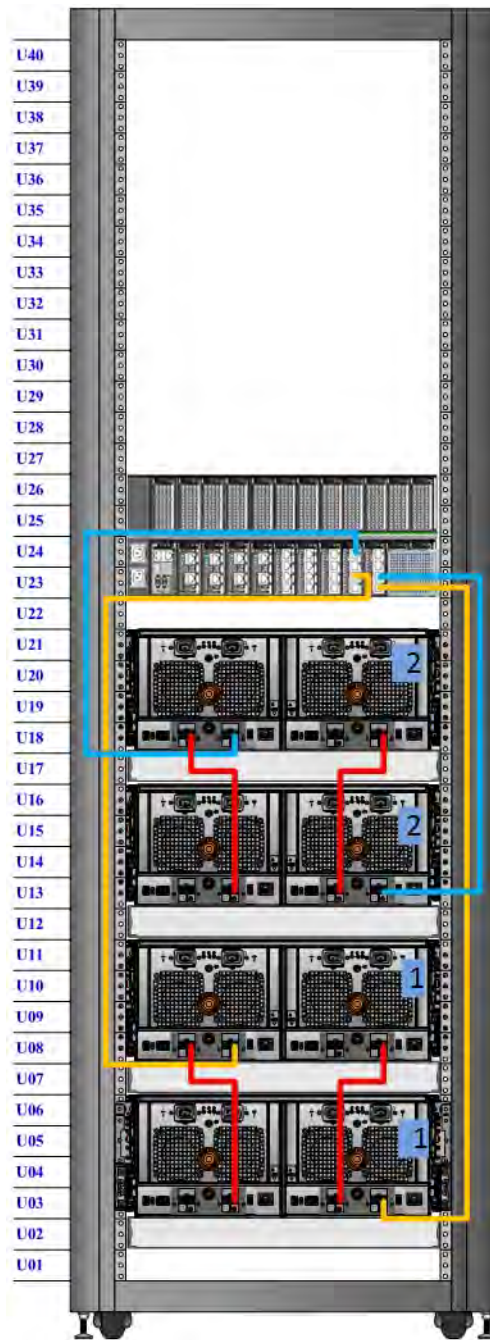


Figure 61. Recommended cabling for DD4500 (3TB drives) with Extended Retention software

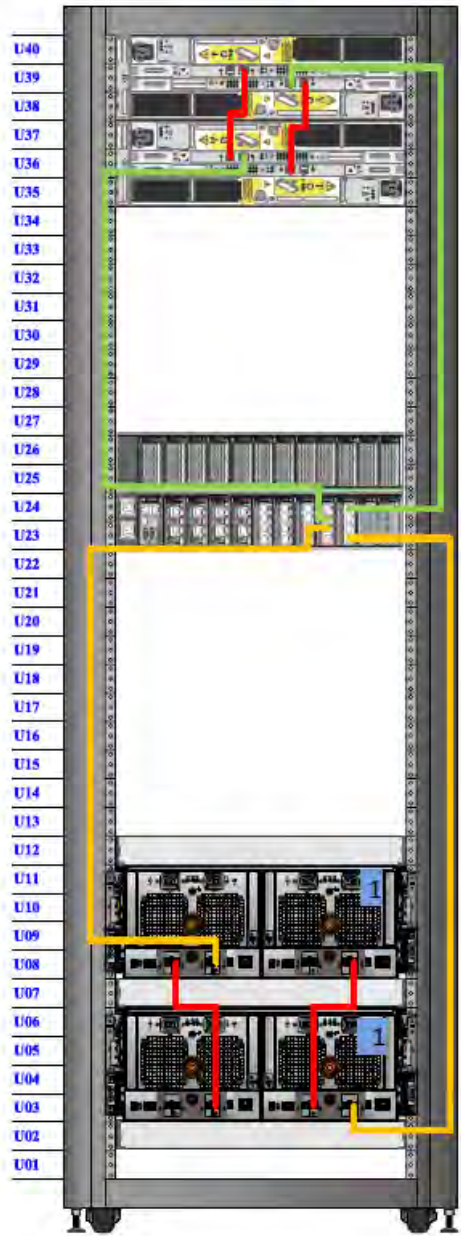


Figure 62. Recommended cabling for DD4500 with DD Cloud Tier

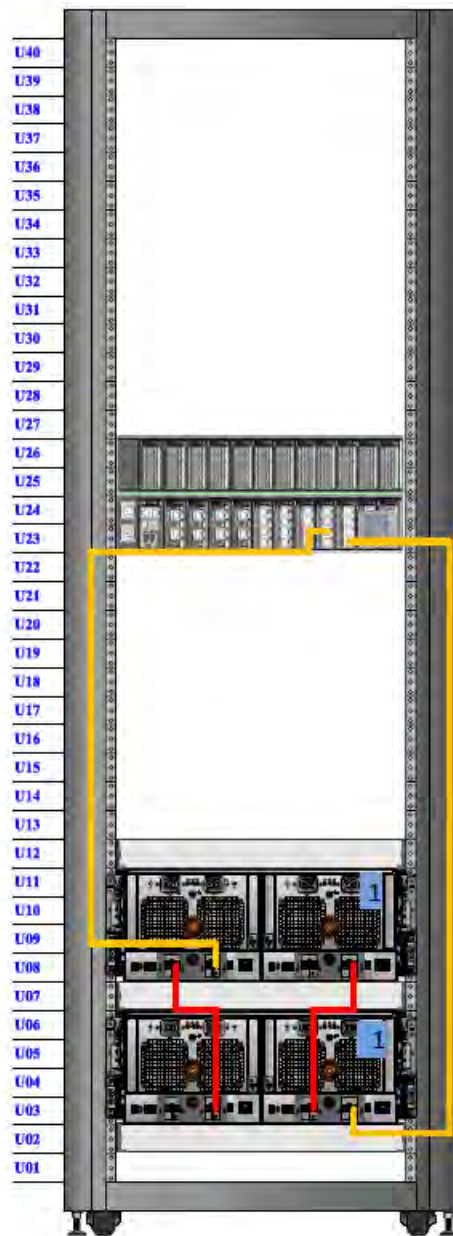


Figure 63. Recommended cabling for DD4500 (4TB drives)

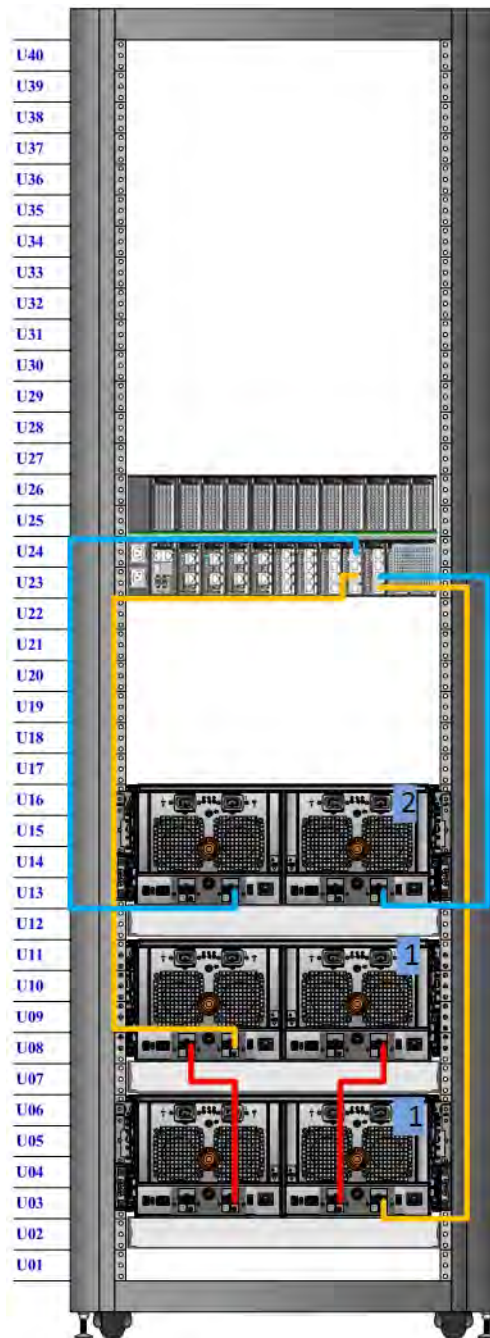


Figure 64. Recommended cabling for DD4500 (4TB drives) with Extended Retention software

# DD6300

This chapter contains the following topics:

## Topics:

- [DD6300 system features](#)
- [DD6300 system specifications](#)
- [DD6300 storage capacity](#)
- [DD6300 front panel](#)
- [Back panel](#)
- [I/O modules](#)
- [Internal system components](#)
- [DD6300 and ES30 shelf guidelines](#)
- [DD6300 and DS60 shelf guidelines](#)

## DD6300 system features

**Table 34. DD6300 system features**

Feature		Base configuration	Expanded configuration
Rack height		2U	2U
Processor		E5-2620 V3	E5-2620 V3
Kernel		3.2.x	3.2.x
NVRAM		NVRAM 8g Model 3	NVRAM 8g Model 3
Memory		6 x 8 GB DIMM (48 GB)	12 x 8 GB DIMM (96 GB)
Internal drives	HDDs in 3.5" bays	7/ 7+5	12
	SSDs in 3.5" bays	0	0
	SSDs in 2.5" bays	1	2
I/O module slots	SAS I/O modules (Quad Port 6 Gbps SAS)	<ul style="list-style-type: none"> <li>• 0 for internal storage only</li> <li>• 1 with external storage</li> </ul>	<ul style="list-style-type: none"> <li>• 0 for internal storage only</li> <li>• 1 with external storage</li> </ul>
	Network and FC I/O modules	Four replaceable I/O module slots. Not hot-swappable.	Four replaceable I/O module slots. Not hot-swappable.
Supported capacity		76 TB (28 TB internal + 48 TB external)	180 TB (36 TB internal + 144 TB external)
High availability support		No	No
HA private interconnect		N/A	N/A
External SSD shelf		N/A	N/A
SAS string depth (max)	ES30	1	4
	DS60	0	1
Stream count		270 writes, 75 reads	270 writes, 75 reads

# DD6300 system specifications

**Table 35. DD6300 system specifications**

Average power consumption 25 C	Heat dissipation (operating maximum)	Weight <sup>a</sup>	Width	Depth	Height
530W	1.69 x 10 <sup>6</sup> J/hr (1604 Btu/hr) maximum	80 lbs (36.29 kg)	17.50 in (44.45 cm)	30.5 in (77.5 cm)	3.40 in (8.64 cm)

a. The weight does not include mounting rails. Allow 2.3-4.5 kg (5-10 lb) for a rail set.

**Table 36. System operating environment**

Requirement	Description
Ambient temperature	10°C - 35°C; derate 1.1°C per 1,000 ft (304 m)
Relative humidity (extremes)	20–80% noncondensing
Elevation	0 - 7,500ft (0 - 2,268m)
Operating acoustic noise	L <sub>wad</sub> sound power, 7.5 Bels

## DD6300 storage capacity

The following table provides storage capacity information for the DD6300 system.

**Table 37. DD6300 storage capacity**

Memory	Internal disks	Internal storage (raw)	External storage (raw)	Usable data storage space (TB/TiB/GB/GiB) <sup>a</sup>			
48 GB (Factory base)	<ul style="list-style-type: none"> <li>Front: 7 x 4 TB</li> <li>Rear: 1 x 800 GB SSD</li> </ul>	28 TB	60 TB	<ul style="list-style-type: none"> <li>Internal: 14 TB</li> <li>External: 48 TB</li> </ul>	<ul style="list-style-type: none"> <li>Internal: 12.74 TiB</li> <li>External: 43.68 TiB</li> </ul>	<ul style="list-style-type: none"> <li>Internal: 14,000 GB</li> <li>External: 48,000 GB</li> </ul>	<ul style="list-style-type: none"> <li>Internal: 13,039 GiB</li> <li>External: 44,704 GiB</li> </ul>
48 GB (Factory upgrade)	<ul style="list-style-type: none"> <li>12 x 4 TB HDD</li> <li>Rear: 1 x 800 GB SSD</li> </ul>	48 TB	60 TB	<ul style="list-style-type: none"> <li>Internal: 34 TB</li> <li>External: 48 TB</li> </ul>	<ul style="list-style-type: none"> <li>Internal: 30.94 TiB</li> <li>External: 43.68 TiB</li> </ul>	<ul style="list-style-type: none"> <li>Internal: 34,000 GB</li> <li>External: 48,000 GB</li> </ul>	<ul style="list-style-type: none"> <li>Internal: 31,665 GiB</li> <li>External: 44,704 GiB</li> </ul>
48 GB (Field Upgrade)	<ul style="list-style-type: none"> <li>(7 + 5) x 4 TB HDD</li> <li>Rear: 1 x 800 GB SSD</li> </ul>	48 TB	60 TB	<ul style="list-style-type: none"> <li>Internal: 22 TB</li> <li>External: 48 TB</li> </ul>	<ul style="list-style-type: none"> <li>Internal: 20.02 TiB</li> <li>External: 43.68 TiB</li> </ul>	<ul style="list-style-type: none"> <li>Internal: 22,000 GB</li> <li>External: 48,000 GB</li> </ul>	<ul style="list-style-type: none"> <li>Internal: 20,489 GiB</li> <li>External: 44,704 GiB</li> </ul>
96 GB (Expanded)	<ul style="list-style-type: none"> <li>Front: 12 x 4 TB HDDs</li> <li>Rear: 2 x 800 GB SSD</li> </ul>	48 TB	180 TB	<ul style="list-style-type: none"> <li>Internal: 34 TB</li> <li>External: 144 TB</li> </ul>	<ul style="list-style-type: none"> <li>Internal: 30.94 TiB</li> <li>External: 131 TiB</li> </ul>	<ul style="list-style-type: none"> <li>Internal: 34,000 GB</li> <li>External: 144,000 GB</li> </ul>	<ul style="list-style-type: none"> <li>Internal: 31,665 GiB</li> <li>External: 134,110 GiB</li> </ul>
96 GB (Field upgrade)	<ul style="list-style-type: none"> <li>Front: (7 + 5) x 4 TB HDDs</li> </ul>	48 TB	180 TB	<ul style="list-style-type: none"> <li>Internal: 22 TB</li> <li>External: 144 TB</li> </ul>	<ul style="list-style-type: none"> <li>Internal: 20.02 TiB</li> <li>External: 131 TiB</li> </ul>	<ul style="list-style-type: none"> <li>Internal: 22,000 GB</li> <li>External: 144,000 GB</li> </ul>	<ul style="list-style-type: none"> <li>Internal: 20,489 GiB</li> <li>External: 134,110 GiB</li> </ul>

**Table 37. DD6300 storage capacity (continued)**

Memory	Internal disks	Internal storage (raw)	External storage (raw)	Usable data storage space (TB/TiB/GB/GiB) <sup>a</sup>			
from 48 GB)	<ul style="list-style-type: none"> <li>Rear: 2 x 800 GB SSD</li> </ul>						

a. The capacity differs depending on the size of the external storage shelves used. This data based on ES30 shelves.

## DD6300 front panel

DD6300 All-in-One (AIO) systems have one of the following front panel drive configurations to host the DD OS boot drives, and provide storage for customer data:

**i** **NOTE:** Upgrading a base configuration to an expanded configuration provides less capacity than a factory-built expanded configuration.

**Table 38. DD6300 AIO capacity**

Configuration	Installed drives	Usable internal capacity
DD6300 base configuration	Seven 4 TB HDDs	14 TB
DD6300 expanded configuration (factory)	Twelve 4 TB HDDs	34 TB
DD6300 expanded configuration (upgrade)	Seven 4 TB HDDs + Five 4 TB HDDs	22 TB

**Table 39. DD6300 AIO configuration**

Slot 0: HDD 1	Slot 1: HDD 2	Slot 2: HDD 3	Slot 3: HDD 4
Slot 4: HDD 5	Slot 5: HDD 6	Slot 6: HDD 7	Slot 7: Filler
Slot 8: Filler	Slot 9: Filler	Slot 10: Filler	Slot 11: Filler

**Table 40. DD6300 AIO expanded configuration**

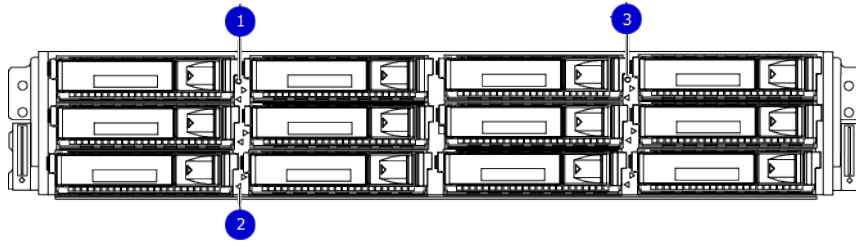
Slot 0: HDD 1	Slot 1: HDD 2	Slot 2: HDD 3	Slot 3: HDD 4
Slot 4: HDD 5	Slot 5: HDD 6	Slot 6: HDD 7	Slot 7: HDD 8
Slot 8: HDD 9	Slot 9: HDD 10	Slot 10: HDD 11	Slot 11: HDD 12

## Front LED indicators

The front of the system contain 12 disk drive status LEDs that are normally blue, and blink when there is activity on the disk. The LEDs are shaped like triangles, and the apex of the triangle points left or right, indicating that disk's status. If the disk drive has a failure, the disk's status LED turns from blue to amber, indicating that a drive must be replaced.

The front also contains two system status LEDs. A blue system power LED is present that is on whenever the system has power. An amber system fault LED is also present that is normally off and lit amber whenever the chassis or any other FRU in the system requires service.





**Figure 65. Front LED indicators**

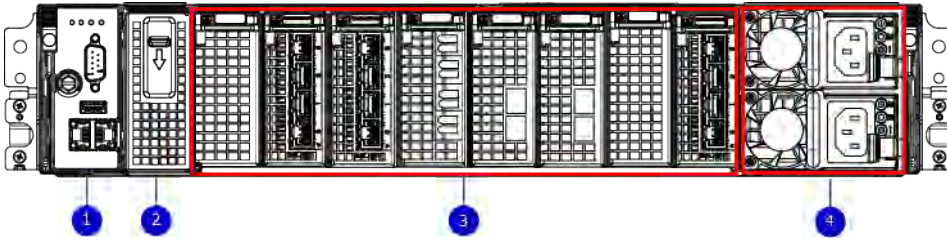
1. System service LED
2. Drive activity/service LED
3. System power LED

**Table 41. Front LEDs**

Name	Color	Purpose
System power LED	Blue	Indication that the system has power.
System service LED	Amber	Normally off; is lit amber whenever the SP or any other FRU (except disk drives) in the system requires service.
Drive activity/Service LED	Blue /Amber	<ul style="list-style-type: none"> <li>• Lit blue when the drive is powered.</li> <li>• Blinks blue during drive activity.</li> <li>• Lit solid amber when a disk needs service.</li> </ul>

# Back panel

The back panel of the chassis contains the following components:



- 1. Management panel
- 2. Two 2.5" SSD slots labeled 0 and 1
- 3. I/O module slots
- 4. Power supply modules (PSU 0 is the lower module, and PSU 1 is the upper module)

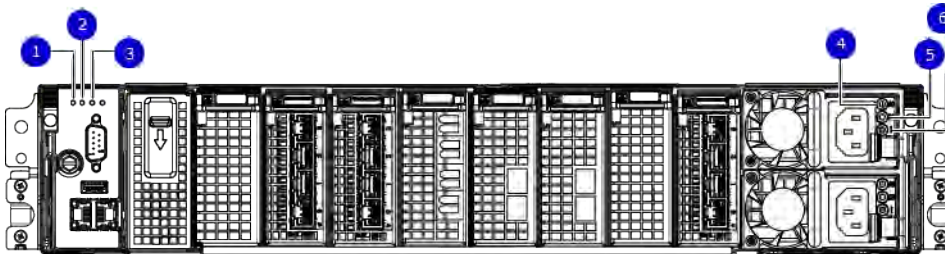
## DD6300 rear SSDs

The D6300 system uses one or two 800 GB SSDs mounted at the rear of the chassis for metadata caching:

**Table 42. DD6300 rear SSDs**

Configuration	Number of SSDs	SSD location
DD6300	1	SSD slot 0
DD6300 expanded	2	SSD slots 0 and 1
<p><b>NOTE:</b> SSDs are not RAID-protected.</p>		

## Rear LED indicators



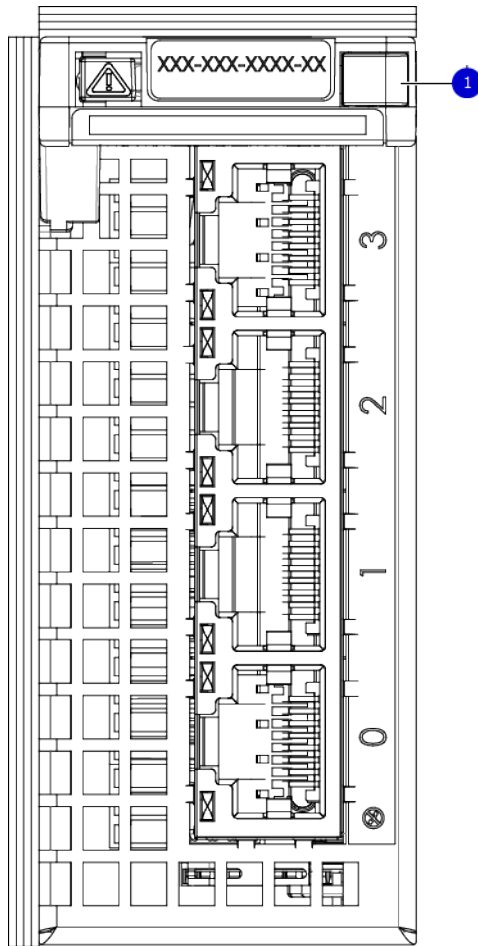
**Figure 66. Rear LED indicators**

- 1. Do not remove LED
- 2. SP service LED
- 3. System power LED
- 4. AC power good LED
- 5. DC power good LED
- 6. Power supply fault LED

Name of LED	Location	Color	Definition
"Do not remove" LED	Upper left-most part of rear chassis	White	This LED is lit during system BIOS and BMC firmware updates and indicates that the SP should not be removed from the chassis, nor should system power be removed.

Name of LED	Location	Color	Definition
SP service LED	To the right of "Do not remove" LED	Amber	<ul style="list-style-type: none"> <li>● Solid amber - SP or a FRU inside the SP requires service</li> <li>● Blinking amber - blink rate reflects one of the following is booting <ul style="list-style-type: none"> <li>○ BIOS - 1/4 Hz</li> <li>○ POST - 1 Hz</li> <li>○ OS - 4 Hz</li> </ul> </li> </ul>
Drive Power/Activity LED <sup>a</sup>	Left LED on the SSD	Blue	Lit blue when the drive is powered. Blinks during drive activity.
Drive Fault LED <sup>a</sup>	Right LED on the SSD	Amber	Lit solid amber when a drive needs service.
System power LED	Right-most LED on the management panel	Blue	SP has good, stable power
PSU FRU LED - AC Good	Top LED on power supply	Green	AC input is as expected
PSU FRU LED - DC Good	Middle LED on power supply	Green	DC output is as expected
PSU FRU LED - Attention	Bottom LED on power supply	Amber	PSU has encountered a fault condition

a. The SSD is only present on DD6300 systems.



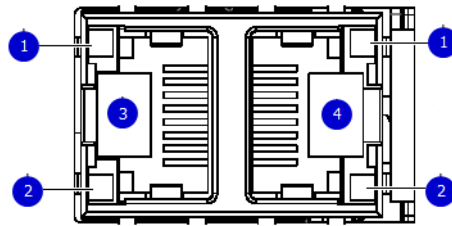
**Figure 67. I/O module Power/Service LED location**

1. I/O module power/service LED

**Table 43. I/O LEDs**

Name of LED	Location	Color	Definition
I/O module FRU LED - I/O module Power/Service LED location on page 115	Ejector handle of I/O modules	Green/Amber	<ul style="list-style-type: none"> <li>Green - I/O module has power and is functioning normally</li> <li>Amber - I/O module has encountered a fault condition and requires service</li> </ul>
I/O port status LED (SAS, Fibre Channel, and optical networking I/O modules only)	One LED per I/O module port	Blue	Lit when port is enabled. May flash if SW "marks" the port. <sup>a</sup>

a. For RJ45 networking ports, the standard green link and amber activity LEDs are used.



**Figure 68. Onboard network port LEDs**

1. Network port link LED
2. Network port activity LED
3. Dedicated IPMI port BMC0A
4. Management interface EthMa

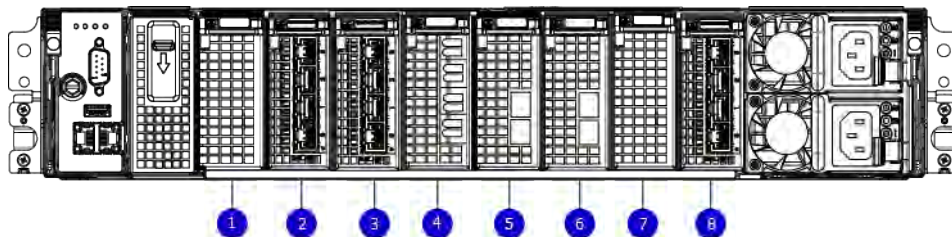
**Table 44. Onboard network port LEDs**

Name of LED	Location	Color	Definition
Onboard network port LED - Link LED <a href="#">Onboard network port LEDs</a> on page 116	Top LED on network port	Green	<ul style="list-style-type: none"> <li>• Lit when there is a link at 1000BaseT and 100BaseT speeds</li> <li>• Off when the link speed is 10BaseT or there is no link</li> </ul>
Onboard network port LED - Activity LED	Bottom LED on network port	Amber	Blinks when there is traffic on the port

## I/O modules

### I/O module slot numbering

The eight I/O module slots are enumerated as Slot 0 (on the left when viewed from the rear) through Slot 7. Ports on an I/O module are enumerated as 0 through 3, with 0 being on the bottom.



**Figure 69. I/O module slot numbering**

1. Slot 0
2. Slot 1
3. Slot 2
4. Slot 3
5. Slot 4
6. Slot 5
7. Slot 6
8. Slot 7

I/O modules are only supported in fixed configurations. The fixed configurations define the exact slots into which the I/O modules may be inserted. The processors directly drive the eight I/O module slots, meaning all slots are full performance.

The non-optional SAS, NVRAM, and 10GBaseT I/O modules are allocated to fixed slots. The optional Host Interface I/O modules are used for front end networking and Fibre Channel connections. The quantity and type of these I/O modules is customizable, and there are many valid configurations.

## DD6300 slot map

Slot 0, Slot 1, Slot 2 (except when it is marked "Reserved") are populated with the required I/O modules and are not optional. I/O module slots 3-7 contain optional Host Interface I/O modules and can contain specific I/O modules or no I/O modules at all.

**Table 45. DD6300 I/O slot module mapping**

Tier	Slot 0	Slot 1	Slot 2	Slot 3	Slot 4	Slot 5	Slot 6	Slot 7
AIO Expanded	NVRAM 8g Model 3	Quad Port 10 GBase-T	Reserved	(Optional) Quad Port 10GbE SR, Quad Port 10 GBase-T, or Dual Port 16 Gbps Fibre Channel	(Optional) Quad Port 10GbE SR, Quad Port 10 GBase-T, or Dual Port 16 Gbps Fibre Channel	(Optional) Quad Port 10GbE SR, Quad Port 10 GBase-T, or Dual Port 16 Gbps Fibre Channel	(Optional) Quad Port 10GbE SR, Quad Port 10 GBase-T, or Dual Port 16 Gbps Fibre Channel	(Optional) Quad Port 6 Gbps SAS <sup>a</sup>
AIO	NVRAM 8g Model 3	Quad Port 10 GBase-T	Reserved	Quad Port 10GbE SR, Quad Port 10 GBase-T, or Dual Port 16 Gbps Fibre Channel	Quad Port 10GbE SR, Quad Port 10 GBase-T, or Dual Port 16 Gbps Fibre Channel	Quad Port 10GbE SR, Quad Port 10 GBase-T, or Dual Port 16 Gbps Fibre Channel	Quad Port 10GbE SR, Quad Port 10 GBase-T, or Dual Port 16 Gbps Fibre Channel	Quad Port 6 Gbps SAS <sup>a</sup>

a. Optional in configurations, but required with one or more external storage shelves.

## I/O module population rules

The system chassis has eight slots for I/O modules. Slots 0, 1, 2, and 7 are reserved. Slots 3, 4, 5, and 6 support host interface I/O modules. The maximum supported number of any type of host interface I/O module is four.

**NOTE:** A maximum of three Quad Port 10 GBase-T I/O modules are supported in slots 3-6 because of the mandatory Quad Port 10 GBase-T I/O module in slot 1.

The following table assigns rules for populating the I/O modules.

**Table 46. I/O module slot population rules**

Step	I/O module name	Slots	Notes
Step 1: Populate mandatory I/O modules	NVRAM 8g Model 3	0	Mandatory for all configurations
	Quad Port 10 GBase-T	1	Mandatory for all configurations
	Quad Port 6 Gbps SAS	2	Reserved for DD6300 expanded configuration.
	Quad Port 6 Gbps SAS	7	Reserved for DD6300 base configuration.
Step 2: Populate all Quad Port 10GbE SR I/O modules	Quad Port 10GbE SR	3, 4, 5, 6	Populate starting from the lowest available slot number.
Step 3: Populate all Quad Port 10 GBase-T I/O modules	Quad Port 10 GBase-T	3, 4, 5, 6	Populate starting from the lowest available slot number. With Quad Port 10 GBase-T



**Table 46. I/O module slot population rules (continued)**

<b>Step</b>	<b>I/O module name</b>	<b>Slots</b>	<b>Notes</b>
			in slot 1, max number of Quad Port 10 GBase-T I/O modules are limited to 4.
Step 4: Populate all Dual Port 16 Gbps Fibre Channel I/O modules	Dual Port 16 Gbps Fibre Channel	6, 5, 4, 3	Populate starting from the highest available slot number.

# Internal system components

The following figure shows the layout of the CPUs and DIMMs inside the chassis. The front of the system is at the top of the figure.

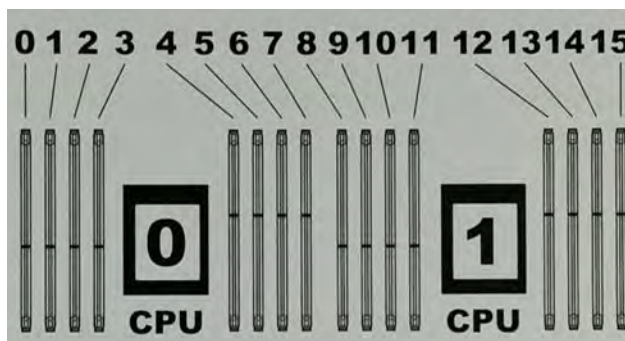


Figure 70. CPU and memory locations

## DIMMs overview

Dual in-line memory modules (DIMM) come in various sizes, which must be configured in a certain way. This topic can help you select the correct configuration when servicing DIMMs.

The storage processor contains two Intel processors each with an integrated memory controller that supports four channels of memory. The storage processor allows two DIMM slots per channel, so the storage processor supports a total of 16 DIMM slots.

## DD6300 memory DIMM configuration

Table 47. DD6300 memory DIMM configuration

Tier	Total Memory	Memory DIMM Configuration
AIO Expanded	96 GB	12 x 8 GB
AIO	48 GB	6 x 8 GB

To ensure maximum memory performance, there are memory DIMM population rules for best memory loading and interleaving. [Memory locations - CPU 0](#) on page 119 and [Memory locations - CPU 1](#) on page 119 specify the DIMM location rules for various memory configurations:

Table 48. Memory locations - CPU 0

		Channel A		Channel B		Channel D		Channel C	
Tier	Total Memory	0	1	2	3	4	5	6	7
AIO Expanded	96 GB	8 GB	N/A	8 GB	N/A	8 GB	8 GB	8 GB	8 GB
AIO	48 GB	N/A	N/A	8 GB	N/A	N/A	8 GB	N/A	8 GB

Table 49. Memory locations - CPU 1

		Channel A		Channel B		Channel D		Channel C	
Tier	Total Memory	8	9	10	11	12	13	14	15
AIO Expanded	96 GB	8 GB	8 GB	8 GB	8 GB	N/A	8 GB	N/A	8 GB
AIO	48 GB	8 GB	N/A	8 GB	N/A	N/A	8 GB	N/A	N/A

# DD6300 and ES30 shelf guidelines

The system rediscovers newly configured shelves after it restarts. You can power off the system and recable shelves to any other position in a set, or to another set. To take advantage of this flexibility, you need to follow these rules before making any cabling changes:

- Do not exceed the maximum shelf configuration values for your system as listed in the following table below.
- Use the Installation and Setup Guide for your system to minimize the chance of a cabling mistake.
- A system cannot exceed its maximum raw external shelf capacity, regardless of added shelf capacity.
- ES30 SATA shelves must be on their own chain.

**Table 50. DD6300 and ES30 shelf configuration**

DD system	Memory required (GB)	SAS cards/port per card	ES30 support (TB)	Max shelves per set	Max number of sets	Max external capacity available (TB) <sup>1</sup>	Max RAW external capacity (TB) <sup>2</sup>
DD6300	48	1x4 (Optional)	SAS 30, 45, 60	1	1	48	60
DD6300 w/ Expanded Capacity <sup>3</sup>	96	1x4 (Optional)	SAS 30, 45, 60	5	1	144	180

1. This figure only counts drives that have user data in the shelves.

2. The raw capacity of an ES30 is 125% of the available capacity.

3. DDOS 6.0 and FS15 SSD shelf configuration

## Types of cabinets and power connections

The ES30 chassis is installed in two types of racks: 40U-C (existing racks) and the 40U-P (newer racks). The racks use one phase or 3-phase power connections.

### 3-Phase power connections for 40U-P (current racks)

Some environments use 3-phase power for 40U-P racks that are used for several systems. In those situations, it is desirable to balance the current draw across all three phases. The recommended 3-phase power cabling attempts to do that, but an optimal configuration depends on the specific installation.

## Cabling shelves

### **i** NOTE:

- Before cabling the shelves, physically install all shelves in the racks. Refer to the rail kit installation instructions included with the ES30 shelf for rack mounting.
- The documentation refers to two SAS HBAs. If only one HBA is allowed in a system, then use another port as defined later for that specific system.
- On an HA system, add cables from the second node to open ports at the end of the sets. The ports on the second node must connect to the same sets as the corresponding ports on the first node.

Ports on the system's SAS HBA cards connect directly to a shelf controller's host port. For redundancy, you need to create dual paths by using a port on one SAS HBA card to connect to one shelf controller in each shelf set, and a port on another SAS HBA card to connect to another shelf controller in the same shelf set. With dual paths, if one SAS HBA card fails, the shelf is still operational. However, in the unlikely event any single shelf becomes completely disconnected from power or SAS cables and becomes disconnected from a previously operational shelf, the file system goes down and the shelf is not operational. This is considered a double failure.

There are two kinds of configurations: one shelf in a set or multiple shelves in a set.

## DD6300, DD6800, and DD9300 shelf configurations

There are a few rules that must be followed when adding a mixture of DS60 and other shelf types to your system.

**CAUTION:** If a system does not follow ALL of these rules it is not a legitimate configuration.

Prerequisites:

- You cannot exceed the maximum amount of raw capacity displayed in the cabling table for each system.
- You cannot exceed the maximum number of shelves displayed in the cabling table for each system.
- There are no specific placement or cabling requirements for SSD shelves, or the metadata shelves for Cloud Tier configurations. These shelves can be installed and cabled the same way as standard ES30 shelves.

**Table 51. Minimum and maximum configurations**

System	Appliance	Minimum appliance shelf count*	Max appliance shelf count
	48 TB usable	0	1
w/ Expansion	144 TB usable	1	5
	144 TB usable	2	28
w/ Expansion	288 TB usable	2	28
w/ High Availability (HA)	288 TB usable	2	28
w/ Extended Retention (ER)	576 TB usable	2	28
w/ Cloud Tier	288 TB usable (96 TB for Cloud Tier)	2	28
w/ HA and Cloud Tier	288 TB usable (96 TB for Cloud Tier)	2	28
	384 TB usable	3	28
w/ Expansion	720 TB usable	3	28
w/ HA	720 TB usable	3	28
w/ ER	1440 TB usable	7	28
w/ Cloud Tier	720 TB usable (192 TB for Cloud Tier)	7	28
w/ HA and Cloud Tier	720 TB usable (192 TB for Cloud Tier)	7	28

\* The minimum appliance shelf count does not include shelves for Cloud Tier.

## DD6300 and DS60 shelf guidelines

The system rediscovers newly configured shelves after it restarts. You can power off the system and recable shelves to any other position in a set, or to another set. To take advantage of this flexibility, you need to follow these rules before making any cabling changes:

- Do not exceed the maximum shelf configuration values for your system as listed in the following table.
- For redundancy, the two connections from a system to a set of shelves must use ports on different SAS I/O modules.
- Use the Installation and Setup Guide for your system to minimize the chance of a cabling mistake.
- A system cannot exceed its maximum raw external shelf capacity, regardless of added shelf capacity.
- ES30 SATA shelves must be on their own chain.
- If ES30 SAS shelves are on the same chain as a DS60, the maximum number of shelves on that chain is 5.

**Table 52. DD6300 and DS60 shelf configuration**

DD system	Memory required (GB)	SAS cards/port per card	DS60 support (TB)	Max shelves per set	Max number of sets	Max external capacity available (TB) <sup>1</sup>	Max RAW external capacity (TB)
DD6300 <sup>2</sup>	48 <sup>3</sup>	1x4 <sup>4</sup>	N/A	0	0	48	60
DD6300 w/ Expanded Capacity <sup>2</sup>	96	1x4 <sup>4</sup>	SAS 45, 60 <sup>5</sup>	1	1	144	180

**NOTE:** An entry of 45 corresponds to DS60-3 models and an entry of 60 corresponds to DS60-4 models.

1. This column only counts drives that have user data in the shelves. For example, a DS60 4-240 has 192TB.
2. Only available with DD OS 6.x and greater.
3. Base configuration does not support DS60 additional capacity; must have memory configuration of 96GB.
4. One SAS card is optional and must be ordered with external SAS shelf order. Dual paths from this single SAS card to external shelves are required.
5. The DS60 will have a maximum of 45 4Tb drives.

## shelf configurations

There are a few rules that must be followed when adding a mixture of DS60 and other shelf types to your system.

**CAUTION:** If a system does not follow all these rules, it is not a legitimate configuration.

Prerequisites:

- You cannot exceed the maximum amount of raw capacity displayed in cabling table for each system.
- You cannot exceed the maximum number of shelves displayed in cabling table for each system.
- You cannot connect more than three DS60 shelves in a single set.

**Table 53. Minimum configurations**

System	Appliance maximum	Minimum appliance DS60 shelf count
	144 TB	0
	144 TB	2
w/ High Availability (HA)	288 TB	2 (plus 1 FS15 for SSD cache)
w/ Extended Retention (ER)	576 TB	2
w/ Cloud Tier	384 TB (96 TB for Cloud Tier)	2 (plus 2 ES30s for Cloud Tier)
w/ HA and Cloud Tier	384 TB (96 TB for Cloud Tier)	2 (plus 1 FS15 for SSD cache, and 2 ES30s for Cloud Tier)
	384 TB	3
w/ HA	720 TB	3 (plus 1 FS15 for SSD cache)
w/ ER	1440 TB	3
w/ Cloud Tier	912 TB (192 TB for Cloud Tier)	3 (plus 4 ES30s or 1 DS60 for Cloud Tier)
w/ HA and Cloud Tier	912 TB (192 TB for Cloud Tier)	4 (plus 1 FS15 for SSD cache, and 4 ES30s or 1 DS60 for Cloud Tier)

1. DS60 will only be partially filled.

- A Cloud Tier system shares the ERSO cabling configuration; however, Cloud Tier has a lower maximum.
- It is recommended that the shelf with the greater number of drives should always be placed in the bottom position.
- only supports one DS60.
- only has one SAS SLIC and all DS60 connections are made to that single SAS SLIC.

- only has one SAS SLIC and all DS60 connections are made to that single SAS SLIC.



# DD6800

This chapter contains the following topics:

## Topics:

- [DD6800 system features](#)
- [DD6800 system specifications](#)
- [DD6800 storage capacity](#)
- [DD6800 front panel](#)
- [Back panel](#)
- [I/O modules](#)
- [Internal system components](#)
- [DD6800 and ES30 shelf guidelines](#)
- [DD6800 and DS60 shelf guidelines](#)

## DD6800 system features

**Table 54. DD6800 system features**

Feature		Base configuration	Expanded configuration
Rack height		2U	2U
Processor		E5-2630 V3	E5-2630 V3
Kernel		3.2.x	3.2.x
NVRAM		NVRAM 8g Model 3	NVRAM 8g Model 3
Memory		8 x 8 GB DIMM + 8 x 16 GB DIMM (192 GB)	8 x 8 GB DIMM + 8 x 16 GB DIMM (192 GB)
Internal drives	HDDs in 3.5" bays	7/ 7+5	12
	SSDs in 3.5" bays	0	0
	SSDs in 2.5" bays	1	2
I/O module slots	SAS I/O modules (Quad Port 6 Gbps SAS)	2	2
	Network and FC I/O modules	Four replaceable I/O module slots. Not hot-swappable.	Four replaceable I/O module slots. Not hot-swappable.
Supported capacity	Non-extended retention	144 TB	288 TB
	DD Cloud Tier	N/A	576 TB <sup>a</sup>
	Extended retention	N/A	288 TB <sup>b</sup>
High availability support		Yes	Yes
HA private interconnect		(2) 10GBase-T ports	(2) 10GBase-T ports
External SSD shelf		One SSD shelf for A-P high availability cluster containing two drives.	One SSD shelf for A-P high availability cluster containing four drives.
SAS string depth (max)	ES30	1	4

**Table 54. DD6800 system features (continued)**

Feature		Base configuration	Expanded configuration
	DS60	0	1
	ES30 and DS60	5 shelves total	5 shelves total
Stream count		405 writes, 112 reads	405 writes, 112 reads

- a. DD Cloud Tier requires two ES30 shelves fully populated with 4 TB drives to store DD Cloud Tier metadata.
- b. Extended retention not available on HA configurations

## DD6800 system specifications

**Table 55. DD6800 system specifications**

Average power consumption 25 C	Heat dissipation (operating maximum)	Weight <sup>a</sup>	Width	Depth	Height
560W	1.69 x 10 <sup>6</sup> J/hr (1604 Btu/hr) maximum	68 lbs (30.84 kg)	17.50 in (44.45 cm)	30.5 in (77.5 cm)	3.40 in (8.64 cm)

- a. The weight does not include mounting rails. Allow 2.3-4.5 kg (5-10 lb) for a rail set.

**Table 56. System operating environment**

Requirement	Description
Ambient temperature	10°C - 35°C; derate 1.1°C per 1,000 ft (304 m)
Relative humidity (extremes)	20–80% noncondensing
Elevation	0 - 7,500ft (0 - 2,268m)
Operating acoustic noise	L <sub>wad</sub> sound power, 7.5 Bels

## DD6800 storage capacity

The following table provides storage capacity information for the DD6800 system.

**Table 57. DD6800 storage capacity**

Memory	Internal disks (system disks only)	External storage (raw)	Usable data storage space (TB/TiB/GB/GiB) <sup>a</sup>			
192 GB (Base)	<ul style="list-style-type: none"> <li>• 4 x 4 TB HDD</li> <li>• 2 x 800 GB SSD</li> </ul>	180 TB <sup>b</sup>	144 TB	131 TiB	144,000 GB	134,110 GiB
192 GB (Expanded)	<ul style="list-style-type: none"> <li>• 4 x 4 TB HDD</li> <li>• 4 x 800 GB SSD</li> </ul>	<ul style="list-style-type: none"> <li>• Active Tier: 360 TB<sup>b</sup></li> <li>• Archive Tier: 360 TB<sup>c</sup></li> <li>• Cloud Tier: 720 TB in the cloud<sup>d</sup></li> <li>• Cloud Tier metadata: 120 TB</li> </ul>	<ul style="list-style-type: none"> <li>• Active Tier: 288 TB</li> <li>• Archive Tier: 288 TB</li> <li>• Cloud Tier: 576 TB</li> <li>• Cloud Tier metadata: 96 TB</li> </ul>	<ul style="list-style-type: none"> <li>• Active Tier: 261.9 TiB</li> <li>• Archive Tier: 261.9 TiB</li> <li>• Cloud Tier: 523.8 TiB</li> <li>• Cloud Tier metadata: 87.3 TiB</li> </ul>	<ul style="list-style-type: none"> <li>• Active Tier: 288,000 GB</li> <li>• Archive Tier: 288,000 GB</li> <li>• Cloud Tier: 576,000 GB</li> <li>• Cloud Tier metadata: 96,000 GB</li> </ul>	<ul style="list-style-type: none"> <li>• Active Tier: 268,221 GiB</li> <li>• Archive Tier: 268,221 GiB</li> <li>• Cloud Tier: 536,442 GiB</li> <li>• Cloud Tier metadata: 89,407 GiB</li> </ul>

**Table 57. DD6800 storage capacity (continued)**

Memory	Internal disks (system disks only)	External storage (raw)	Usable data storage space (TB/TiB/GB/GiB) <sup>a</sup>			
		local storage				

- a. The capacity differs depending on the size of the external storage shelves used. This data based on ES30 shelves.
- b. HA is supported.
- c. HA is not supported with Extended Retention.
- d. HA is supported in combination with Cloud Tier.

## DD6800 front panel

DD6800 Dataless Head (DLH) systems have one of the following front panel drive configurations to host the DD OS boot drives and provide metadata caching on SSD:

**Table 58. DD6800 DLH SSD requirements**

Configuration	Number of SSDs
DD6800	2
DD6800 expanded	4

**NOTE:** SSDs are not RAID-protected.

**Table 59. DD6800 DLH configuration drive layout**

Slot 0: HDD 1	Slot 1: HDD 2	Slot 2: HDD 3	Slot 3: HDD 4
Slot 4: SSD 1	Slot 5: SSD 2	Slot 6: Filler	Slot 7: Filler
Slot 8: Filler	Slot 9: Filler	Slot 10: Filler	Slot 11: Filler

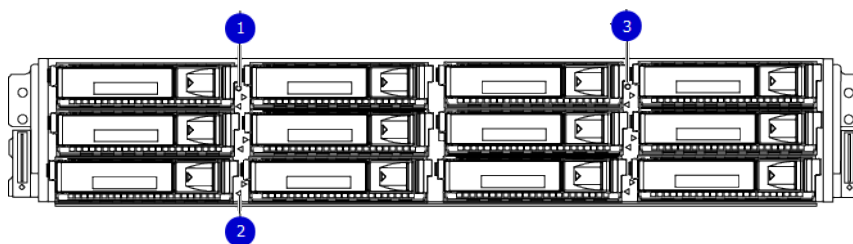
**Table 60. DD6800 DLH expanded configuration drive layout**

Slot 0: HDD 1	Slot 1: HDD 2	Slot 2: HDD 3	Slot 3: HDD 4
Slot 4: SSD 1	Slot 5: SSD 2	Slot 6: SSD 3	Slot 7: SSD 4
Slot 8: Filler	Slot 9: Filler	Slot 10: Filler	Slot 11: Filler

## Front LED indicators

The front of the system contain 12 disk drive status LEDs that are normally blue, and blink when there is activity on the disk. The LEDs are shaped like triangles, and the apex of the triangle points left or right, indicating that disk's status. If the disk drive has a failure, the disk's status LED turns from blue to amber, indicating that a drive must be replaced.

The front also contains two system status LEDs. A blue system power LED is present that is on whenever the system has power. An amber system fault LED is also present that is normally off and lit amber whenever the chassis or any other FRU in the system requires service.



**Figure 71. Front LED indicators**

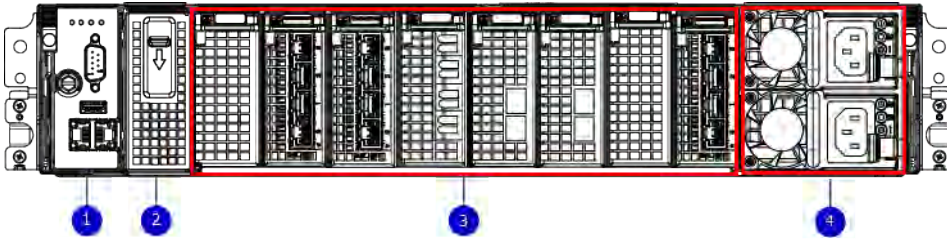
1. System service LED
2. Drive activity/service LED
3. System power LED

**Table 61. Front LEDs**

Name	Color	Purpose
System power LED	Blue	Indication that the system has power.
System service LED	Amber	Normally off; is lit amber whenever the SP or any other FRU (except disk drives) in the system requires service.
Drive activity/Service LED	Blue /Amber	<ul style="list-style-type: none"> <li>• Lit blue when the drive is powered.</li> <li>• Blinks blue during drive activity.</li> <li>• Lit solid amber when a disk needs service.</li> </ul>

# Back panel

The back panel of the chassis contains the following components:



1. Management panel
2. Not Used -- Two 2.5" SSD slots labeled 0 and 1
3. I/O module slots
4. Power supply modules (PSU 0 is the lower module, and PSU 1 is the upper module)

# Rear LED indicators

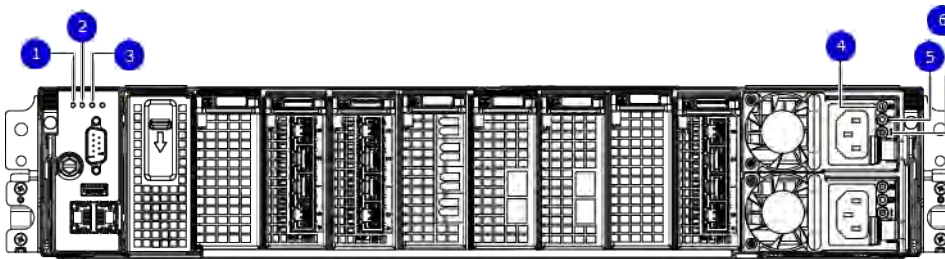


Figure 72. Rear LED indicators

1. Do not remove LED
2. SP service LED
3. System power LED
4. AC power good LED
5. DC power good LED
6. Power supply fault LED

Name of LED	Location	Color	Definition
"Do not remove" LED	Upper left-most part of rear chassis	White	This LED is lit during system BIOS and BMC firmware updates and indicates that the SP should not be removed from the chassis, nor should system power be removed.
SP service LED	To the right of "Do not remove" LED	Amber	<ul style="list-style-type: none"> <li>• Solid amber - SP or a FRU inside the SP requires service</li> <li>• Blinking amber - blink rate reflects one of the following is booting                             <ul style="list-style-type: none"> <li>○ BIOS - 1/4 Hz</li> <li>○ POST - 1 Hz</li> <li>○ OS - 4 Hz</li> </ul> </li> </ul>
Drive Power/Activity LED <sup>a</sup>	Left LED on the SSD	Blue	Lit blue when the drive is powered. Blinks during drive activity.

Name of LED	Location	Color	Definition
Drive Fault LED <sup>a</sup>	Right LED on the SSD	Amber	Lit solid amber when a drive needs service.
System power LED	Right-most LED on the management panel	Blue	SP has good, stable power
PSU FRU LED - AC Good	Top LED on power supply	Green	AC input is as expected
PSU FRU LED - DC Good	Middle LED on power supply	Green	DC output is as expected
PSU FRU LED - Attention	Bottom LED on power supply	Amber	PSU has encountered a fault condition

a. The SSD is only present on DD6300 systems.

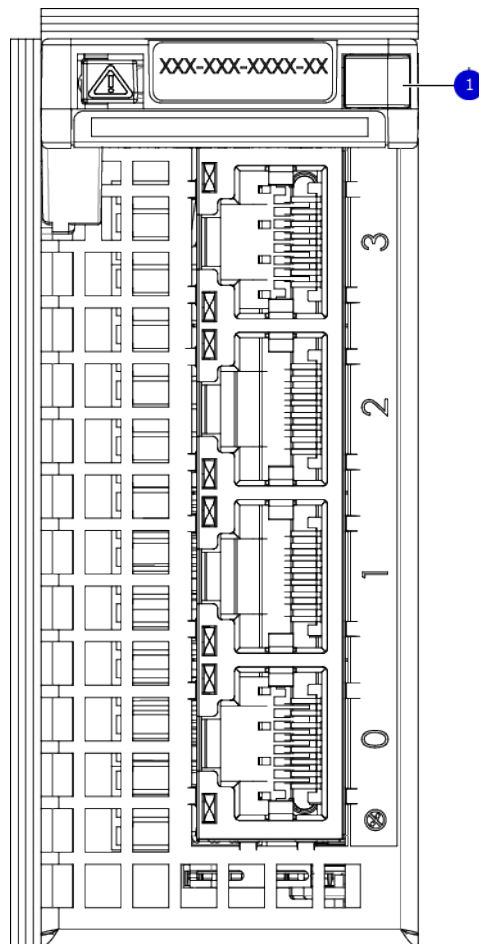


Figure 73. I/O module Power/Service LED location

1. I/O module power/service LED

Table 62. I/O LEDs

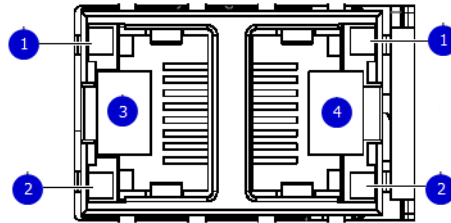
Name of LED	Location	Color	Definition
I/O module FRU LED - I/O module Power/Service LED location on page 129	Ejector handle of I/O modules	Green/Amber	<ul style="list-style-type: none"> <li>Green - I/O module has power and is functioning normally</li> <li>Amber - I/O module has encountered a fault condition and requires service</li> </ul>



**Table 62. I/O LEDs (continued)**

Name of LED	Location	Color	Definition
I/O port status LED (SAS, Fibre Channel, and optical networking I/O modules only)	One LED per I/O module port	Blue	Lit when port is enabled. May flash if SW "marks" the port. <sup>a</sup>

a. For RJ45 networking ports, the standard green link and amber activity LEDs are used.



**Figure 74. Onboard network port LEDs**

1. Network port link LED
2. Network port activity LED
3. Dedicated IPMI port BMC0A
4. Management interface EthMa

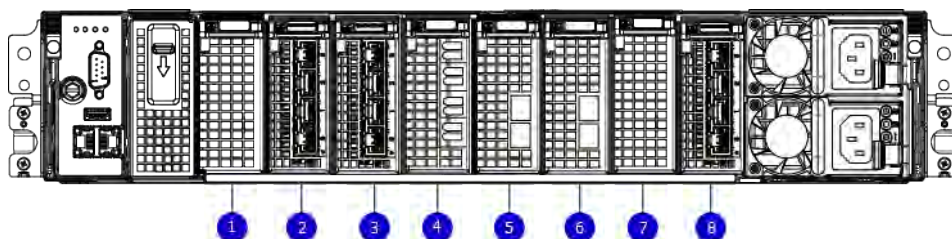
**Table 63. Onboard network port LEDs**

Name of LED	Location	Color	Definition
Onboard network port LED - Link LED <a href="#">Onboard network port LEDs</a> on page 130	Top LED on network port	Green	<ul style="list-style-type: none"> <li>• Lit when there is a link at 1000BaseT and 100BaseT speeds</li> <li>• Off when the link speed is 10BaseT or there is no link</li> </ul>
Onboard network port LED - Activity LED	Bottom LED on network port	Amber	Blinks when there is traffic on the port

## I/O modules

### I/O module slot numbering

The eight I/O module slots are enumerated as Slot 0 (on the left when viewed from the rear) through Slot 7. Ports on an I/O module are enumerated as 0 through 3, with 0 being on the bottom.



**Figure 75. I/O module slot numbering**

1. Slot 0
2. Slot 1
3. Slot 2

4. Slot 3
5. Slot 4
6. Slot 5
7. Slot 6
8. Slot 7

I/O modules are only supported in fixed configurations. The fixed configurations define the exact slots into which the I/O modules may be inserted. The processors directly drive the eight I/O module slots, meaning all slots are full performance.

The non-optional SAS, NVRAM, and 10GBaseT I/O modules are allocated to fixed slots. The optional Host Interface I/O modules are used for front end networking and Fibre Channel connections. The quantity and type of these I/O modules is customizable, and there are many valid configurations.

## slot map

I/O module slots 3–6 contain optional Host Interface I/O modules and can contain specific I/O modules or no I/O modules at all. Slot 0, Slot 1, Slot 2, and Slot 7 are populated with the required I/O modules and are not optional.

**Table 64. I/O module slot mapping**

Tier	Slot 0	Slot 1	Slot 2	Slot 3	Slot 4	Slot 5	Slot 6	Slot 7
DLH DLH Extended Retention/DD Cloud Tier	NVRAM 8g Model 3	Quad Port 10 GBase-T	Quad Port 6 Gbps SAS	Quad Port 10GbE SR, Quad Port 10 GBase-T, or Dual Port 16 Gbps Fibre Channel	Quad Port 10GbE SR, Quad Port 10 GBase-T, or Dual Port 16 Gbps Fibre Channel	Quad Port 10GbE SR, Quad Port 10 GBase-T, or Dual Port 16 Gbps Fibre Channel	Quad Port 10GbE SR, Quad Port 10 GBase-T, or Dual Port 16 Gbps Fibre Channel	Quad Port 6 Gbps SAS
DLH High Availability	NVRAM 8g Model 3	Quad Port 10 GBase-T for HA interconnect	Quad Port 6 Gbps SAS	Quad Port 10GbE SR, Quad Port 10 GBase-T, or Dual Port 16 Gbps Fibre Channel	Quad Port 10GbE SR, Quad Port 10 GBase-T, or Dual Port 16 Gbps Fibre Channel	Quad Port 10GbE SR, Quad Port 10 GBase-T, or Dual Port 16 Gbps Fibre Channel	Quad Port 10GbE SR, Quad Port 10 GBase-T, or Dual Port 16 Gbps Fibre Channel	Quad Port 6 Gbps SAS

## I/O module population rules

The system chassis has eight slots for I/O modules. Slots 0, 1, 2, and 7 are reserved. Slots 3, 4, 5, and 6 support host interface I/O modules. The maximum supported number of any type of host interface I/O module is four.

**NOTE:** A maximum of three Quad Port 10 GBase-T I/O modules are supported in slots 3-6 because of the mandatory Quad Port 10 GBase-T I/O module in slot 1.

The following table assigns rules for populating the I/O modules.

**Table 65. I/O module slot population rules**

Step	I/O module name	Slots	Notes
Step 1: Populate mandatory I/O modules	NVRAM 8g Model 3	0	Mandatory for all configurations
	Quad Port 10 GBase-T	1	Mandatory for all configurations
	Quad Port 6 Gbps SAS	2	Mandatory for all configurations
	Quad Port 6 Gbps SAS	7	Mandatory for all configurations

**Table 65. I/O module slot population rules (continued)**

<b>Step</b>	<b>I/O module name</b>	<b>Slots</b>	<b>Notes</b>
Step 2: Populate all Quad Port 10GbE SR I/O modules	Quad Port 10GbE SR	3, 4, 5, 6	Populate starting from the lowest available slot number.
Step 3: Populate all Quad Port 10 GBase-T I/O modules	Quad Port 10 GBase-T	3, 4, 5, 6	Populate starting from the lowest available slot number. With Quad Port 10 GBase-T in slot 1, max number of Quad Port 10 GBase-T I/O modules are limited to 4.
Step 4: Populate all Dual Port 16 Gbps Fibre Channel I/O modules	Dual Port 16 Gbps Fibre Channel	6, 5, 4, 3	Populate starting from the highest available slot number.

# Internal system components

The following figure shows the layout of the CPUs and DIMMs inside the chassis. The front of the system is at the top of the figure.

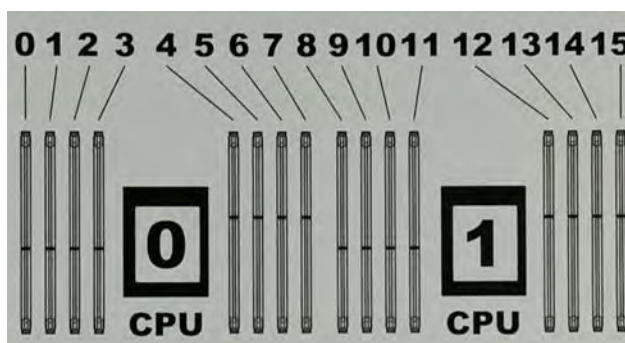


Figure 76. CPU and memory locations

## DIMMs overview

Dual in-line memory modules (DIMM) come in various sizes, which must be configured in a certain way. This topic can help you select the correct configuration when servicing DIMMs.

The storage processor contains two Intel processors each with an integrated memory controller that supports four channels of memory. The storage processor allows two DIMM slots per channel, so the storage processor supports a total of 16 DIMM slots.

## memory DIMM configuration

Table 66. memory DIMM configuration

Tier	Total Memory	Memory DIMM Configuration
DLH	192 GB	8 x 16 GB +8 x 8 GB
DLH Extended Retention/DD Cloud Tier	192 GB	8 x 16 GB +8 x 8 GB

HA is supported with all available memory configurations.

To ensure maximum memory performance, there are memory DIMM population rules for best memory loading and interleaving. [Memory locations - CPU 0](#) on page 133 and [Memory locations - CPU 1](#) on page 133 specify the DIMM location rules for various memory configurations:

Table 67. Memory locations - CPU 0

		Channel A		Channel B		Channel D		Channel C	
Tier	Total Memory	0	1	2	3	4	5	6	7
DLH (Base)	192 GB	16 GB	8 GB	16 GB	8 GB	8 GB	16 GB	8 GB	16 GB
DLH (Expanded)	192 GB	16 GB	8 GB	16 GB	8 GB	8 GB	16 GB	8 GB	16 GB

Table 68. Memory locations - CPU 1

		Channel A		Channel B		Channel D		Channel C	
Tier	Total Memory	8	9	10	11	12	13	14	15
DLH (Base)	192 GB	16 GB	8 GB	16 GB	8 GB	8 GB	16 GB	8 GB	16 GB

**Table 68. Memory locations - CPU 1 (continued)**

DLH (Expanded)	192 GB	16 GB	8 GB	16 GB	8 GB	8 GB	16 GB	8 GB	16 GB
-------------------	--------	-------	------	-------	------	------	-------	------	-------

## DD6800 and ES30 shelf guidelines

The system rediscovers newly configured shelves after it restarts. You can power off the system and recable shelves to any other position in a set, or to another set. To take advantage of this flexibility, you need to follow these rules before making any cabling changes:

- Do not exceed the maximum shelf configuration values for your system as listed in the following table below.
- Use the Installation and Setup Guide for your system to minimize the chance of a cabling mistake.
- A system cannot exceed its maximum raw external shelf capacity, regardless of added shelf capacity.
- DD6800 systems support ES30 SATA shelves after controller upgrades from older models.
- ES30 SATA shelves must be on their own chain.

**Table 69. DD6800 and ES30 shelf configuration**

DD system	Memory required (GB)	SAS cards/port per card	ES30 support (TB)	Max shelves per set	Max number of sets	Max external capacity available (TB) <sup>1</sup>	Max RAW external capacity (TB) <sup>2</sup>
DD6800 w/ HA	192	2x4	SAS 30, 45, 60; SATA 15, 30, 45	7 <sup>3</sup>	4	144	180
DD6800 w/ Expanded Capacity <sup>4</sup>	192	2x4	SAS 30, 45, 60; SATA 15, 30, 45	7 <sup>3</sup>	4	288	360
DD6800 w/ Expanded Capacity w/ HA <sup>6</sup>	192	2x4	SAS 30, 45, 60	7 <sup>3</sup>	4	288	360
DD6800 w/ ER	192	2x4	SAS 30, 45, 60; SATA 15, 30, 45	7 <sup>3</sup>	4	576	720
DD6800 w/ DD Cloud Tier	192	2x4	SAS 30, 45, 60; SATA 15, 30, 45	7 <sup>3</sup>	4	288 (max), additional 96 SAS dedicated to DD Cloud Tier	360 (max), additional 120 SAS dedicated to DD Cloud Tier
DD6800 w/ HA and DD Cloud Tier <sup>4</sup>	192	2x4	SAS 30, 45, 60	7 <sup>3</sup>	4	288 (max), additional 96 SAS dedicated to DD Cloud Tier	360 (max), additional 120 SAS dedicated to DD Cloud Tier

1. This figure only counts drives that have user data in the shelves.

2. The raw capacity of an ES30 is 125% of the available capacity.

3. Recommended configurations start at four shelves per set and expand beyond that as required. For HA configurations, the FS15 counts as a shelf.

4. DDOS 6.x and later and FS15 SSD shelf configuration

## Types of cabinets and power connections

The ES30 chassis is installed in two types of racks: 40U-C (existing racks) and the 40U-P (newer racks). The racks use one phase or 3-phase power connections.

### 3-Phase power connections for 40U-P (current racks)

Some environments use 3-phase power for 40U-P racks that are used for several systems. In those situations, it is desirable to balance the current draw across all three phases. The recommended 3-phase power cabling attempts to do that, but an optimal configuration depends on the specific installation.

## Cabling shelves

### NOTE:


- Before cabling the shelves, physically install all shelves in the racks. Refer to the rail kit installation instructions included with the ES30 shelf for rack mounting.
- The documentation refers to two SAS HBAs. If only one HBA is allowed in a system, then use another port as defined later for that specific system.
- On an HA system, add cables from the second node to open ports at the end of the sets. The ports on the second node must connect to the same sets as the corresponding ports on the first node.

Ports on the system's SAS HBA cards connect directly to a shelf controller's host port. For redundancy, you need to create dual paths by using a port on one SAS HBA card to connect to one shelf controller in each shelf set, and a port on another SAS HBA card to connect to another shelf controller in the same shelf set. With dual paths, if one SAS HBA card fails, the shelf is still operational. However, in the unlikely event any single shelf becomes completely disconnected from power or SAS cables and becomes disconnected from a previously operational shelf, the file system goes down and the shelf is not operational. This is considered a double failure.

There are two kinds of configurations: one shelf in a set or multiple shelves in a set.

## DD6300, DD6800, and DD9300 shelf configurations

There are a few rules that must be followed when adding a mixture of DS60 and other shelf types to your system.

 **CAUTION: If a system does not follow ALL of these rules it is not a legitimate configuration.**

Prerequisites:

- You cannot exceed the maximum amount of raw capacity displayed in the cabling table for each system.
- You cannot exceed the maximum number of shelves displayed in the cabling table for each system.
- There are no specific placement or cabling requirements for SSD shelves, or the metadata shelves for Cloud Tier configurations. These shelves can be installed and cabled the same way as standard ES30 shelves.

**Table 70. Minimum and maximum configurations**

System	Appliance	Minimum appliance shelf count*	Max appliance shelf count
	48 TB usable	0	1
w/ Expansion	144 TB usable	1	5
	144 TB usable	2	28
w/ Expansion	288 TB usable	2	28
w/ High Availability (HA)	288 TB usable	2	28
w/ Extended Retention (ER)	576 TB usable	2	28
w/ Cloud Tier	288 TB usable (96 TB for Cloud Tier)	2	28

**Table 70. Minimum and maximum configurations (continued)**

System	Appliance	Minimum appliance shelf count*	Max appliance shelf count
w/ HA and Cloud Tier	288 TB usable (96 TB for Cloud Tier)	2	28
	384 TB usable	3	28
w/ Expansion	720 TB usable	3	28
w/ HA	720 TB usable	3	28
w/ ER	1440 TB usable	7	28
w/ Cloud Tier	720 TB usable (192 TB for Cloud Tier)	7	28
w/ HA and Cloud Tier	720 TB usable (192 TB for Cloud Tier)	7	28

\* The minimum appliance shelf count does not include shelves for Cloud Tier.

## DD6800 and DS60 shelf guidelines

The system rediscovers newly configured shelves after it restarts. You can power off the system and recable shelves to any other position in a set, or to another set. To take advantage of this flexibility, you need to follow these rules before making any cabling changes:

- Do not exceed the maximum shelf configuration values for your system as listed in the following table.
- For redundancy, the two connections from a system to a set of shelves must use ports on different SAS I/O modules.
- Use the Installation and Setup Guide for your system to minimize the chance of a cabling mistake.
- A system cannot exceed its maximum raw external shelf capacity, regardless of added shelf capacity.
- ES30 SATA shelves must be on their own chain.
- If ES30 SAS shelves are on the same chain as a DS60, the maximum number of shelves on that chain is 5.

**Table 71. DD6800 and DS60 shelf configuration**

DD system	Memory required (GB)	SAS cards/port per card	DS60 support (TB)	Max shelves per set	Max number of sets	Max external capacity available (TB) <sup>1</sup>	Max RAW external capacity (TB)
DD6800 <sup>2, 3, 4</sup>	192	2x4	SAS 45, 60	1	1	144	180
DD6800 w/ Expanded Capacity <sup>2, 3</sup>	192	2x4	SAS 45, 60	1	2	288	360
DD6800 w/ Expanded Capacity and w/ HA <sup>2, 3</sup>	192	2x4	SAS 45, 60	1	2	288	360
DD6800 w/ Expanded Capacity and w/ ER <sup>2, 3</sup>	192	2x4	SAS 45, 60	2	4	576	720
DD6800 w/ Expanded Capacity and w/ Cloud Tier <sup>3, 5</sup>	192	2x4	SAS 45, 60	2	4	288 + 96 for DD Cloud Tier	360 + 120 for DD Cloud Tier
DD6800 w/ Expanded Capacity and w/ Cloud Tier and HA <sup>3, 5</sup>	192	2x4	SAS 45, 60	2	4	288 + 96 for DD Cloud Tier	360 + 120 for DD Cloud Tier



**NOTE:** An entry of 45 corresponds to DS60-3 models and an entry of 60 corresponds to DS60-4 models.

1. This column only counts drives that have user data in the shelves. For example, a DS60 4-240 has 192TB.
2. With DD OS 6.x (or greater) & SSD.
3. Only available with DD OS 6.x and greater.
4. DD6800 base configuration has the same configuration as the DD6800 Expanded. Maximum capacity is limited by capacity license.
5. With Cloud Tier Storage.

## shelf configurations

There are a few rules that must be followed when adding a mixture of DS60 and other shelf types to your system.

**CAUTION:** If a system does not follow all these rules, it is not a legitimate configuration.

Prerequisites:

- You cannot exceed the maximum amount of raw capacity displayed in cabling table for each system.
- You cannot exceed the maximum number of shelves displayed in cabling table for each system.
- You cannot connect more than three DS60 shelves in a single set.

**Table 72. Minimum configurations**

System	Appliance maximum	Minimum appliance DS60 shelf count
	144 TB	0
	144 TB	2
w/ High Availability (HA)	288 TB	2 (plus 1 FS15 for SSD cache)
w/ Extended Retention (ER)	576 TB	2
w/ Cloud Tier	384 TB (96 TB for Cloud Tier)	2 (plus 2 ES30s for Cloud Tier)
w/ HA and Cloud Tier	384 TB (96 TB for Cloud Tier)	2 (plus 1 FS15 for SSD cache, and 2 ES30s for Cloud Tier)
	384 TB	3
w/ HA	720 TB	3 (plus 1 FS15 for SSD cache)
w/ ER	1440 TB	3
w/ Cloud Tier	912 TB (192 TB for Cloud Tier)	3 (plus 4 ES30s or 1 DS60 for Cloud Tier)
w/ HA and Cloud Tier	912 TB (192 TB for Cloud Tier)	4 (plus 1 FS15 for SSD cache, and 4 ES30s or 1 DS60 for Cloud Tier)

1. DS60 will only be partially filled.

- A Cloud Tier system shares the ERSO cabling configuration; however, Cloud Tier has a lower maximum.
- It is recommended that the shelf with the greater number of drives should always be placed in the bottom position.
- only supports one DS60.
- only has one SAS SLIC and all DS60 connections are made to that single SAS SLIC.
- only has one SAS SLIC and all DS60 connections are made to that single SAS SLIC.

# DD6900

This chapter contains the following topics:

## Topics:

- [DD6900 system features](#)
- [DD6900 system specifications](#)
- [DD6900 storage capacity and configurations](#)
- [DD6900 front panel](#)
- [DD6900 SSD usage and configurations](#)
- [Rear panel](#)
- [PCIe HBAs](#)
- [DD6900 DIMM configurations](#)
- [DD6900, DD9400, and DD9900 storage shelves configurations and capacities](#)

## DD6900 system features

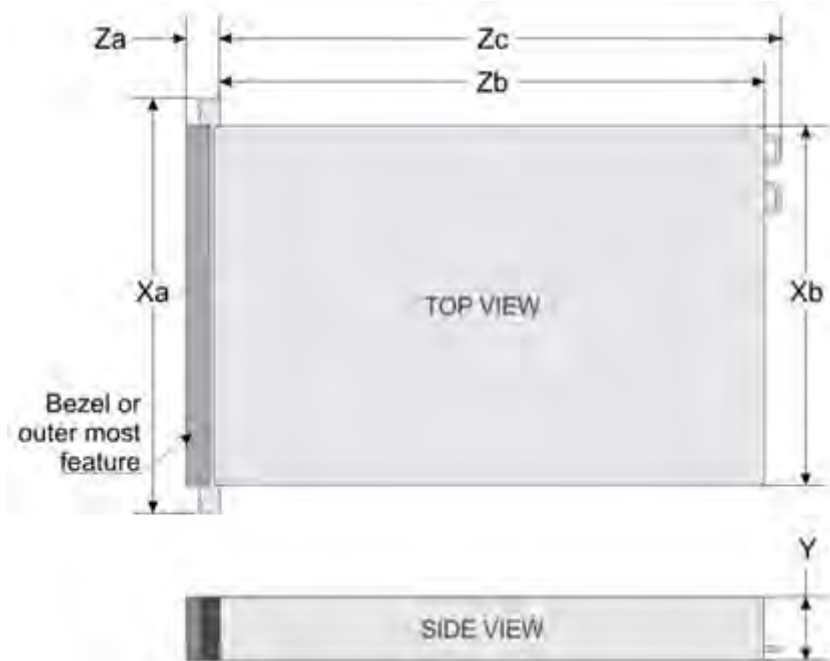
**Table 73. DD6900 system features**

Configurations		Single Node	HA A-P
Processor		2 x Intel Xeon Silver, 2095 Mhz, 8C	
Kernel		4.4	
Memory Configurations	Total	288 GB	
	DIMMs	12 x 8 GB + 12 x 16 GB	
HDD Drive Size		4TB	
Supported Capacity	Active Tier	48 <-> 288 TBu	
	Cloud Tier	576 TBu	
Disk Groups	Active Tier	1 <-> 6	
	Cloud Tier (4 TB)	2	
SSDs for OS in 2.5" bays in head		4, 0.96 TB, 1 WPD	
Stream Count		400 Wr, 110 Rd	
Cache SSDs	1.2%	2 (Internal) 1.92 TB	2 (External) 3.84 TB
Cache SSD shelf	FS25	0	1
HA Private Interconnect		N/A	(2) 10G Base-T ports (NDC)
16 GB NVRAM		1	
HW Accelerator	100 Quick Assist Technology (QAT) 8970	1	
Internal SAS	HBA330 12 Gbps SAS controller	1	
External SAS	PMC Quad Port 12 Gbps SAS	2 minimum, 3 maximum	
SAS String Depth (max)	ES30/ES40	6 (7 for Cloud Tier)	

**Table 73. DD6900 system features (continued)**

Configurations		Single Node	HA A-P
	DS60	2	
Host interface HBAs	2-port QL41000 25 GbE-SFP28	4 maximum	
	4-port QL41164 10 GbE-SFP+	3 maximum	
	4-port QL41164 10GBASE-T	4 maximum	
	4-port QLE2694 16 Gb FC	3 maximum	
Network Daughter Card option	4-port QL41000 10 GbE-SP+ FasLinQ	1	
	4-port QL41164 10GBASE-T	1	

## DD6900 system specifications



**Figure 77. System dimensions**

**Table 74. DD6900 system specifications**

Xa	Xb	Y	Za (with bezel)	Za (without bezel)	Zb	Zc
482.0 mm (18.98 inches)	434.0 mm (17.09 inches)	86.8 mm (3.42 inches)	35.84 mm (1.41 inches)	22.0 mm (0.87 inches)	678.8 mm (26.72 inches)	715.5 mm (28.17 inches)

A DD6900 system weighs up to 63.05 lbs (28.6 kg).

**Table 75. System operating environment**

Operating Temperature	50° to 95° F (10° to 35° C), derate 1.1° C per 1000 feet, above 7500 feet up to 10,000 feet (32.25° C at 10,000)
Operating Humidity	20% to 80%, non-condensing
Non-operating Temperature	-40° to +149° F (-40° to +65° C)

**Table 75. System operating environment (continued)**

Operating Acoustic Noise	L <sub>wad</sub> sound power, 7.5 Bels
--------------------------	--

## DD6900 storage capacity and configurations

The following table provides storage capacity and configuration information for the DD6900 system:

**Table 76. DD6900 storage capacity and configurations**

Tier	CPU-SP SKU	Memory	Front 2.5" SSDs	Max. Useable Capacity	Cloud Tier Metadata
DD6900	8 core, 85 W 4208	288 GB (12 x 16 GB) + (12 x 8 GB)	1 (1.2%)	288 TB	N/A
DD6900 with DD Cloud Tier <sup>1</sup>	8 core, 85 W 4208	288 GB (12 x 16 GB) + (12 x 8 GB)	1 (1.2%)	576 TB	120 TB raw/96 TB usable

<sup>1</sup> DD Cloud Tier can be added to a DD6900 and is enabled by a license and disk packs for the DD Cloud Tier metadata.

The Memory column lists the total memory that is required and the number and type of the DIMMs used. All memory DIMMs are DDR4 RDIMMs at the highest supported speed of 2400MT/s.

## High Availability

DD6900 supports Active-Passive High Availability (A-P HA or just A-P). The following table summarizes the hardware changes to support A-P HA:

**Table 77. HA configuration requirements**

Hardware Change to support HA	Active-Passive HA
Additional memory	No extra memory required.
HA private interconnect	Cluster Interconnect : A-P requires the use of two ports from the on-board quad-port 10 GbE Network Daughter Card.
NVRAM	A-P requires a single 16 GB NVRAM card (same as non-HA).
SAS Connectivity	Both nodes of an A-P HA pair require redundant SAS connectivity to the storage array. (Note: a single node system also has redundant connectivity to the storage array.)
SSD Requirements	SSDs are contained within FS25 and are available from both nodes.

## HA Network Interconnect

The HA Network Interconnect, required for HA configurations, is a dedicated 10 GbE connection between the two nodes of an HA pair. The interconnect is used to write data (and metadata) from the active node's NVRAM to the passive node's NVRAM.

Two 10GbE links are used to meet the bandwidth requirements for the private interconnect. Traffic across the private interconnect has roughly the same bandwidth as is written to the NVRAM card. The dual 10-GbE links can move about 2 GB/s in each direction.

## HA SAS Interconnect

HA configurations require that the SSDs' cache drives be shared between both nodes and have redundant SAS connections to all shelves.

# DD6900 front panel



Figure 78. DD6900 front panel

Table 78. Front panel features

Item	Ports, panels, and slots	Description
1	Left control panel	Contains system health and system ID, status LED, and optional iDRAC Quick Sync 2 (wireless).
2	Drive slots	Enable you to install drives that are supported on your system.
3	Right control panel	Contains the power button, VGA port, iDRAC Direct micro USB port, and two USB 2.0 ports.
4	Information tag	The Information tag is a slide-out label panel that contains system information such as Service Tag, NIC, MAC address, and so on. If you have opted for the secure default access to iDRAC, the Information tag also contains the iDRAC secure default password.

Table 79. Front LEDs

Name	Color	Purpose
Control Panel Status LED	Blue/Amber	Status: <ul style="list-style-type: none"> <li>● Healthy: Solid Blue</li> <li>● Fault: Blink Amber</li> <li>● Sys ID: Blink Blue</li> </ul>
System Power Button/LED	Green	Indication that the system has power.
Drive activity LEDs	Green	Lit green when the drive is powered. Blinks during drive activity.
Drive service LEDs	Green	Lit solid amber when a disk drive needs service.

## Front LEDs

Figure 79. Front left control panel status LEDs



**NOTE:** The indicators display solid amber if any error occurs.

**Table 80. System health and system ID indicator codes**

System health and ID indicator code	
Solid blue	Indicates that the system is turned on, system is healthy, and system ID mode is not active. Press the system health and system ID button to switch to system ID mode.
Blinking blue	Indicates that the system ID mode is active. Press the system health and system ID button to switch to system health mode.
Solid amber	Indicates that the system is in fail-safe mode.
Blinking amber	Indicates that the system is experiencing a fault. Check the System event log or the LCD panel, if available on the bezel, for specific error messages.



**Figure 80. Front right control panel power button LEDs**

**Table 81. Right control panel features**

Item	Indicator, button, or connector	Description
1	Power button	Indicates if the system is turned on or off. Press the power button to manually turn on or off the system. <b>NOTE:</b> Press the power button to gracefully shut down an ACPI-compliant operating system.

**Table 81. Right control panel features (continued)**

Item	Indicator, button, or connector	Description
2	USB port (2)	The USB ports are 4-pin, 2.0-compliant. These ports enable you to connect USB devices to the system.
3	iDRAC Direct port	The iDRAC Direct port is micro USB 2.0-compliant. This port enables you to access the iDRAC Direct features.
4	iDRAC Direct LED	The iDRAC Direct LED indicator lights up to indicate that the iDRAC Direct port is connected.
5	VGA port	Enables you to connect a display device to the system.

**Table 82. iDRAC Direct LED indicator codes**

iDRAC Direct LED indicator code	Condition
Solid green for two seconds	Indicates that the laptop or tablet is connected.
Flashing green (on for two seconds and off for two seconds)	Indicates that the laptop or tablet that is connected is recognized.
Turns off	Indicates that the laptop or tablet is unplugged.



**Figure 81. Drive LEDs**

The front contains 25 2.5" disk drive slots that can be populated with SSDs. Each SSD is housed in a drive carrier that contains two LEDs at the bottom of the carrier. The carrier's left blue LED is lit whenever an SSD is present in the slot, and it blinks when I/O activity is occurring on the disk. The right amber LED is usually off and lights amber to indicate that the disk is faulted and must be serviced.

## DD6900 SSD usage and configurations

DD6900 system uses an 8 x 2.5" drive slot mid-plane. In addition to the DD OS drives, it allows up to four SSDs for the metadata cache implementation.

### SSD configurations

The SSD slots on the front of the enclosure are shown below. The system come from the factory with SSDs populated in the enclosure.





**Figure 82. DD6900 SSD slot assignment**

DD6900 supports 1.2% SSD options out of factory configurations. Based on 3.84 TB SSD capacity, the required number of SSDs for each DD6900 configuration is provided in the following table.

**Table 83. DD6900 SSD configurations**

Configuration	Single node	HA
3.84 TB SSDs in 2.5" bays	2 (internal) 1.92 TB	2 (External) 3.84 TB

The cache SSDs are installed right to left starting from slot 7 down.

## SSD boot drives

Additional SAS SSDs are used to boot the DD OS operating system. Boot disks and/or external disk shelves are used to log system information. Boot disks are installed from the other end of the front 2.5" disk slots to physically differentiate the cache SSDs.

**Table 84. SSD boot drives**

# of boot disks	Installed in slots
4	0,1,2,3

## Rear panel



**Figure 83. System rear panel**

Item	Panels, ports, and slots	Description
1	Full-height PCIe expansion card slot (3)	The PCIe expansion card slot (riser 1) connects up to three full-height PCIe expansion cards to the system.

Item	Panels, ports, and slots	Description
2	Half-height PCIe expansion card slot	The PCIe expansion card slot (riser 2) connects one half-height PCIe expansion cards to the system.
3	Rear handle	The rear handle can be removed to enable any external cabling of PCIe cards that are installed in the PCIe expansion card slot 6.
4	Full-height PCIe expansion card slot (2)	The PCIe expansion card slot (riser 2) connects up to two full-height PCIe expansion cards to the system.
5	Full-height PCIe expansion card slot (2)	The PCIe expansion card slot (riser 3) connects up to two full-height PCIe expansion cards to the system.
6	Power supply unit (2)	Supports two AC power supply units (PSUs)
7	NIC ports	The NIC ports that are integrated on the network daughter card (NDC) provide network connectivity.
8	USB port (2)	The USB ports are 9-pin and 3.0-compliant. These ports enable you to connect USB devices to the system.
9	VGA port	Enables you to connect a display device to the system.
10	Serial port	Enables you to connect a serial device to the system.
11	iDRAC9 dedicated port	Enables you to remotely access iDRAC.
12	System identification button	The System Identification (ID) button is available on the front and back of the systems. Press the button to identify a system in a rack by turning on the system ID button. You can also use the system ID button to reset iDRAC and to access BIOS using the step through mode.

## Rear LEDs



**Figure 84. Onboard ID and iDRAC LEDs**

1. iDRAC management port:
  - a. The green link LED on the left is lit whenever there is link at 1000BaseT and 100BaseT speeds. The link LED is off when the link speed is 10BaseT or there is no link.
  - b. The green link LED on the right blinks whenever there is traffic on the port.
2. System identification LED: This blue LED can be turned on by software to visually identify the system.

## PSU FRU LEDs

There are two power supplies, one in the upper left of the rear chassis and one on the bottom right. Each power supply has three LEDs: AC good, DC good, and Service. The top PSU is "right-side up" and the bottom PSU is "upside down."

**Table 85. PSU FRU LEDs**

Name	Color	Definition
AC Good	Green	AC input is as expected.
DC Good	Green	DC output is as expected.
Service	Amber	PSU has a fault condition and a must be replaced.

## PCIe HBAs

A slot in the chassis that does not contain an HBA must have a filler panel installed in the empty slots. This is required for EMI compliance.

This system supports nine I/O modules slots, seven of which are 8-lane PCIe Gen3, and two are 16-lane PCIe Gen3. Several networking, NVRAM, SAS, and Fibre Channel I/O modules are supported.

## Slot assignment

The following table lists the DD6900 configuration slot assignments:

**Table 86. DD6900 slot assignments**

Description	Slot
QLogic, 41164 4 Port, 10GbE SFP+ PCIe, Full Height	5, 8, 1
QLogic, 41164 4 Port, 10GBASE-T PCIe, Full Height	5, 8, 1
QLogic, 41164 4 Port, 10GBASE-T PCIe, Low Profile	6
QLogic, 41262 2 Port, 25Gb SFP28 PCIe, Full Height	5, 8, 1
QLogic, 41262 2 Port, 25Gb SFP28 PCIe, Low Profile	6
HBA330 SAS Controller, 12Gbps Mini card	mini/mono
QAT,INTEL,8970,FH, Avnet p/n 1QA89701G1P5	4
PM8072,SAS12,4P,FH, MicroSemi 2295200-R	3, 7, 5
FC16,QLE2694-DEL-BK,TRG,QP,FH	5, 8, 1
16GB NVRAM,FH	2

Host Interface (x16) is 2-port 100 Gb QSFP+ Ethernet.

Host Interface (x8) are:

- 4-port 25 Gb SFP28 Ethernet
- 4-port 10 Gb SFP+ Ethernet
- 4-port 10GBaseT Ethernet
- 4-port 16 Gb Fibre Channel

**i NOTE:** Any of the Host Interface (x8) may be inserted into the slots 1, 2, & 5, but the Host Interface (x16) may only reside in slot 2 (the x16 slots).

SAS is 4-port 12 Gb SAS and is required for HA configurations.

NVRAM is the 16GB NVRAM.

SAS Mezzanine is 2-port 12 Gb Mini-SAS HD SAS controller mezzanine.

Host Interface Mezzanine is either:

- 4-port 10GBaseSR SFP+ Ethernet mezzanine
- 4-port 10GBaseT RJ45 Ethernet mezzanine

## I/O population rules

The following figures show the I/O module slot numbers.

The slot labeled N is the network daughter card, which contains ports ethMa, ethMb, ethMc, and ethMd.

The physical interface name format for the other I/O module slots is ethXy, where X is the slot number and y is an alphanumeric character. For example, eth0a.

For most horizontal I/O module NIC interfaces, the port numbering goes from left to right, with ethXa on the left. The horizontal I/O module slots on the left-in slots 1-3 are inverted. The port numbering on these I/O modules in these slots goes from right to left, with ethXa on the right.

The management port ethMa is the first port set up by the Configuration Wizard. It is marked with a red rectangle in the figure below.



Figure 85. Slot numbering

The general population rules can be summarized as:

1. Populate a given I/O in the available slots listed.
2. Select the first available slot in the group.
3. Follow the steps for each I/O in the order specified.
4. Slots 0 and 2 should be reserved for x16 unless there are no available x8 slots.

**NOTE:** Installing HBAs requires opening the system and installing the HBA into the riser.

Riser#	Slots (from top to bottom)
1	1, 2, 3
2	4, 5, 6, N
3	7, 8

## Gen3 PCIe

Slots support Gen3 PCIe.

## I/O module servicing

All I/O modules are user serviceable and may be replaced when the system is powered off. On-line service of I/O modules is not support. A module that is hot-inserted into the system will remain powered off and will not be powered on until the next reboot of the system. A module that is hot-removed causes an operating system to immediately reboot.

## DD6900 DIMM configurations

The SP Module contains two Intel SP processors each with an integrated memory controller that supports six channels of DDR4 memory. The CPU enables two DIMM slots per channel, so the SP Module supports 24 DIMM slots.

Each DDR4 DIMM is connected to the system board through an industry standard 288-pin DDR4 DIMM connector. This system uses registered DIMMs with Dell EMC ControlCenter at 72 bits wide (64-bits data + 8-bits Dell EMC ControlCenter) up to a maximum of 2400MT/s speed.

**Table 87. Memory configurations**

Tier	Total Memory	Memory DIMM Configuration
DD6900	288 GB	12 x 8GB + 12 x 16GB
DD6900 Cloud Tier	288 GB	12 x 8GB + 12 x 16GB

## Memory locations

To ensure maximum memory performance, there are memory DIMM population rules so that the memory loading and interleaving are optimal. The following table specifies the DIMM location rules. Each DIMM location contains either a 16GB DIMM or a 32GB DIMM.

**Table 88. DD6900 DIMM configuration CPU 1**

Total (GB)	Channel C		Channel B		Channel A		Channel D		Channel E		Channel F	
	J0	J1	J2	J3	J4	J5	J6	J7	J8	J9	J10	J11
192	16GB	8GB	16GB	8GB	16GB	8GB	8GB	16GB	8GB	16GB	8GB	16GB

**Table 89. DD6900 DIMM configuration CPU 2**

Total (GB)	Channel C		Channel B		Channel A		Channel D		Channel E		Channel F	
	J12	J13	J14	J15	J16	J17	J18	J19	J20	J21	J22	J23
192	16GB	8GB	16GB	8GB	16GB	8GB	8GB	16GB	8GB	16GB	8GB	16GB

## DD6900, DD9400, and DD9900 storage shelves configurations and capacities

DD6900, DD9400, and DD9900 do not store data on internal disk drives and rely on external disk array shelves to provide storage. DS60 disk shelves and ES40 shelves are connected to systems using 12 Gb Mini-SAS HD ports, which are implemented on the SAS HBAs.

The systems also support external metadata storage (cache) shelf FS25. External cache shelf only hosts DD OS depended metadata for performance acceleration.

The ES40 SAS shelf contains 15 drives, which includes 12 drives of usable storage, two parity drives, and one hot spare.

The DS60 shelf contains 60 drives. Drives are configured in four groups of 15 drives. Each group contains two parity drives and one hot spare, so each group provides 12 drives of usable storage. A fully configured DS60 shelf provides 48 drives of usable storage.

**Table 90. Shelves shipped from factory, in rack**

DD6900	DD9400	DD9900
4 TB ES40	8 TB DS60	8 TB DS60

**Table 91. Shelves shipped from factory, boxed**

DD6900	DD9400	DD9900
4 TB ES40	8 TB ES40	8 TB ES40
4 TB DS60	8 TB DS60	8 TB DS60

**Table 92. Additional shelves supported**

DD6900	DD9400	DD9900
4 TB SAS ES30/DS60	4 TB SAS ES30/DS60	4 TB SAS ES30/DS60

**Table 92. Additional shelves supported (continued)**

DD6900	DD9400	DD9900
3 TB SAS ES30/DS60	3 TB SAS ES30/DS60	3 TB SAS ES30/DS60

**NOTE:** 3 TB shelves are only support on controller upgrades and not on fresh installs.

**Table 93. Shelf usable capacities**

Hard drive size (TB)	Shelf	Useable TB
4	ES40	48
4	DS60	192
8	DS60	384

The following table lists the maximum number of shelves per chain:

**Table 94. Supported shelf count per chain**

Shelf type	Max # from factory	Max # per chain
SAS ES30/ES40	4	7
DS60	2	3
DS60 + ES30/ES40	n/a	5
F25	1	1

The connector type for ES30 is Mini-SAS. Special cables may be necessary when combining ES30 and ES40 shelves on the same chain (enabled but not recommended).

DD9400 and DD9900 system capacities are optimized for use with DS60 shelves containing 8 TB drives. DS60 shelves can be populated with one to four packs of fifteen 8 TB, or 4 TB drives. Different 4 TB and 8 TB capacity disk packs may be mixed within a single DS60 shelf. ES40 SAS shelves and DS60 shelves of mixed capacities may be attached so long as the maximum storage capacity of the system is not exceeded.

# DD7200

This chapter contains the following topics:

**Topics:**

- [DD7200 system features](#)
- [DD7200 system specifications](#)
- [DD7200 storage capacity](#)
- [Front Panel](#)
- [Back Panel](#)
- [I/O modules and slot assignments](#)
- [Internal system components](#)
- [DD7200 and ES30 shelf guidelines](#)
- [DD7200 and DS60 shelf guidelines](#)



# DD7200 system features

The table summarizes the DD7200 system features.

**Table 95. DD7200 system features**

Feature		DD7200 (Base configuration)	DD7200 (Expanded configuration)
Rack height		4U, supported in four-post racks only	4U, supported in four-post racks only
Rack mounting		Rack mount kit included with each system. Adjustable between 24 - 36 in. (60.9 - 76.2 cm).	Rack mount kit included with each system. Adjustable between 24 - 36 in. (60.9 - 76.2 cm).
Power		1 +1 redundant, hot-swappable power units	1 +1 redundant, hot-swappable power units
Processor		Two 8-core processors	Two 8-core processors
NVRAM		One 4-GB NVRAM module (and companion BBU) for data integrity during a power outage	One 4-GB NVRAM module (and companion BBU) for data integrity during a power outage
Fans		Hot-swappable, redundant, 5	Hot-swappable, redundant, 5
Memory		8 x 16 GB DIMM (128 GB)	16 x 16 GB DIMM (256 GB)
Internal drives		SSD drives, 3 x 200 GB (base 10)	SSD drives, 3 x 200 GB (base 10)
I/O module slots		Nine replaceable I/O module (Fibre Channel, Ethernet, and SAS) slots, one BBU, one NVRAM, and one Management module slot. See <a href="#">Management module and interfaces</a> on page 45 and <a href="#">I/O modules and slot assignments</a> on page 47.	Nine replaceable I/O module (Fibre Channel, Ethernet, and SAS) slots, one BBU, one NVRAM, and one Management module slot. See <a href="#">Management module and interfaces</a> on page 45 and <a href="#">I/O modules and slot assignments</a> on page 47.
Supported capacity	Non-extended retention	12 x 2-TB or 8 x 3-TB shelves adding up to 285 TB of usable external capacity.	8 x 2-TB or 12 x 3-TB shelves adding up to 428 TB of usable external capacity.
	DD Cloud Tier	N/A	428 TB of Active Tier capacity, and 856 TB of Cloud Tier capacity. 4 x 4 TB shelves are required to store DD Cloud Tier metadata.
	DD Extended Retention	N/A	56 shelves adding up to a maximum of 856 GB of usable external capacity.

# DD7200 system specifications

**Table 96. DD7200 system specifications**

Model	Watts	BTU/hr	Power	Weight	Width	Depth	Height
DD7200	800	2730	800	80 lb / 36.3 kg	17.5 in (44.5 cm)	33 in (84 cm)	7 in (17.8 cm)

**Table 97. System operating environment**

Operating Temperature	50° to 95° F (10° to 35° C), derate 1.1° C per 1000 feet, above 7500 feet up to 10,000 feet
Operating Humidity	20% to 80%, non-condensing
Non-operating Temperature	-40° to +149° F (-40° to +65° C)
Operating Acoustic Noise	Sound power, LWAd: 7.52 bels. Sound pressure, LpAm: 56.4 dB. (Declared noise emission per ISO 9296.)

## DD7200 storage capacity

The table lists the capacities of the systems. Data Domain system internal indexes and other product components use variable amounts of storage, depending on the type of data and the sizes of files. If you send different datasets to otherwise identical systems, one system may, over time, have room for more or less actual backup data than another.

**Table 98. DD7200 storage capacity**

System/ Installed Memory	Internal Disks (SATA SSDs)	Data Storage Space	External Storage <sup>3</sup>
DD7200 (2 SAS I/O modules) 128 GB	2.5 in. 3 @ 200 GB No User Data	285 TB	Up to a maximum of 12 x 2-TB or 8 x 3-TB shelves.
DD7200 (2 SAS I/O modules) 256 GB	2.5 in. 3 @ 200 GB No User Data	428 TB	Up to a maximum of 18 x 2-TB or 12 x 3-TB shelves.
DD7200 with DD Cloud Tier <sup>1</sup> (4 SAS I/O modules) 256 GB	2.5 in. 3 @ 200 GB No User Data	<ul style="list-style-type: none"> <li>• 428 TB (Active Tier)</li> <li>• 192 TB (DD Cloud Tier metadata)</li> <li>• 856 TB (DD Cloud Tier)</li> </ul>	Up to a maximum of 18 x 2-TB or 12 x 3-TB shelves. 4x4-TB shelves for DD Cloud Tier metadata.
DD7200 with Extended Retention software <sup>1</sup> (4 SAS I/O modules) 256 GB	2.5 in. 3 @ 200 GB No User Data	856 TB	Up to a maximum of 36 x 2-TB or 24 x 3-TB shelves.

<sup>1</sup>Data Domain DD7200 controller with DD Extended Retention software.

<sup>2</sup> Data Domain DD7200 controller with DD Cloud Tier.

<sup>3</sup> The capacity differs depending on the size of the external storage shelves used. This data based on ES30 shelves.

# Front Panel

The photo shows the hardware features and interfaces on the front of the system.

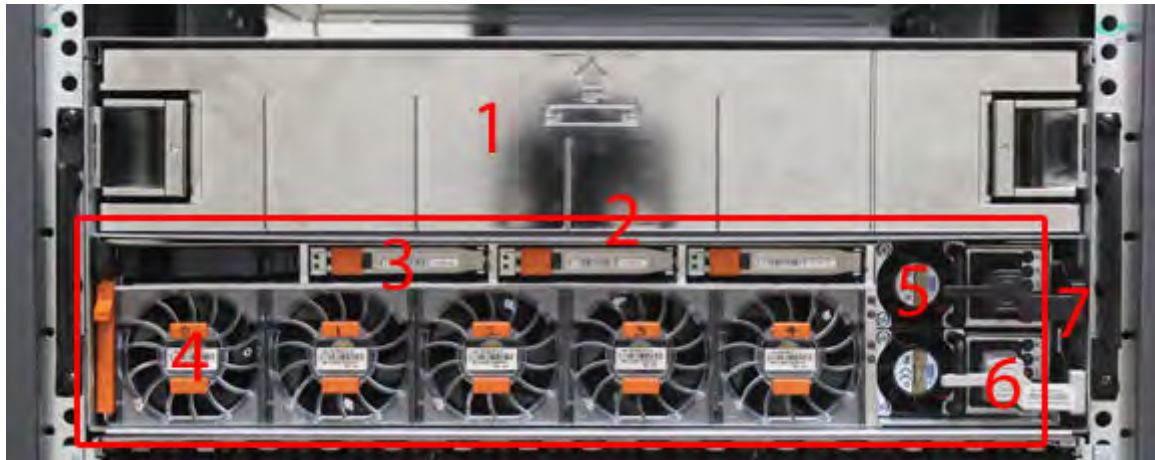


Figure 86. Front panel components

(1)	Filler panel
(2)	The red box indicates the system processor (SP) module
(3)	SSD drive #1
(4)	Fan #0
(5)	Power supply #B
(6)	AC power disconnect plug
(7)	AC power extender module

## Power supply units

A system has two power supply units, numbered A and B from the bottom up. Each power supply has its own integral cooling fan. Each power unit has three LEDs (see [System LED legend label](#) on page 43) that indicates the following states:

- AC LED: Glows green when AC input is good
- DC LED: Glows green when DC output is good
- Symbol “!”: Glows solid or blinking amber for fault or attention

The AC power plugs are located to the right of each power supply. These plugs are pulled to disconnect AC power to each power supply.

## AC power extender module

AC power entry is connected at the rear of the system. The AC power extender module provides power to the two power supplies on the front of the system. AC Power plugs are located in the front. The module is adjacent to the SP module and can be removed and replaced.

## Cooling Fans

A system contains five hot-swappable cooling fans in a 4+1 redundant configuration. The fans provide cooling for the processors, DIMMs, IO modules, and the management module. Each fan has a fault LED which causes the fan housing to glow amber. A system can run with one fan faulted or removed.

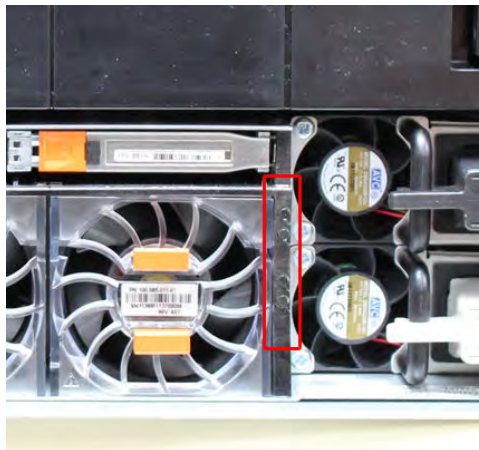
## Solid-state drives

A system contains three hot-swappable 2.5" solid-state drive (SSD) bays that are located in the front and on top of the fan modules. There are four drive bays, with the left-most bay containing a blank. The next drive to the right of the blank is SSD #1, the next is #2, and the right-most bay contains SSD #3. No user backup data is kept on the SSDs.

Each drive has a blue colored power LED and an amber fault LED.

## Front LED Indicators

The photo below indicates the location of the four system LEDs.



**Figure 87. System LEDs**

The next photo shows the location of the system LED legend label. [Power supply LEDs](#) on page 156 shows the power supply LEDs. Other front LEDs are shown in [Fan and SSD LEDs](#) on page 157. LED states are described in [LED status indicators](#) on page 157.

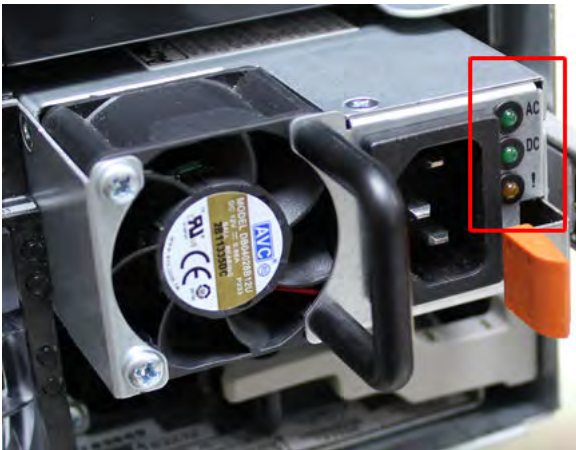


**Figure 88. System LED legend label**

The power supply LEDs include:

- AC LED on top
- DC LED in the middle
- Failure LED on the bottom

**Figure 89. Power supply LEDs**



Each SSD has two LEDs as shown in the following figure. The lower left corner of the housing around each fan acts as an LED, glowing amber when the fan has failed.



**Figure 90. Fan and SSD LEDs**

**Table 99. LED status indicators**

Part	Description or Location	State
System	Dot within a circle (top LED)	Blue indicates power on and normal operation.
System, SP fault	Exclamation point within a triangle	Dark indicates normal operation. Amber indicates failure.
System, chassis fault	Exclamation point within a triangle with a light below	Dark indicates normal operation. Yellow indicates a fault condition.
System	Marked out hand within a black square (bottom LED)	White warns not to remove the unit.
Power supply	AC LED	Steady green indicates normal AC power.
Power supply	DC LED	Steady green indicates normal DC power.
Power supply	Failure LED	Solid amber indicates a failed power supply.
SSD	Top LED	Solid blue, disk ready, blinks while busy.
SSD	Bottom LED	Dark indicates healthy. Solid amber indicates disk fail.
Fan	Fan housing	The fan housing glows an amber color during fan failure.







**Figure 92. Interfaces on the management module**

- 1 - Ethernet port
- 2 - USB port
- 3 - Micro serial port

# I/O modules and slot assignments

The table shows the I/O module slot assignments for the systems. See [Features on rear of chassis](#) on page 45 for a view of the slot positions on the back panel and [Top view of SP module with SP cover removed](#) on page 49 for a top view.

**Table 100. DD7200 slot assignments**

Slot Number	DD7200	DD7200 with Extended Retention Software	DD7200 with DD Cloud Tier
MGMT A	Management module	Management module	Management module
0	Fibre Channel (FC), Ethernet or empty	FC, Ethernet or empty	FC, Ethernet or empty
1	FC, Ethernet or empty	FC, Ethernet or empty	FC, Ethernet or empty
2	FC, Ethernet or empty	FC, Ethernet or empty	FC, Ethernet or empty
3	FC, Ethernet or empty	FC, Ethernet or empty	FC, Ethernet or empty
4	Ethernet or empty	Ethernet or empty	Ethernet or empty
5	Ethernet or empty	SAS	SAS
6	Empty	SAS	SAS
7	SAS	SAS	SAS
8	SAS	SAS	SAS
9	BBU	BBU	BBU
10	NVRAM	NVRAM	NVRAM

## Slot addition rules

- A maximum of six optional I/O modules (FC plus Ethernet) are allowed in systems without Extended Retention software, and a maximum of five optional I/O modules (FC plus Ethernet) are allowed in systems with Extended Retention software.
- Additional FC modules should be installed in numerically increasing slot numbers immediately to the right of the existing FC modules, or starting in slot 0 if no FC modules were originally installed. A maximum of four FC modules are allowed in a system.
- Additional Ethernet modules should be installed in numerically decreasing slot numbers immediately to the left of the existing Ethernet modules or starting in slot 4 if no Ethernet modules were originally installed. For systems without Extended Retention software, a maximum of six (limited to four of any one type) Ethernet modules can be present. For systems with Extended Retention software, a maximum of five (limited to four of any one type) Ethernet modules can be present.
- All systems include two SAS modules in slots 7 and 8. Systems with Extended Retention software must have two additional SAS modules in slots 5 and 6.
- For systems without Extended Retention software, if adding I/O modules results in the allowed maximum of six I/O modules present, slot 5 is used. Slot 5 is only used for an Ethernet module. Adding FC modules in this specific case require moving an existing Ethernet module to slot 5. Other than this specific case, it is not recommended to move I/O modules between slots.
- Adding Extended Retention software to a system includes adding two SAS modules in slots 5 and 6. If the system originally had the maximum of 6 optional I/O modules, the I/O module in slot 5 must be permanently removed from the system.

## Fibre Channel (FC) I/O Module Option

An FC I/O module is a dual-port Fibre Channel module. The optional virtual tape library (VTL) feature requires at least one FC I/O module. Boost over Fiber Channel is optional and the total FC HBAs cannot exceed more than allowable Fibre Channel cards per controller.

## Ethernet I/O Module Options

The available Ethernet I/O modules are:

- Dual Port 10GBase-SR Optical with LC connectors

- Dual Port 10GBase-CX1 Direct Attach Copper with SPF+ module
- Quad Port 1000Base-T Copper with RJ-45 connectors
- Quad port 2 port 1000Base-T Copper (RJ45) /2 port 1000Base-SR Optical

# Internal system components

The photo shows the system with the system processor (SP) module that is removed from the chassis and the SP cover removed.



**Figure 93. Top view of SP module with SP cover removed**

- 1 - Front of system
- 2 - Four groups of 4 DIMM cards

## DIMM modules

- DD7200 systems with 128 GB of memory contain 8 x 16 GB DIMMs, with 8 empty DIMM slots.
- DD7200 systems with 256 GB of memory contain 16 x 16 GB DIMMs.

## DD7200 and ES30 shelf guidelines

The Data Domain system rediscovers newly configured shelves after it restarts. You can power off the system and recable shelves to any other position in a set, or to another set. To take advantage of this flexibility, you need to follow these rules before making any cabling changes:

- Do not exceed the maximum shelf configuration values for your Data Domain system as listed in the following table below.
- Use the Installation and Setup Guide for your Data Domain system to minimize the chance of a cabling mistake.
- A Data Domain system cannot exceed its maximum raw external shelf capacity, regardless of added shelf capacity.
- ES30 SATA shelves must be on their own chain.

### **i** NOTE:

- ES30 SAS shelves must be running DD OS 5.4 or later.
- ES30-45 SATA shelves must be running DD OS 5.4 or later.
- DD OS 5.7 and later support 4TB drives.

**Table 101. DD7200 and ES30 shelf configuration**

DD system	Memory required (GB)	SAS cards/port per card	ES30 support (TB)	Max shelves per set	Max number of sets	Max external capacity available (TB) <sup>1</sup>	Max RAW external capacity (TB) <sup>2</sup>
DD7200	128	2x4	SAS 30, 45; SATA 15, 30, 45 <sup>3</sup>	5 <sup>4</sup>	4	192	256
DD7200	256	2x4	SAS 30, 45, 60; SATA 15, 30, 45 <sup>3</sup>	5 <sup>4</sup>	4	384	540
DD7200 ER <sup>5, 6</sup>	256	4x4	SAS 30, 45, 60; SATA 15, 30, 45 <sup>3</sup>	7	8	768	1024
DD7200 w/ DD Cloud Tier <sup>7</sup>	256	2x4	SAS 30, 45, 60; SATA 15, 30, 45 <sup>3</sup>	5 <sup>4</sup>	4	384 (max), additional 192 SAS dedicated to DD Cloud Tier	512 (max), additional 240 SAS dedicated to DD Cloud Tier

1. This figure only counts drives that have user data in the shelves.
2. The raw capacity of an ES30 is 125% of the available capacity.
3. ES30-45 (SATA) is only supported with DD OS 5.4 or later.
4. 5 shelves maximum with ES30, 4 is the recommended maximum. 4 shelves maximum with ES20, 3 is the recommended maximum.
5. With Extended Retention software.
6. The maximum shelf count for any specific drive/shelf size might be less than the product of max shelves x max shelves per set.
7. Only available with DD OS 6.0.

## Single phase power connections for 40U-P (current racks)

The following figures show single phase power connections for several Data Domain systems.



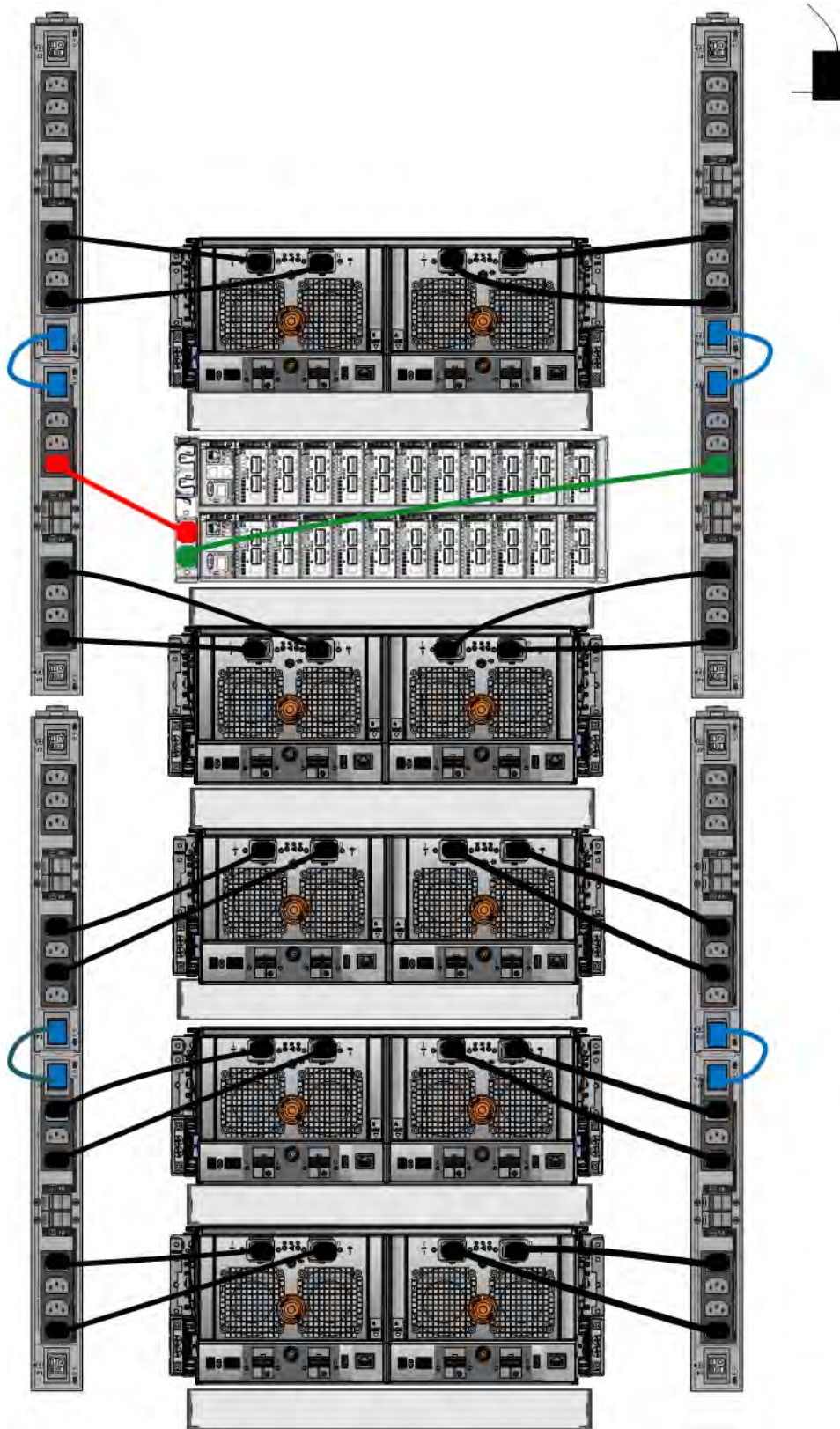


Figure 94. Single phase power connections for DD4200, DD4500, and DD7200 systems

## Cabling shelves

**NOTE:**



- Before cabling the shelves, physically install all shelves in the racks. Refer to the rail kit installation instructions included with the ES30 shelf for rack mounting.
- The documentation refers to two SAS HBAs. If only one HBA is allowed in a system, then use another port as defined later for that specific system.
- On an HA system, add cables from the second node to open ports at the end of the sets. The ports on the second node must connect to the same sets as the corresponding ports on the first node.

Ports on the system's SAS HBA cards connect directly to a shelf controller's host port. For redundancy, you need to create dual paths by using a port on one SAS HBA card to connect to one shelf controller in each shelf set, and a port on another SAS HBA card to connect to another shelf controller in the same shelf set. With dual paths, if one SAS HBA card fails, the shelf is still operational. However, in the unlikely event any single shelf becomes completely disconnected from power or SAS cables and becomes disconnected from a previously operational shelf, the file system goes down and the shelf is not operational. This is considered a double failure.

There are two kinds of configurations: one shelf in a set or multiple shelves in a set.

## ES30 and DD7200 cabling

There are a few rules that must be followed when adding a mixture of ES20, ES30 SATA, and ES30 SAS shelves to your system. If a system does not follow ALL of these rules it is not a legitimate configuration.

Prerequisites:

- Follow the minimum and maximum shelf capacity configuration provided in the table.
- You cannot have ES20 and ES30 shelves in the same set.
- You cannot have ES30 SATA and ES30 SAS shelves in the same set.
- You cannot exceed the maximum amount of raw capacity displayed in the product's cabling table.
- The maximum number of shelves displayed in the product's cabling table cannot be exceeded.
- You cannot have more than four ES20s in a single set (maximum preference is three).
- You cannot have more than five ES30s in a single set (maximum preference is four).
- You can have a maximum of seven ES30s for systems with Extended Retention software.
- There are no specific placement or cabling requirements for the metadata shelves for DD Cloud Tier configurations. These shelves can be installed and cabled the same way as standard ES30 shelves.

**i** **NOTE:** An ES20 requires more power than an ES30. Ensure that your rack is configured to handle the power needs.

The tables below show how to configure a mixed system. To use the tables, go to the appropriate system. Then find the number of ES20s that are to be configured in the first column. The next column defines the number of ES20 sets. If there are multiple rows with the same number of ES20s then pick the row with the appropriate number of ES20 SATA shelves. The next column in that row defines the number of sets of ES30 SATA shelves. Finally, there may be entries for the number of desired ES30 SAS shelves and the number of sets to be used.

If the combinations of shelves exceed the supported usable storage, there may not be an entry. The entries are based on the smallest usable storage per shelf type (12TB for ES20, 12 TB for ES30 SATA, and 24TB for ES30 SAS). Always check that the sum of the usable storage of all of the shelves does not exceed the supported usable storage of the configuration.

**Table 102. Minimum and maximum configurations**

System	Minimum appliance shelf count	Maximum appliance shelf count	DD Cloud Tier systems in TB	Extended Retention systems (ER) in TB	Max shelves for ER
7200 (384)	3	20	<ul style="list-style-type: none"> <li>• 428</li> <li>• 240 for metadata</li> </ul>	<ul style="list-style-type: none"> <li>• DD OS 5.4 and earlier: 1728</li> <li>• DD OS 5.5 and later: 768</li> </ul>	56

Systems without Extended Retention or DD Cloud Tier all support four chains. The following tables show combinations of ES20 and ES30 shelves. For combinations of any two types of shelves, these tables can be used as a guide.

**Table 103. DD7200 cabling information**

DD7200					
ES20	ES20 chains	ES30 SATA	ES30 SATA chains	ES30 SAS	ES30 SAS chains

**Table 103. DD7200 cabling information (continued)**

DD7200					
13-16	4	0	0	0	0
9-12	3	1-5	1	0	0
9-12	3	0	0	1-5	1
5-8	2	1-5	1	1-5	1
5-8	2	6-8	2	0	0
5-8	2	0	0	1-5	1
5-8	2	0	0	6-10	2
1-4	1	11-15	3	0	0
1-4	1	6-10	2	1-5	1
1-4	1	1-5	1	1-5	1
1-4	1	1-5	1	6-10	2
1-4	1	0	0	1-5	1
1-4	1	0	0	6-10	2
1-4	1	0	0	11-15	3
0	0	16-20	4	0	0
0	0	11-15	3	1-5	1
0	0	6-10	2	1-5	1
0	0	6-10	2	6-10	2
0	0	1-5	1	1-5	1
0	0	1-5	1	6-10	2
0	0	1-5	1	11-15	3
0	0	0	0	1-4	1
0	0	0	0	5-8	2
0	0	0	0	9-12	3
0	0	0	0	13-16/18	4

The following figures show cabling for base systems, systems with the Extended Retention software option, and systems integrated with an Avamar system.

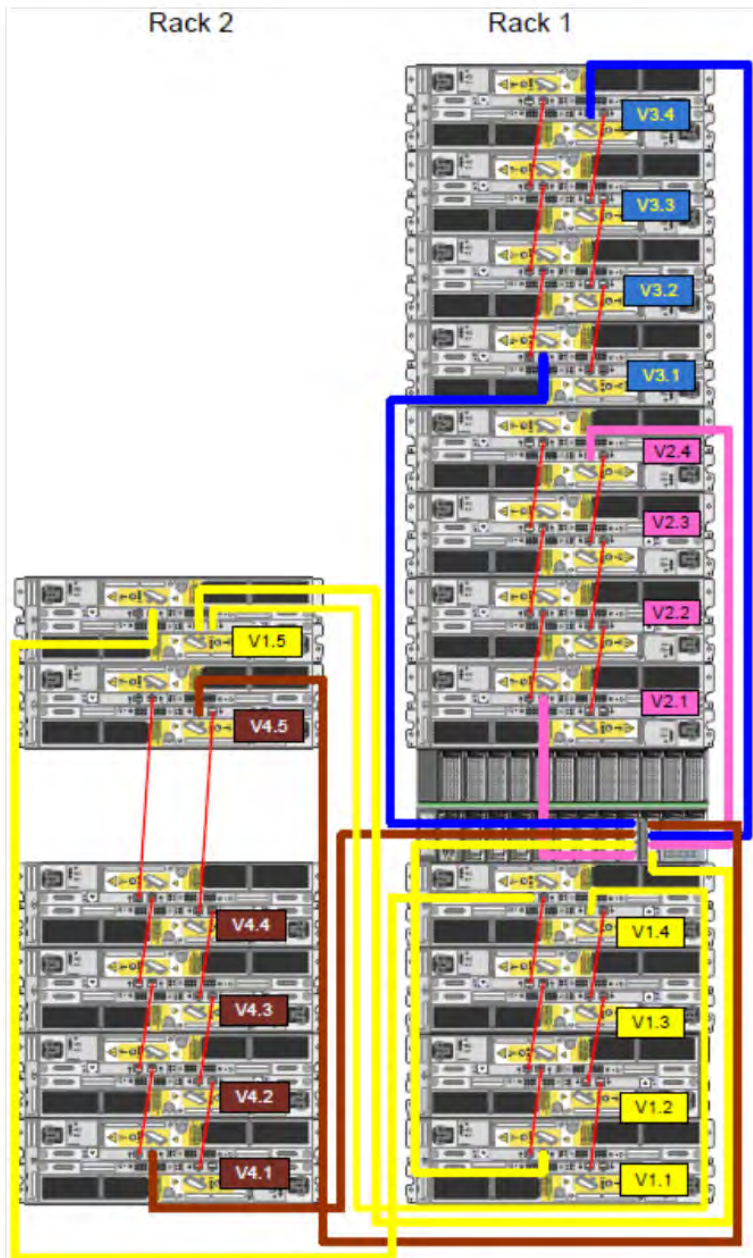


Figure 95. Recommended DD7200 cabling





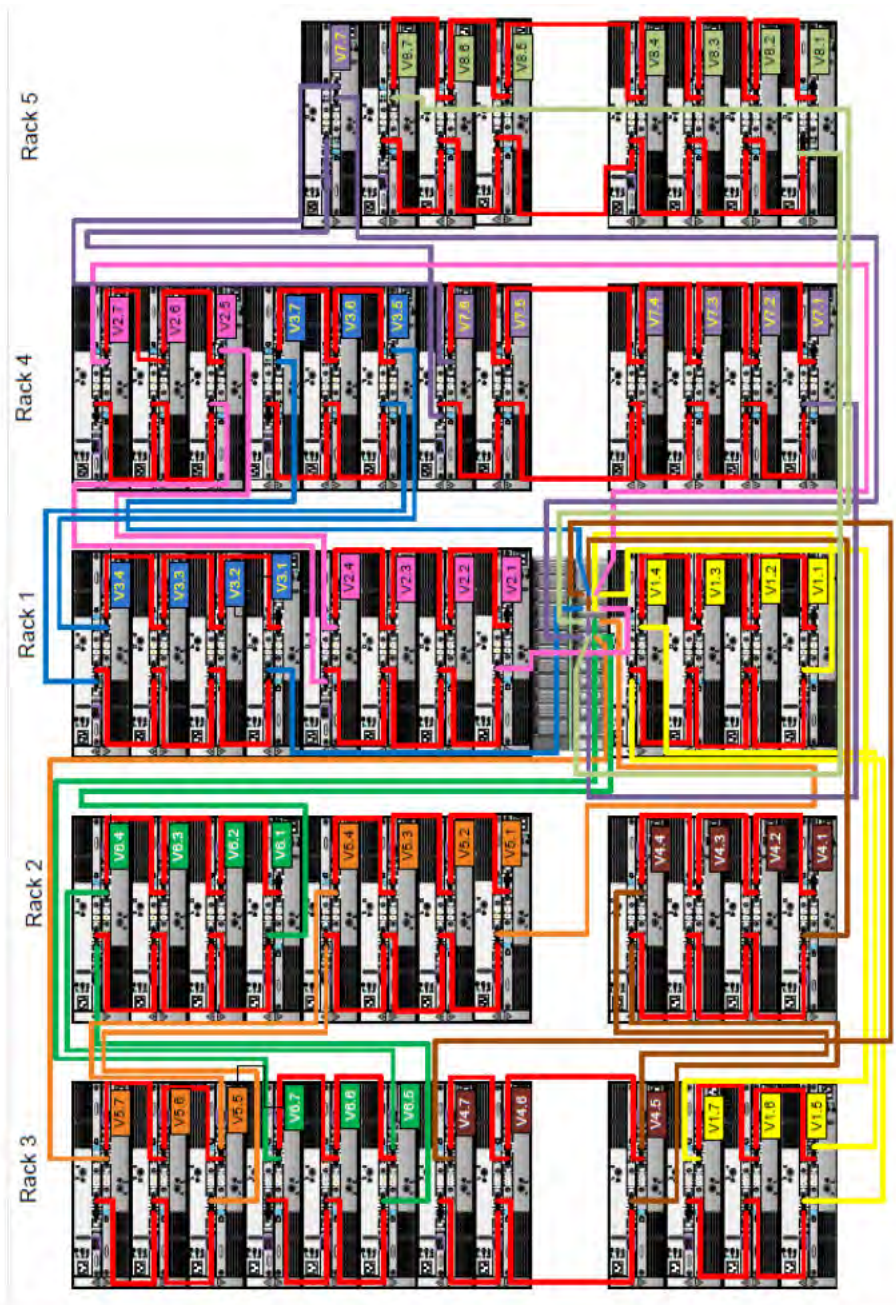


Figure 97. Recommended cabling for DD7200 with extended retention software or DD Cloud Tier

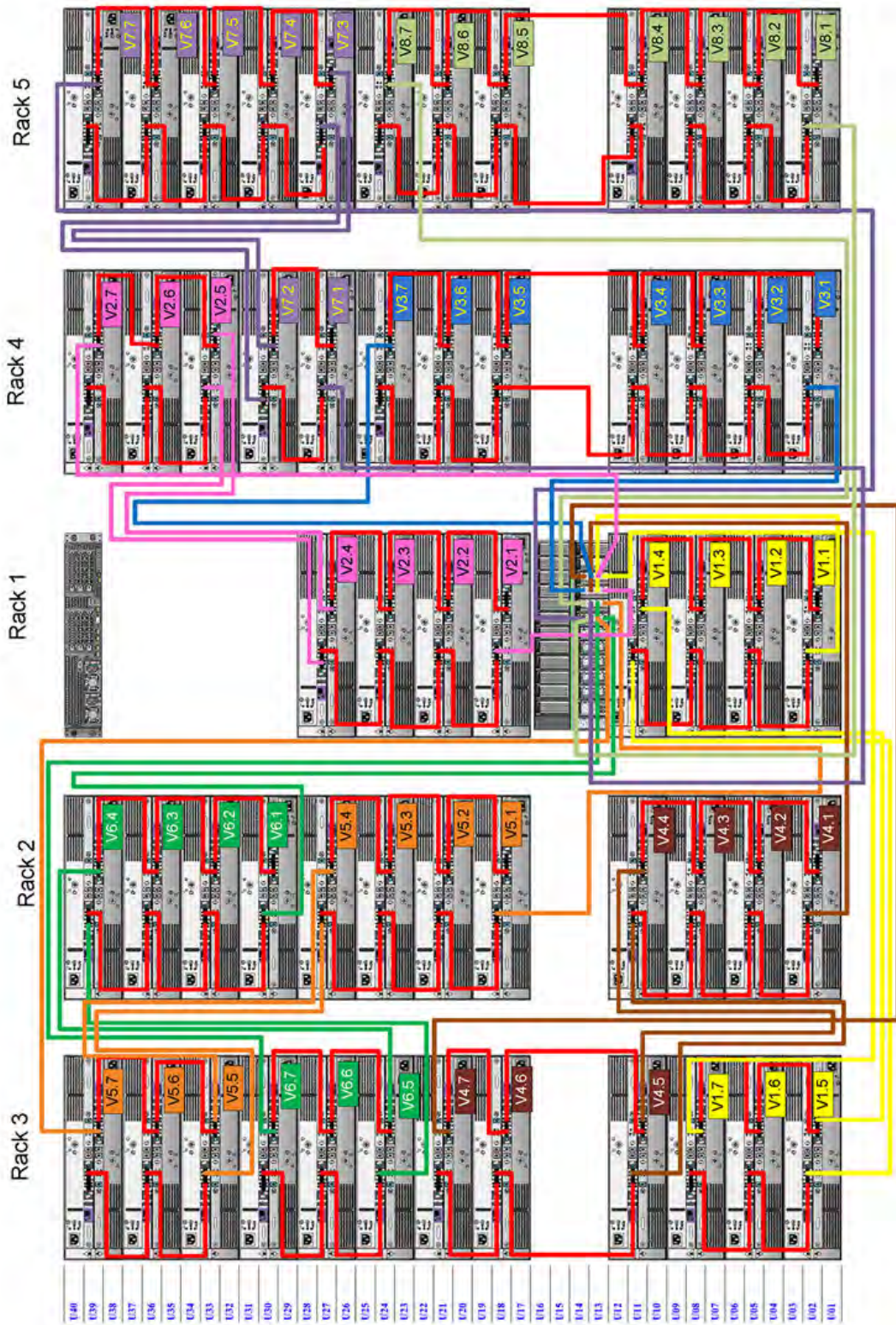


Figure 98. Recommended cabling for DD7200 with extended retention and integrated with Avamar



## DD7200 and DS60 shelf guidelines

The Data Domain system rediscovers newly configured shelves after it restarts. You can power off the system and recable shelves to any other position in a set, or to another set. To take advantage of this flexibility, you need to follow these rules before making any cabling changes:

- Do not exceed the maximum shelf configuration values for your Data Domain system as listed in the following table.
- For redundancy, the two connections from a Data Domain system to a set of shelves must use ports on different SAS I/O modules.
- Use the Installation and Setup Guide for your Data Domain system to minimize the chance of a cabling mistake.
- A Data Domain system cannot exceed its maximum raw external shelf capacity, regardless of added shelf capacity.
- ES30 SATA shelves must be on their own chain.
- If ES30 SAS shelves are on the same chain as a DS60, the maximum number of shelves on that chain is 5.
- DD OS 5.7.1 does not support HA with SATA drives.

**Table 104. DD7200 and DS60 shelf configuration**

DD system	Memory required (GB)	SAS cards/port per card	DS60 support (TB)	Max shelves per set	Max number of sets	Max external capacity available (TB) <sup>1</sup>	Max RAW external capacity (TB)
DD7200	128	2x4	SAS 45	2	4	288	360
DD7200	256	2x4	SAS 45, 60	2	4	432	540
DD7200 ER <sup>2</sup>	256	4x4	SAS 45, 60	2	8	864	1080

**NOTE:** An entry of 45 corresponds to DS60-3 models and an entry of 60 corresponds to DS60-4 models.

1. This column only counts drives that have user data in the shelves. For example, a DS60 4-240 has 192TB.

2. With Extended Retention software.

## Single phase power connections for 40U-P (current racks)

The following figures show single phase power connections for several Data Domain systems.



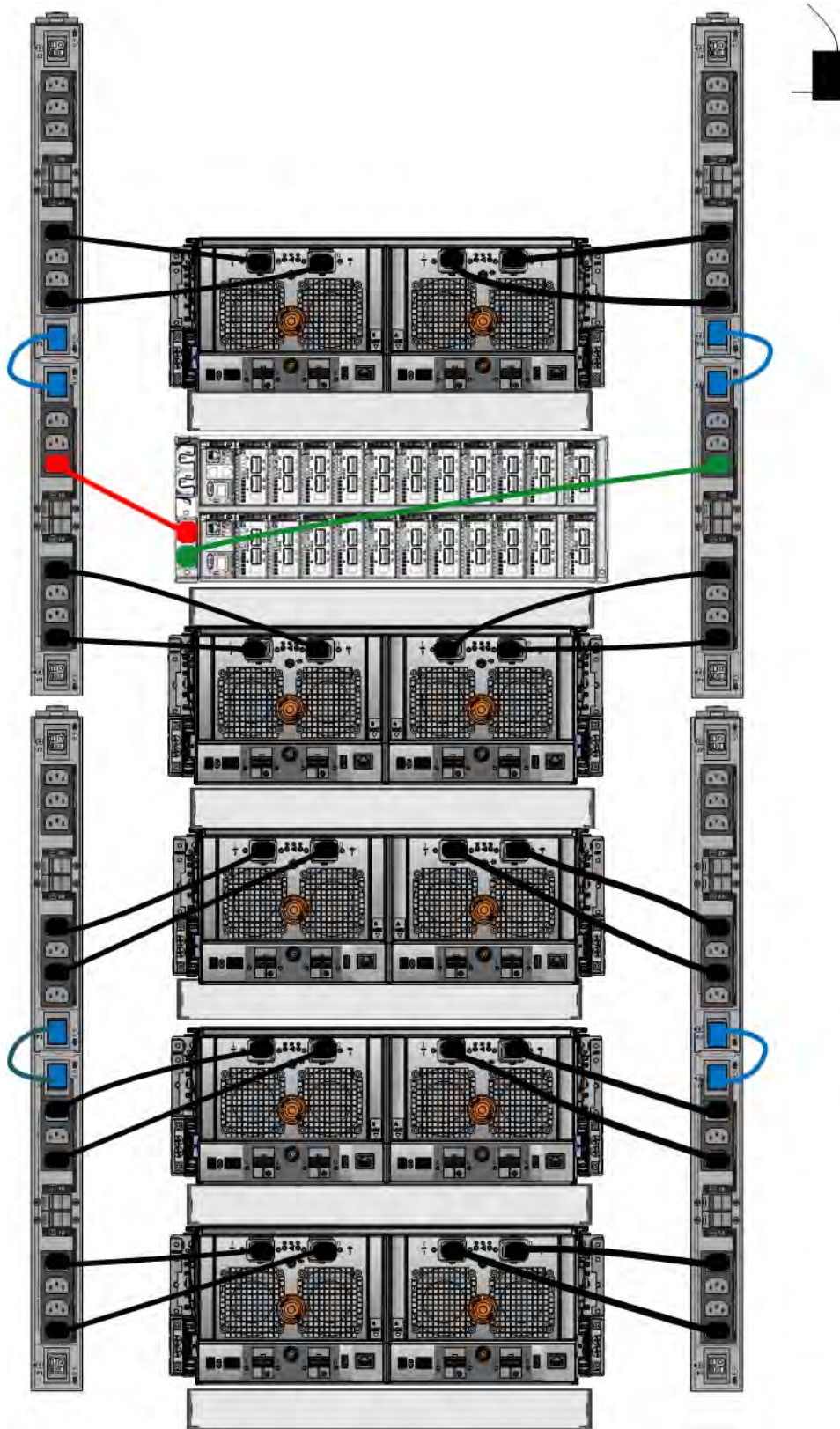


Figure 99. Single phase power connections for DD4200, DD4500, and DD7200 systems

### 3-phase power connections for 40U-P (current racks)

Some environments use 3-phase power for 40U-P racks used for several Data Domain systems. In those situations it is desirable to balance the current draw across all 3 phases. The recommended 3-phase power cabling attempts to do that, but an optimal

configuration is dependent on the specific installation. The following figures show recommended 3-phase power connections for several Data Domain systems.

**NOTE:** The next few diagrams show recommended 3-phase delta power connections.

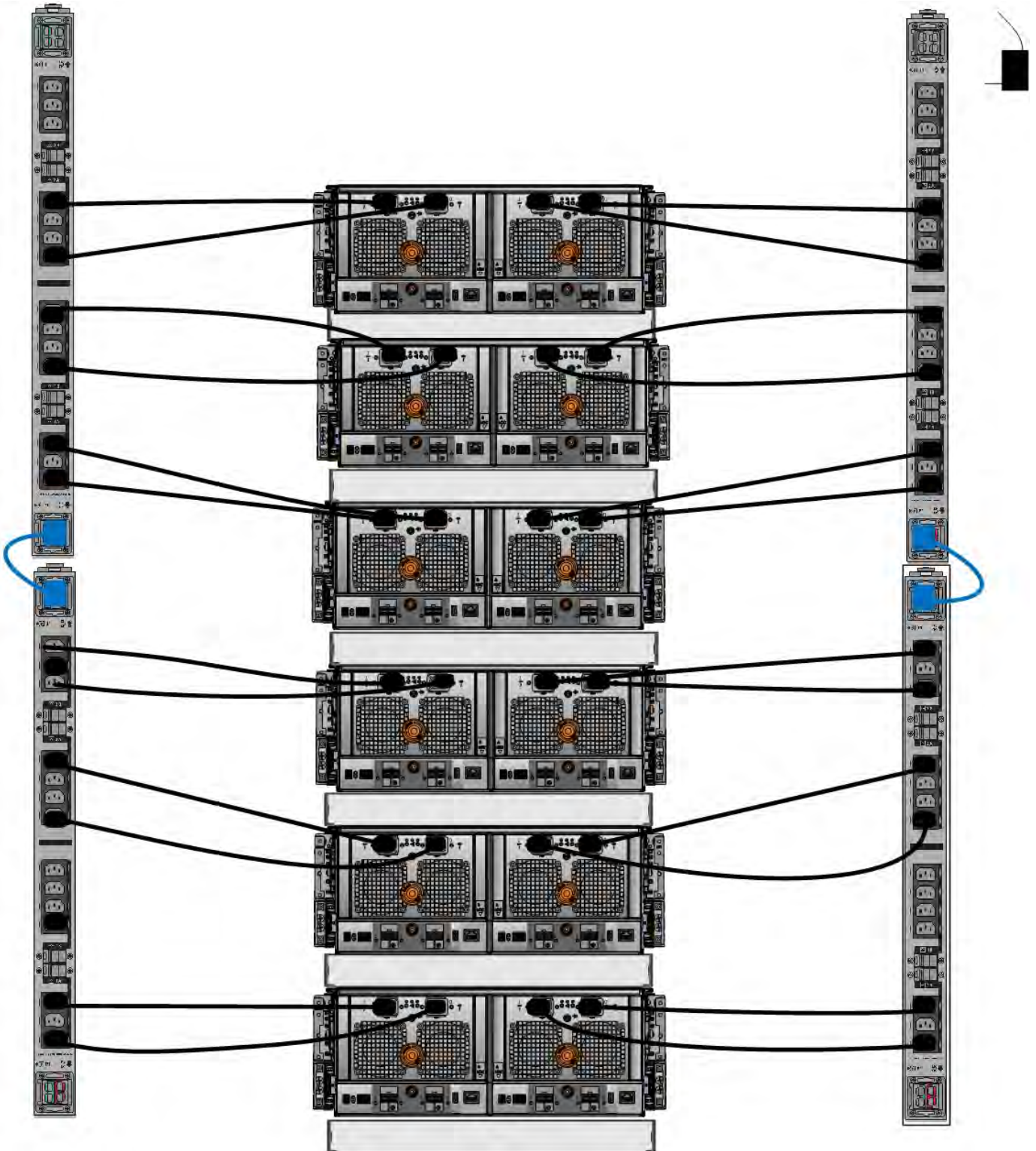


Figure 100. 3-phase delta power connections for DS60 expansion shelves (full-racked)



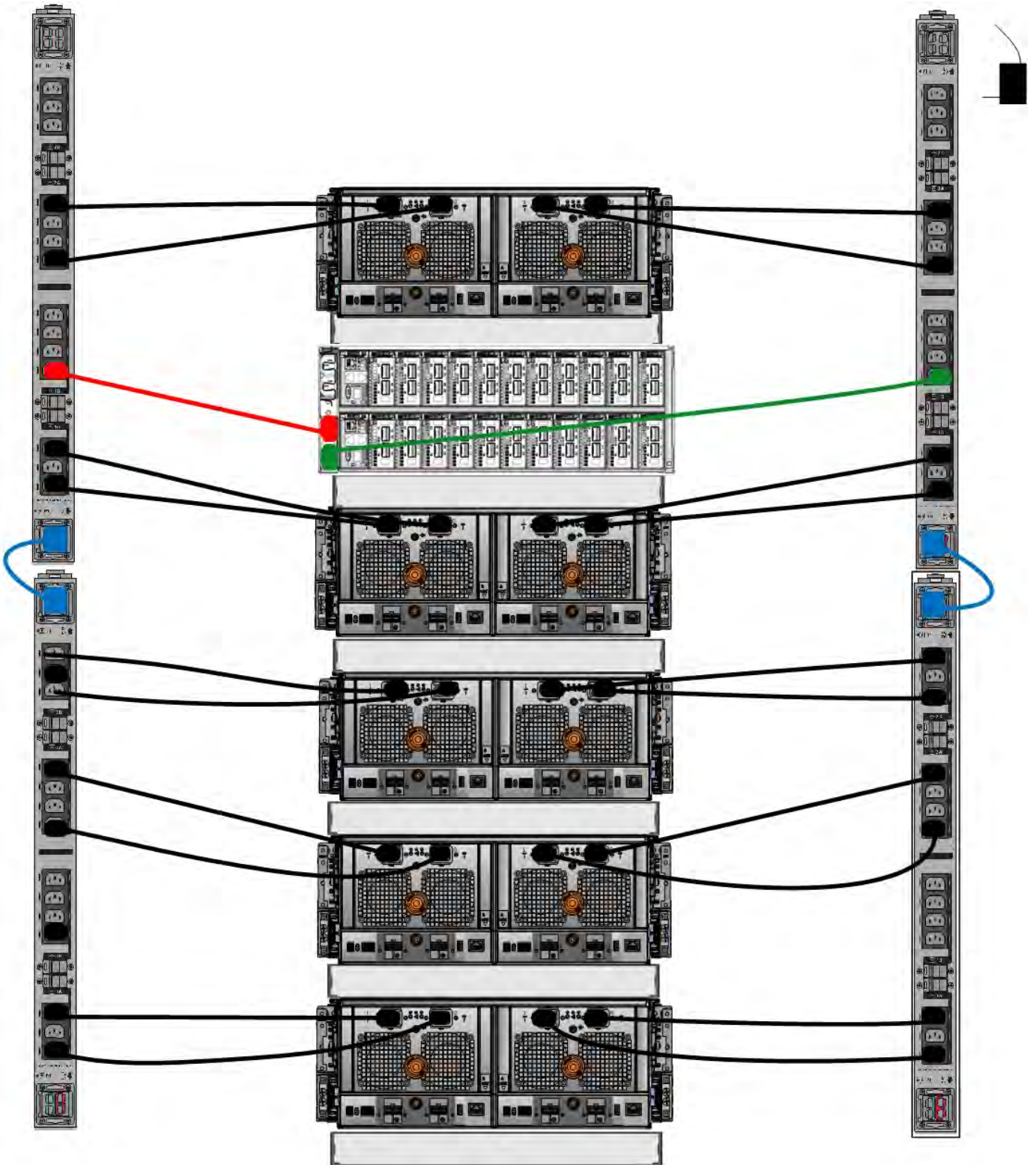


Figure 101. 3-phase delta power connections for DD4200, DD4500, and DD7200 systems

**NOTE:** The next few diagrams show recommended 3-phase wye power connections.

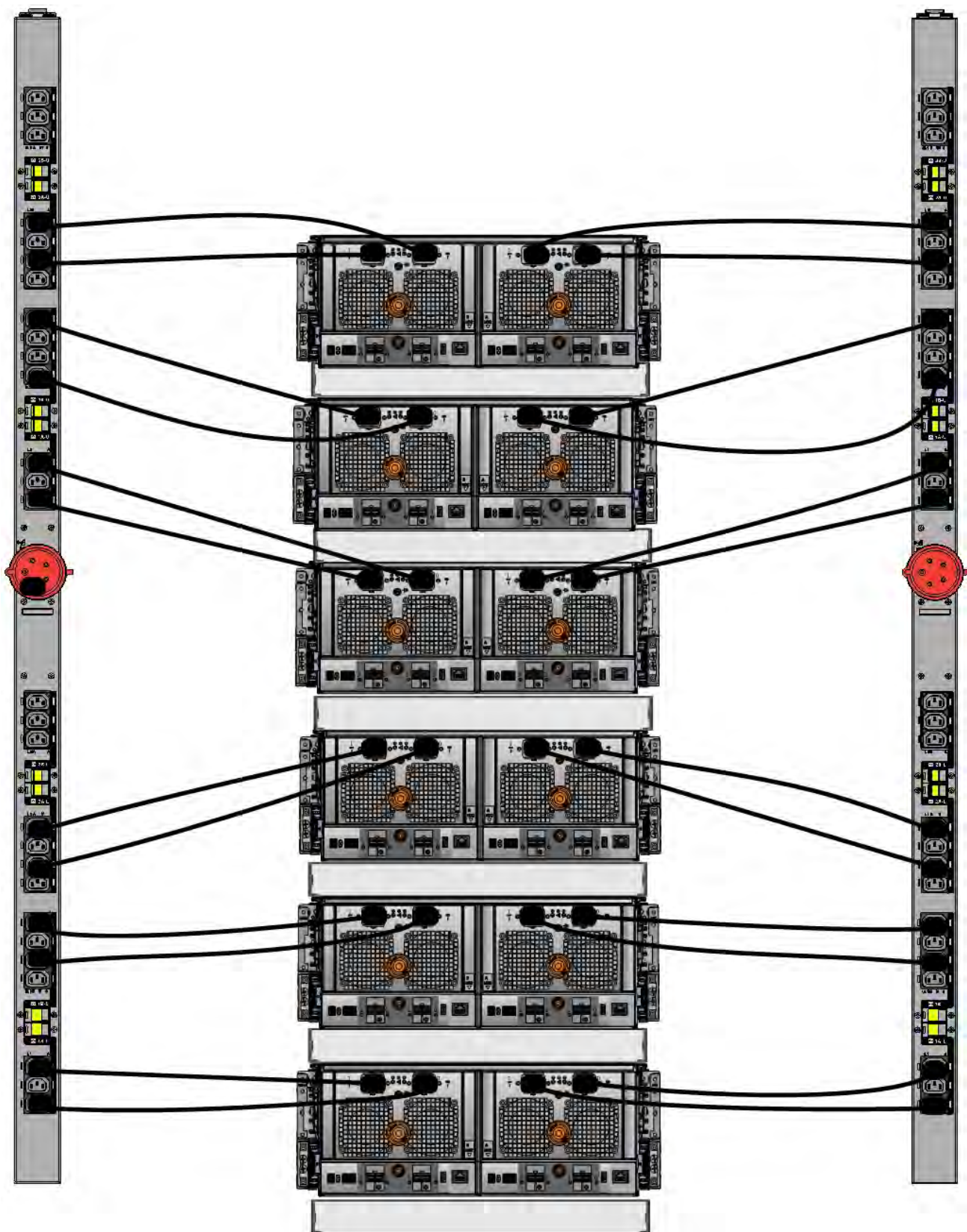


Figure 102. 3-phase wye power connections for DS60 expansion shelves (full-racked)



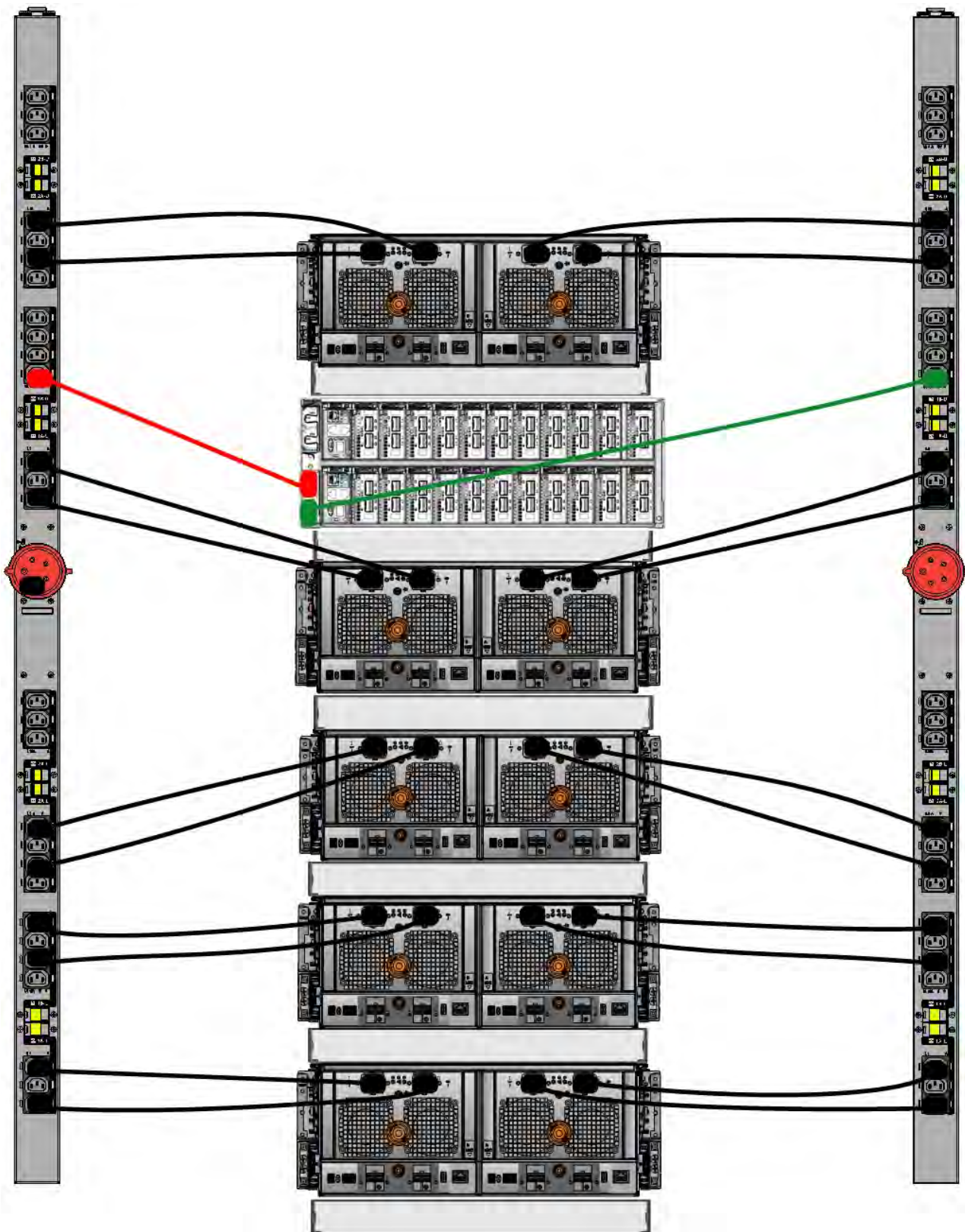


Figure 103. 3-phase wye power connections for DD4200, DD4500, and DD7200 systems

## DS60 and DD7200 cabling

There are a few rules that must be followed when adding a mixture of DS60 and other shelf types to your system.

 **CAUTION:** If a system does not follow all these rules, it is not a legitimate configuration.

Prerequisites:

- You cannot exceed the maximum amount of usable capacity displayed in cabling table for each system.
- You cannot exceed the maximum number of shelves displayed in cabling table for each system.
- You cannot connect more than two DS60 shelves in a single set.

**Table 105. Minimum and maximum configurations**


System	Appliance maximum	Minimum appliance shelf count
DD7200	384 TB	1

Mixing DS60, ES30, and ES20 shelves:


The non-Extended Retention versions of these systems all support four chains.

Extra planning and reconfiguration may be required to add DS60 shelves to system with ES20 shelves, ES30 SATA shelves, or a combination of shelves.

- The ES20 shelves must be on their own set. Minimize the ES20 set count by combining up to four ES20s per set.
- ES30 SATA shelves must also be on their own sets. Minimize the ES30 set count by combining up to five ES30s per set. If required, combine up to seven ES30 SAS shelves per set to minimize the set count.
- A set can contain a maximum of two DS60 shelves and, if required because of other restrictions, add ES30 SAS shelves up to a maximum of five shelves in that set.

 **NOTE:** The configuration rules apply also to Extended Retention systems.

The following figures show cabling for base systems and systems with the Extended Retention software.

 **NOTE:** It is recommended that the DS60 shelf with the greater number of drives should always be placed in the bottom position.

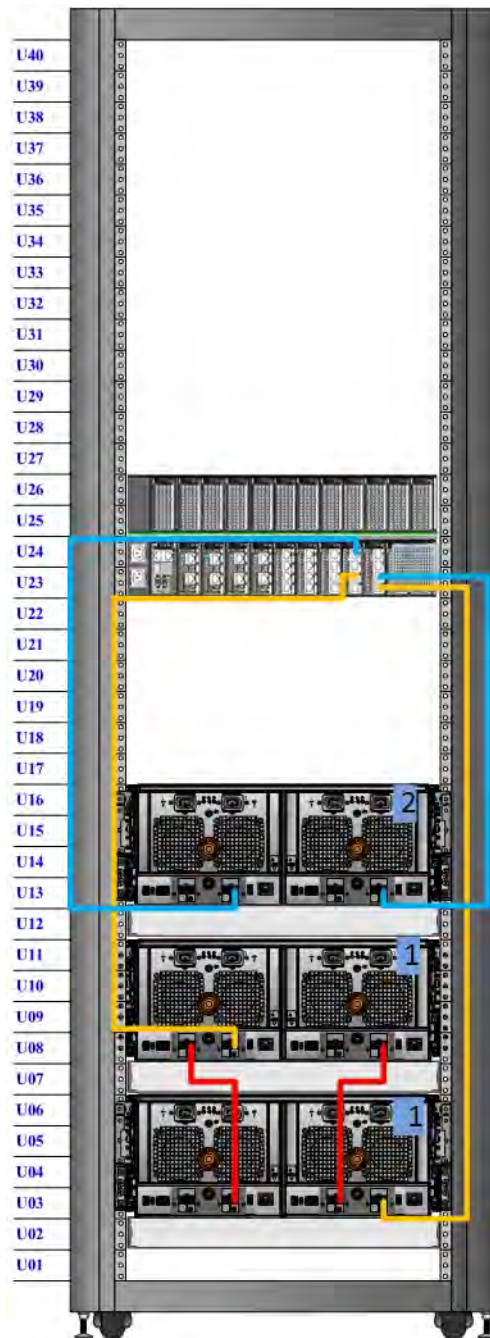


Figure 104. Recommended cabling for DD7200 (3TB drives)



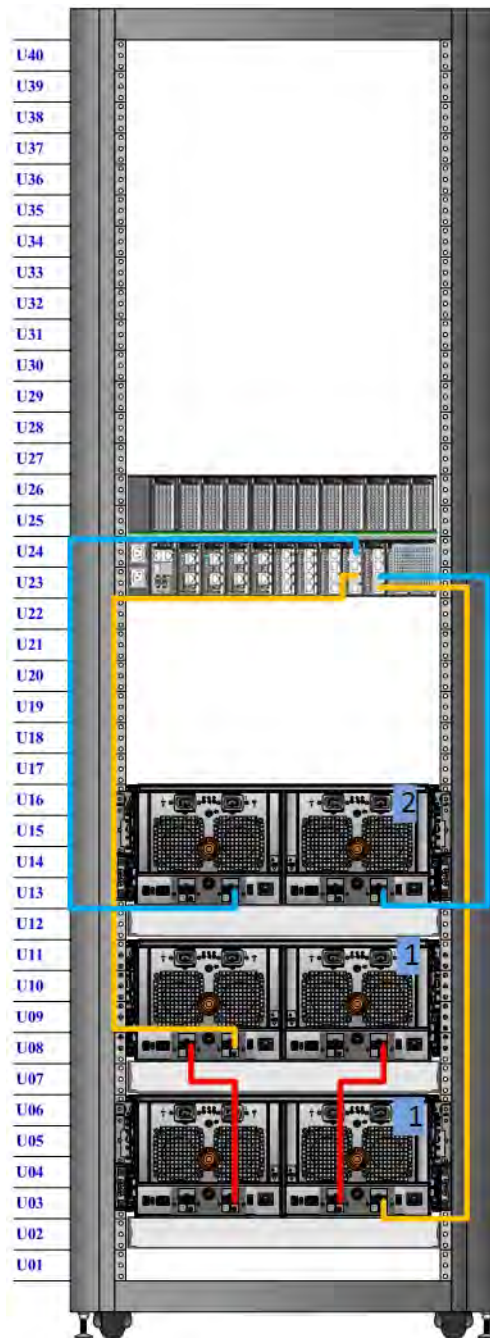


Figure 105. Recommended cabling for DD7200 (4TB drives)

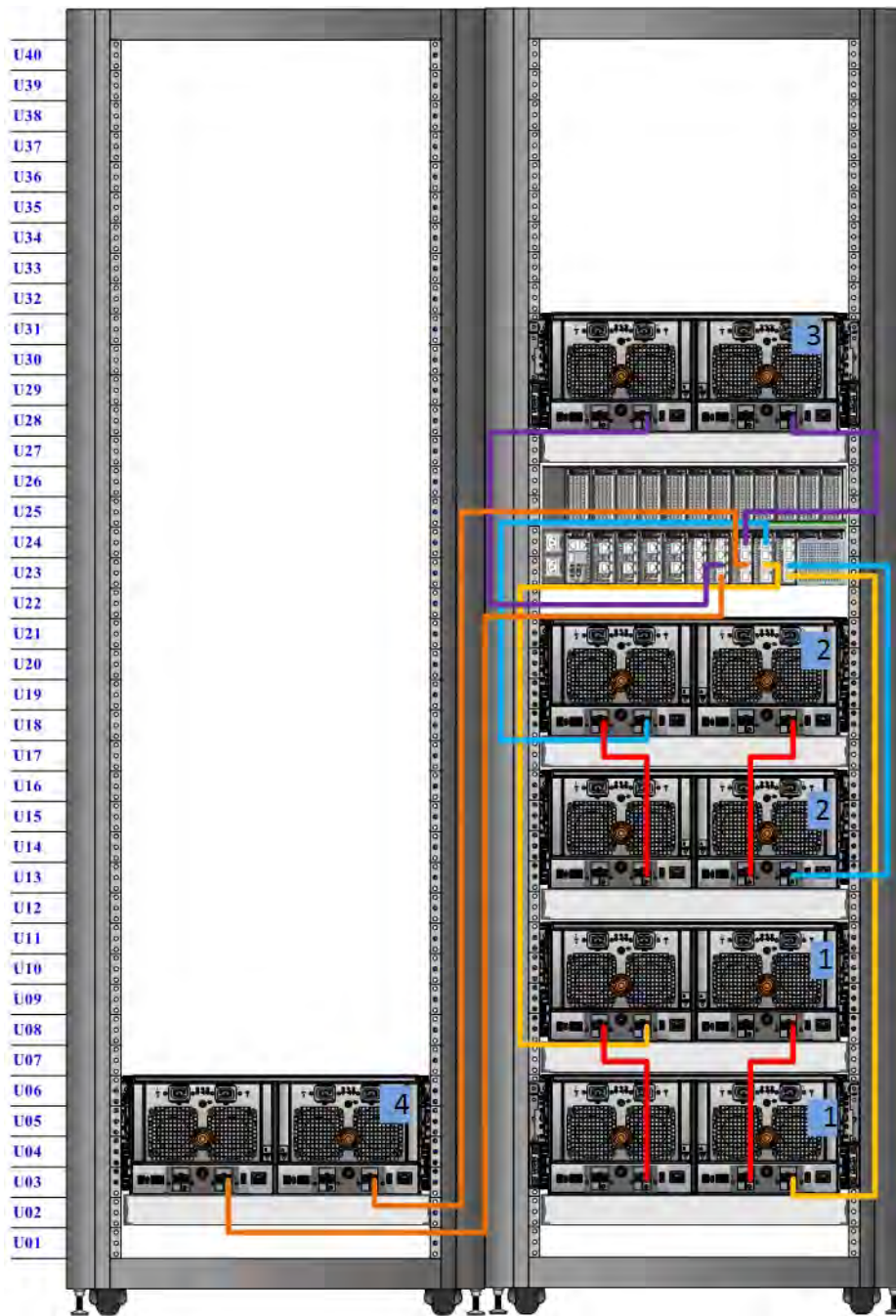


Figure 106. Recommended cabling for DD7200 (3TB drives) with Extended Retention software

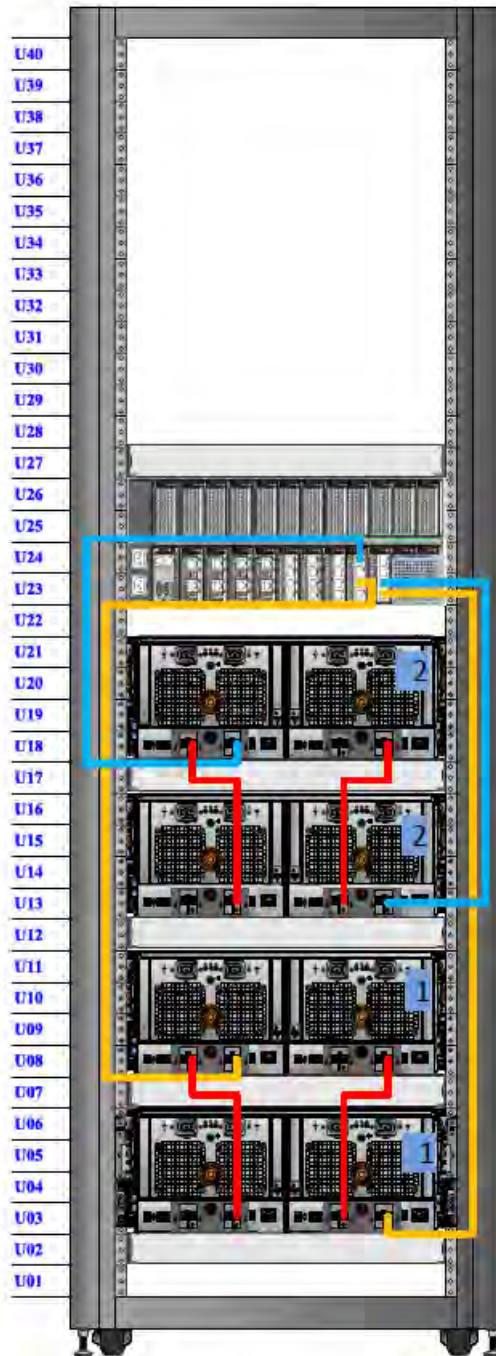


Figure 107. Recommended cabling for DD7200 with DD Cloud Tier

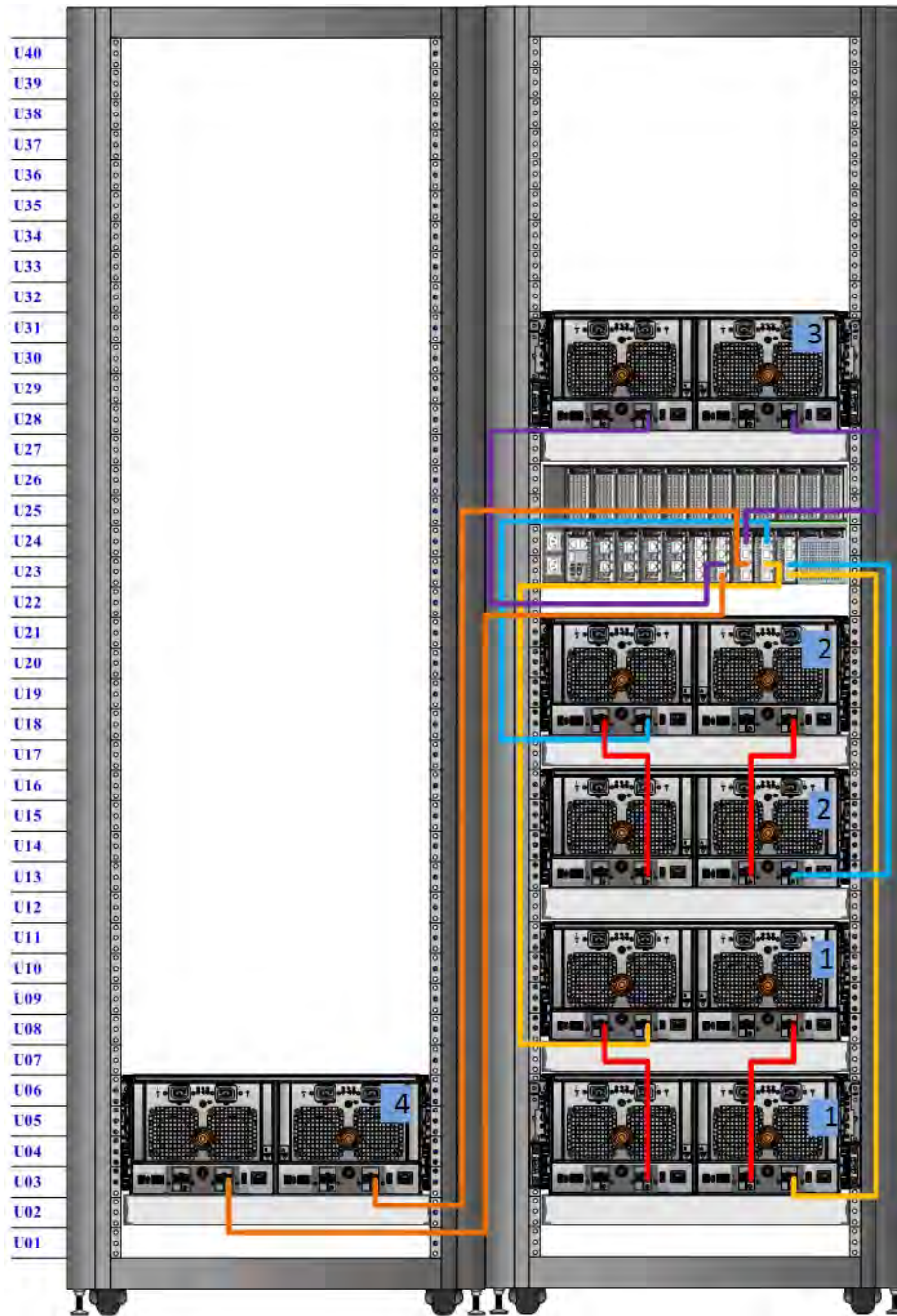


Figure 108. Recommended cabling for DD7200 (4TB drives) with Extended Retention software



# DD9300

This chapter contains the following topics:

## Topics:

- [system features](#)
- [system specifications](#)
- [DD9300 storage capacity](#)
- [DD9300 front panel](#)
- [Back panel](#)
- [I/O modules](#)
- [Internal system components](#)
- [DD9300 and ES30 shelf guidelines](#)
- [DD9300 and DS60 shelf guidelines](#)

## system features

**Table 106. system features**

Feature		(Base configuration)	(Expanded configuration)
Rack height		2U	2U
Processor		E5-2680 V3	E5-2680 V3
Kernel		3.2.x	3.2.x
NVRAM		NVRAM 8g Model 3	NVRAM 8g Model 3
Memory		4 x 32 GB DIMM + 4 x 16 GB DIMM (192 GB)	8 x 32 GB DIMM + 8 x 16 GB DIMM (384 GB)
Internal drives	HDDs in 3.5" bays	4	4
	SSDs in 3.5" bays	5	8
	SSDs in 2.5" bays	0	0
I/O module slots	SAS I/O modules (Quad Port 6 Gbps SAS)	2	2
	Network and FC I/O modules	Four replaceable I/O module slots. Not hot-swappable.	Four replaceable I/O module slots. Not hot-swappable.
Supported capacity	Non-extended retention	384 TB	720 TB
	DD Cloud Tier	N/A	1440 TB <sup>a</sup>
	Extended retention	N/A	720 TB <sup>b</sup>
High availability support		Yes	Yes
HA private interconnect		(2) 10GBase-T ports	(2) 10GBase-T ports
External SSD shelf		One SSD shelf for A-P high availability cluster containing two drives.	One SSD shelf for A-P high availability cluster containing four drives.

**Table 106. system features (continued)**

Feature		(Base configuration)	(Expanded configuration)
SAS string depth (max)	ES30	6	6 (7 for extended retention)
	DS60	3	3
	ES30 and DS60	5 shelves total	5 shelves total
Stream count		810 writes, 225 reads	810 writes, 225 reads

- a. DD Cloud Tier requires four ES30 shelves fully populated with 4 TB drives to store DD Cloud Tier metadata.
- b. Extended retention not available on HA configurations

## system specifications

**Table 107. system specifications**

Model	Average power consumption 25 C	Heat dissipation (operating maximum)	Weight <sup>a</sup>	Width	Depth	Height
	645W	1.69 x 10 <sup>6</sup> J/hr (1604 Btu/hr) maximum	70 lbs (31.75 kg)	17.50 in (44.45 cm)	30.5 in (77.5 cm)	3.40 in (8.64 cm)

- a. The weight does not include mounting rails. Allow 2.3-4.5 kg (5-10 lb) for a rail set.

**Table 108. System operating environment**

Requirement	Description
Ambient temperature	10°C - 35°C; derate 1.1°C per 1,000 ft (304 m)
Relative humidity (extremes)	20–80% noncondensing
Elevation	0 - 7,500ft (0 - 2,268m)
Operating acoustic noise	L <sub>wad</sub> sound power, 7.5 Bels

## DD9300 storage capacity

The following table provides storage capacity information for the DD9300 system.

**Table 109. DD9300 storage capacity**

Memory	Internal disks (system disks only)	External storage (raw)	Usable data storage space (TB/TiB/GB/GiB) <sup>a</sup>			
192 GB (Base)	<ul style="list-style-type: none"> <li>• 4 x 4 TB HDD</li> <li>• 5 x 800 GB SSD</li> </ul>	480 TB <sup>b</sup>	384 TB	349.2 TiB	384,000 GB	357,628 GiB
384 GB (Expanded)	<ul style="list-style-type: none"> <li>• 4 x 4 TB HDD</li> <li>• 8 x 800 GB SSD</li> </ul>	<ul style="list-style-type: none"> <li>• Active Tier: 900 TB<sup>b</sup></li> <li>• Archive Tier: 900 TB<sup>c</sup></li> <li>• Cloud Tier: 1800 TB in the cloud<sup>d</sup></li> </ul>	<ul style="list-style-type: none"> <li>• Active Tier: 720 TB</li> <li>• Archive Tier: 720 TB</li> <li>• Cloud Tier: 1,440 TB</li> </ul>	<ul style="list-style-type: none"> <li>• Active Tier: 654.8 TiB</li> <li>• Archive Tier: 654.8 TiB</li> <li>• Cloud Tier: 1,309.6 TiB</li> </ul>	<ul style="list-style-type: none"> <li>• Active Tier: 720,000 GB</li> <li>• Archive Tier: 720,000 GB</li> <li>• Cloud Tier: 144,000 GB</li> </ul>	<ul style="list-style-type: none"> <li>• Active Tier: 670,552 GiB</li> <li>• Archive Tier: 670,552 GiB</li> <li>• Cloud Tier: 1,341,104 GiB</li> </ul>



**Table 109. DD9300 storage capacity (continued)**

Memory	Internal disks (system disks only)	External storage (raw)	Usable data storage space (TB/TiB/GB/GiB) <sup>a</sup>			
		<ul style="list-style-type: none"> <li>Cloud Tier metadata: 240 TB local storage</li> </ul>	<ul style="list-style-type: none"> <li>Cloud Tier metadata: 192 TB</li> </ul>	<ul style="list-style-type: none"> <li>Cloud Tier metadata: 174.6 TiB</li> </ul>	<ul style="list-style-type: none"> <li>Cloud Tier metadata: 192,000 GB</li> </ul>	<ul style="list-style-type: none"> <li>Cloud Tier metadata: 178,814 GiB</li> </ul>

- a. The capacity differs depending on the size of the external storage shelves used. This data based on ES30 shelves.
- b. HA is supported.
- c. HA is not supported with Extended Retention.
- d. HA is supported in combination with Cloud Tier.

## DD9300 front panel

DD9300 Dataless Head (DLH) systems have one of the following front panel drive configurations to host the DD OS boot drives and provide metadata caching on SSD:

**Table 110. DD9300 DLH SSD requirements**

Configuration	Number of SSDs
DD9300	5
DD9300 expanded	8

**NOTE:** SSDs are not RAID-protected.

**Table 111. DD9300 DLH configuration drive layout**

Slot 0: HDD 1	Slot 1: HDD 2	Slot 2: HDD 3	Slot 3: HDD 4
Slot 4: SSD 1	Slot 5: SSD 2	Slot 6: SSD 3	Slot 7: SSD 4
Slot 8: SSD 5	Slot 9: Filler	Slot 10: Filler	Slot 11: Filler

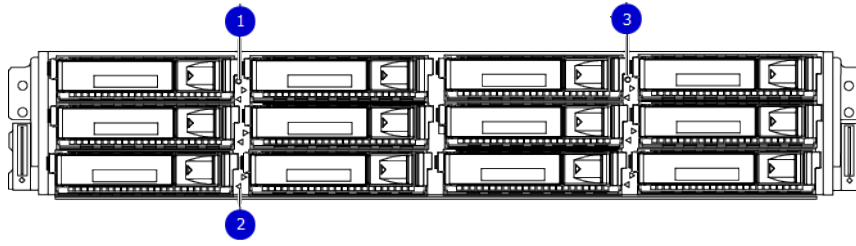
**Table 112. DD9300 DLH expanded configuration drive layout**

Slot 0: HDD 1	Slot 1: HDD 2	Slot 2: HDD 3	Slot 3: HDD 4
Slot 4: SSD 1	Slot 5: SSD 2	Slot 6: SSD 3	Slot 7: SSD 4
Slot 8: SSD 5	Slot 9: SSD 6	Slot 10: SSD 7	Slot 11: SSD 8

## Front LED indicators

The front of the system contain 12 disk drive status LEDs that are normally blue, and blink when there is activity on the disk. The LEDs are shaped like triangles, and the apex of the triangle points left or right, indicating that disk's status. If the disk drive has a failure, the disk's status LED turns from blue to amber, indicating that a drive must be replaced.

The front also contains two system status LEDs. A blue system power LED is present that is on whenever the system has power. An amber system fault LED is also present that is normally off and lit amber whenever the chassis or any other FRU in the system requires service.



**Figure 109. Front LED indicators**

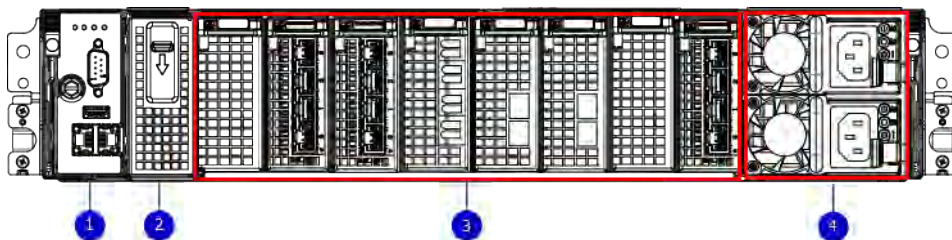
1. System service LED
2. Drive activity/service LED
3. System power LED

**Table 113. Front LEDs**

Name	Color	Purpose
System power LED	Blue	Indication that the system has power.
System service LED	Amber	Normally off; is lit amber whenever the SP or any other FRU (except disk drives) in the system requires service.
Drive activity/Service LED	Blue /Amber	<ul style="list-style-type: none"> <li>• Lit blue when the drive is powered.</li> <li>• Blinks blue during drive activity.</li> <li>• Lit solid amber when a disk needs service.</li> </ul>

## Back panel

The back panel of the chassis contains the following components:



1. Management panel
2. Not Used -- Two 2.5" SSD slots labeled 0 and 1
3. I/O module slots
4. Power supply modules (PSU 0 is the lower module, and PSU 1 is the upper module)

## Rear LED indicators

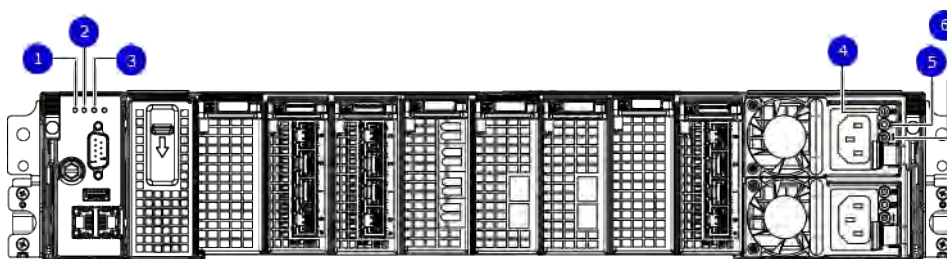


Figure 110. Rear LED indicators

1. Do not remove LED
2. SP service LED
3. System power LED
4. AC power good LED
5. DC power good LED
6. Power supply fault LED

Name of LED	Location	Color	Definition
"Do not remove" LED	Upper left-most part of rear chassis	White	This LED is lit during system BIOS and BMC firmware updates and indicates that the SP should not be removed from the chassis, nor should system power be removed.
SP service LED	To the right of "Do not remove" LED	Amber	<ul style="list-style-type: none"> <li>• Solid amber - SP or a FRU inside the SP requires service</li> <li>• Blinking amber - blink rate reflects one of the following is booting                             <ul style="list-style-type: none"> <li>○ BIOS - 1/4 Hz</li> <li>○ POST - 1 Hz</li> <li>○ OS - 4 Hz</li> </ul> </li> </ul>
Drive Power/Activity LED <sup>a</sup>	Left LED on the SSD	Blue	Lit blue when the drive is powered. Blinks during drive activity.

Name of LED	Location	Color	Definition
Drive Fault LED <sup>a</sup>	Right LED on the SSD	Amber	Lit solid amber when a drive needs service.
System power LED	Right-most LED on the management panel	Blue	SP has good, stable power
PSU FRU LED - AC Good	Top LED on power supply	Green	AC input is as expected
PSU FRU LED - DC Good	Middle LED on power supply	Green	DC output is as expected
PSU FRU LED - Attention	Bottom LED on power supply	Amber	PSU has encountered a fault condition

a. The SSD is only present on DD6300 systems.

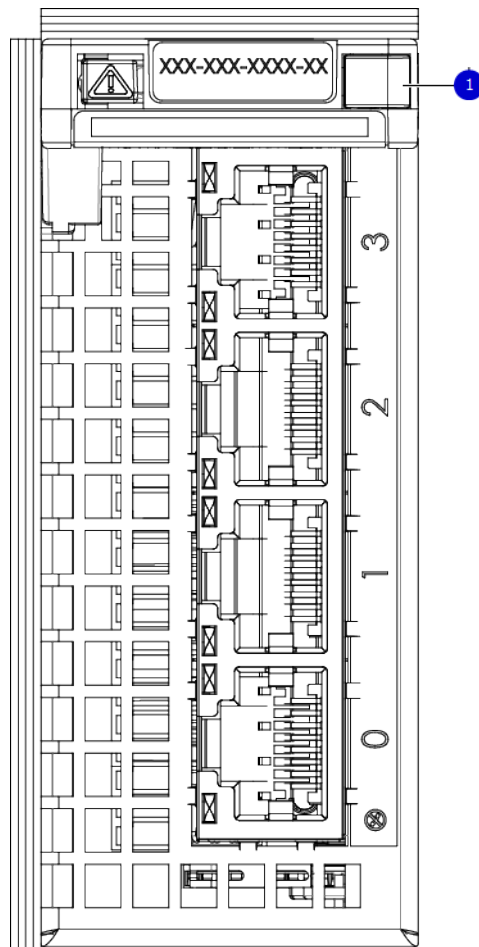


Figure 111. I/O module Power/Service LED location

1. I/O module power/service LED

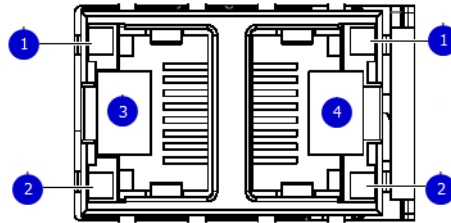
Table 114. I/O LEDs

Name of LED	Location	Color	Definition
I/O module FRU LED - I/O module Power/Service LED location on page 188	Ejector handle of I/O modules	Green/Amber	<ul style="list-style-type: none"> <li>Green - I/O module has power and is functioning normally</li> <li>Amber - I/O module has encountered a fault condition and requires service</li> </ul>

**Table 114. I/O LEDs (continued)**

Name of LED	Location	Color	Definition
I/O port status LED (SAS, Fibre Channel, and optical networking I/O modules only)	One LED per I/O module port	Blue	Lit when port is enabled. May flash if SW "marks" the port. <sup>a</sup>

a. For RJ45 networking ports, the standard green link and amber activity LEDs are used.



**Figure 112. Onboard network port LEDs**

1. Network port link LED
2. Network port activity LED
3. Dedicated IPMI port BMC0A
4. Management interface EthMa

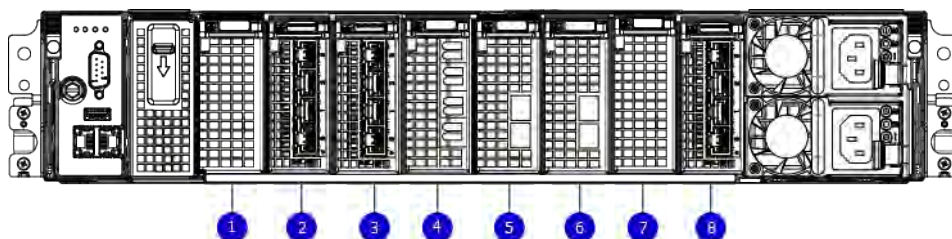
**Table 115. Onboard network port LEDs**

Name of LED	Location	Color	Definition
Onboard network port LED - Link LED <a href="#">Onboard network port LEDs</a> on page 189	Top LED on network port	Green	<ul style="list-style-type: none"> <li>• Lit when there is a link at 1000BaseT and 100BaseT speeds</li> <li>• Off when the link speed is 10BaseT or there is no link</li> </ul>
Onboard network port LED - Activity LED	Bottom LED on network port	Amber	Blinks when there is traffic on the port

## I/O modules

### I/O module slot numbering

The eight I/O module slots are enumerated as Slot 0 (on the left when viewed from the rear) through Slot 7. Ports on an I/O module are enumerated as 0 through 3, with 0 being on the bottom.



**Figure 113. I/O module slot numbering**

1. Slot 0
2. Slot 1
3. Slot 2

4. Slot 3
5. Slot 4
6. Slot 5
7. Slot 6
8. Slot 7

I/O modules are only supported in fixed configurations. The fixed configurations define the exact slots into which the I/O modules may be inserted. The processors directly drive the eight I/O module slots, meaning all slots are full performance.

The non-optional SAS, NVRAM, and 10GBaseT I/O modules are allocated to fixed slots. The optional Host Interface I/O modules are used for front end networking and Fibre Channel connections. The quantity and type of these I/O modules is customizable, and there are many valid configurations.

## slot map

I/O module slots 3–6 contain optional Host Interface I/O modules and can contain specific I/O modules or no I/O modules at all. Slot 0, Slot 1, Slot 2, and Slot 7 are populated with the required I/O modules and are not optional.

**Table 116. I/O module slot mapping**

Tier	Slot 0	Slot 1	Slot 2	Slot 3	Slot 4	Slot 5	Slot 6	Slot 7
DLH DLH Extended Retention/DD Cloud Tier	NVRAM 8g Model 3	Quad Port 10 GBase-T	Quad Port 6 Gbps SAS	Quad Port 10GbE SR, Quad Port 10 GBase-T, or Dual Port 16 Gbps Fibre Channel	Quad Port 10GbE SR, Quad Port 10 GBase-T, or Dual Port 16 Gbps Fibre Channel	Quad Port 10GbE SR, Quad Port 10 GBase-T, or Dual Port 16 Gbps Fibre Channel	Quad Port 10GbE SR, Quad Port 10 GBase-T, or Dual Port 16 Gbps Fibre Channel	Quad Port 6 Gbps SAS
DLH High Availability	NVRAM 8g Model 3	Quad Port 10 GBase-T for HA interconnect	Quad Port 6 Gbps SAS	Quad Port 10GbE SR, Quad Port 10 GBase-T, or Dual Port 16 Gbps Fibre Channel	Quad Port 10GbE SR, Quad Port 10 GBase-T, or Dual Port 16 Gbps Fibre Channel	Quad Port 10GbE SR, Quad Port 10 GBase-T, or Dual Port 16 Gbps Fibre Channel	Quad Port 10GbE SR, Quad Port 10 GBase-T, or Dual Port 16 Gbps Fibre Channel	Quad Port 6 Gbps SAS

## I/O module population rules

The system chassis has eight slots for I/O modules. Slots 0, 1, 2, and 7 are reserved. Slots 3, 4, 5, and 6 support host interface I/O modules. The maximum supported number of any type of host interface I/O module is four.

**NOTE:** A maximum of three Quad Port 10 GBase-T I/O modules are supported in slots 3-6 because of the mandatory Quad Port 10 GBase-T I/O module in slot 1.

The following table assigns rules for populating the I/O modules.

**Table 117. I/O module slot population rules**

Step	I/O module name	Slots	Notes
Step 1: Populate mandatory I/O modules	NVRAM 8g Model 3	0	Mandatory for all configurations
	Quad Port 10 GBase-T	1	Mandatory for all configurations
	Quad Port 6 Gbps SAS	2	Mandatory for all configurations
	Quad Port 6 Gbps SAS	7	Mandatory for all configurations



**Table 117. I/O module slot population rules (continued)**

<b>Step</b>	<b>I/O module name</b>	<b>Slots</b>	<b>Notes</b>
Step 2: Populate all Quad Port 10GbE SR I/O modules	Quad Port 10GbE SR	3, 4, 5, 6	Populate starting from the lowest available slot number.
Step 3: Populate all Quad Port 10 GBase-T I/O modules	Quad Port 10 GBase-T	3, 4, 5, 6	Populate starting from the lowest available slot number. With Quad Port 10 GBase-T in slot 1, max number of Quad Port 10 GBase-T I/O modules are limited to 4.
Step 4: Populate all Dual Port 16 Gbps Fibre Channel I/O modules	Dual Port 16 Gbps Fibre Channel	6, 5, 4, 3	Populate starting from the highest available slot number.

# Internal system components

The following figure shows the layout of the CPUs and DIMMs inside the chassis. The front of the system is at the top of the figure.

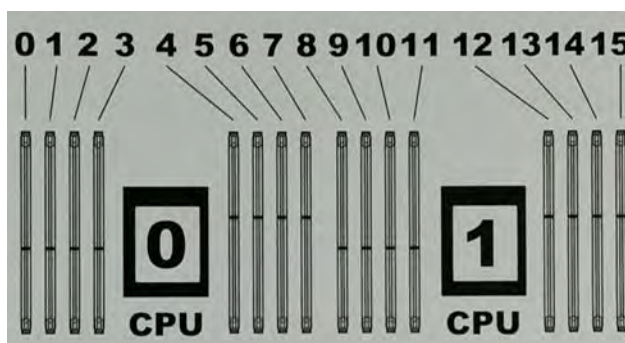


Figure 114. CPU and memory locations

## DIMMs overview

Dual in-line memory modules (DIMM) come in various sizes, which must be configured in a certain way. This topic can help you select the correct configuration when servicing DIMMs.

The storage processor contains two Intel processors each with an integrated memory controller that supports four channels of memory. The storage processor allows two DIMM slots per channel, so the storage processor supports a total of 16 DIMM slots.

## memory DIMM configuration

Table 118. memory DIMM configuration

Tier	Total Memory	Memory DIMM Configuration
DLH Expanded	384 GB	8 x 32 GB + 8 x 16 GB
DLH	192 GB	4 x 32 GB + 4 x 16 GB
DLH Extended Retention/DD Cloud Tier	384 GB	8 x 32 GB + 8 x 16 GB

HA is supported with all available memory configurations.

To ensure maximum memory performance, there are memory DIMM population rules for best memory loading and interleaving. [Memory locations - CPU 0](#) on page 192 and [Memory locations - CPU 1](#) on page 192 specify the DIMM location rules for various memory configurations:

Table 119. Memory locations - CPU 0

		Channel A		Channel B		Channel D		Channel C	
Tier	Total Memory	0	1	2	3	4	5	6	7
DLH Expanded	384 GB	32 GB	16 GB	32 GB	16 GB	16 GB	32 GB	16 GB	32 GB
DLH	192 GB	16 GB	N/A	16 GB	N/A	N/A	32 GB	N/A	32 GB
DLH Extended Retention/DD Cloud Tier	384 GB	32 GB	16 GB	32 GB	16 GB	16 GB	32 GB	16 GB	32 GB

Table 120. Memory locations - CPU 1

	Channel A	Channel B	Channel D	Channel C
--	-----------	-----------	-----------	-----------

**Table 120. Memory locations - CPU 1 (continued)**

Tier	Total Memory	8	9	10	11	12	13	14	15
DLH Expanded	384 GB	32 GB	16 GB	32 GB	16 GB	16 GB	32 GB	16 GB	32 GB
DLH	192 GB	32 GB	N/A	32 GB	N/A	N/A	16 GB	N/A	16 GB
DLH Extended Retention/DD Cloud Tier	384 GB	32 GB	16 GB	32 GB	16 GB	16 GB	32 GB	16 GB	32 GB

## DD9300 and ES30 shelf guidelines

The system rediscovers newly configured shelves after it restarts. You can power off the system and recable shelves to any other position in a set, or to another set. To take advantage of this flexibility, you need to follow these rules before making any cabling changes:

- Do not exceed the maximum shelf configuration values for your system as listed in the following table below.
- Use the Installation and Setup Guide for your system to minimize the chance of a cabling mistake.
- A system cannot exceed its maximum raw external shelf capacity, regardless of added shelf capacity.
- DD6800 systems support ES30 SATA shelves after controller upgrades from older models.
- ES30 SATA shelves must be on their own chain.

**Table 121. DD9300 and ES30 shelf configuration**

DD system	Memory required (GB)	SAS cards/port per card	ES30 support (TB)	Max shelves per set	Max number of sets	Max external capacity available (TB) <sup>1</sup>	Max RAW external capacity (TB) <sup>2</sup>
DD9300	192	2x4	SAS 30, 45, 60; SATA 15, 30, 45	7 <sup>3</sup>	4	384	480
DD9300 w/ Expanded Capacity <sup>4</sup>	384	2x4	SAS 30, 45, 60; SATA 15, 30, 45	7 <sup>3</sup>	4	720	900
DD9300 w/ Expanded Capacity or w/ HA <sup>4</sup>	384	2x4	SAS 30, 45, 60	7 <sup>3</sup>	4	720	900
DD9300 w/ ER	384	2x4	SAS 30, 45, 60; SATA 15, 30, 45	7 <sup>3</sup>	4	1440	1800
DD9300 Expanded Capacity w/ Cloud Tier	384	2x4	SAS 30, 45, 60; SATA 15, 30, 45	7 <sup>3</sup>	4	720 (max), additional 192 SAS dedicated to Cloud Tier	900 (max), additional 240 SAS dedicated to Cloud Tier
DD9300 w/ Expanded Capacity or w/ HA and Cloud Tier <sup>4</sup>	384	2x4	SAS 30, 45, 60	7 <sup>3</sup>	4	720 (max), additional 192 SAS dedicated to Cloud Tier	900 (max), additional 240 SAS dedicated to Cloud Tier

1. This figure only counts drives that have user data in the shelves.

2. The raw capacity of an ES30 is 125% of the available capacity.

3. Recommended configurations start at four shelves per set and expand beyond that as required. For HA configurations, the counts as a shelf.

## Types of cabinets and power connections

The ES30 chassis is installed in two types of racks: 40U-C (existing racks) and the 40U-P (newer racks). The racks use one phase or 3-phase power connections.

### 3-Phase power connections for 40U-P (current racks)

Some environments use 3-phase power for 40U-P racks that are used for several systems. In those situations, it is desirable to balance the current draw across all three phases. The recommended 3-phase power cabling attempts to do that, but an optimal configuration depends on the specific installation.

## Cabling shelves

### NOTE:


- Before cabling the shelves, physically install all shelves in the racks. Refer to the rail kit installation instructions included with the ES30 shelf for rack mounting.
- The documentation refers to two SAS HBAs. If only one HBA is allowed in a system, then use another port as defined later for that specific system.
- On an HA system, add cables from the second node to open ports at the end of the sets. The ports on the second node must connect to the same sets as the corresponding ports on the first node.

Ports on the system's SAS HBA cards connect directly to a shelf controller's host port. For redundancy, you need to create dual paths by using a port on one SAS HBA card to connect to one shelf controller in each shelf set, and a port on another SAS HBA card to connect to another shelf controller in the same shelf set. With dual paths, if one SAS HBA card fails, the shelf is still operational. However, in the unlikely event any single shelf becomes completely disconnected from power or SAS cables and becomes disconnected from a previously operational shelf, the file system goes down and the shelf is not operational. This is considered a double failure.

There are two kinds of configurations: one shelf in a set or multiple shelves in a set.

## DD6300, DD6800, and DD9300 shelf configurations

There are a few rules that must be followed when adding a mixture of DS60 and other shelf types to your system.

 **CAUTION: If a system does not follow ALL of these rules it is not a legitimate configuration.**

Prerequisites:

- You cannot exceed the maximum amount of raw capacity displayed in the cabling table for each system.
- You cannot exceed the maximum number of shelves displayed in the cabling table for each system.
- There are no specific placement or cabling requirements for SSD shelves, or the metadata shelves for Cloud Tier configurations. These shelves can be installed and cabled the same way as standard ES30 shelves.

**Table 122. Minimum and maximum configurations**

System	Appliance	Minimum appliance shelf count*	Max appliance shelf count
	48 TB usable	0	1
w/ Expansion	144 TB usable	1	5
	144 TB usable	2	28
w/ Expansion	288 TB usable	2	28
w/ High Availability (HA)	288 TB usable	2	28
w/ Extended Retention (ER)	576 TB usable	2	28

**Table 122. Minimum and maximum configurations (continued)**

System	Appliance	Minimum appliance shelf count*	Max appliance shelf count
w/ Cloud Tier	288 TB usable (96 TB for Cloud Tier)	2	28
w/ HA and Cloud Tier	288 TB usable (96 TB for Cloud Tier)	2	28
	384 TB usable	3	28
w/ Expansion	720 TB usable	3	28
w/ HA	720 TB usable	3	28
w/ ER	1440 TB usable	7	28
w/ Cloud Tier	720 TB usable (192 TB for Cloud Tier)	7	28
w/ HA and Cloud Tier	720 TB usable (192 TB for Cloud Tier)	7	28

\* The minimum appliance shelf count does not include shelves for Cloud Tier.

## DD9300 and DS60 shelf guidelines

The system rediscovers newly configured shelves after it restarts. You can power off the system and recable shelves to any other position in a set, or to another set. To take advantage of this flexibility, you need to follow these rules before making any cabling changes:

- Do not exceed the maximum shelf configuration values for your system as listed in the following table.
- For redundancy, the two connections from a system to a set of shelves must use ports on different SAS I/O modules.
- Use the Installation and Setup Guide for your system to minimize the chance of a cabling mistake.
- A system cannot exceed its maximum raw external shelf capacity, regardless of added shelf capacity.
- ES30 SATA shelves must be on their own chain.
- If ES30 SAS shelves are on the same chain as a DS60, the maximum number of shelves on that chain is 5.

**Table 123. DD9300 and DS60 shelf configuration**

DD system	Memory required (GB)	SAS cards/port per card	DS60 support (TB)	Max shelves per set	Max number of sets	Max external capacity available (TB) <sup>1</sup>	Max RAW external capacity (TB)
DD9300 <sup>2, 3, 4</sup>	192 <sup>5</sup>	2x4	SAS 45, 60	3	4	384	480
DD9300 w/ Expanded Capacity <sup>2, 3, 6</sup>	384	2x4	SAS 45, 60	3	4	720	900
DD9300 w/ Expanded Capacity and w/ HA <sup>2, 3</sup>	384	2x4	SAS 45, 60	3	4	720	900
DD9300 w/ Expanded Capacity and w/ ER <sup>2, 3, 7</sup>	384	2x4	SAS 45, 60	3	4	1440	1800
DD9300 w/ Expanded Capacity and w/ Cloud Tier <sup>3, 8</sup>	384	2x4	SAS 45, 60	3	4	720 + 192 for Cloud Tier	900 + 240 for Cloud Tier
DD9300 w/ Expanded Capacity	384	2x4	SAS 45, 60	3	4	720 + 192 for Cloud Tier	900 + 240 for Cloud Tier

**Table 123. DD9300 and DS60 shelf configuration (continued)**

DD system	Memory required (GB)	SAS cards/port per card	DS60 support (TB)	Max shelves per set	Max number of sets	Max external capacity available (TB) <sup>1</sup>	Max RAW external capacity (TB)
and w/ HA and Cloud Tier <sup>3, 8</sup>							

**NOTE:** An entry of 45 corresponds to DS60-3 models and an entry of 60 corresponds to DS60-4 models.

1. This column only counts drives that have user data in the shelves. For example, a DS60 4-240 has 192TB.
2. With DD OS 6.x and greater & SSD.
3. Only available with DD OS 6.x and greater.
4. DD9300 base support 2.5 DS60-4 180 x 2 plus DS60-2 90, if a half-filled DS60 is necessary.
5. While it is 192GB, it is a different memory DIMM configuration compared to DD6300 's 192GB.
6. DD9300 Expanded supports five DS60 maximum.
7. There is no support for HA with SATA drives.
8. The maximum shelf count for any specific drive/shelf size might be less than the product of max shelves x max shelves per set.

### 3-phase power connections for 40U-P (current racks)

Some environments use 3-phase power for 40U-P racks used for several systems. In those situations it is desirable to balance the current draw across all 3 phases. The recommended 3-phase power cabling attempts to do that, but an optimal configuration is dependent on the specific installation.

### shelf configurations

There are a few rules that must be followed when adding a mixture of DS60 and other shelf types to your system.

**CAUTION:** If a system does not follow all these rules, it is not a legitimate configuration.

Prerequisites:

- You cannot exceed the maximum amount of raw capacity displayed in cabling table for each system.
- You cannot exceed the maximum number of shelves displayed in cabling table for each system.
- You cannot connect more than three DS60 shelves in a single set.

**Table 124. Minimum configurations**

System	Appliance maximum	Minimum appliance DS60 shelf count
	144 TB	0
	144 TB	2
w/ High Availability (HA)	288 TB	2 (plus 1 FS15 for SSD cache)
w/ Extended Retention (ER)	576 TB	2
w/ Cloud Tier	384 TB (96 TB for Cloud Tier)	2 (plus 2 ES30s for Cloud Tier)
w/ HA and Cloud Tier	384 TB (96 TB for Cloud Tier)	2 (plus 1 FS15 for SSD cache, and 2 ES30s for Cloud Tier)
	384 TB	3
w/ HA	720 TB	3 (plus 1 FS15 for SSD cache)
w/ ER	1440 TB	3
w/ Cloud Tier	912 TB (192 TB for Cloud Tier)	3 (plus 4 ES30s or 1 DS60 for Cloud Tier)



**Table 124. Minimum configurations (continued)**

<b>System</b>	<b>Appliance maximum</b>	<b>Minimum appliance DS60 shelf count</b>
w/ HA and Cloud Tier	912 TB (192 TB for Cloud Tier)	4 (plus 1 FS15 for SSD cache, and 4 ES30s or 1 DS60 for Cloud Tier)

1. DS60 will only be partially filled.

- A Cloud Tier system shares the ERSO cabling configuration; however, Cloud Tier has a lower maximum.
- It is recommended that the shelf with the greater number of drives should always be placed in the bottom position.
- only supports one DS60.
- only has one SAS SLIC and all DS60 connections are made to that single SAS SLIC.
- only has one SAS SLIC and all DS60 connections are made to that single SAS SLIC.

## DD9400

This chapter contains the following topics:

**Topics:**

- [DD9400 system features](#)
- [DD9400 system specifications](#)
- [DD9400 storage capacity and configurations](#)
- [DD9400 front panel](#)
- [DD9400 SSD usage and configurations](#)
- [Rear panel](#)
- [PCIe HBAs](#)
- [DD9400 DIMM configurations](#)
- [DD6900, DD9400, and DD9900 storage shelves configurations and capacities](#)

## DD9400 system features

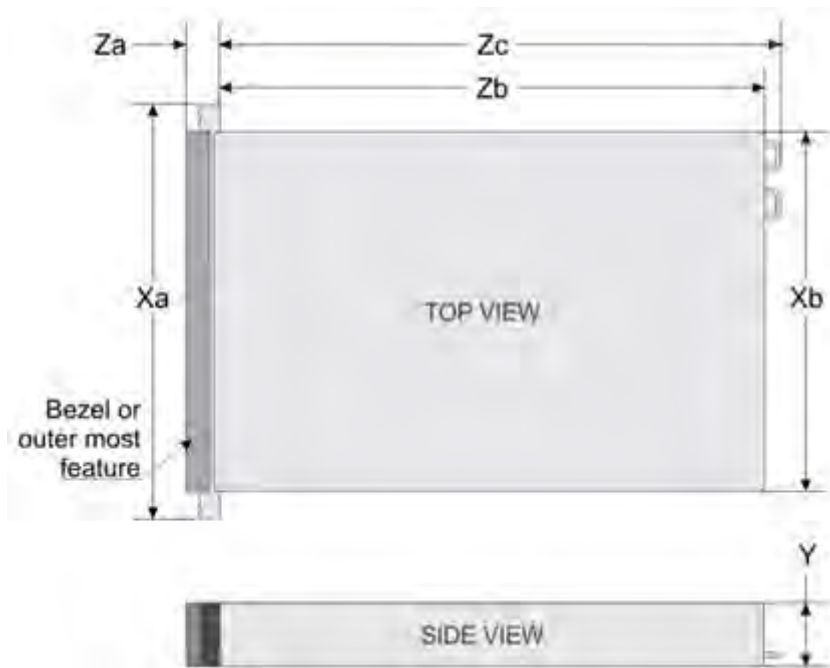
**Table 125. DD9400 system features**

Configurations		Single Node	HA A-P
Processor		2 x Intel Xeon Gold, 2294 Mhz, 16C	
Kernel		4.4	
Memory Configurations	Total	576 GB	
	DIMMs	12 x 16 GB + 12 x 32 GB	
HDD Drive Size		8TB	
Supported Capacity	Active Tier	192 <-> 768 TBu	
	Cloud Tier	1536 TBu	
Disk Groups	Active Tier	2 <-> 8	
	Over Provisioning	2	
	Cloud Tier (4 TB)	4	
SSDs for OS in 2.5" bays in head		4, 1.92 TB, 1 WPD	
Stream Count		800 Wr, 220 Rd	
Cache SSDs in 2.5"	2.5%	5 (internal) 3.84 TB	5 (External) 3.84 TB
Cache SSD shelf	FS25	0	1
HA Private Interconnect		N/A	(2) 10G Base-T ports (NDC)
16 GB NVRAM		1	
HW Accelerator	100 Quick Assist Technology (QAT) 8970	1	
Internal SAS	HBA330 12 Gbps SAS controller	1	

**Table 125. DD9400 system features (continued)**

Configurations		Single Node	HA A-P
External SAS	PMC Quad Port 12 Gbps SAS	3	
SAS String Depth (max)	ES30/ES40	6 (7 for Cloud Tier)	
	DS60	3	
Host interface HBAs	2-port QL41000 25 GbE-SFP28	4 maximum	
	4-port QL41164 10 GbE-SFP+	4 maximum	
	4-port QL41164 10GBASE-T	4 maximum	
	4-port QLE2694 16 Gb FC	3 maximum	
Network Daughter Card option	4-port QL41000 10 GbE-SP+ FasLinQ	1	
	4-port QL41164 10GBASE-T	1	

## DD9400 system specifications



**Figure 115. System dimensions**

**Table 126. DD9400 system specifications**

Xa	Xb	Y	Za (with bezel)	Za (without bezel)	Zb	Zc
482.0 mm (18.98 inches)	434.0 mm (17.09 inches)	86.8 mm (3.42 inches)	35.84 mm (1.41 inches)	22.0 mm (0.87 inches)	678.8 mm (26.72 inches)	715.5 mm (28.17 inches)

A DD9400 system weighs up to 63.05 lbs (28.6 kg).

**Table 127. System operating environment**

Operating Temperature	50° to 95° F (10° to 35° C), derate 1.1° C per 1000 feet, above 7500 feet up to 10,000 feet (32.25° C at 10,000)
Operating Humidity	20% to 80%, non-condensing
Non-operating Temperature	-40° to +149° F (-40° to +65° C)
Operating Acoustic Noise	L <sub>wad</sub> sound power, 7.5 Bels

## DD9400 storage capacity and configurations

The following table provides storage capacity and configuration information for the DD9400 system.

**Table 128. DD9400 storage capacity and configurations**

Tier	CPU-SP SKU	Memory	Front 2.5" SSDs	Max. Useable Capacity	Cloud Tier Metadata
DD9400	16 core, 125 W 5218	576 GB (12 x 16 GB) + (12 x 32 GB)	5 (2.5%)	768TBu	N/A
DD9400 with DD Cloud Tier <sup>1</sup>	16 core, 125 W 5218	576 GB (12 x 16 GB) + (12 x 32 GB)	5 (2.5%)	1248TBu	240 TB raw/192 TB usable

<sup>1</sup> DD Cloud Tier can be added to a DD9400 and is enabled by a license and disk packs for the DD Cloud Tier metadata.

The Memory column lists the total memory that is required and the number and type of the DIMMs used. All memory DIMMs are DDR4 RDIMMs at the highest supported speed of 2666MT/s.

## High Availability

DD9400 supports Active-Passive High Availability (A-P HA or just A-P). The following table summarizes the hardware changes to support A-P HA:

**Table 129. HA configuration requirements**

Hardware Change to support HA	Active-Passive HA
Additional memory	No extra memory required.
HA private interconnect	Cluster Interconnect : A-P requires the use of two ports from the on-board quad-port 10 GbE Network Daughter Card.
NVRAM	A-P requires a single 16 GB NVRAM card (same as non-HA).
SAS Connectivity	Both nodes of an A-P HA pair require redundant SAS connectivity to the storage array. (Note: a single node system also has redundant connectivity to the storage array.)
SSD Requirements	SSDs are contained within FS25 and are available from both nodes.

## HA Network Interconnect

The HA Network Interconnect, required for HA configurations, is a dedicated 10 GbE connection between the two nodes of an HA pair. The interconnect is used to write data (and metadata) from the active node's NVRAM to the passive node's NVRAM.

Two 10GbE links are used to meet the bandwidth requirements for the private interconnect. Traffic across the private interconnect has roughly the same bandwidth as is written to the NVRAM card. The dual 10-GbE links can move about 2 GB/s in each direction.

## HA SAS Interconnect

HA configurations require that the SSDs' cache drives be shared between both nodes and have redundant SAS connections to all shelves.

## DD9400 front panel



Figure 116. DD9400 front panel

Table 130. Front panel features

Item	Ports, panels, and slots	Description
1	Left control panel	Contains system health and system ID, status LED, and optional iDRAC Quick Sync 2 (wireless).
2	Drive slots	Enable you to install drives that are supported on your system.
3	Right control panel	Contains the power button, VGA port, iDRAC Direct micro USB port, and two USB 2.0 ports.
4	Information tag	The Information tag is a slide-out label panel that contains system information such as Service Tag, NIC, MAC address, and so on. If you have opted for the secure default access to iDRAC, the Information tag also contains the iDRAC secure default password.

Table 131. Front LEDs

Name	Color	Purpose
Control Panel Status LED	Blue/Amber	Status: <ul style="list-style-type: none"> <li>• Healthy: Solid Blue</li> <li>• Fault: Blink Amber</li> <li>• Sys ID: Blink Blue</li> </ul>
System Power Button/LED	Green	Indication that the system has power.
Drive activity LEDs	Green	Lit green when the drive is powered. Blinks during drive activity.
Drive service LEDs	Green	Lit solid amber when a disk drive needs service.

# Front LEDs

Figure 117. Front left control panel status LEDs



**NOTE:** The indicators display solid amber if any error occurs.

Table 132. System health and system ID indicator codes

System health and ID indicator code	
Solid blue	Indicates that the system is turned on, system is healthy, and system ID mode is not active. Press the system health and system ID button to switch to system ID mode.
Blinking blue	Indicates that the system ID mode is active. Press the system health and system ID button to switch to system health mode.
Solid amber	Indicates that the system is in fail-safe mode.
Blinking amber	Indicates that the system is experiencing a fault. Check the System event log or the LCD panel, if available on the bezel, for specific error messages.



Figure 118. Front right control panel power button LEDs



**Table 133. Right control panel features**

Item	Indicator, button, or connector	Description
1	Power button	Indicates if the system is turned on or off. Press the power button to manually turn on or off the system. <b>NOTE:</b> Press the power button to gracefully shut down an ACPI-compliant operating system.
2	USB port (2)	The USB ports are 4-pin, 2.0-compliant. These ports enable you to connect USB devices to the system.
3	iDRAC Direct port	The iDRAC Direct port is micro USB 2.0-compliant. This port enables you to access the iDRAC Direct features.
4	iDRAC Direct LED	The iDRAC Direct LED indicator lights up to indicate that the iDRAC Direct port is connected.
5	VGA port	Enables you to connect a display device to the system.

**Table 134. iDRAC Direct LED indicator codes**

iDRAC Direct LED indicator code	Condition
Solid green for two seconds	Indicates that the laptop or tablet is connected.
Flashing green (on for two seconds and off for two seconds)	Indicates that the laptop or tablet that is connected is recognized.
Turns off	Indicates that the laptop or tablet is unplugged.



**Figure 119. Drive LEDs**

The front contains 25 2.5" disk drive slots that can be populated with SSDs. Each SSD is housed in a drive carrier that contains two LEDs at the bottom of the carrier. The carrier's left blue LED is lit whenever an SSD is present in the slot, and it blinks when I/O activity is occurring on the disk. The right amber LED is usually off and lights amber to indicate that the disk is faulted and must be serviced.

## DD9400 SSD usage and configurations

DD9400 system uses a 16 x 2.5" drive slot mid-plane. In addition to the OS drives, it allows up to 12 SSD drives for metadata cache implementation.

## SSD configurations

The SSD slots on the front of the enclosure are shown below. The system come from the factory with SSDs populated in the enclosure.



Figure 120. DD9400 SSD slot assignment

DD9400 supports 2.5" SSD option out of factory. Based on 3.84 TB SSD capacity, the required number of SSDs for each DD9400 configuration is provided in the following table.

Table 135. DD9400 SSD configurations

Configuration	Single node	HA
3.84 TB SSDs in 2.5" bays	5 (internal) 3.84 TB	5 (internal) 3.84 TB

The cache SSDs are installed right to left starting from slot 7 down.

## SSD boot drives

Additional SAS SSDs are used to boot the DD OS operating system. Boot disks and/or external disk shelves are used to log system information. Boot disks are installed from the other end of the front 2.5" disk slots to physically differentiate the cache SSDs.

Table 136. SSD boot drives

# of boot disks	Installed in slots
4	0,1,2,3

## Rear panel



Figure 121. System rear panel

Item	Panels, ports, and slots	Description
1	Full-height PCIe expansion card slot (3)	The PCIe expansion card slot (riser 1) connects up to three full-height PCIe expansion cards to the system.
2	Half-height PCIe expansion card slot	The PCIe expansion card slot (riser 2) connects one half-height PCIe expansion cards to the system.
3	Rear handle	The rear handle can be removed to enable any external cabling of PCIe cards that are installed in the PCIe expansion card slot 6.
4	Full-height PCIe expansion card slot (2)	The PCIe expansion card slot (riser 2) connects up to two full-height PCIe expansion cards to the system.
5	Full-height PCIe expansion card slot (2)	The PCIe expansion card slot (riser 3) connects up to two full-height PCIe expansion cards to the system.
6	Power supply unit (2)	Supports two AC power supply units (PSUs)
7	NIC ports	The NIC ports that are integrated on the network daughter card (NDC) provide network connectivity.
8	USB port (2)	The USB ports are 9-pin and 3.0-compliant. These ports enable you to connect USB devices to the system.
9	VGA port	Enables you to connect a display device to the system.
10	Serial port	Enables you to connect a serial device to the system.
11	iDRAC9 dedicated port	Enables you to remotely access iDRAC.
12	System identification button	The System Identification (ID) button is available on the front and back of the systems. Press the button to identify a system in a rack by turning on the system ID button. You can also use the system ID button to reset iDRAC and to access BIOS using the step through mode.

## Rear LEDs



**Figure 122. Onboard ID and iDRAC LEDs**

1. iDRAC management port:
  - a. The green link LED on the left is lit whenever there is link at 1000BaseT and 100BaseT speeds. The link LED is off when the link speed is 10BaseT or there is no link.
  - b. The green link LED on the right blinks whenever there is traffic on the port.
2. System identification LED: This blue LED can be turned on by software to visually identify the system.

## PSU FRU LEDs

There are two power supplies, one in the upper left of the rear chassis and one on the bottom right. Each power supply has three LEDs: AC good, DC good, and Service. The top PSU is "right-side up" and the bottom PSU is "upside down."

**Table 137. PSU FRU LEDs**

Name	Color	Definition
AC Good	Green	AC input is as expected.
DC Good	Green	DC output is as expected.
Service	Amber	PSU has a fault condition and a must be replaced.

## PCIe HBAs

A slot in the chassis that does not contain an HBA must have a filler panel installed in the empty slots. This is required for EMI compliance.

This system supports nine I/O modules slots, seven of which are 8-lane PCIe Gen3, and two are 16-lane PCIe Gen3. Several networking, NVRAM, SAS, and Fibre Channel I/O modules are supported.

## Slot assignment

The following table lists the DD9400 configuration slot assignments:

**Table 138. DD9400 slot assignments**

Description	Slot
QLogic, 41164 4 Port, 10GbE SFP+ PCIe, Full Height	5, 8, 1
QLogic, 41164 4 Port, 10GBASE-T PCIe, Full Height	5, 8, 1
QLogic, 41164 4 Port, 10GBASE-T PCIe, Low Profile	6
QLogic, 41262 2 Port, 25Gb SFP28 PCIe, Full Height	5, 8, 1
QLogic, 41262 2 Port, 25Gb SFP28 PCIe, Low Profile	6
HBA330 SAS Controller, 12Gbps Mini card	mini/mono
QAT,INTEL,8970,FH, Avnet p/n 1QA89701G1P5	4
PM8072,SAS12,4P,FH, MicroSemi 2295200-R	3, 7, 5
FC16,QLE2694-DEL-BK,TRG,QP,FH	5, 8, 1
16GB NVRAM,FH	2

Host Interface (x16) is 2-port 100 Gb QSFP+ Ethernet.

Host Interface (x8) are:

- 4-port 25 Gb SFP28 Ethernet
- 4-port 10 Gb SFP+ Ethernet
- 4-port 10GBaseT Ethernet
- 4-port 16 Gb Fibre Channel

**NOTE:** Any of the Host Interface (x8) may be inserted into the slots 0, 1, 2, & 5, but the Host Interface (x16) may only reside in slots 0 & 2 (the x16 SLIC slots).

SAS is 4-port 12 Gb SAS and is required for HA configurations.

NVRAM is the 16GB NVRAM.

SAS Mezzanine is 2-port 12 Gb Mini-SAS HD SAS controller mezzanine.

Host Interface Mezzanine is either:

- 4-port 10GBaseSR SFP+ Ethernet mezzanine
- 4-port 10GBaseT RJ45 Ethernet mezzanine

## I/O population rules

The following figures show the I/O module slot numbers.

The slot labeled N is the network daughter card, which contains ports ethMa, ethMb, ethMc, and ethMd.

The physical interface name format for the other I/O module slots is ethXy, where X is the slot number and y is an alphanumeric character. For example, eth0a.

For most horizontal I/O module NIC interfaces, the port numbering goes from left to right, with ethXa on the left. The horizontal I/O module slots on the left-in slots 1-3 are inverted. The port numbering on these I/O modules in these slots goes from right to left, with ethXa on the right.

The management port ethMa is the first port set up by the Configuration Wizard. It is marked with a red rectangle in the figure below.



Figure 123. Slot numbering

The general population rules can be summarized as:

1. Populate a given I/O in the available slots listed.
2. Select the first available slot in the group.
3. Follow the steps for each I/O in the order specified.
4. Slots 0 and 2 should be reserved for x16 unless there are no available x8 slots.

**NOTE:** Installing HBAs requires opening the system and installing the HBA into the riser.

Riser#	Slots (from top to bottom)
1	1, 2, 3
2	4, 5, 6, N
3	7, 8

## Gen3 PCIe

Slots support Gen3 PCIe.

## I/O module servicing

All I/O modules are user serviceable and may be replaced when the system is powered off. On-line service of I/O modules is not support. A module that is hot-inserted into the system will remain powered off and will not be powered on until the next reboot of the system. A module that is hot-removed causes an operating system to immediately reboot.

## DD9400 DIMM configurations

The SP Module contains two Intel SP processors each with an integrated memory controller that supports six channels of DDR4 memory. The CPU allows two DIMM slots per channel, so the SP Module supports 24 DIMM slots.

Each DDR4 DIMM is connected to the system board through an industry standard 288-pin DDR4 DIMM connector. This system uses registered DIMMs with Dell EMC ControlCenter at 72 bits wide (64-bits data + 8-bits Dell EMC ControlCenter) up to a maximum of 2666MT/s speed.

**Table 139. Memory configurations**

Tier	Total Memory	Memory DIMM Configuration
DD9400 Base	576 GB	12 x 32GB + 12 x 16GB
DD9400 Cloud Tier	576 GB	12 x 32GB + 12 x 16GB

## Memory locations

To ensure maximum memory performance, there are memory DIMM population rules so that the memory loading and interleaving are optimal. The following table specifies the DIMM location rules. Each DIMM location contains contains a 16GB DIMM or a 32GB DIMM.

**Table 140. DD9400 base DIMM configuration CPU 1**

Total (GB)	Channel C		Channel B		Channel A		Channel D		Channel E		Channel F	
	J0	J1	J2	J3	J4	J5	J6	J7	J8	J9	J10	J11
576	32GB	16GB	32GB	16GB	32GB	16GB	16GB	32GB	16GB	32GB	16GB	32GB

**Table 141. DD9400 base DIMM configuration CPU 2**

Total (GB)	Channel C		Channel B		Channel A		Channel D		Channel E		Channel F	
	J12	J13	J14	J15	J16	J17	J18	J19	J20	J21	J22	J23
576	32GB	16GB	32GB	16GB	32GB	16GB	16GB	32GB	16GB	32GB	16GB	32GB

## DD6900, DD9400, and DD9900 storage shelves configurations and capacities

DD6900, DD9400, and DD9900 do not store data on internal disk drives and rely on external disk array shelves to provide storage. DS60 disk shelves and ES40 shelves are connected to systems using 12 Gb Mini-SAS HD ports, which are implemented on the SAS HBAs.

The systems also support external metadata storage (cache) shelf FS25. External cache shelf only hosts DD OS depended metadata for performance acceleration.

The ES40 SAS shelf contains 15 drives, which includes 12 drives of usable storage, two parity drives, and one hot spare.

The DS60 shelf contains 60 drives. Drives are configured in four groups of 15 drives. Each group contains two parity drives and one hot spare, so each group provides 12 drives of usable storage. A fully configured DS60 shelf provides 48 drives of usable storage.

**Table 142. Shelves shipped from factory, in rack**

DD6900	DD9400	DD9900
4 TB ES40	8 TB DS60	8 TB DS60

**Table 143. Shelves shipped from factory, boxed**

DD6900	DD9400	DD9900
4 TB ES40	8 TB ES40	8 TB ES40
4 TB DS60	8 TB DS60	8 TB DS60



**Table 144. Additional shelves supported**

DD6900	DD9400	DD9900
4 TB SAS ES30/DS60	4 TB SAS ES30/DS60	4 TB SAS ES30/DS60
3 TB SAS ES30/DS60	3 TB SAS ES30/DS60	3 TB SAS ES30/DS60

**i** **NOTE:** 3 TB shelves are only support on controller upgrades and not on fresh installs.

**Table 145. Shelf usable capacities**

Hard drive size (TB)	Shelf	Useable TB
4	ES40	48
4	DS60	192
8	DS60	384

The following table lists the maximum number of shelves per chain:

**Table 146. Supported shelf count per chain**

Shelf type	Max # from factory	Max # per chain
SAS ES30/ES40	4	7
DS60	2	3
DS60 + ES30/ES40	n/a	5
F25	1	1

The connector type for ES30 is Mini-SAS. Special cables may be necessary when combining ES30 and ES40 shelves on the same chain (enabled but not recommended).

DD9400 and DD9900 system capacities are optimized for use with DS60 shelves containing 8 TB drives. DS60 shelves can be populated with one to four packs of fifteen 8 TB, or 4 TB drives. Different 4 TB and 8 TB capacity disk packs may be mixed within a single DS60 shelf. ES40 SAS shelves and DS60 shelves of mixed capacities may be attached so long as the maximum storage capacity of the system is not exceeded.

# DD9500

This chapter contains the following topics:

**Topics:**

- [System features](#)
- [System specifications](#)
- [DD9500 storage capacity](#)
- [Front panel](#)
- [Rear panel](#)
- [I/O module slot assignments](#)
- [Internal System Components](#)
- [DD9500 and ES30 shelf guidelines](#)
- [DD9500 and DS60 shelf guidelines](#)

# System features

Table 147. DD9500 system features

Feature		DD9500 (Base configuration)	DD9500 (Expanded configuration)
Rack height		4U, supported in four-post racks only	4U, supported in four-post racks only
Rack mounting		Rack mount kit included with each system. Adjustable between 24 - 36 in. (60.9–76.2 cm).	Rack mount kit included with each system. Adjustable between 24 - 36 in. (60.9–76.2 cm).
Power		4 hot-swappable power units, 2 pairs of 1 +1 redundant	4 hot-swappable power units, 2 pairs of 1 +1 redundant
Voltage		200–240 V~. Frequency: 50 Hz to 60 Hz.	200–240 V~. Frequency: 50 Hz to 60 Hz.
Processor		4 Intel EX processors.	4 Intel EX processors.
NVRAM		One 8-GB NVRAM module for data integrity during a power outage	One 8-GB NVRAM module for data integrity during a power outage
Fans		8 hot-swappable fans, redundant	8 hot-swappable fans, redundant
Memory		32 x 8 GB DIMM (256 GB)	32 x 8 GB DIMM + 16 x 16 GB DIMM (512 GB)
Internal drives		4 x 400 GB (base 10) hot-swappable solid state drives (SSD)	4 x 400 GB (base 10) hot-swappable solid state drives (SSD)
I/O module slots		11 I/O module (Fibre Channel, Ethernet, and SAS) slots. Replaceable I/O modules are not hot-swappable. See <a href="#">I/O module slot assignments</a> on page 222	11 I/O module (Fibre Channel, Ethernet, and SAS) slots. Replaceable I/O modules are not hot-swappable. See <a href="#">I/O module slot assignments</a> on page 222
Supported capacity	Non-extended retention	540 TB	1080 TB
	DD Cloud Tier	N/A	2160 TB <sup>a</sup>
	Extended retention	N/A	1080 TB <sup>b</sup>
High availability support		Yes	Yes
HA private interconnect		4 10 GbE optical ports	4 10 GbE optical ports
External SSD shelf		Optional 1 x 8 drive SSD shelf	Optional 1 x 15 drive SSD shelf

a. DD Cloud Tier requires five ES30 shelves fully populated with 4 TB drives to store DD Cloud Tier metadata.

b. Extended retention not available on HA configurations

# System specifications

Table 148. DD9500/DD9800 system specifications

Model	Watts	BTU/hr	Power (VA)	Weight	Width	Depth	Height
DD9500/ DD9800	1887	6444	1981	117 lb / 53.2 kg	19 in / 48.3 cm	29.5 in / 74.9 cm	7 in / 17.8 cm

- Operating temperature: 50° to 95° F (10° to 35° C), derate 1.1° C per 1000 feet, above 7500 feet up to 10,000 feet
- Operating humidity: 20% to 80%, non-condensing
- Non-operating temperature: -40° to +149° F (-40° to +65° C)
- Operating acoustic noise: Sound power, LWAd, is 7.7 bels.

## DD9500 storage capacity

The table lists the capacities of the systems. The internal indexes and other product components use variable amounts of storage, depending on the type of data and the sizes of files. If you send different datasets to otherwise identical systems, one system may, over time, have room for more or less actual backup data than another.

**NOTE:** The system commands compute and display amounts of disk space or data as decimal multiples of certain powers of two ( $2^{10}$ ,  $2^{20}$ ,  $2^{30}$ , and so forth). For example, 7 GiB of disk space =  $7 \times 2^{30}$  bytes =  $7 \times 1,073,741,824$  bytes. The system sees this process as Base 2 calculation.

**Table 149. DD9500 storage capacity**

System/Installed Memory	Internal Disks	Raw Storage (Base 10)	Data Storage Space (Base 2 Calculation)	Data Storage Space (Base 10 Calculation)
DD9500 (3 SAS I/O modules) 256 GB	2.5 in.; 4 x 400 GB SATA SSD  No User Data	540 TB (external)	392.9 TiB	432 TB
DD9500 (3 SAS I/O modules) 512 GB	2.5 in.; 4 x 400 GB SATA SSD  No User Data	1,080 TB (external)	786.8 TiB	864 TB
DD9500 with DD Cloud Tier software (4 SAS I/O modules) 512 GB	2.5 in.; 4 x 400 GB SATA SSD  No User Data	3,240 TB (external)	2360.4 TiB	2592 TB
DD9500 with Extended Retention (ER) software (4 SAS I/O modules) 512 GB	2.5 in.; 4 x 400 GB SATA SSD  No User Data	2,160 TB (external)	1573.6 TiB	1728 TB

**Table 150. DD9500 with ES30 SAS shelves**

	DD9500	DD9500
Memory (GB)	256	512
SAS I/O modules x ports per module	3x4	3x4
ES30 support (TB)	SAS 30, 45, 60	SAS 30, 45, 60
Maximum shelves per set	5	5
Maximum number of sets	6	6

**NOTE:** ES30 SATA shelves are supported when upgrading from an older single node system, but are not supported with HA pairs or new installations.

**Table 151. DD9500 with DS60 shelves**

	DD9500	DD9500
Memory (GB)	256	512
SAS I/O modules x ports per module	3x4	3x4
DS60 support (TB)	SAS 45, 60	SAS 45, 60
Maximum shelves per set	4	4
Maximum number of sets	6	6

# Front panel

The four solid state drives (SSDs), the storage processor (SP), and the fans are accessed from the front of the system. The SP must be pulled out to provide access to the DIMMs. The fans are accessed without pulling or removing the SP and they are hot-swappable. The photo shows the interfaces on the front of the system.

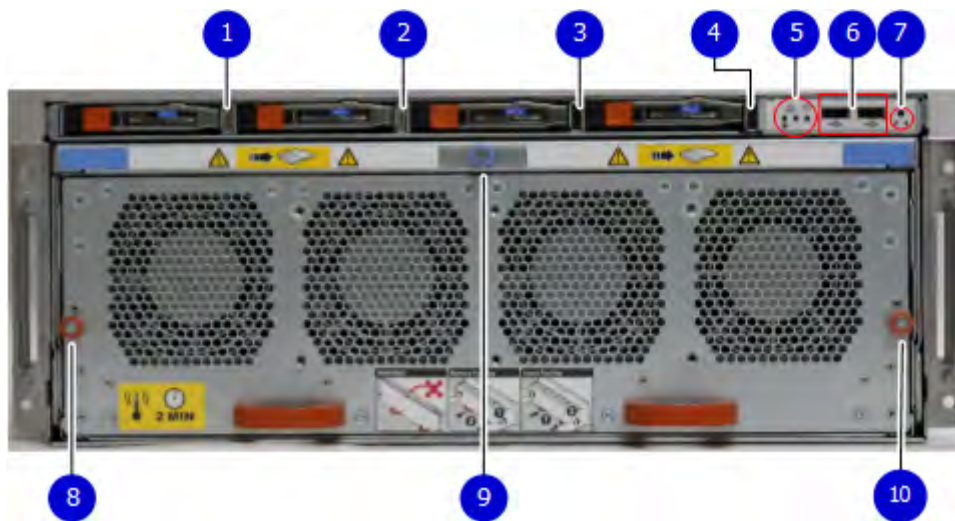


Figure 124. Front panel components

1. SSD slot 0
2. SSD slot 1
3. SSD slot 2
4. SSD slot 3
5. Front LEDs
6. USB ports
7. Power button
8. Fan tray thumbscrew (left)
9. SP module thumbscrew to secure the ejector handle
10. Fan tray thumbscrew (right)

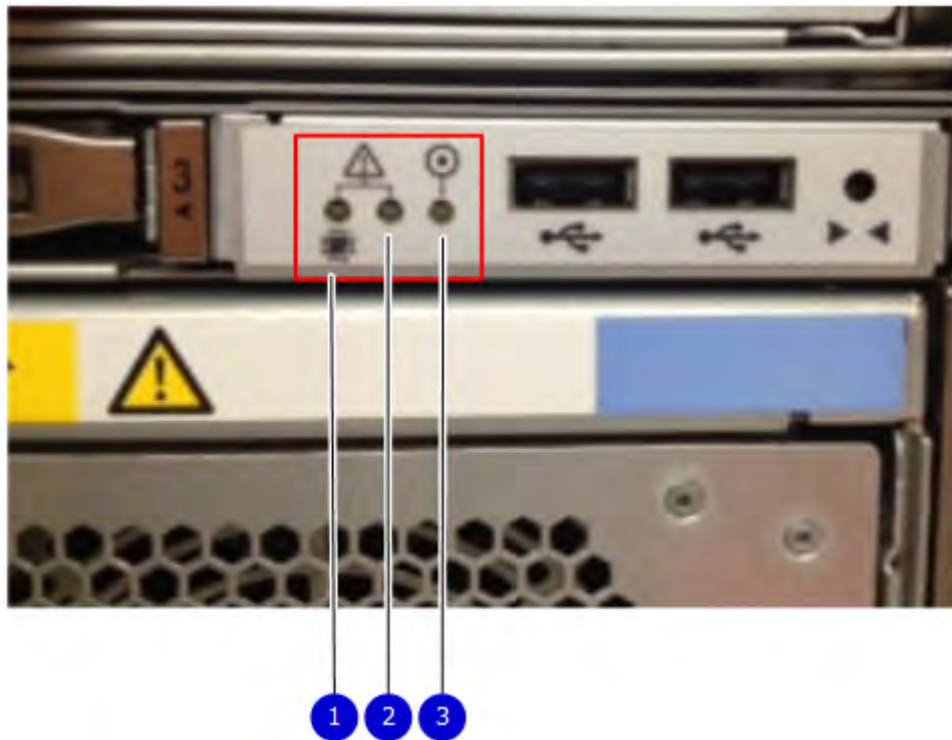
## Front LED indicators

On the front panel to the right of SSD #4 (in Slot 3) are 3 LEDs that show high level system status. The System Power LED glows blue to show the system is powered on.

**NOTE:** The system can have power (be plugged in) but the blue LEDs are off if the system is powered off.

The SP Service LED is normally off, but glows amber whenever the storage processor (SP) requires service. The Enclosure Service LED is normally off, but glows amber whenever the SP or other replaceable parts require service. The System Power and Enclosure Service LEDs are visible through the front bezel.

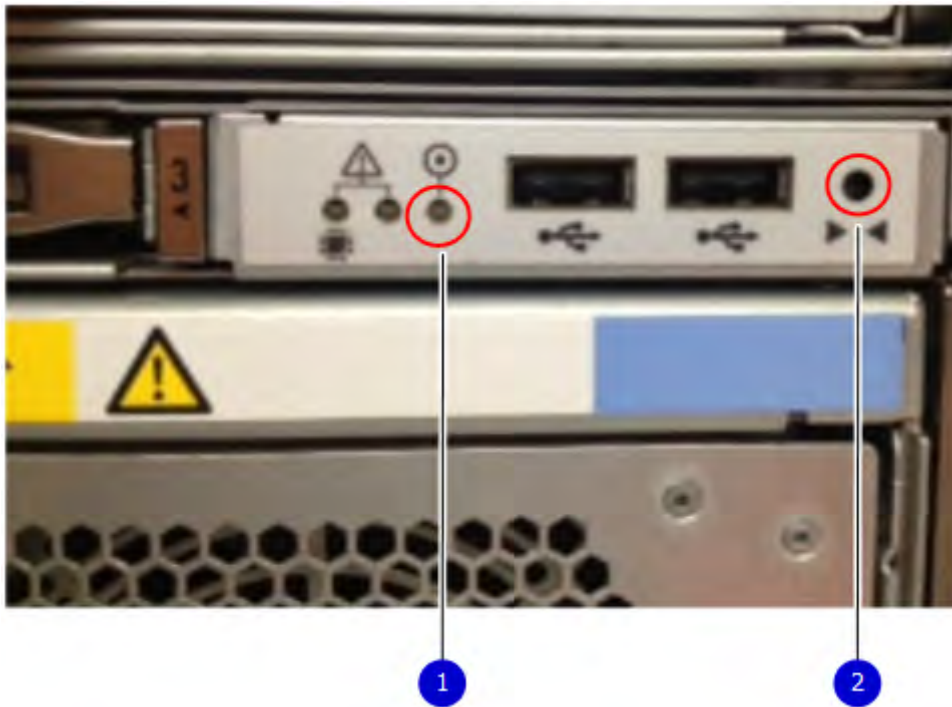




**Figure 125. Service LEDs**

1. SP service LED — Amber light indicates that the SP or one of its components needs service.
2. Enclosure Service LED — This is normally off, but amber light indicates that the enclosure or something within the enclosure— the fans, SP, I/O modules, management module etc—requires service.
3. System power LED — Blue light indicates system running

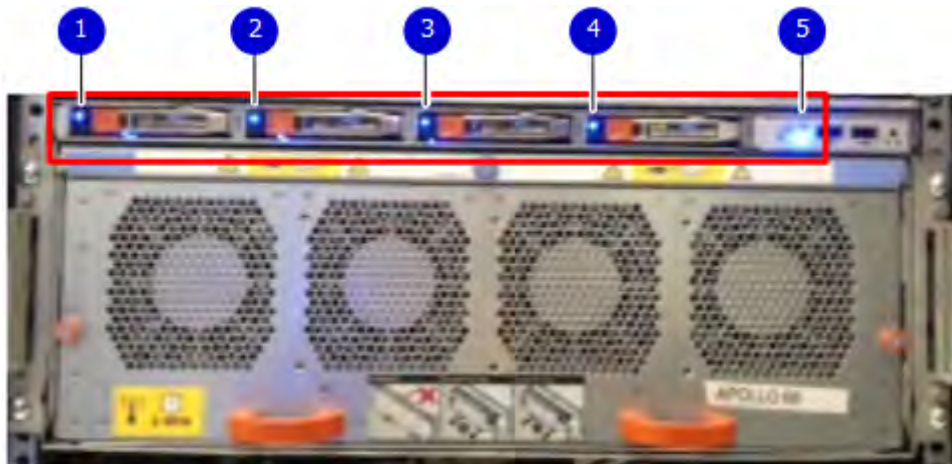
The power button shown in the picture is used when a system needs to be powered up after a shut down using the `system poweroff` command. Once power is restored the system power LED light turns blue.



**Figure 126. Power button**

- 1. System power LED — Blue light indicates system running
- 2. Power button

The LEDs in the front are shown in the following figure.



**Figure 127. Front LEDs**

- 1. SSD LED in slot 0
- 2. SSD LED in slot 1
- 3. SSD LED in slot 2
- 4. SSD LED in slot 3
- 5. System power LED — Blue light indicates system running

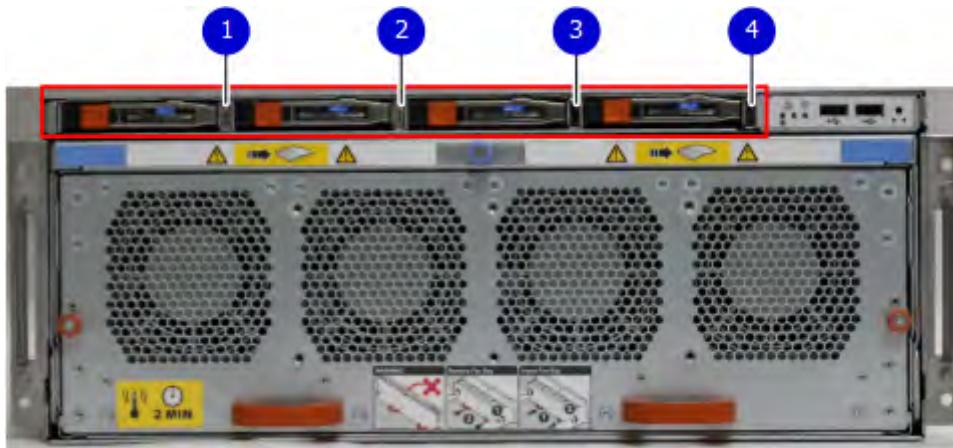
**Table 152. Front panel LED status indicators**

Part	Description or Location	State
System, SP fault	Exclamation point within a triangle	Dark indicates normal operation. Amber indicates failure.
System, chassis fault	Exclamation point within a triangle	Dark indicates normal operation. Amber indicates a fault condition.
SSD	Top LED	Solid blue, disk ready, blinks while busy.
SSD	Bottom LED	Dark indicates healthy. Solid amber indicates disk fail.

## Solid-state drives

A system contains 4 hot-swappable 2.5 in. 400 GB solid-state drives (SSD) located in the front. There are four drive bays numbered 0–3 from left to right. A dual drive failure allows the system to operate without disruption.

Each drive has a blue colored power LED and an amber fault LED.



**Figure 128. SSD drives**

1. Slot 0
2. Slot 1
3. Slot 2
4. Slot 3

# Rear panel

In the rear of the system, the top section contains the 4 power supply units. In the middle of the section, on the left, is serial number tag location. To the right of the serial number tag location is the management module. The lower section contains the NVRAM and the I/O modules numbered 0 through 11 from left to right. The photo shows the hardware features and interfaces on the rear of the system.



**Figure 129. Features on rear of chassis**

- 1. Power supply units
- 2. Serial number tag
- 3. Management module
- 4. NVRAM and I/O modules (slots 0-11)

The figure shows the location of the serial number tag on the left of the management module.



**Figure 130. Serial number tag location**

## Power supply units

A DD9500/DD9800 system has four power supply units, numbered PSU0, PSU1, PSU2, and PSU3 from left to right. Each power supply has its own integral cooling fan.

**NOTE:** The DD9500/DD9800 system should be powered from redundant AC sources. This allows one AC source to fail or be serviced without impacting system operation. PSU0 and PSU1 should be attached to one AC source. PSU2 and PSU3 should be attached to the other AC source.



The AC power plugs are located to the right of each power supply. The wire clips for the AC cords hold the cords in place. The wire clips must be disengaged before disconnecting the AC power to each power supply.



Figure 131. Four power supplies

## Management module

The following figure shows the location of the management module on the rear of the system and identifies the interfaces.

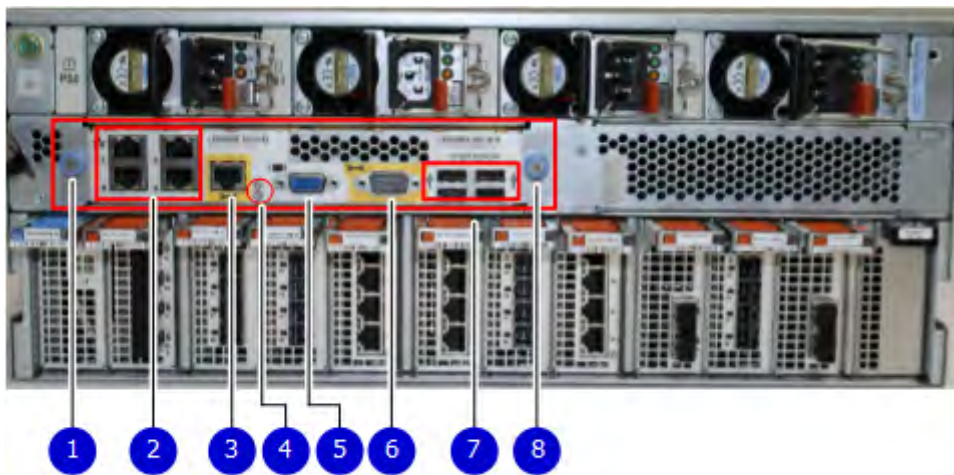
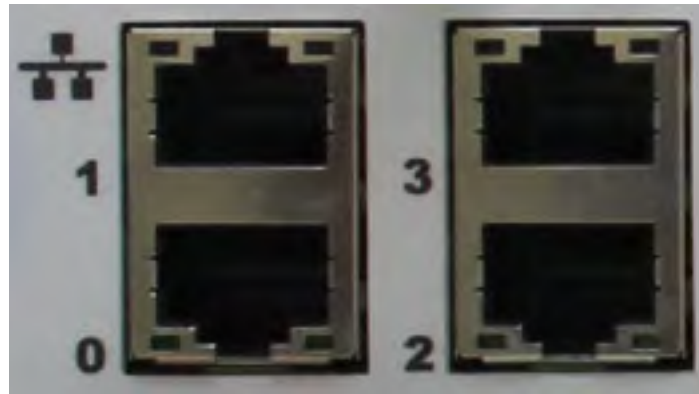


Figure 132. Management module

1. Left blue thumbscrew to loosen the management module
2. 4 x 1000BaseT Ethernet ports (For details, see the picture - 1000BaseT Ethernet ports)
3. Service network port (IPMI, 1000BaseT Ethernet port)
4. Service LED
5. VGA port
6. Serial port
7. Four USB ports
8. Right blue thumbscrew to loosen the management module

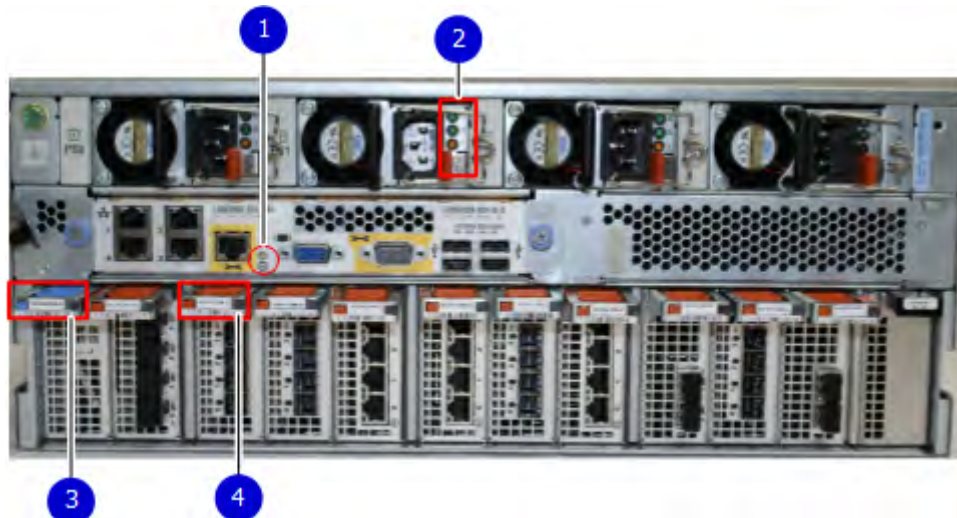


**Figure 133. 1000BaseT Ethernet ports**

- Lower left port: physical #0, logical ethMa
- Top left port: physical #1, logical ethMb
- Lower right port: physical #2, logical ethMc
- Top right port: physical #3, logical ethMd

## Rear LED indicators

The rear elements containing LEDs include each power supply, each I/O module, and the management module. The figure shows the rear LEDs.



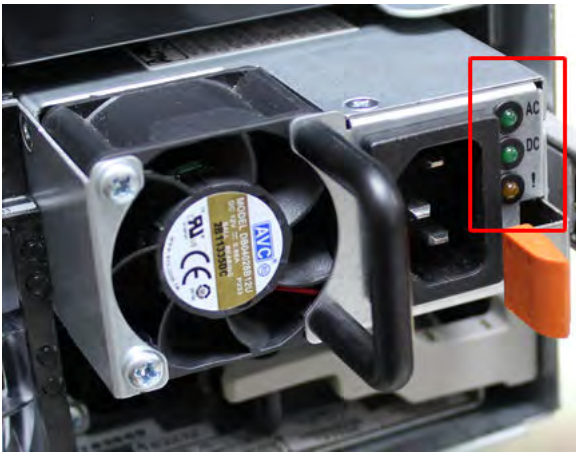
**Figure 134. Rear LEDs**

1. Management module service LEDs
2. Power supply LEDs
3. NVRAM LEDs
4. I/O Module LEDs

The power supply LEDs include:

- AC LED on top
- DC LED in the middle
- Service Required LED on the bottom

**Figure 135. Power supply LEDs**



**Table 153. Rear LED status indicators**

Part	Description or Location	State
Power supply	AC LED	Steady green indicates normal AC input power.
Power supply	DC LED	Steady green indicates normal DC output power.
Power supply	Service LED	Solid amber indicates a failed power supply.
I/O module	I/O module handle	Solid green means I/O module functioning normally. Amber indicates a fault condition. Each I/O module also has per port LEDs. These LEDs are blue on the FC, and SAS I/O modules. They light when the port is active.
Management module	Bicolor LED	Solid green means management module functioning normally. Amber indicates that the management module requires service.

## Available I/O modules

I/O modules may include:

- Quad port Ethernet 10GBase-SR Optical with LC connectors
- Quad port Ethernet 10GBase-CX1 Direct Attach Copper with SPF+ module
- Quad port Ethernet 10GBase-T Copper
- Dual port 16 Gbps Fibre Channel
- Quad port 6 Gbps SAS

## I/O module port physical mapping

I/O module ports are numbered starting with 0. When the I/O modules are inserted vertically into the system chassis, port 0 is on the bottom.

## I/O module port logical mapping

The numerical port labels on the I/O modules are identified logically in the DD OS software by the following descriptions:

- I/O module type
- I/O module slot



- Alphabetic character corresponding to the physical port number

The following example is based on a four-port Ethernet I/O module installed in slot 1 of the system chassis.

**Table 154. Physical to logical port mapping example**

Physical port	Logical identifier
0	eth1a
1	eth1b
2	eth1c
3	eth1d

## Ethernet I/O module options

The available Ethernet I/O modules are:

- Dual Port 10GBase-SR Optical with LC connectors
- Dual Port 10GBase-CX1 Direct Attach Copper with SPF+ module
- Quad Port 1000Base-T Copper with RJ-45 connectors
- Quad port 2 port 1000Base-T Copper (RJ45) /2 port 1000Base-SR Optical

## Fibre Channel I/O modules

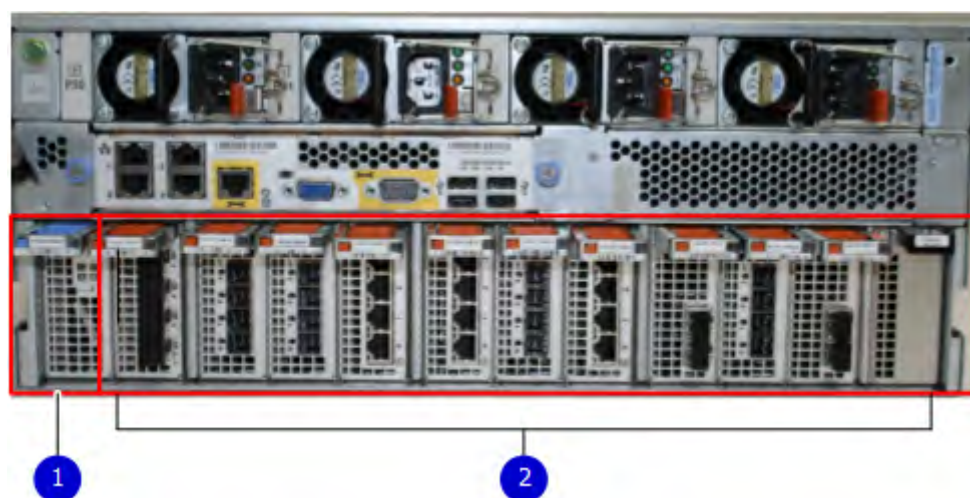
A Fibre Channel (FC) I/O module is a dual-port Fibre Channel module. Up to four FC I/O modules may be installed. The optional virtual tape library (VTL) feature requires at least one FC I/O module. Boost over Fibre Channel is an optional feature and requires at least one FC I/O module. A maximum of four FC I/O modules may be installed in a system using either VTL or the Boost protocol or a combination of both protocols.

## SAS I/O modules

DD9500 systems have three quad-port SAS I/O modules installed in slots 2, 3 and 6. Systems configured with DD Extended Retention (ER) or DD Cloud Tier software options require an additional SAS I/O module in slot 9.

## I/O module slot assignments

The following figure shows the location of the NVRAM and I/O modules.



**Figure 136. Location of NVRAM and I/O modules**

1. NVRAM module—slot 0
2. I/O modules—slots 1 to 11 (See the I/O module slot assignments table.)

The table shows the I/O module slot assignments for the DD9500 system. Each type of I/O module is restricted to certain slots.

**Table 155. DD9500 I/O module slot assignments**

Slot	Base configuration	HA	ER or DD Cloud Tier	DD Cloud Tier and HA
0	NVRAM	NVRAM	NVRAM	NVRAM
1	Fibre Channel (FC), Ethernet or empty	Fibre Channel (FC), Ethernet or empty	Fibre Channel (FC), Ethernet or empty	Fibre Channel (FC), Ethernet or empty
2	SAS	SAS	SAS	SAS
3	SAS	SAS	SAS	SAS
4	FC, Ethernet or empty	FC, Ethernet or empty	FC, Ethernet or empty	FC, Ethernet or empty
5	FC, Ethernet or empty	FC, Ethernet or empty	FC, Ethernet or empty	FC, Ethernet or empty
6	SAS	SAS	SAS	SAS
7	FC, Ethernet or empty	FC, Ethernet or empty	FC, Ethernet or empty	FC, Ethernet or empty
8	FC, Ethernet or empty	FC, Ethernet or empty	FC, Ethernet or empty	FC, Ethernet or empty
9	Not available (contains a filler)	Not available (contains a filler)	SAS	SAS
10	FC, Ethernet or empty	FC, Ethernet or empty	FC, Ethernet or empty	FC, Ethernet or empty
11	FC, Ethernet or empty	10 Gb optical Ethernet for interconnect between the primary and standby nodes in the HA pair.	FC, Ethernet or empty	10 Gb optical Ethernet for interconnect between the primary and standby nodes in the HA pair.

## Slot addition rules

This system has 12 slots for I/O modules. Slots 0, 2, 3, 6, 9, and 11 are reserved for mandatory I/O modules. Slots 1, 4, 5, 7, 8, and 10 support optional host interface I/O modules. The maximum supported number of any type of host interface (Ethernet or FC) I/O module is four.

**i NOTE:** The maximum number of host interface I/O modules that are listed above does not include the 10 GbE Optical I/O module for the HA interconnect. The HA interconnect is a fifth Ethernet module, but it is reserved for communication between the two nodes of an HA pair, and is not available for host connections.

The maximum number of I/O modules, including both mandatory and optional I/O modules, supported in a system varies by configuration:

- Single node: 10
- HA: 10
- DD Extended Retention: 10
- DD Cloud Tier: 10
- HA + DD Cloud Tier: 11

Three I/O module slots are tied to each CPU in the system. When installing I/O modules, balance the load across the CPUs. The following table shows the CPU to slot mappings.

CPU	I/O module slots
0	0, 1, 2

CPU	I/O module slots
1	3, 4, 5
2	6, 7, 8
3	9, 10, 11

The following table assigns rules for populating the I/O modules.

**Table 156. I/O module slot population rules**

Step	I/O module type	Slots	Notes
1: Populate mandatory I/O modules	NVRAM	0	
	Quad Port SAS	2	
	Quad Port SAS	3	
	Quad Port SAS	6	
	Quad Port SAS	9	This slot remains empty if the system does not use DD Cloud Tier or DD Extended Retention.
	Quad Port 10GbE Optical	11	This slot remains empty if the system does not use HA.
2: Populate host interface I/O modules	<ul style="list-style-type: none"> <li>Quad Port 10GbE SR</li> <li>Quad Port 10 GBase-T</li> <li>Dual Port 16 Gbps Fibre Channel</li> </ul>	1, 4, 5, 7, 8, 10	Install host interface I/O modules in the remaining slots. Install the I/O modules to balance the load across the CPUs. Do not place two Ethernet or two FC I/O modules on one CPU. <sup>a</sup>

a. HA systems are the exception to this guidance, as a Quad Port 10GbE SR I or Quad Port 10 GBase-T /O module can be added in slot 10 alongside the HA interconnect I/O module in slot 11.

## Internal System Components

The storage processor (SP) is a subassembly within the chassis that contains the memory risers with the DIMMs and a fan tray with fan modules. The SP module also contains the 4 CPUs, which cannot be removed or replaced.

- The memory risers tray, which contains 8 memory risers with DIMMs, can be accessed from the front of the SP module. The memory risers are not hot swappable
- The fan tray, which contains 8 fan modules, can be accessed from the front of the SP module. The fans are hot swappable.

The DIMMS can be accessed by pulling the entire SP module away from the chassis. Depending on the model, there are DIMMs totaling:

- 256 GB or 512 GB for a DD9500 system.
- 256 GB or 768 GB for a DD9800 system.

The figures show the location of the SP module, the DIMM risers accessed from a partly removed SP module, and the fan tray partly removed.

Do not lift the DD9500/DD9800 system, or the storage processor (SP) module, or any modules by the handle. The handle is not designed to support the weight of the populated shelf. Also do not carry the DD9500/DD9800 system or the SP by the handle. The handles are only intended to be used to insert or remove the SP module.



Figure 137. SP module



Figure 138. Releasing a memory riser

1. Left riser card ejector handle
2. Release button
3. Right riser card ejector handle



**Figure 139. Open fan tray**

**NOTE:** Do not loosen the blue thumbscrew on the SP latch handle to access the fan tray. Use the orange thumbscrews on the front as shown in the picture.

1. Left fan tray thumbscrew
2. Front panel left handle
3. Front panel right handle
4. Right fan tray thumbscrew
5. Location map of the fans

## DIMM modules

The DD9500 system contains the following memory configurations:

**Table 157. DD9500 memory configurations**

System	Base	Expanded	ER/DD Cloud Tier
DD9500	32 x 8 GB DIMMs (256 GB)	32 x 8 GB DIMMs + 16 x 16 GB DIMMs (512 GB)	32 x 8 GB DIMMs + 16 x 16 GB DIMMs (512 GB)

## Cooling fans

A system contains eight hot-swappable cooling fans in a 7+1 redundant configuration, which is located in the front of the system within a movable fan tray. The fans provide cooling for the processors, DIMMs, and I/O modules. Each fan has an LED which glows amber when the fan is failed or faulted. A system can run with one fan faulted.

## DD9500 and ES30 shelf guidelines

The system rediscovers newly configured shelves after it restarts. You can power off the system and recable shelves to any other position in a set, or to another set. To take advantage of this flexibility, you need to follow these rules before making any cabling changes:

- Do not exceed the maximum shelf configuration values for your system as listed in the following table below.
- Use the Installation and Setup Guide for your system to minimize the chance of a cabling mistake.
- A system cannot exceed its maximum raw external shelf capacity, regardless of added shelf capacity.

- DD9500 systems support ES30 SATA shelves after controller upgrades from older models.
- ES30 SATA shelves must be on their own chain.

**Table 158. DD9500 and ES30 shelf configuration**

DD system	Memory required (GB)	SAS cards/port per card	ES30 support (TB)	Max shelves per set	Max number of sets	Max external capacity available (TB) <sup>1</sup>	Max RAW external capacity (TB) <sup>2</sup>
DD9500	256	3x4	SAS 30, 45, 60; SATA 15, 30, 45	5 <sup>3</sup>	6	432	540
DD9500	512	3x4	SAS 30, 45, 60; SATA 15, 30, 45	5 <sup>3</sup>	6	864	1080
DD9500 ER <sup>4, 5</sup>	512	4x4	SAS 30, 45, 60; SATA 15, 30, 45	7	8	1728	2160
DD9500 HA <sup>6, 7</sup>	256	3x4	SAS 30, 45, 60	5 <sup>3</sup>	6	432	540
DD9500 HA <sup>6, 7</sup>	512	3x4	SAS 30, 45, 60	5 <sup>3</sup>	6	864	1080
DD9500 w/ Cloud Tier	512	4x4	SAS 30, 45, 60; SATA 15, 30, 45	7	8	864 (max), additional 240 SAS dedicated to Cloud Tier	1080 (max), additional 300 SAS dedicated to Cloud Tier
DD9500 w/ HA and Cloud Tier	512	4x4	SAS 30, 45, 60	7	8	864 (max), additional 240 SAS dedicated to Cloud Tier	1080 (max), additional 300 SAS dedicated to Cloud Tier

1. This figure only counts drives that have user data in the shelves.

2. The raw capacity of an ES30 is 125% of the available capacity.

4. 5 shelves maximum with ES30, 4 is the recommended maximum. 4 shelves maximum with ES20, 3 is the recommended maximum.

5. The maximum shelf count for any specific drive/shelf size might be less than the product of max shelves x max shelves per set.

6. There is no support for ERSO on HA systems.

7. There is no support for HA with SATA drives.

## Types of cabinets and power connections

The ES30 chassis is installed in two types of racks: 40U-C (existing racks) and the 40U-P (newer racks). The racks use one phase or 3-phase power connections.

### 3-Phase power connections for 40U-P (current racks)

Some environments use 3-phase power for 40U-P racks that are used for several systems. In those situations, it is desirable to balance the current draw across all three phases. The recommended 3-phase power cabling attempts to do that, but an optimal configuration depends on the specific installation.



## Cabling shelves

### **NOTE:**

- Before cabling the shelves, physically install all shelves in the racks. Refer to the rail kit installation instructions included with the ES30 shelf for rack mounting.
- The documentation refers to two SAS HBAs. If only one HBA is allowed in a system, then use another port as defined later for that specific system.
- On an HA system, add cables from the second node to open ports at the end of the sets. The ports on the second node must connect to the same sets as the corresponding ports on the first node.

Ports on the system's SAS HBA cards connect directly to a shelf controller's host port. For redundancy, you need to create dual paths by using a port on one SAS HBA card to connect to one shelf controller in each shelf set, and a port on another SAS HBA card to connect to another shelf controller in the same shelf set. With dual paths, if one SAS HBA card fails, the shelf is still operational. However, in the unlikely event any single shelf becomes completely disconnected from power or SAS cables and becomes disconnected from a previously operational shelf, the file system goes down and the shelf is not operational. This is considered a double failure.

There are two kinds of configurations: one shelf in a set or multiple shelves in a set.

## DD9500 and cabling

**NOTE:** If a system installation does not follow ALL of these rules, it is not a legitimate configuration.

Prerequisites:

- Follow the minimum and maximum shelf capacity configuration provided in the table.
- You cannot have ES30 SATA and ES30 SAS shelves in the same set.
- You cannot exceed the maximum amount of raw capacity displayed in the product's cabling table.
- You cannot exceed the maximum number of shelves displayed in the product's cabling table.
- You cannot have more than five ES30s in a single set (maximum of four is preferred).
- You can have seven ES30s for systems with Extended Retention software.
- There are no specific placement or cabling requirements for SSD shelves, or the metadata shelves for Cloud Tier configurations. These shelves can be installed and cabled the same way as standard ES30 shelves.

**Table 159. Minimum and maximum configurations**

System	DD9500	DD9500 w/	
Appliance	864 TB usable	864 TB usable	1008 TB usable
Minimum appliance shelf count	4	4	4
Maximum appliance shelf count	30	30	30
Extended Retention systems (ER)	1728 TB usable	2016 TB usable	2016 TB usable
Maximum shelves for ER	56	56	56
High Availability systems (HA)	864 TB usable	1008 TB usable	1008 TB usable
Maximum shelves for HA	42	42	47
Cloud Tier systems	1104 TB usable	1248 TB usable	1248 TB usable
Maximum shelves for Cloud Tier	42	42	47

The DD9500 base (non-Extended Retention) and HA systems supports six chains.

The following figures show cabling for base systems, HA systems, and systems with the Extended Retention software option.

**NOTE:** The racks are filled from bottom up.

## DD9500 and DS60 shelf guidelines

The system rediscovers newly configured shelves after it restarts. You can power off the system and recable shelves to any other position in a set, or to another set. To take advantage of this flexibility, you need to follow these rules before making any cabling changes:

- Do not exceed the maximum shelf configuration values for your system as listed in the following table.
- For redundancy, the two connections from a system to a set of shelves must use ports on different SAS I/O modules.
- Use the Installation and Setup Guide for your system to minimize the chance of a cabling mistake.
- A system cannot exceed its maximum raw external shelf capacity, regardless of added shelf capacity.
- ES30 SATA shelves must be on their own chain.
- If ES30 SAS shelves are on the same chain as a DS60, the maximum number of shelves on that chain is 5.

**Table 160. DD9500 and DS60 shelf configuration**

DD system	Memory required (GB)	SAS cards/port per card	DS60 support (TB)	Max shelves per set	Max number of sets	Max external capacity available (TB) <sup>1</sup>	Max RAW external capacity (TB)
DD9500	256	3x4	SAS 45, 60	4	6	432	540
DD9500 Expanded	512	3x4	SAS 45, 60	4	6	864	1080
DD9500 ER	512	4x4	SAS 45, 60	4	8	1728	2160
DD9500 HA <sup>2</sup>	512	3x4	SAS 45, 60	4	6	864	1080
DD9500 Cloud Tier <sup>3,4</sup>	512	4x4	SAS 45, 60	4	8	864 + 240 for Cloud Tier	1080 + 300 for Cloud Tier
DD9500 Cloud Tier w/ HA <sup>3,4</sup>	512	4x4	SAS 45, 60	4	8	864 + 240 for Cloud Tier	1080 + 300 for Cloud Tier

**NOTE:** An entry of 45 corresponds to DS60-3 models and an entry of 60 corresponds to DS60-4 models.

1. This column only counts drives that have user data in the shelves. For example, a DS60 4-240 has 192TB.
2. DD9300 base support 2.5 DS60-4 180 x 2 plus DS60-2 90, if a half-filled DS60 is necessary.
3. DD9300 Expanded supports five DS60 maximum.
4. There is no support for HA with SATA drives.

## 3-phase power connections for 40U-P (current racks)

Some environments use 3-phase power for 40U-P racks used for several systems. In those situations it is desirable to balance the current draw across all 3 phases. The recommended 3-phase power cabling attempts to do that, but an optimal configuration is dependent on the specific installation.

## DD9500 and DD9800 cabling

**NOTE:** If a system installation does not follow ALL of these rules, it is not a legitimate configuration.

Prerequisites:

- Follow the minimum and maximum shelf capacity configuration provided in the table.
- You cannot have ES30 SATA and ES30 SAS shelves in the same set.
- You cannot exceed the maximum amount of raw capacity displayed in the product's cabling table.
- You cannot exceed the maximum number of shelves displayed in the product's cabling table.


- You cannot have more than five ES30s in a single set (maximum of four is preferred).
- You can have seven ES30s for systems with Extended Retention software.
- There are no specific placement or cabling requirements for SSD shelves, or the metadata shelves for Cloud Tier configurations. These shelves can be installed and cabled the same way as standard ES30 shelves.

**Table 161. Minimum and maximum configurations**

System	DD9500	DD9500 w/	
Appliance	864 TB usable	864 TB usable	1008 TB usable
Minimum appliance shelf count	4	4	4
Maximum appliance shelf count	30	30	30
Extended Retention systems (ER)	1728 TB usable	2016 TB usable	2016 TB usable
Maximum shelves for ER	56	56	56
High Availability systems (HA)	864 TB usable	1008 TB usable	1008 TB usable
Maximum shelves for HA	42	42	47
Cloud Tier systems	1104 TB usable	1248 TB usable	1248 TB usable
Maximum shelves for Cloud Tier	42	42	47

The DD9500 base (non-Extended Retention) and HA systems supports six chains.

The following figures show cabling for base systems, HA systems, and systems with the Extended Retention software option.

 **NOTE:** The racks are filled from bottom up.

## DD9800

This chapter contains the following topics:

**Topics:**

- [DD9800 system features](#)
- [DD9800 system specifications](#)
- [DD9800 storage capacity](#)
- [DD9800 front panel](#)
- [Rear panel](#)
- [I/O module slot assignments](#)
- [Internal system components](#)
- [DD9800 and ES30 shelf guidelines](#)
- [DD9800 and DS60 shelf guidelines](#)

# DD9800 system features

Table 162. DD9800 system features

Feature		DD9800 (Base configuration)	DD9800 (Expanded configuration)
Rack height		4U, supported in four-post racks only	4U, supported in four-post racks only
Rack mounting		Rack mount kit included with each system. Adjustable between 24 - 36 in. (60.9–76.2 cm).	Rack mount kit included with each system. Adjustable between 24 - 36 in. (60.9–76.2 cm).
Power		4 hot-swappable power units, 2 pairs of 1 +1 redundant	4 hot-swappable power units, 2 pairs of 1 +1 redundant
Voltage		200–240 V~. Frequency: 50 Hz to 60 Hz.	200–240 V~. Frequency: 50 Hz to 60 Hz.
Processor		4 Intel EX processors.	4 Intel EX processors.
NVRAM		One 8-GB NVRAM module for data integrity during a power outage	One 8-GB NVRAM module for data integrity during a power outage
Fans		8 hot-swappable fans, redundant	8 hot-swappable fans, redundant
Memory		32 x 8 GB DIMM (256 GB)	32 x 8 GB DIMM + 32 x 16 GB DIMM (768 GB)
Internal drives		4 x 400 GB (base 10) hot-swappable solid state drives (SSD)	4 x 400 GB (base 10) hot-swappable solid state drives (SSD)
I/O module slots		11 I/O module (Fibre Channel, Ethernet, and SAS) slots. Replaceable I/O modules are not hot-swappable. See <a href="#">I/O module slot assignments</a> on page 243	11 I/O module (Fibre Channel, Ethernet, and SAS) slots. Replaceable I/O modules are not hot-swappable. See <a href="#">I/O module slot assignments</a> on page 243
Supported capacity	Non-extended retention	630 TB	1260 TB
	DD Cloud Tier	N/A	2520 TB <sup>a</sup>
	Extended retention	N/A	1260 TB <sup>b</sup>
High availability support		Yes	Yes
HA private interconnect		4 10 GbE optical ports	4 10 GbE optical ports
External SSD shelf		1 x 8 drive SSD shelf	1 x 15 drive SSD shelf

- a. DD Cloud Tier requires five ES30 shelves fully populated with 4 TB drives to store DD Cloud Tier metadata.
- b. Extended retention not available on HA configurations

# DD9800 system specifications

Table 163. DD9800 system specifications

Model	Watts	BTU/hr	Power (VA)	Weight	Width	Depth	Height
DD9800	1887	6444	1981	117 lb / 53.2 kg	19 in / 48.3 cm	29.5 in / 74.9 cm	7 in / 17.8 cm

- Operating temperature: 50° to 95° F (10° to 35° C), derate 1.1° C per 1000 feet, above 7500 feet up to 10,000 feet
- Operating humidity: 20% to 80%, non-condensing
- Non-operating temperature: -40° to +149° F (-40° to +65° C)
- Operating acoustic noise: Sound power, LWAd, is 7.7 bels.



## DD9800 storage capacity

The table lists the capacities of the systems. The internal indexes and other product components use variable amounts of storage, depending on the type of data and the sizes of files. If you send different datasets to otherwise identical systems, one system may, over time, have room for more or less actual backup data than another.

**NOTE:** System commands compute and display amounts of disk space or data as decimal multiples of certain powers of two ( $2^{10}$ ,  $2^{20}$ ,  $2^{30}$ , and so forth). For example, 7 GB of disk space =  $7 \times 2^{30}$  bytes =  $7 \times 1,073,741,824$  bytes. The system sees this process as Base 2 calculation.

**Table 164. DD9800 storage capacity**

System/ Installed Memory	Internal Disks	Raw Storage (Base 10)	Data Storage Space (Base 2 Calculation)	Data Storage Space (Base 10 Calculation)
DD9800 (3 SAS I/O modules) 256 GB	2.5 in.; 4 x 400 GB SATA SSD  No User Data	630 TB (external)	457.8 TiB	504 TB
DD9800 (3 SAS I/O modules) 768 GB	2.5 in.; 4 x 400 GB SATA SSD  No User Data	1,260 TB (external)	915.6 TiB	1,008 TB
DD9800 with DD Cloud Tier (4 SAS I/O modules) 768 GB	2.5 in.; 4 x 400 GB SATA SSD  No User Data	3,780 TB (external)	2746.8 TiB	3,024 TB
DD9800 with ER (4 SAS I/O modules) 768 GB	2.5 in.; 4 x 400 GB SATA SSD  No User Data	2,520 TB (external)	1,831.2 TiB	2,016 TB

**Table 165. DD9800 with ES30 SAS shelves**

	DD9800	DD9800
Memory (GB)	256	768
SAS I/O modules x ports per module	3x4	3x4
ES30 support (TB)	SAS 30, 45, 60	SAS 30, 45, 60
Maximum shelves per set	5	5
Maximum number of sets	6	6

**NOTE:** ES30 SATA shelves are supported when upgrading from an older single node system, but are not supported with HA pairs or new installations.

**Table 166. DD9800 with DS60 shelves**

	DD9800	DD9800
Memory (GB)	256	768
SAS I/O modules x ports per module	3x4	3x4
DS60 support (TB)	SAS 45, 60	SAS 45, 60
Maximum shelves per set	4	4
Maximum number of sets	6	6

# DD9800 front panel

The four solid state drives (SSDs), the storage processor (SP), and the fans are accessed from the front of the system. The SP must be pulled out to provide access to the DIMMs. The fans are accessed without pulling or removing the SP and they are hot-swappable. The photo shows the interfaces on the front of the system.

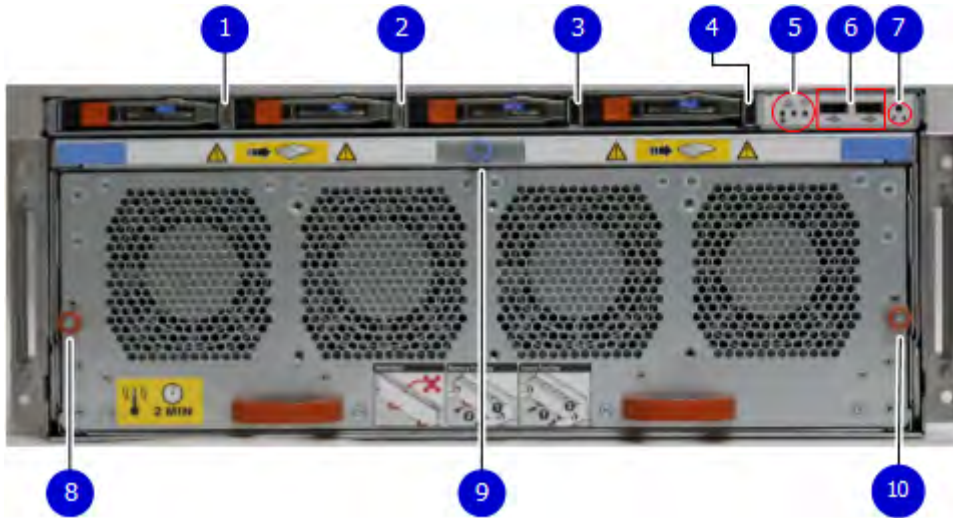


Figure 140. Front panel components

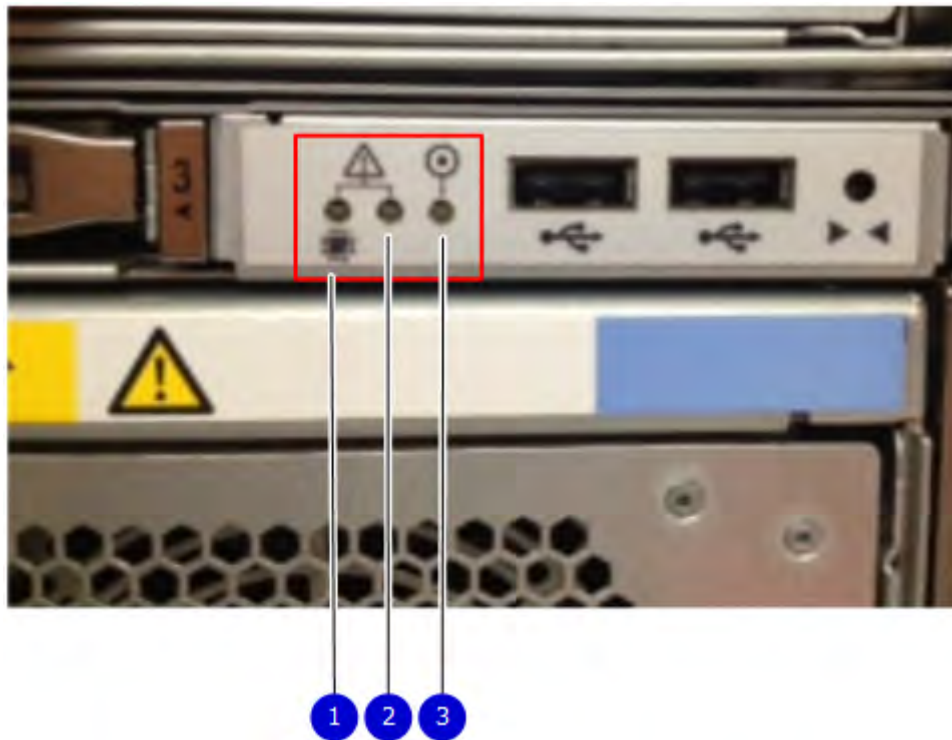
1. SSD slot 0
2. SSD slot 1
3. SSD slot 2
4. SSD slot 3
5. Front LEDs
6. USB ports
7. Power button
8. Fan tray thumbscrew (left)
9. SP module thumbscrew to secure the ejector handle
10. Fan tray thumbscrew (right)

## Front LED indicators

On the front panel to the right of SSD #4 (in Slot 3) are 3 LEDs that show high level system status. The System Power LED glows blue to show the system is powered on.

**NOTE:** The system can have power (be plugged in) but the blue LEDs are off if the system is powered off.

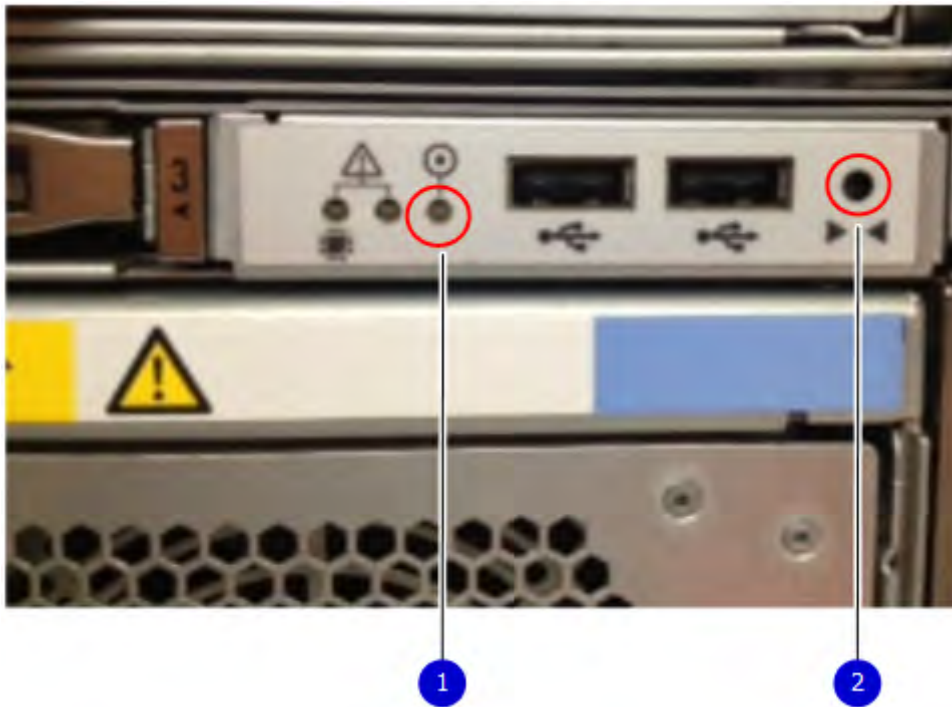
The SP Service LED is normally off, but glows amber whenever the storage processor (SP) requires service. The Enclosure Service LED is normally off, but glows amber whenever the SP or other replaceable parts require service. The System Power and Enclosure Service LEDs are visible through the front bezel.



**Figure 141. Service LEDs**

1. SP service LED — Amber light indicates that the SP or one of its components needs service.
2. Enclosure Service LED — This is normally off, but amber light indicates that the enclosure or something within the enclosure— the fans, SP, I/O modules, management module etc—requires service.
3. System power LED — Blue light indicates system running

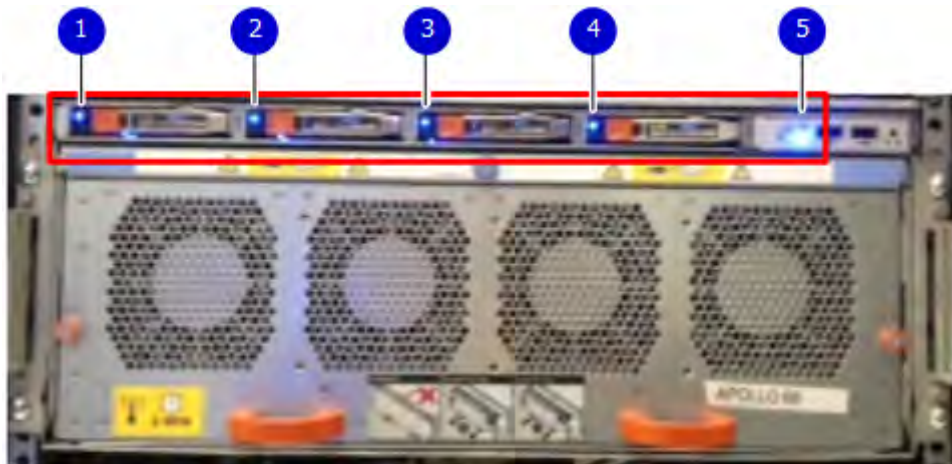
The power button shown in the picture is used when a system needs to be powered up after a shut down using the `system poweroff` command. Once power is restored the system power LED light turns blue.



**Figure 142. Power button**

- 1. System power LED — Blue light indicates system running
- 2. Power button

The LEDs in the front are shown in the following figure.



**Figure 143. Front LEDs**

- 1. SSD LED in slot 0
- 2. SSD LED in slot 1
- 3. SSD LED in slot 2
- 4. SSD LED in slot 3
- 5. System power LED — Blue light indicates system running

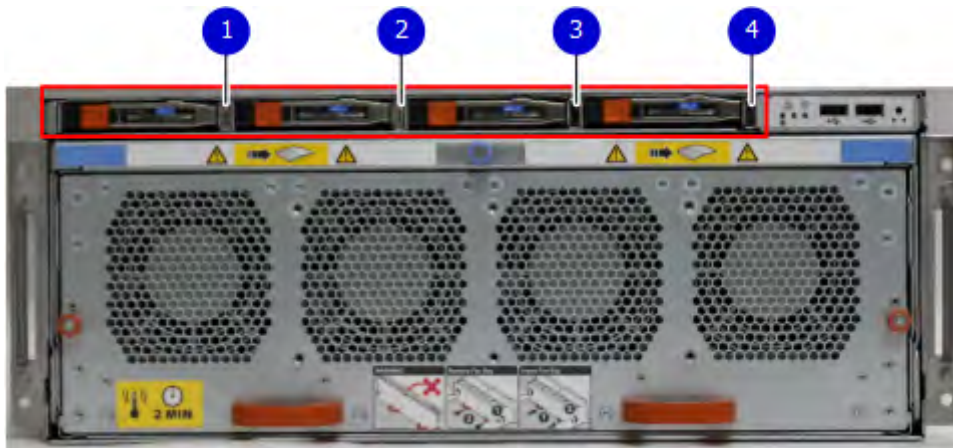
**Table 167. Front panel LED status indicators**

Part	Description or Location	State
System, SP fault	Exclamation point within a triangle	Dark indicates normal operation. Amber indicates failure.
System, chassis fault	Exclamation point within a triangle	Dark indicates normal operation. Amber indicates a fault condition.
SSD	Top LED	Solid blue, disk ready, blinks while busy.
SSD	Bottom LED	Dark indicates healthy. Solid amber indicates disk fail.

## Solid-state drives

A system contains 4 hot-swappable 2.5 in. 400 GB solid-state drives (SSD) located in the front. There are four drive bays numbered 0–3 from left to right. A dual drive failure allows the system to operate without disruption.

Each drive has a blue colored power LED and an amber fault LED.



**Figure 144. SSD drives**

1. Slot 0
2. Slot 1
3. Slot 2
4. Slot 3



## Rear panel

In the rear of the system, the top section contains the 4 power supply units. In the middle of the section, on the left, is serial number tag location. To the right of the serial number tag location is the management module. The lower section contains the NVRAM and the I/O modules numbered 0 through 11 from left to right. The photo shows the hardware features and interfaces on the rear of the system.



Figure 145. Features on rear of chassis

1. Power supply units
2. Serial number tag
3. Management module
4. NVRAM and I/O modules (slots 0-11)

The figure shows the location of the serial number tag on the left of the management module.



Figure 146. Serial number tag location

## Power supply units

A DD9800 system has four power supply units, numbered PSU0, PSU1, PSU2, and PSU3 from left to right. Each power supply has its own integral cooling fan.

**NOTE:** The DD9800 system should be powered from redundant AC sources. This allows one AC source to fail or be serviced without impacting system operation. PSU0 and PSU1 should be attached to one AC source. PSU2 and PSU3 should be attached to the other AC source.

The AC power plugs are located to the right of each power supply. The wire clips for the AC cords hold the cords in place. The wire clips must be disengaged before disconnecting the AC power to each power supply.



Figure 147. Four power supplies

## Management module

The following figure shows the location of the management module on the rear of the system and identifies the interfaces.

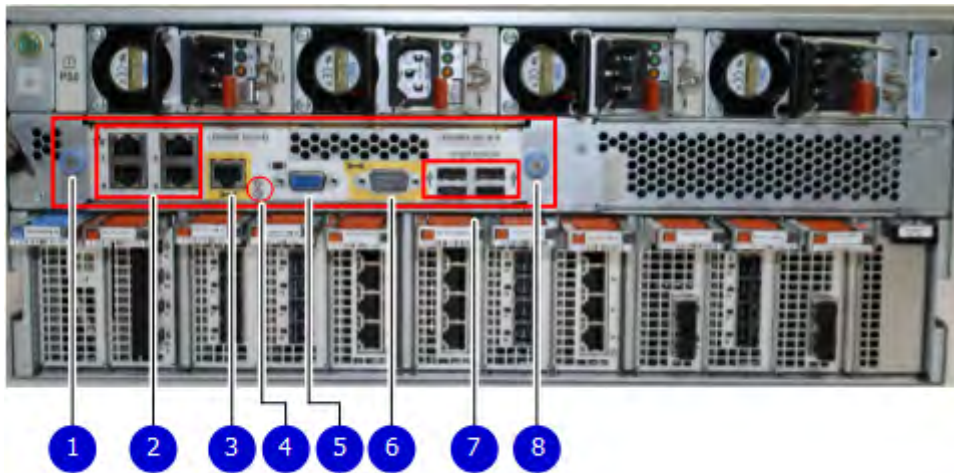
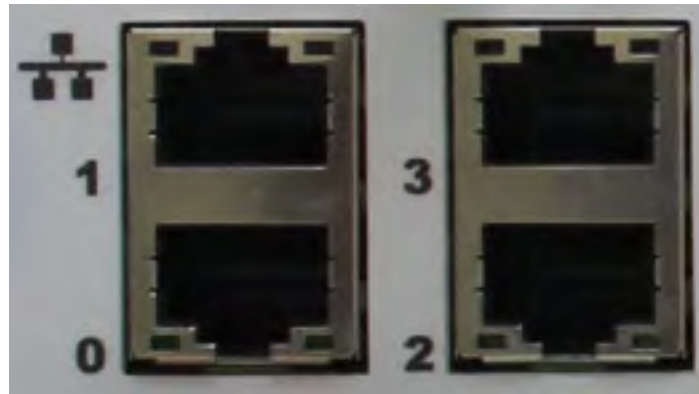


Figure 148. Management module

1. Left blue thumbscrew to loosen the management module
2. 4 x 1000BaseT Ethernet ports (For details, see the picture - 1000BaseT Ethernet ports)
3. Service network port (IPMI, 1000BaseT Ethernet port)
4. Service LED
5. VGA port
6. Serial port
7. Four USB ports
8. Right blue thumbscrew to loosen the management module



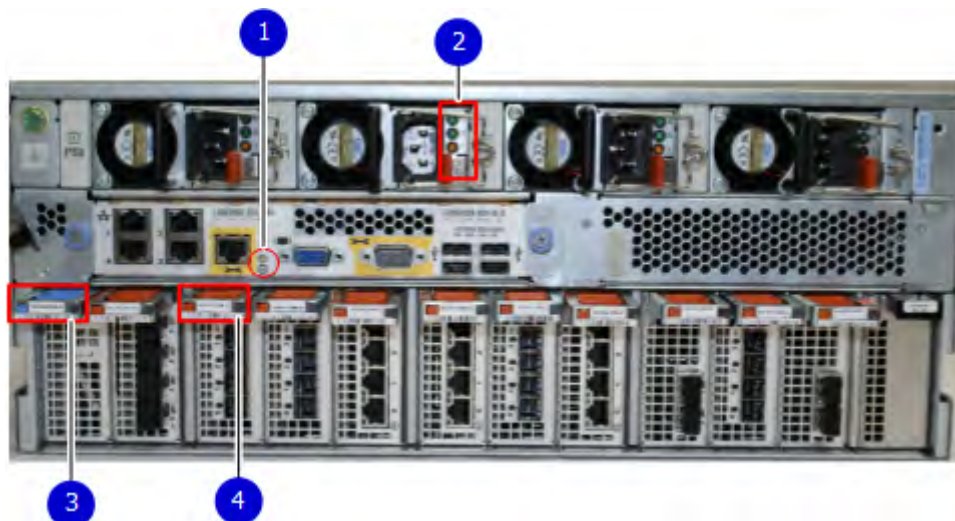


**Figure 149. 1000BaseT Ethernet ports**

- Lower left port: physical #0, logical ethMa
- Top left port: physical #1, logical ethMb
- Lower right port: physical #2, logical ethMc
- Top right port: physical #3, logical ethMd

## Rear LED indicators

The rear elements containing LEDs include each power supply, each I/O module, and the management module. The figure shows the rear LEDs.



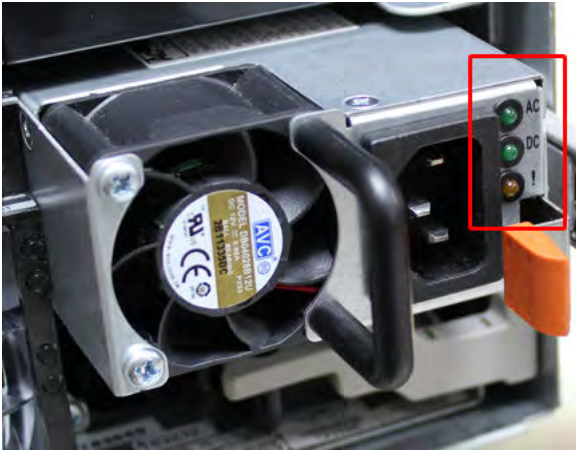
**Figure 150. Rear LEDs**

1. Management module service LEDs
2. Power supply LEDs
3. NVRAM LEDs
4. I/O Module LEDs

The power supply LEDs include:

- AC LED on top
- DC LED in the middle
- Service Required LED on the bottom

**Figure 151. Power supply LEDs**



**Table 168. Rear LED status indicators**

Part	Description or Location	State
Power supply	AC LED	Steady green indicates normal AC input power.
Power supply	DC LED	Steady green indicates normal DC output power.
Power supply	Service LED	Solid amber indicates a failed power supply.
I/O module	I/O module handle	Solid green means I/O module functioning normally. Amber indicates a fault condition. Each I/O module also has per port LEDs. These LEDs are blue on the FC, and SAS I/O modules. They light when the port is active.
Management module	Bicolor LED	Solid green means management module functioning normally. Amber indicates that the management module requires service.

## Available I/O modules

I/O modules may include:

- Quad port Ethernet 10GBase-SR Optical with LC connectors
- Quad port Ethernet 10GBase-CX1 Direct Attach Copper with SPF+ module
- Quad port Ethernet 10GBase-T Copper
- Dual port 16 Gbps Fibre Channel
- Quad port 6 Gbps SAS

### I/O module port physical mapping

I/O module ports are numbered starting with 0. When the I/O modules are inserted vertically into the system chassis, port 0 is on the bottom.

### I/O module port logical mapping

The numerical port labels on the I/O modules are identified logically in the DD OS software by the following descriptions:

- I/O module type
- I/O module slot

- Alphabetic character corresponding to the physical port number

The following example is based on a four-port Ethernet I/O module installed in slot 1 of the system chassis.

**Table 169. Physical to logical port mapping example**

Physical port	Logical identifier
0	eth1a
1	eth1b
2	eth1c
3	eth1d

## Ethernet I/O module options

The available Ethernet I/O modules are:

- Dual Port 10GBase-SR Optical with LC connectors
- Dual Port 10GBase-CX1 Direct Attach Copper with SPF+ module
- Quad Port 1000Base-T Copper with RJ-45 connectors
- Quad port 2 port 1000Base-T Copper (RJ45) /2 port 1000Base-SR Optical

## Fibre Channel I/O modules

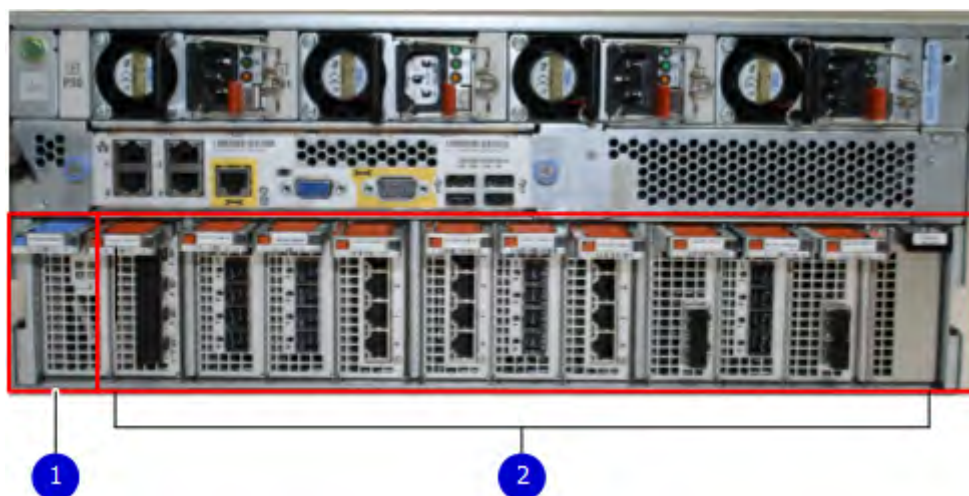
A Fibre Channel (FC) I/O module is a dual-port Fibre Channel module. Up to four FC I/O modules may be installed. The optional virtual tape library (VTL) feature requires at least one FC I/O module. Boost over Fibre Channel is an optional feature and requires at least one FC I/O module. A maximum of four FC I/O modules may be installed in a system using either VTL or the Boost protocol or a combination of both protocols.

## SAS I/O modules

DD9800 systems have three quad-port SAS I/O modules installed in slots 2, 3 and 6. Systems configured with DD Extended Retention (ER) or DD Cloud Tier software options require an additional SAS I/O module in slot 9.

## I/O module slot assignments

The following figure shows the location of the NVRAM and I/O modules.



**Figure 152. Location of NVRAM and I/O modules**

1. NVRAM module—slot 0
2. I/O modules—slots 1 to 11 (See the I/O module slot assignments table.)

The table shows the I/O module slot assignments for the DD9800 system. Each type of I/O module is restricted to certain slots.

**Table 170. DD9800 I/O module slot assignments**

Slot	Base configuration	HA	ER or DD Cloud Tier	DD Cloud Tier and HA
0	NVRAM	NVRAM	NVRAM	NVRAM
1	Fibre Channel (FC), Ethernet or empty	Fibre Channel (FC), Ethernet or empty	Fibre Channel (FC), Ethernet or empty	Fibre Channel (FC), Ethernet or empty
2	SAS	SAS	SAS	SAS
3	SAS	SAS	SAS	SAS
4	FC, Ethernet or empty	FC, Ethernet or empty	FC, Ethernet or empty	FC, Ethernet or empty
5	FC, Ethernet or empty	FC, Ethernet or empty	FC, Ethernet or empty	FC, Ethernet or empty
6	SAS	SAS	SAS	SAS
7	FC, Ethernet or empty	FC, Ethernet or empty	FC, Ethernet or empty	FC, Ethernet or empty
8	FC, Ethernet or empty	FC, Ethernet or empty	FC, Ethernet or empty	FC, Ethernet or empty
9	Not available (contains a filler)	Not available (contains a filler)	SAS	SAS
10	FC, Ethernet or empty	FC, Ethernet or empty	FC, Ethernet or empty	FC, Ethernet or empty
11	FC, Ethernet or empty	10 Gb optical Ethernet for interconnect between the primary and standby nodes in the HA pair.	FC, Ethernet or empty	10 Gb optical Ethernet for interconnect between the primary and standby nodes in the HA pair.

## Slot addition rules

This system has 12 slots for I/O modules. Slots 0, 2, 3, 6, 9, and 11 are reserved for mandatory I/O modules. Slots 1, 4, 5, 7, 8, and 10 support optional host interface I/O modules. The maximum supported number of any type of host interface (Ethernet or FC) I/O module is four.

**i NOTE:** The maximum number of host interface I/O modules that are listed above does not include the 10 GbE Optical I/O module for the HA interconnect. The HA interconnect is a fifth Ethernet module, but it is reserved for communication between the two nodes of an HA pair, and is not available for host connections.

The maximum number of I/O modules, including both mandatory and optional I/O modules, supported in a system varies by configuration:

- Single node: 10
- HA: 10
- DD Extended Retention: 10
- DD Cloud Tier: 10
- HA + DD Cloud Tier: 11

Three I/O module slots are tied to each CPU in the system. When installing I/O modules, balance the load across the CPUs. The following table shows the CPU to slot mappings.

CPU	I/O module slots
0	0, 1, 2

CPU	I/O module slots
1	3, 4, 5
2	6, 7, 8
3	9, 10, 11

The following table assigns rules for populating the I/O modules.

**Table 171. I/O module slot population rules**

Step	I/O module type	Slots	Notes
1: Populate mandatory I/O modules	NVRAM	0	
	Quad Port SAS	2	
	Quad Port SAS	3	
	Quad Port SAS	6	
	Quad Port SAS	9	This slot remains empty if the system does not use DD Cloud Tier or DD Extended Retention.
	Quad Port 10GbE Optical	11	This slot remains empty if the system does not use HA.
2: Populate host interface I/O modules	<ul style="list-style-type: none"> <li>Quad Port 10GbE SR</li> <li>Quad Port 10 GBase-T</li> <li>Dual Port 16 Gbps Fibre Channel</li> </ul>	1, 4, 5, 7, 8, 10	Install host interface I/O modules in the remaining slots. Install the I/O modules to balance the load across the CPUs. Do not place two Ethernet or two FC I/O modules on one CPU. <sup>a</sup>

a. HA systems are the exception to this guidance, as a Quad Port 10GbE SR I or Quad Port 10 GBase-T /O module can be added in slot 10 alongside the HA interconnect I/O module in slot 11.

## Internal system components

The storage processor (SP) is a subassembly within the chassis that contains the memory risers with the DIMMs and a fan tray with fan modules. The SP module also contains the 4 CPUs, which cannot be removed or replaced.

- The memory risers tray, which contains 8 memory risers with DIMMs, can be accessed from the front of the SP module. The memory risers are not hot swappable
- The fan tray, which contains 8 fan modules, can be accessed from the front of the SP module. The fans are hot swappable.

The DIMMS can be accessed by pulling the entire SP module away from the chassis. Depending on the model, there are DIMMs totaling 256 GB or 768 GB.

The figures show the location of the SP module, the DIMM risers accessed from a partly removed SP module, and the fan tray partly removed.

Do not lift the DD9800 system, or the storage processor (SP) module, or any modules by the handle. The handle is not designed to support the weight of the populated shelf. Also do not carry the DD9800 system or the SP by the handle. The handles are only intended to be used to insert or remove the SP module.



Figure 153. SP module



Figure 154. Releasing a memory riser

1. Left riser card ejector handle
2. Release button
3. Right riser card ejector handle





**Figure 155. Open fan tray**

**NOTE:** Do not loosen the blue thumbscrew on the SP latch handle to access the fan tray. Use the orange thumbscrews on the front as shown in the picture.

1. Left fan tray thumbscrew
2. Front panel left handle
3. Front panel right handle
4. Right fan tray thumbscrew
5. Location map of the fans

## DIMM modules

The DD9800 system contains the following memory configurations:

**Table 172. DD9800 memory configurations**

System	Base	Expanded	ER/DD Cloud Tier
DD9800	32 x 8 GB DIMMs (256 GB)	32 x 8 GB DIMMs + 32 x 16 GB DIMMs (768 GB)	32 x 8 GB DIMMs + 32 x 16 GB DIMMs (768 GB)

## Cooling fans

A system contains eight hot-swappable cooling fans in a 7+1 redundant configuration, which is located in the front of the system within a movable fan tray. The fans provide cooling for the processors, DIMMs, and I/O modules. Each fan has an LED which glows amber when the fan is failed or faulted. A system can run with one fan faulted.

## DD9800 and ES30 shelf guidelines

The system rediscovers newly configured shelves after it restarts. You can power off the system and recable shelves to any other position in a set, or to another set. To take advantage of this flexibility, you need to follow these rules before making any cabling changes:

- Do not exceed the maximum shelf configuration values for your system as listed in the following table below.
- Use the Installation and Setup Guide for your system to minimize the chance of a cabling mistake.
- A system cannot exceed its maximum raw external shelf capacity, regardless of added shelf capacity.

- ES30 SATA shelves must be on their own chain.

**Table 173. DD9800 and ES30 shelf configuration**

DD system	Memory required (GB)	SAS cards/port per card	ES30 support (TB)	Max shelves per set	Max number of sets	Max external capacity available (TB) <sup>1</sup>	Max RAW external capacity (TB) <sup>2</sup>
DD9800 <sup>3</sup>	256	3x4	SAS 30, 45, 60; SATA 15, 30, 45	5	6	504	630
DD9800 w/ HA <sup>3</sup>	256	3x4	SAS 30, 45, 60	5	6	504	630
DD9800 <sup>3, 4</sup>	768	3x4	SAS 30, 45, 60; SATA 15, 30, 45	5	6	1008	1260
DD9800 w/ HA <sup>3</sup>	768	3x4	SAS 30, 45, 60	5	6	1008	1260
DD9800 w/ ER <sup>3</sup>	768	4x4	SAS 30, 45, 60; SATA 15, 30, 45	7	8	2016	2520
DD9800 w/ Cloud Tier <sup>3</sup>	768	4x4	SAS 30, 45, 60; SATA 15, 30, 45	7	8	1008 (max), additional 240 SAS dedicated to Cloud Tier	1260 (max), additional 300 SAS dedicated to Cloud Tier
DD9800 w/ HA and Cloud Tier <sup>3</sup>	768	4x4	SAS 30, 45, 60	7	8	1008 (max), additional 240 SAS dedicated to Cloud Tier	1260 (max), additional 300 SAS dedicated to Cloud Tier

1. This figure only counts drives that have user data in the shelves.

2. The raw capacity of an ES30 is 125% of the available capacity.

3. Only available with DD OS 6.x and greater.

4. DDOS 6..x and greater and FS15 SSD shelf configuration

## Types of cabinets and power connections

The ES30 chassis is installed in two types of racks: 40U-C (existing racks) and the 40U-P (newer racks). The racks use one phase or 3-phase power connections.

### 3-Phase power connections for 40U-P (current racks)

Some environments use 3-phase power for 40U-P racks that are used for several systems. In those situations, it is desirable to balance the current draw across all three phases. The recommended 3-phase power cabling attempts to do that, but an optimal configuration depends on the specific installation.

## Cabling shelves

### NOTE:

- Before cabling the shelves, physically install all shelves in the racks. Refer to the rail kit installation instructions included with the ES30 shelf for rack mounting.

- The documentation refers to two SAS HBAs. If only one HBA is allowed in a system, then use another port as defined later for that specific system.
- On an HA system, add cables from the second node to open ports at the end of the sets. The ports on the second node must connect to the same sets as the corresponding ports on the first node.

Ports on the system's SAS HBA cards connect directly to a shelf controller's host port. For redundancy, you need to create dual paths by using a port on one SAS HBA card to connect to one shelf controller in each shelf set, and a port on another SAS HBA card to connect to another shelf controller in the same shelf set. With dual paths, if one SAS HBA card fails, the shelf is still operational. However, in the unlikely event any single shelf becomes completely disconnected from power or SAS cables and becomes disconnected from a previously operational shelf, the file system goes down and the shelf is not operational. This is considered a double failure.

There are two kinds of configurations: one shelf in a set or multiple shelves in a set.

## DD9500 and cabling

**NOTE:** If a system installation does not follow ALL of these rules, it is not a legitimate configuration.

Prerequisites:

- Follow the minimum and maximum shelf capacity configuration provided in the table.
- You cannot have ES30 SATA and ES30 SAS shelves in the same set.
- You cannot exceed the maximum amount of raw capacity displayed in the product's cabling table.
- You cannot exceed the maximum number of shelves displayed in the product's cabling table.
- You cannot have more than five ES30s in a single set (maximum of four is preferred).
- You can have seven ES30s for systems with Extended Retention software.
- There are no specific placement or cabling requirements for SSD shelves, or the metadata shelves for Cloud Tier configurations. These shelves can be installed and cabled the same way as standard ES30 shelves.

**Table 174. Minimum and maximum configurations**

System	DD9500	DD9500 w/	
Appliance	864 TB usable	864 TB usable	1008 TB usable
Minimum appliance shelf count	4	4	4
Maximum appliance shelf count	30	30	30
Extended Retention systems (ER)	1728 TB usable	2016 TB usable	2016 TB usable
Maximum shelves for ER	56	56	56
High Availability systems (HA)	864 TB usable	1008 TB usable	1008 TB usable
Maximum shelves for HA	42	42	47
Cloud Tier systems	1104 TB usable	1248 TB usable	1248 TB usable
Maximum shelves for Cloud Tier	42	42	47

The DD9500 base (non-Extended Retention) and HA systems supports six chains.

The following figures show cabling for base systems, HA systems, and systems with the Extended Retention software option.

**NOTE:** The racks are filled from bottom up.

## DD9800 and DS60 shelf guidelines

The system rediscovers newly configured shelves after it restarts. You can power off the system and recable shelves to any other position in a set, or to another set. To take advantage of this flexibility, you need to follow these rules before making any cabling changes:

- Do not exceed the maximum shelf configuration values for your system as listed in the following table.
- For redundancy, the two connections from a system to a set of shelves must use ports on different SAS I/O modules.
- Use the Installation and Setup Guide for your system to minimize the chance of a cabling mistake.
- A system cannot exceed its maximum raw external shelf capacity, regardless of added shelf capacity.
- ES30 SATA shelves must be on their own chain.
- If ES30 SAS shelves are on the same chain as a DS60, the maximum number of shelves on that chain is 5.

**Table 175. DD9800 and DS60 shelf configuration**

DD system	Memory required (GB)	SAS cards/port per card	DS60 support (TB)	Max shelves per set	Max number of sets	Max external capacity available (TB) <sup>1</sup>	Max RAW external capacity (TB)
DD9800 <sup>2, 3</sup>	256	3x4	SAS 45, 60	4	6	504	630
DD9800 w/ HA <sup>2, 3</sup>	256	3x4	SAS 45, 60	4	6	504	630
DD9800 <sup>2, 3</sup>	768	3x4	SAS 45, 60	4	6	1008	1260
DD9800 w/HA <sup>2, 3</sup>	768	3x4	SAS 45, 60	4	6	1008	1260
DD9800 ER <sup>2, 3</sup>	768	4x4	SAS 45, 60	4	8	2016	2520
DD9800 Cloud Tier <sup>2, 3</sup>	768	4x4	SAS 45, 60	5	8	1008 + 240 for Cloud Tier	1260 + 300 for Cloud Tier
DD9800 Cloud Tier w/ HA <sup>2, 3, 4</sup>	768	4x4	SAS 45, 60	5	8	1008 + 240 for Cloud Tier	1260 + 300 for Cloud Tier

**NOTE:** An entry of 45 corresponds to DS60-3 models and an entry of 60 corresponds to DS60-4 models.

1. This column only counts drives that have user data in the shelves. For example, a DS60 4-240 has 192TB.

2. With DD OS 6.x and greater with SSD.

3. Only available with DD OS 6.x and greater.

4. With Cloud Tier Storage.

## 3-phase power connections for 40U-P (current racks)

Some environments use 3-phase power for 40U-P racks used for several systems. In those situations it is desirable to balance the current draw across all 3 phases. The recommended 3-phase power cabling attempts to do that, but an optimal configuration is dependent on the specific installation.

## DD9500 and DD9800 cabling

**NOTE:** If a system installation does not follow ALL of these rules, it is not a legitimate configuration.

Prerequisites:

- Follow the minimum and maximum shelf capacity configuration provided in the table.
- You cannot have ES30 SATA and ES30 SAS shelves in the same set.
- You cannot exceed the maximum amount of raw capacity displayed in the product's cabling table.
- You cannot exceed the maximum number of shelves displayed in the product's cabling table.
- You cannot have more than five ES30s in a single set (maximum of four is preferred).
- You can have seven ES30s for systems with Extended Retention software.


- There are no specific placement or cabling requirements for SSD shelves, or the metadata shelves for Cloud Tier configurations. These shelves can be installed and cabled the same way as standard ES30 shelves.

**Table 176. Minimum and maximum configurations**

System	DD9500	DD9500 w/	
Appliance	864 TB usable	864 TB usable	1008 TB usable
Minimum appliance shelf count	4	4	4
Maximum appliance shelf count	30	30	30
Extended Retention systems (ER)	1728 TB usable	2016 TB usable	2016 TB usable
Maximum shelves for ER	56	56	56
High Availability systems (HA)	864 TB usable	1008 TB usable	1008 TB usable
Maximum shelves for HA	42	42	47
Cloud Tier systems	1104 TB usable	1248 TB usable	1248 TB usable
Maximum shelves for Cloud Tier	42	42	47

The DD9500 base (non-Extended Retention) and HA systems supports six chains.

The following figures show cabling for base systems, HA systems, and systems with the Extended Retention software option.

 **NOTE:** The racks are filled from bottom up.

## DD9900

This chapter contains the following topics:

**Topics:**

- [DD9900 system features](#)
- [DD9900 system specifications](#)
- [DD9900 storage capacity and configurations](#)
- [DD9900 front panel](#)
- [DD9900 SSD usage and configurations](#)
- [DD9900 rear panel](#)
- [PCIe HBAs](#)
- [DD9900 DIMM configurations](#)
- [DD6900, DD9400, and DD9900 storage shelves configurations and capacities](#)

## DD9900 system features

**Table 177. DD9900 system features**

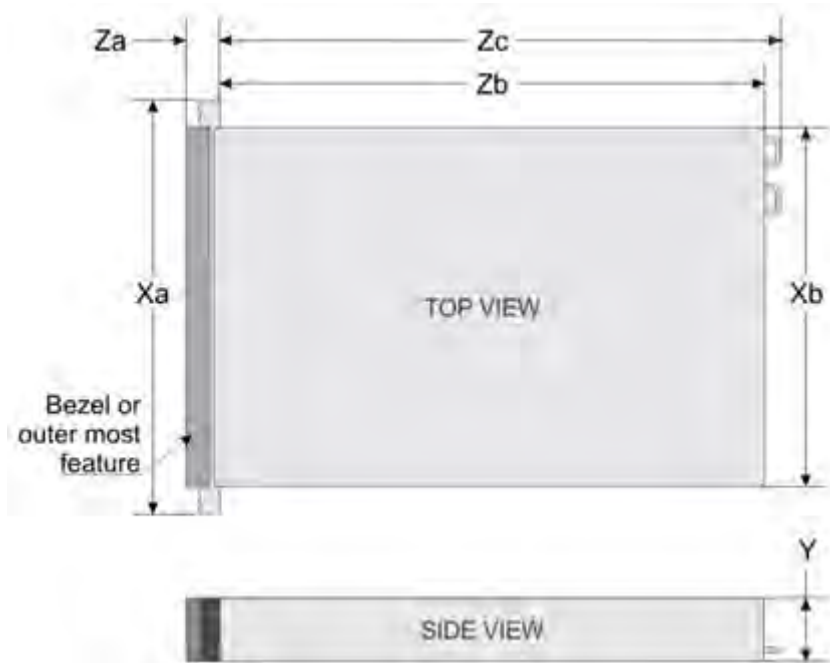
Configurations		Single Node	HA A-P
Processor		4 x Intel Xeon Gold, 2294 Mhz, 18C	
Kernel		4.4	
Memory Configurations	Total	1152 GB	
	DIMMs	24 x 16 GB + 24 x 32 GB	
HDD Drive Size		8TB (shipped, 3TB and 4TB also supported)	
Supported Capacity	Active Tier	576 <-> 1248 TBu	
	Cloud Tier	2016 TBu (Cloud Tier)	
Disk Groups	Active Tier	6 <-> 16	
	Over Provisioning	2	
	Cloud Tier (4 TB)	5	
SSDs for OS in 2.5" bays in head		4, 1.92TB, 1 WPD	
Stream Count		1885 Wr, 300 Rd	
Cache SSDs	2.5%	10 (External) 3.84 TB	
Cache SSD shelf	FS25	1	
HA Private Interconnect		N/A	(3) 10G Base-T ports (NDC)
16 GB NVRAM		1	
HW Accelerator	100 Quick Assist Technology (QAT) 8970	2	
Internal SAS	PowerEdge Raid Controller (PERC) H330+ 12 Gbps SAS	1	



**Table 177. DD9900 system features (continued)**

Configurations		Single Node	HA A-P
External SAS	PMC Quad Port 12 Gbps SAS	2 default, 3 supported	
SAS String Depth (max)	ES30/ES40	7	
	DS60	3	
Host interface HBAs	2-port 100 GbE-QSFP28	4 maximum	
	2-port QL41000 25 GbE-SFP28	4 maximum	
	4-port QL41164 10 GbE-SFP+	4 maximum	
	4-port QL41164 10GBASE-T	4 maximum	
	4-port QLE2694 16 Gb FC	4 maximum	
Network Daughter Card options (one of these 2)	4-port QL41000 10 GbE-SP+ FasLinQ	1	
	4-port QL41164 10GBASE-T	1	

## DD9900 system specifications



**Figure 156. System dimensions**

**Table 178. DD9900 system specifications**

Xa	Xb	Y	Za (with bezel)	Za (without bezel)	Zb	Zc
482.0 mm (18.98 inches)	434.0 mm (17.09 inches)	130.3 mm (5.13 inches)	35.0 mm (1.37 inches)	22.0 mm (0.87 inches)	726.2 mm (28.59 inches)	777.046 mm (30.59 inches)

A DD9900 system weighs up to 110.01 lbs (49.9 kg).

**Table 179. System operating environment**

Operating Temperature	50° to 95° F (10° to 35° C), derate 1.1° C per 1000 feet, above 7500 feet up to 10,000 feet (32.25° C at 10,000)
Operating Humidity	20% to 80%, non-condensing
Non-operating Temperature	-40° to +149° F (-40° to +65° C)
Operating Acoustic Noise	L <sub>wad</sub> sound power, 7.5 Bels

## DD9900 storage capacity and configurations

The following table provides storage capacity and configuration information for the DD9900 system.

**Table 180. DD9900 storage capacity and configurations**

Tier	CPU-SP SKU	Memory	Front 2.5" SSDs	Max. Useable Capacity	Cloud Tier Metadata
DD9900 Base	18 core, 150 W 6240	1152 GB (24 x 16 GB) + (24 x 32 GB)	10	1248TBu	N/A
DD9900 with DD Cloud Tier <sup>1</sup>	18 core, 150 W 6240	1152 GB (24 x 16 GB) + (24 x 32 GB)	10	2016TBu	300 TB raw/240 TB usable

<sup>1</sup> DD Cloud Tier can be added to a DD9900 and is enabled by a license and disk packs for the DD Cloud Tier metadata.

The Memory column lists the total memory that is required and the number and type of the DIMMs used. All memory DIMMs are DDR4 RDIMMs at the highest supported speed of 2666MT/s.

## High Availability

DD9900 supports Active-Passive High Availability (A-P HA or just A-P). The following table summarizes the hardware changes to support A-P HA:

**Table 181. HA configuration requirements**

Hardware Change to support HA	Active-Passive HA
Additional memory	No extra memory required.
HA private interconnect	Cluster Interconnect : A-P requires the use of two ports from the on-board quad-port 10 GbE Network Daughter Card.
NVRAM	A-P requires a single 16 GB NVRAM card (same as non-HA).
SAS Connectivity	Both nodes of an A-P HA pair require redundant SAS connectivity to the storage array. (Note: a single node system also has redundant connectivity to the storage arrays.)
SSD Requirements	SSDs are contained within FS25 and must be accessible from both nodes.

## HA Network Interconnect

The HA Network Interconnect, required for HA configurations, is a dedicated 10 GbE connection between the two nodes of an HA pair. The interconnect is used to write data (and metadata) from the active node's NVRAM to the passive node's NVRAM.

Two 10GbE links are used to meet the bandwidth requirements for the private interconnect. Traffic across the private interconnect has roughly the same bandwidth as is written to the NVRAM card. The dual 10-GbE links can move about 2 GB/s in each direction.

## HA SAS Interconnect

HA configurations require that the SSDs' cache drives be shared between both nodes and have redundant SAS connections to all shelves.

## DD9900 front panel



Figure 157. DD9900 front panel

Table 182. Front panel features

Item	Ports, panels, and slots	Description
1	Left control panel	Contains system health and system ID, status LED, and optional iDRAC Quick Sync 2 (wireless).
2	Drive slots	Enable you to install drives that are supported on your system.
3	Right control panel	Contains the power button, VGA port, iDRAC Direct port, and USB ports.
4	Information tag	The Information tag is a slide-out label panel that contains system information such as Service Tag, NIC, MAC address, and so on. If you have opted for the secure default access to iDRAC, the Information tag also contains the iDRAC secure default password.
5	Drive bay	Hard drive bay

Table 183. Front LEDs

Name	Color	Purpose
Control Panel Status LED	Blue/Amber	Status: <ul style="list-style-type: none"><li>● Healthy: Solid Blue</li><li>● Fault: Blink Amber</li><li>● Sys ID: Blink Blue</li></ul>
System Power Button/LED	Green	Indication that the system has power.
Drive activity LEDs	Green	Lit green when the drive is powered. Blinks during drive activity.
Drive service LEDs	Green	Lit solid amber when a disk drive needs service.

## Front LEDs

Figure 158. Front left control panel status LEDs



**NOTE:** The indicators display solid amber if any error occurs.

**Table 184. System health and system ID indicator codes**

System health and ID indicator code	
Solid blue	Indicates that the system is turned on, system is healthy, and system ID mode is not active. Press the system health and system ID button to switch to system ID mode.
Blinking blue	Indicates that the system ID mode is active. Press the system health and system ID button to switch to system health mode.
Solid amber	Indicates that the system is in fail-safe mode.
Blinking amber	Indicates that the system is experiencing a fault. Check the System event log or the LCD panel, if available on the bezel, for specific error messages.



**Figure 159. Front right control panel power button LEDs**

**Table 185. Right control panel features**

Item	Indicator, button, or connector	Description
1	Power button	Indicates if the system is turned on or off. Press the power button to manually turn on or off the system. <b>NOTE:</b> Press the power button to gracefully shut down an ACPI-compliant operating system.

**Table 185. Right control panel features (continued)**

Item	Indicator, button, or connector	Description
2	USB port (2)	The USB ports are 4-pin, 2.0-compliant. These ports enable you to connect USB devices to the system.
3	iDRAC Direct port	The iDRAC Direct port is micro USB 2.0-compliant. This port enables you to access the iDRAC Direct features.
4	iDRAC Direct LED	The iDRAC Direct LED indicator lights up to indicate that the iDRAC Direct port is connected.
5	VGA port	Enables you to connect a display device to the system.

**Table 186. iDRAC Direct LED indicator codes**

iDRAC Direct LED indicator code	Condition
Solid green for two seconds	Indicates that the laptop or tablet is connected.
Flashing green (on for two seconds and off for two seconds)	Indicates that the laptop or tablet that is connected is recognized.
Turns off	Indicates that the laptop or tablet is unplugged.



**Figure 160. Drive LEDs**

The front contains 25 2.5" disk drive slots that can be populated with SSDs. Each SSD is housed in a drive carrier that contains two LEDs at the bottom of the carrier. The carrier's left blue LED is lit whenever an SSD is present in the slot, and it blinks when I/O activity is occurring on the disk. The right amber LED is usually off and lights amber to indicate that the disk is faulted and must be serviced.

## DD9900 SSD usage and configurations

DD9900 system uses an 8 x 2.5" drive slot mid-plane. However, metadata cache devices are implemented using the external flash shelf FS25. This allows dual access to all SSD devices which doubles the SSD access bandwidth.

### SSD configurations

The SSD slots on the front of the enclosure are shown below. The system come from the factory with SSDs populated in the enclosure.

DD9900 supports 2.5% SSD option out of factory. Based on 3.84 TB SSD capacity, the required number of SSDs for each DD9900 configuration is provided in the following table.

**Table 187. DD9900 SSD configurations**

Configuration	Single node	HA
3.84 TB SSDs in 2.5" bays	10 (External) 3.84 TB	

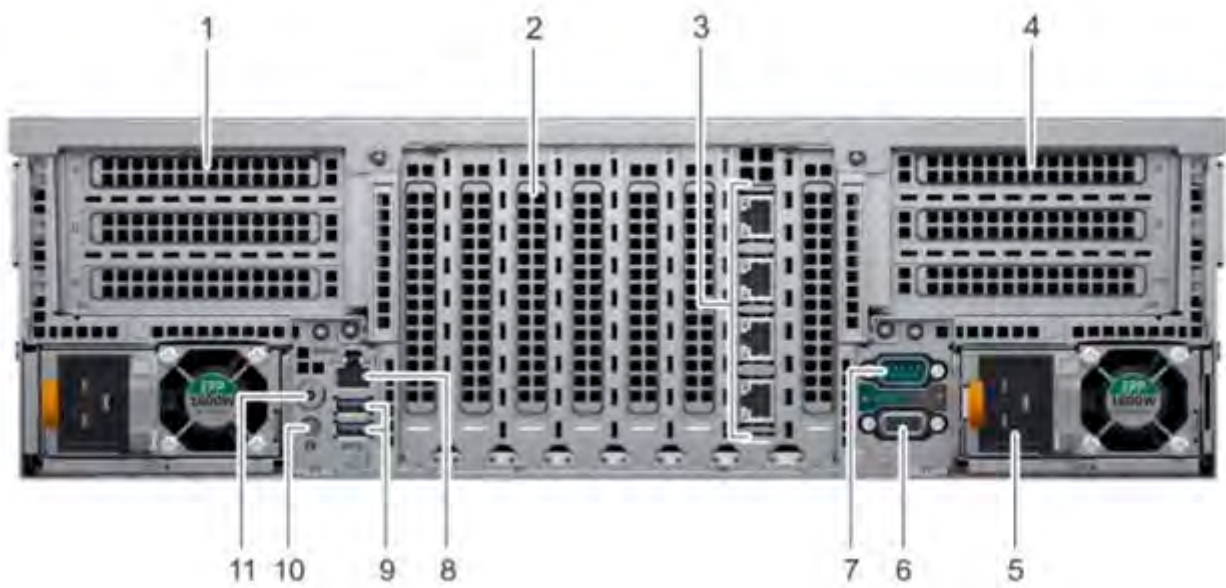
## SSD boot drives

Additional SAS SSDs are used to boot the DD OS operating system. Boot disks and/or external disk shelves are used to log system information. Boot disks are installed from the other end of the front 2.5" disk slots to physically differentiate the cache SSDs.

**Table 188. SSD boot drives**

# of boot disks	Installed in slots
4	0,1,2,3

## DD9900 rear panel



**Figure 161. DD9900 rear panel**

Item	Slot, button, or connector	Description
1	Half-height PCIe expansion card slot	The PCIe expansion card slot connects one half-height PCIe expansion cards to the system.
2	Full-height PCIe expansion slots	The PCIe expansion card slot connects up to three full-height PCIe expansion cards to the system.
3	NIC ports (4)	The NIC ports that are integrated on the network daughter card (NDC) provide network connectivity.
4	Half-height PCIe expansion card slot	The PCIe expansion card slot connects one half-height PCIe expansion cards to the system.
5	Power supply unit (2)	Supports two AC power supply units (PSUs)

Item	Slot, button, or connector	Description
6	VGA port	Enables you to connect a display device to the system.
7	Serial port	Enables you to connect a serial device to the system.
8	iDRAC9 Enterprise port	Enables you to remotely access iDRAC.
9	USB port (2)	The USB ports are 9-pin and 3.0-compliant. These ports enable you to connect USB devices to the system.
10	System identification button	The System Identification (ID) button is available on the front and back of the systems. Press the button to identify a system in a rack by turning on the system ID button. You can also use the system ID button to reset iDRAC and to access BIOS using the step through mode.
11	Status indicator cable port	Enables you to connect the status indicator cable and view system status when the CMA is installed.

## Rear LEDs



**Figure 162. Onboard ID and iDRAC LEDs**

- iDRAC management port:
  - The green link LED on the left is lit whenever there is link at 1000BaseT and 100BaseT speeds. The link LED is off when the link speed is 10BaseT or there is no link.
  - The green link LED on the right blinks whenever there is traffic on the port.
- System identification LED: This blue LED can be turned on by software to visually identify the system.

## PSU FRU LEDs

There are two power supplies, one in the upper left of the rear chassis and one on the bottom right. Each power supply has three LEDs: AC good, DC good, and Service. The top PSU is "right-side up" and the bottom PSU is "upside down."

**Table 189. PSU FRU LEDs**

Name	Color	Definition
AC Good	Green	AC input is as expected.
DC Good	Green	DC output is as expected.
Service	Amber	PSU has a fault condition and a must be replaced.



# PCIe HBAs

A slot in the chassis that does not contain an HBA must have a filler panel installed in the empty slots. This is required for EMI compliance.

This system supports 13 I/O modules slots, three of which are 8-lane PCIe Gen3, and ten are 16-lane PCIe Gen3. Several networking, NVRAM, SAS, and Fibre Channel I/O modules are supported.

## Slot assignment

The following table lists the DD9900 configuration slot assignments:

**Table 190. DD9900 slot assignments**

Description	Slot
QLogic, 41164 4 Port, 10GbE SFP+ PCIe, Full Height	6, 8, 4, 10, 3, 13, 5
QLogic, 41164 4 Port, 10GBASE-T PCIe, Full Height	8, 4, 3
QLogic, 41262 2 Port, 25Gb SFP28 PCIe, Full Height	6, 8, 4, 10, 3, 13, 5
Mellanox CX-5 2x 100GbE QSFP28 PCIe, FH	8, 3, 4, 13, 10
PERC H330+ SAS RAID Adapter, FH	1
QAT,INTEL,8970,FH, Avnet p/n 1QA89701G1P5	2, 7
PM8072,SAS12,4P,FH, MicroSemi 2295200-R	9, 12, 5
FC16,QLE2694-DEL-BK,TRG,QP,FH	5, 6, 8, 4, 10, 3, 13
16GB NVRAM,FH	11

Host Interface (x16) is 2-port 100 Gb QSFP+ Ethernet.

Host Interface (x8) are:

- 4-port 25 Gb SFP28 Ethernet
- 4-port 10 Gb SFP+ Ethernet
- 4-port 10GBaseT Ethernet
- 4-port 16 Gb Fibre Channel

**i** **NOTE:** Any of the Host Interface (x8) may be inserted into the slots 0, 1, 2, & 5, but the Host Interface (x16) may only reside in slots 0 & 2 (the x16 slots).

SAS is 4-port 12 Gb SAS and is required for HA configurations.

NVRAM is the 16GB NVRAM.

SAS Mezzanine is 2-port 12 Gb Mini-SAS HD SAS controller mezzanine.

Host Interface Mezzanine is either:

- 4-port 10GBaseSR SFP+ Ethernet mezzanine
- 4-port 10GBaseT RJ45 Ethernet mezzanine

## I/O population rules

The following figures show the I/O module slot numbers.

The slot labeled N is the network daughter card, which contains ports ethMa, ethMb, ethMc, and ethMd.

The physical interface name format for the other I/O module slots is ethXy, where X is the slot number and y is an alphanumeric character. For example, eth0a.

For most horizontal I/O module NIC interfaces, the port numbering goes from left to right, with ethXa on the left. The horizontal I/O module slots on the left-in slots 11-13 are inverted. The port numbering on these I/O modules in these slots goes from right to left, with ethXa on the right.

For vertical I/O module NIC interfaces, the port numbering goes from top to bottom, with ethXa at the top.

The management port ethMa is the first port set up by the Configuration Wizard. It is marked with a red rectangle in the figure below.



**Figure 163. Slot numbering**

The general population rules can be summarized as:

1. Populate a given I/O in the available slots listed.
2. Select the first available slot in the group.
3. Follow the steps for each I/O in the order specified.
4. Slots 0 and 2 should be reserved for x16 unless there are no available x8 slots.

**NOTE:** Installing HBAs requires opening the system and installing the HBA into the riser.

Riser#	Slots (from top to bottom)
Left	11, 12, 13
Right	8, 9, 10

Slots 1, N, 2, 3, 4, 5, 6, and 7 are not installed on a riser.

## Gen3 PCIe

Slots support Gen3 PCIe.

## I/O module servicing

All I/O modules are user serviceable and may be replaced when the system is powered off. On-line service of I/O modules is not support. A module that is hot-inserted into the system will remain powered off and will not be powered on until the next reboot of the system. A module that is hot-removed causes an operating system to immediately reboot.

# DD9900 DIMM configurations

The SP Module contains 4 Intel SP processors each with an integrated memory controller that supports six channels of DDR4 memory. The CPU allows two DIMM slots per channel, so the SP Module supports 24 DIMM slots.

Each DDR4 DIMM is connected to the system board through an industry standard 288-pin DDR4 DIMM connector. This system uses registered DIMMs with Dell EMC ControlCenter at 72 bits wide (64-bits data + 8-bits Dell EMC ControlCenter) up to a maximum of 2666MT/s speed.

**Table 191. Memory configurations**

Tier	Total Memory	Memory DIMM Configuration
DD9900 Base	1152 GB	24 x 32GB + 24 x 16GB
DD9900 Cloud Tier	1152 GB	24 x 32GB + 24 x 16GB

## Memory locations

To ensure maximum memory performance, there are memory DIMM population rules so that the memory loading and interleaving are optimal. The following table below specifies the DIMM location rules. Each DIMM location contains either a 16GB DIMM or a 32GB DIMM.

**Table 192. DD9900 base DIMM configuration CPU 1**

Total (GB)	Channel C		Channel B		Channel A		Channel D		Channel E		Channel F	
	J0	J1	J2	J3	J4	J5	J6	J7	J8	J9	J10	J11
1152	32GB	16GB	32GB	16GB	32GB	16GB	16GB	32GB	16GB	32GB	16GB	32GB

**Table 193. DD9900 base DIMM configuration CPU 2**

Total (GB)	Channel C		Channel B		Channel A		Channel D		Channel E		Channel F	
	J12	J13	J14	J15	J16	J17	J18	J19	J20	J21	J22	J23
1152	32GB	16GB	32GB	16GB	32GB	16GB	16GB	32GB	16GB	32GB	16GB	32GB

## DD6900, DD9400, and DD9900 storage shelves configurations and capacities

DD6900, DD9400, and DD9900 do not store data on internal disk drives and rely on external disk array shelves to provide storage. DS60 disk shelves and ES40 shelves are connected to systems using 12 Gb Mini-SAS HD ports, which are implemented on the SAS HBAs.

The systems also support external metadata storage (cache) shelf FS25. External cache shelf only hosts DD OS depended metadata for performance acceleration.

The ES40 SAS shelf contains 15 drives, which includes 12 drives of usable storage, two parity drives, and one hot spare.

The DS60 shelf contains 60 drives. Drives are configured in four groups of 15 drives. Each group contains two parity drives and one hot spare, so each group provides 12 drives of usable storage. A fully configured DS60 shelf provides 48 drives of usable storage.

**Table 194. Shelves shipped from factory, in rack**

DD6900	DD9400	DD9900
4 TB ES40	8 TB DS60	8 TB DS60

**Table 195. Shelves shipped from factory, boxed**

DD6900	DD9400	DD9900
4 TB ES40	8 TB ES40	8 TB ES40
4 TB DS60	8 TB DS60	8 TB DS60

**Table 196. Additional shelves supported**

DD6900	DD9400	DD9900
4 TB SAS ES30/DS60	4 TB SAS ES30/DS60	4 TB SAS ES30/DS60
3 TB SAS ES30/DS60	3 TB SAS ES30/DS60	3 TB SAS ES30/DS60

**NOTE:** 3 TB shelves are only support on controller upgrades and not on fresh installs.

**Table 197. Shelf usable capacities**

Hard drive size (TB)	Shelf	Useable TB
4	ES40	48
4	DS60	192
8	DS60	384

The following table lists the maximum number of shelves per chain:

**Table 198. Supported shelf count per chain**

Shelf type	Max # from factory	Max # per chain
SAS ES30/ES40	4	7
DS60	2	3
DS60 + ES30/ES40	n/a	5
F25	1	1

The connector type for ES30 is Mini-SAS. Special cables may be necessary when combining ES30 and ES40 shelves on the same chain (enabled but not recommended).

DD9400 and DD9900 system capacities are optimized for use with DS60 shelves containing 8 TB drives. DS60 shelves can be populated with one to four packs of fifteen 8 TB, or 4 TB drives. Different 4 TB and 8 TB capacity disk packs may be mixed within a single DS60 shelf. ES40 SAS shelves and DS60 shelves of mixed capacities may be attached so long as the maximum storage capacity of the system is not exceeded.

This chapter contains the following topics:

**Topics:**

- [DS60 overview](#)
- [DS60 site requirements](#)
- [DS60 hardware specifications](#)
- [DS60 front panel](#)
- [Back panel](#)
- [Disk enclosure interior](#)
- [Expansion shelf cables](#)
- [Ports](#)

## DS60 overview

Adding DS60 expansion shelves to a system increases the system's storage capacity.

The expansion shelves are organized by sets (or chains). The following table shows the number of DS60 shelves in set (chain) each system can support.

**Table 199. DS60 shelf set support**

System (base)	DS60 shelves
DD6300	1 shelf only*
DD6800, DD9300, DD9500, and DD9800	4 per set (chain)

\* DD6300 systems only supports the addition of one DS60 expansion shelf.

## DS60 site requirements

This table lists the DS60 site requirements. See [DS60 hardware specifications](#) on page 265 for hardware specifications information.

**Table 200. Site requirements**

Requirement	DS60 Expansion Shelf
Vertical space in standard 19", 4-post rack	5U including a 1U Cable Managements Tray. Do not use a two-post rack. See the slide rail and installation documentation in the packaging for installing in a rack.
Air conditioning	Air conditioning that can cope with the maximum BTU/hr thermal rating.
Temperature controls	Adequate temperature control with a gradient (change) not to exceed 30° C in an hour.
Front bezel clearance	1.56 inches (4.0 cm) of unobstructed clearance.
Back panel clearance	5 inches (12.7 cm) of unobstructed clearance.
Airflow	In a closed or multi-unit rack, ensure that the unit has adequate airflow. If the equipment is mounted in an enclosed (as opposed to a four-post open rack), the front and rear

**Table 200. Site requirements (continued)**

Requirement	DS60 Expansion Shelf
	doors should have 65% minimum open area for airflow. Whether in an open or enclosed rack, use filler panels to prevent hot air re-circulation. The rack design and installation should take into consideration the maximum ambient operating temperature of the equipment, which is 35° C.
Power/grounding	The Power distribution within the rack should provide a safe electrical earth connection. Voltage should be 200-240 VAC; 50 or 60 Hz. Plug four power cords - two from each power supply into separate branch circuit supplies for redundancy—one set of cords from one power supply goes to one branch and the second set of cords from the other power supply goes to a different branch. Each receptacle must be capable of safely supplying 0.94 amps from each power socket or 1.87 amps from each socket in case of a redundant circuit.

## DS60 hardware specifications

**NOTE:** All ratings assume a fully configured DS60 shelves.

**Table 201. Hardware specifications**

Specification	Description
AC line voltage	200 to 240 Vac ± 10%, single-phase, 47 to 63 Hz
AC line current (operating maximum)	4.9 A max at 200 Vac
Power consumption (operating maximum)	980 VA (931W) max
Power factor	0.95 min at full load, low voltage
Heat dissipation (operating maximum)	3.36 x 10 <sup>6</sup> J/hr, (3177 Btu/hr) max
Dimensions (rack mounted)	<ul style="list-style-type: none"> <li>Height: 8.75 in (22.23 cm) 5U (4U plus 1U cable management tray).</li> <li>Width including rails: 17.50 in (44.45 cm)</li> <li>Depth (chassis only): 34.5 in (87.63 cm)</li> <li>Maximum depth (fully configured): 36.4 in (92.46 cm)</li> </ul>
Shelf weight	<ul style="list-style-type: none"> <li>Without FRUs installed: 55.0 lb ( 24.7 kg)</li> <li>With FRUs installed: 225.0 lb (102 kg)</li> </ul>
Operating temperature	<ul style="list-style-type: none"> <li>Ambient temperature: 41° F to 104° F (5° C to 40° C)</li> <li>Temperature gradient: 18° F/hr (10° C/hr)</li> <li>Relative humidity extremes: 20% to 80% noncondensing</li> </ul>
Recommended operating relative humidity	40% to 55% noncondensing
Operating elevation	-50 to 7500 ft (-16 to 2300 m)
Non-operating (shipping and storage) temperature	<ul style="list-style-type: none"> <li>Ambient temperature: -40° F to 149° F (-40° C to 65° F)</li> <li>Temperature gradient: 45° F/hr (25° C/hr)</li> <li>Relative humidity: 10% to 90% noncondensing</li> <li>Elevation: -50 to 35,000 ft (-16 to 10,600 m)</li> </ul>

## DS60 front panel



Figure 164. DS60 front panel

**NOTE:** The front LEDs are identified inside the red rectangle.

If there is a problem with the enclosure, the enclosure fault light LED (marked with a triangle with an exclamation mark) is amber. When the shelf is powered on and active, the disk enclosure power LED (marked with a circle with a vertical line) is blue.

Table 202. LED status lights

Light	Quantity	Color	Meaning
Disk Enclosure Power	1	Blue	Power to enclosure is on.
Disk Enclosure Fault	1	Amber	On when any fault condition exists; if the fault is not obvious from a disk or fan module light, look at the back of the disk enclosure.

**NOTE:** The individual disk LEDs are only visible when the disk enclosure is opened to verify the disks inside.

For part replacement information, refer to the *DS60 Expansion Shelf Installation and FRU Replacement Guide*.

## Back panel

The back panel has two dual power supplies and two LCCs (Link Controller Cards).



Figure 165. DS60 back panel

Each controller has 4 SAS ports (laid out as 2 pairs). Standard systems and systems with the licensed HA feature only use ports 0 and 2 on each controller. Ports 1 and 3 typically have a plastic plug blocking the unused ports to make inserting a cable into the correct ports easier.



**Table 203. Status lights visible from rear of disk enclosure**

Light	Quantity	Color	Meaning
Controller power	1 per controller	Green	On when the Controller is powered on.
Controller fault	1 per controller	Amber	On when either the Controller or a SAS connection is faulty. On during power-on self test.
Link active	4 per controller	Blue	On when the host connection is active.
Power supply input voltage	1 per power supply	Green	Input power green when it is working.
Power supply fault*	1 per power supply	Amber	<ul style="list-style-type: none"> <li>On when the power supply is faulty or is not receiving AC line voltage.</li> <li>Flashing when either a multiple blower or ambient over temperature condition has shut off DC power to the system.</li> </ul>

The DS60 continues to run with a single power supply and two fans (out of the three fans).

## Disk enclosure interior

The disks are visible when the DS60 is pulled out of the rack and the top cover is removed from the chassis. There are also three fans in the front of the disk enclosure and each fan has a fault LED.

Each disk in the enclosure has two LEDs. The active LED glows blue when the disk is functional. The disk fault LED glows amber when the disk has failed.

**NOTE:** The individual disk and fan LEDs are only visible when the disk enclosure is opened to verify the disks inside.




**Figure 166. Fans and disk drives inside the disk enclosure**

**Table 204. LED status lights**

Light	Quantity	Color	Meaning
Disk Active <b>NOTE:</b> Only visible after the disk enclosure is opened.	1 per disk module	Blue	<ul style="list-style-type: none"> <li>No LED when the slot is empty or has a filler module. Also, off when the disk is powered</li> </ul>

**Table 204. LED status lights (continued)**

Light	Quantity	Color	Meaning
			<p>down by command; for example, the result of a temperature fault.</p> <ul style="list-style-type: none"> <li>• Fast blinking when the SAS drive is powered up but not spinning; this is a normal part of the spin-up sequence, occurring during the spin-up delays of a slot.</li> <li>• On when the drive has power but is not handling any I/O activity (the ready state).</li> <li>• Disk and fan lights are only available when enclosure is removed from the chassis.</li> <li>• Slow blinking when the drive is spinning and handling I/O activity.</li> </ul>
Disk Fault  <b>NOTE:</b> Only visible after the disk enclosure is opened.	1 per disk module	Amber	On when the disk module is faulty, or as an indication to replace the drive.
Fan fault	1 per fan module	Amber	On when the fan module is faulty, or as an indication to replace the fan.

The DD OS software manages the drives in packs (groups) of 15. A top down view of the chassis shows that the disks are arranged in four packs (groups) of 15 drives. The packs are color coded—pack 1 purple, pack 2 is yellow, pack 3 is green, and pack 4 is pink. A pack must have the same size drives. Pack 1 is shown within the red rectangle.



**Figure 167. Drives as packs**

The next table shows how the drives are distributed by packs (groups) and numbered physically. The bottom of the table represents the front of the shelf

**Table 205. Physical drives**

Rows	Pack 1	Pack 2	Pack 3	Pack 4
E	0-2	3-5	6-8	9-11
D	0-2	3-5	6-8	9-11
C	0-2	3-5	6-8	9-11
B	0-2	3-5	6-8	9-11
A	0-2	3-5	6-8	9-11

Although the disk numbers are physically 0 to 59, the disks are reported logically by system software commands in two ways:

- A range from 1 to 60, usually reported with the enclosure number (e.g. 3.37)
- The position matrix A-E (1-12)

For part replacement information, refer to the *DS60 Expansion Shelf Installation and FRU Replacement Guide*.

# Expansion shelf cables

Expansion shelves are connected to each other and to the controller with qualified cables. The expansion shelf can be connected to supported systems only by using SAS (serial-attached SCSI) cables. A shelf with qualified disks can be added as an expansion shelf if there are complete drive packs (15 in a pack) in the correct position.

**NOTE:** Shelves for other Dell EMC product lines look identical. Check the product numbers when unpacking.

## DS60 cables

The DS60 shelves use cables with HD-mini-SAS connectors at both ends to connect the shelves to the controllers that have SAS I/O modules.

The DS60 connector is referred as the HD-mini-SAS connector and is same as the I/O module connectors. These cables are available in 3M, 4M, and 5M lengths.

Use the appropriate length for the connection you are making:

- Use the 3-meter cable in the same rack either to connect to a controller or shelf to adjacent shelf.
- Use a 3-meter, 4-meter, or 5-meter cable when a DS60 is in another rack.



Figure 168. HD-mini-SAS connector

Table 206. HD-mini-SAS to mini-SAS cable part numbers

Cable Part Number	Cable Length
038-004-380-01	3M(118 in.)
038-000-212-00	4M (158 in.)
038-000-214-00	5M (196 in.)

Special cables must be used when attaching an ES30 to a chain with a DS60. Specifically, one HOST (circle) connection and one EXPANSION (diamond) cables are connected between the ES30 LCC and the DS60 LCC connection. Since this is not a common situation, only two expansion cable lengths are available.

Table 207. HD-mini-SAS to ES30 host and ES30 expansion port cable part numbers

Cable Part Number	Cable Type	Cable Length
038-003-810	Host	2M (78 in.)
038-003-813	Host	5M (196 in.)

**Table 207. HD-mini-SAS to ES30 host and ES30 expansion port cable part numbers (continued)**

<b>Cable Part Number</b>	<b>Cable Type</b>	<b>Cable Length</b>
038-004-108	Expansion	2M (78 in.)
038-004-111	Expansion	5M (196 in.)

The cable connectors must be secured with their latch assembly.

## Ports

Depending on the model, a system has two to four quad-port SAS IO modules installed. The DS60 shelf has two controllers, and each DS60 controller has four ports, labeled 0, 1, 2, and 3 (right to left).

This chapter contains the following topics:

**Topics:**

- [ES30 overview](#)
- [Site requirements](#)
- [ES30 hardware specifications](#)
- [Front panel](#)
- [Back panel](#)
- [Ports](#)

## ES30 overview

Adding ES30 expansion shelves to a system increases the system's storage capacity.

The expansion shelves are organized by sets (or chains). The following table shows the number of ES30 shelves than can be in a set.

**Table 208. ES30 shelves in a set**

Configuration	ES30 shelves
Base systems	1–4
Extended Retention software option	1–7

For redundancy, a shelf set is usually connected to two separate SAS I/O modules or HBA cards on the controller, and all of the shelves within a set are connected to each other via dual paths.

## Site requirements

This table lists the site requirements.

**Table 209. Site requirements**

Requirement	expansion shelf
Vertical Space in Standard 19", 4-post Rack	3U. Do not use a two-post rack. See the slide rail and installation documentation in the packaging for installing in a rack.
Air Conditioning	Air conditioning that can cope with the maximum BTU/hr thermal rating.
Temperature Controls	Adequate temperature control with a gradient (change) not to exceed 30° C in an hour.
Front Bezel Clearance	1.56 inches (4.0 cm) of unobstructed clearance.
Back Panel Clearance	5 inches (12.7 cm) of unobstructed clearance.
Airflow	In a closed or multi-unit rack, ensure that the unit has adequate airflow. If the equipment is mounted in an enclosed (as opposed to a four-post open rack), the front and rear doors should have 65% minimum open area for airflow. Whether in an open or enclosed rack, use filler panels to prevent hot air recirculation. The rack design and installation should take into consideration the maximum ambient operating temperature of the equipment, which is 35° C.
Power/ Grounding	Two single-phase AC power outlets with an earth ground conductor (safety ground). A safe electrical earth connection must be provided to each power cord. Voltage should be 100-120 VAC or 200-240 VAC; 50 or 60 Hz. Use only with branch circuits protected by a minimum

**Table 209. Site requirements (continued)**

Requirement	expansion shelf
	15A overcurrent protector. Plug the two power cords into separate branch circuit supplies for redundancy.

## ES30 hardware specifications

**NOTE:** All ratings assume a fully configured ES30.

**Table 210. ES30 hardware specifications**

Specification	Description
AC line voltage	100 to 240 Vac ± 10%, single-phase, 47 to 63 Hz
AC line current (operating maximum)	2.8 A max at 100 Vac, 1.4 A max at 200 Vac
Power consumption (operating maximum)	280 VA (235 W) max
Power factor	0.98 min at full load, low voltage
Heat dissipation (operating maximum)	8.46 x 10 <sup>5</sup> J/hr, (800 Btu/hr) max
Dimensions (rack mounted, with bezel)	<ul style="list-style-type: none"> <li>Width: 17.62" (45 cm) Depth: 14" (35.56cm)</li> <li>Height: 5.25" (13.34cm) 3 RU</li> </ul>
Maximum Weight	68 lbs (30.8 kg)

**Table 211. System operating environment**

Operating Temperature	<ul style="list-style-type: none"> <li>Ambient temperature: 10° C to 35° C (50° F to 95° F)</li> <li>Temperature gradient: 10° C/hr (180° F/hr)</li> <li>Relative humidity extremes: 20% to 80% noncondensing</li> </ul>	
Recommended Operating Relative Humidity	40% to 55% noncondensing	
Operating Humidity	<ul style="list-style-type: none"> <li>Ambient temperature: -40° C to 65° C (-40° F to 149° F)</li> <li>Temperature gradient: 25° C/hr (45° F/hr)</li> <li>Relative humidity: 10% to 90% noncondensing</li> </ul>	
Non-operating Temperature	-40° to +149° F (-40° to +65° C)	
Operating Acoustic Noise	<p>Sound power, LWAd: 7.4 bels. Sound pressure, LpAm: 58 dB. (Declared noise emission per ISO 9296.)</p> <p>Expansion Shelves: Max 58 dB LpA average measured at bystander positions</p>	

## Front panel

After you unlock and remove the snap-on bezel on the front panel, the 15 disks are visible. Disk numbers, as reported by system commands, range from 1 to 15. When facing the front panel, Disk 1 is located in the leftmost slot in the enclosure and Disk 15 in the rightmost slot.





Figure 169. ES30 front panel (bezel removed)

**NOTE:** The flanges or sheet metal on the ES30 show 0 to 14 but the software will refer to the logical numbering of 1 to 15.

Each disk in the enclosure has two LEDs. The disk's active LED glows green when the disk is functional. The disk fault LED glows amber when the disk has failed.

If there is a problem with the enclosure, the enclosure fault light is amber. The disk enclosure power light should be on (blue) when the shelf is powered on.

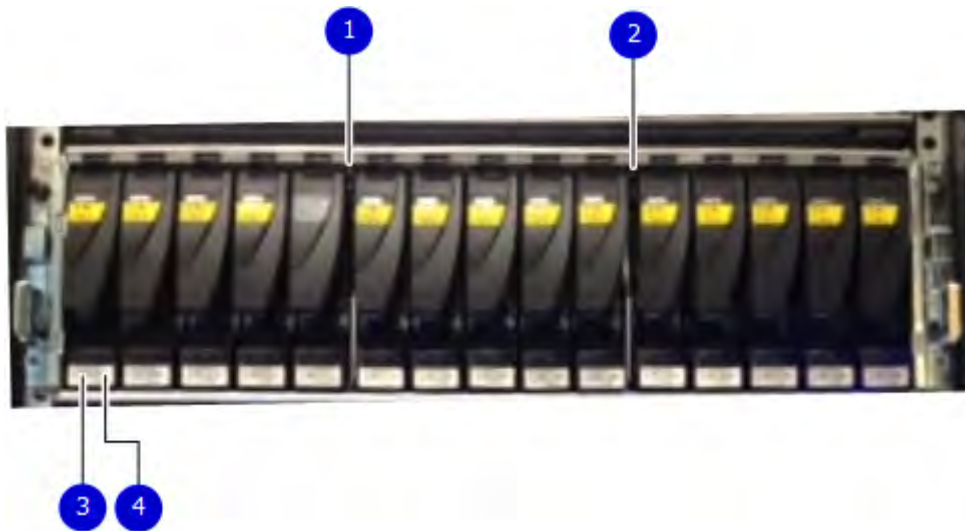


Figure 170. Front panel LEDs

1. Disk enclosure fault light
2. Disk enclosure power light
3. Disk active light
4. Disk fault light

Table 212. Status lights visible from front of disk enclosure

Light	Quantity	Color	Meaning
Disk enclosure fault light	1	Amber	On when any fault condition exists; if the fault is not obvious from a disk module light, look at the back of the disk enclosure.
Disk enclosure power light	1	Blue	Power to enclosure is on.
Disk active light	1 per disk module	Green	No LED when the slot is empty or has a filler module. Also, off when the disk is powered down by command; for example, the result of a temperature fault.  Fast blinking when the SATA/SAS drive is powered up but not spinning; this is a normal part of the spin-up sequence, occurring during the spin-up delays of a slot.  On when the drive has power but is not handling any I/O activity (the ready state).  Slow blinking when the drive is spinning and handling I/O activity.

**Table 212. Status lights visible from front of disk enclosure (continued)**

Light	Quantity	Color	Meaning
Disk fault light	1 per disk module	Amber	On when the disk module is faulty, or as an indication to replace the drive.

## Back panel

For redundancy, the shelf has two identical power supply/cooling modules and two identical shelf controllers which are placed in reverse order.

**NOTE:** When replacing a component, note its orientation before removing it. Insert the replacement in the same position.

Power supply A and controller A are located at the bottom of the chassis, and power supply B and controller B are located at the top of the chassis.



**Figure 171. Back panel: Power modules and controllers**

1. LEDs
  - Power supply B: Power LED
  - Power fault: Amber
  - Blower fault: Amber
2. Expansion (Out)
3. Host (In)
4. Enclosure address (not used)
5. Power (Green) or Fault (Amber)
6. Bus ID (not used)
7. Host link active
8. Expansion link active
9. LEDs
  - Power supply A Power LED
  - Power fault: Amber
  - Blower fault: Amber



**Figure 172. Power Supply A LEDs**

Each shelf controller has two SAS ports. The port labeled with a circle symbol is the Host port, and the port labeled with a diamond symbol is the Expansion port. The Expansion ports are located on the outside, and the Host ports on the inside (reversed controller positions).

**Table 213. Status lights visible from rear of disk enclosure**

Light	Quantity	Color	Meaning
Controller Power	1 per Controller	Blue or Green	On when the Controller is powered on.
Controller Fault	1 per Controller	Amber	On when either the Controller or a SAS connection is faulty. On during power-on self-test
Host Link Active	1 per Controller	Blue	On when the host connection is active.
Expansion Link Active	1 per Controller	Blue	On when the expansion connection is active.
Power Supply Active	1 per power supply	Green	On when the power supply is operating.
Power Supply Fault*	1 per power supply	Amber	On when the power supply is faulty or is not receiving AC line voltage.  Flashing when either a multiple blower or ambient over temperature condition has shut off DC power to the system.
Blower Fault*	1 per power supply	Amber	On when one of the blowers in the power supply is faulty.

\*The ES30 and continue to run with a single power supply and three of its four blowers. Removing a power/cooling module constitutes a multiple blower fault condition, and powers down the shelf unless you replace a module within two minutes.

## Ports

Depending on the model, a system has one to four dual- or quad-port SAS HBA cards or SAS I/O modules installed. The ES30 shelf has two controllers (B located above A). Each controller has two ports, a host and an expansion port.

This chapter contains the following topics:

**Topics:**

- [ES40 overview](#)
- [Dimensions and weights](#)
- [Power requirements](#)
- [DAE-to-DAE copper cabling](#)
- [Product service tag](#)

## ES40 overview

Adding ES40 expansion shelves to a system increases the system's storage capacity.

The expansion shelves are organized by sets (or chains). The following table shows the number of ES40 shelves that can be in a set.

**Table 214. ES40 shelves in a set**

System (base)	ES40 shelves
DD6900	1–7
DD9400	1–7
DD9900	1–7

For redundancy, a shelf set is usually connected to two separate SAS I/O modules or HBA cards on the controller, and all of the shelves within a set are connected to each other via dual paths.

## Dimensions and weights

**Table 215. Dimensions and weight**

Dimensions	Vertical size	Weight (see note)
Height: 5.25 in (13.34 cm)	3 NEMA units	68 lb (30.8 kg) with 15 disks
Width: 17.62 in (44.75 cm)		
Depth: 14.0 in (35.6 cm)		
Note: The weight does not include mounting rails. Allow 5-10 lb (2.3-4.5 kg) for a rail set. The weights listed in this table do not describe enclosures with solid state disk drives with Flash memory (called Flash or SSD drives). These Flash drive modules weigh 20.8 ounces (1.3 lb) each.		

## Power requirements

The input current, power (VA), and dissipation per enclosure listed in this document are based on measurements of fully configured enclosures under worst-case operating conditions. Use the operating maximum values to plan the configuration of your storage system. These values represent either:

- the values for a single power supply line cord, or

- the sum of the values shared by the line cords of the combined power supplies in the same enclosure, with the division between the line cords and supplies at the current sharing ratio (approximately 50% each).

A failure of one of the combined power supplies per enclosure results in the remaining power supply supporting the full load. You must use a rackmount cabinet or rack with appropriate power distribution, and have main branch AC distribution that can handle these values for each enclosure in the cabinet.

**Table 216. AC power specifications**

Requirement	Description
AC line voltage	100 to 240V AC $\pm$ 10%, single-phase, 47 to 63 Hz
AC line current (operating maximum)	2.9 A max at 100V AC
	1.6 A max at 200V AC
Power consumption (operating maximum)	287 VA (281 W) max at 100V AC
	313 VA (277 W) max at 200V AC
Power factor	0.9 min at full load at 100V AC
	0.9 min at full load at 200V AC
Heat dissipation (operating maximum)	$1.01 \times 10^6$ J/hr (959 Btu/hr) max at 100V AC
	$1.01 \times 10^6$ J/hr (945 Btu/hr) max at 200V AC
In-rush current	30 A max for $\frac{1}{2}$ line cycle, per line cord at 240V AC
Startup surge current	25 A peak max per line cord, max at any line voltage
AC protection	10 A fuse on each power supply, both Line and Neutral
AC inlet type	IEC320-C14 appliance coupler, per power zone
Ride-through time	30 ms min
Current sharing	Droop Load Sharing
<p><b>NOTE:</b></p> <ul style="list-style-type: none"> <li>Ratings assume a fully loaded DAE that includes 2 power supplies and 12 worst case disk drive slot numbers.</li> <li>All power figures shown represent max normal operating numbers with the chassis running in a normal 20°C to 25°C ambient temperature environment. The chassis power numbers given may increase when running in a higher ambient temperature environment.</li> <li>For specific product configuration power numbers, refer to the EMC Power Calculator located on the internet at <a href="https://powercalculator.emc.com">https://powercalculator.emc.com</a>. The Power Calculator will provide the chassis power delta when operating in different ambient temperature ranges and configurations. However, it will only support products with an input voltage range of 200-240V ac.</li> </ul>	

**Table 217. DC power specifications**

Requirement	Description
DC line voltage	-39 to -72V DC (nominal -48 or -60 V power systems)
DC line current (operating maximum)	7.92 A max at -39V DC
	6.43 A max at -48V DC
	4.39 A max at -72V DC
Power consumption (operating maximum)	309 W max at -39V DC
	309 W max at -48V DC
	316 W max at -72V DC
Heat dissipation (operating maximum)	$1.11 \times 10^6$ J/hr (1054 Btu/hr) max at -39V DC
	$1.11 \times 10^6$ J/hr (1054 Btu/hr) max at -48V DC

**Table 217. DC power specifications (continued)**

Requirement	Description
	1.14 x 10 <sup>6</sup> J/hr (1078 Btu/hr) max at -72V DC
In-rush current	20 A peak per requirements in EN300 132-2 Sect 4.7 limit curve
DC protection	20 A fuse in each power supply
DC inlet type	Positronics PLB3W3M1000
Mating DC connector	Positronics PLB3W3F7100A1
	Positronics Inc.
	<a href="http://www.connectpositronic.com">http://www.connectpositronic.com</a>
Ride-through time	5 ms min. (test condition: Vin = -40V DC)
Current sharing	Droop Load Sharing
<p><b>NOTE:</b></p> <ul style="list-style-type: none"> <li>• Ratings assume a fully loaded DAE that includes 2 power supplies and 15 maximum disk slot numbers.</li> <li>• All power figures shown represent max normal operating numbers with the chassis running in a normal 20°C to 25°C ambient temperature environment. The chassis power numbers given may increase when running in a higher ambient temperature environment.</li> <li>• The EMC Power Calculator does not support DC chassis.</li> </ul>	

## DAE-to-DAE copper cabling

The expansion port interface to and between DAEs is copper cabling. The 100 Ω cables are keyed at either end, and available in 1- 10-meter lengths.

- DAE-to-DAE cables are SFF 8088 mini-SAS to mini-SAS.
- Keys are defined in the T10-SAS 2.1 specification.

## Product service tag

The serial number is seven alphanumeric characters and found on the service tag.

This chapter contains the following topics:

**Topics:**

- [Overview of FS15 SSD drives](#)
- [Site requirements](#)
- [FS15 hardware specifications](#)
- [FS15 front panel](#)
- [Back panel](#)
- [Status LEDs](#)


## Overview of FS15 SSD drives

The FS15 is an external shelf consisting of a specific number of SSD drives, depending upon the system, and are used to cache meta-data.

The SSDs for the FS15 shelf are 800GB 3WPD devices, which have positive performance and longevity characteristics.

**Table 218. Number of SSD drives and model compatibility**

Number of Drives	Model
2	DD6300 with HA
5	<ul style="list-style-type: none"> <li>• DD6800 with HA</li> <li>• DD9300 with HA</li> </ul>
8	<ul style="list-style-type: none"> <li>• DD9300 with HA</li> <li>• DD9500 - with or without HA</li> </ul>
15	DD9500 - with or without HA

 **NOTE:** Unused drive slots have drive fillers to improve airflow.

There are also upgrade kits available to add more SSDs if a system is expanded to have additional memory.

Upgrade Pack	Use
3 Drive Upgrade Pack	To create a 5 drive shelf from originally a 2 drive shelf or an 8 drive shelf from originally a 5 drive shelf
7 Drive Upgrade Pack	To create a 15 drive shelf from an 8 drive shelf

## Site requirements

This table lists the FS15 site requirements.

**Table 219. FS15 site requirements**

Requirement	FS15 shelf
Vertical Space in Standard 19", 4-post Rack	3U. Do not use a two-post rack. See the slide rail and installation documentation in the packaging for installing in a rack.
Air Conditioning	Air conditioning that can cope with the maximum BTU/hr thermal rating.



**Table 219. FS15 site requirements (continued)**

Requirement	FS15 shelf
Temperature Controls	Adequate temperature control with a gradient (change) not to exceed 30° C in an hour.
Front Bezel Clearance	1.56 inches (4.0 cm) of unobstructed clearance.
Back Panel Clearance	5 inches (12.7 cm) of unobstructed clearance.
Airflow	In a closed or multi-unit rack, ensure that the unit has adequate airflow. If the equipment is mounted in an enclosed (as opposed to a four-post open rack), the front and rear doors should have 65% minimum open area for airflow. Whether in an open or enclosed rack, use filler panels to prevent hot air recirculation. The rack design and installation should take into consideration the maximum ambient operating temperature of the equipment, which is 35° C.
Power/ Grounding	Two single-phase AC power outlets with an earth ground conductor (safety ground). A safe electrical earth connection must be provided to each power cord. Voltage should be 100-120 VAC or 200-240 VAC; 50 or 60 Hz. Use only with branch circuits protected by a minimum 15A overcurrent protector. Plug the two power cords into separate branch circuit supplies for redundancy.

## FS15 hardware specifications

**NOTE:** All ratings assume a fully configured FS15.

**Table 220. FS15 hardware specifications**

Specification	Description
AC line voltage	100 to 240 Vac ± 10%, single-phase, 47 to 63 Hz
AC line current (operating maximum)	2.8 A max at 100 Vac, 1.4 A max at 200 Vac
Power consumption (operating maximum)	280 VA (235 W) max
Power factor	0.98 min at full load, low voltage
Heat dissipation (operating maximum)	8.46 x 10 <sup>5</sup> J/hr, (800 Btu/hr) max
Dimensions (rack mounted, with bezel)	<ul style="list-style-type: none"> <li>Width: 17.62" (45 cm) Depth: 14" (35.56cm)</li> <li>Height: 5.25" (13.34cm) 3 RU</li> </ul>
Maximum Weight	68 lbs (30.8 kg)
Operating Temperature	<ul style="list-style-type: none"> <li>Ambient temperature: 10° C to 35° C (50° F to 95° F)</li> <li>Temperature gradient: 10° C/hr (180° F/hr)</li> <li>Relative humidity extremes: 20% to 80% noncondensing</li> </ul>
Recommended Operating Relative Humidity	40% to 55% noncondensing
Non-Operating Temperature	<ul style="list-style-type: none"> <li>Ambient temperature: -40° C to 65° C (-40° F to 149° F)</li> <li>Temperature gradient: 25° C/hr (45° F/hr)</li> <li>Relative humidity: 10% to 90% noncondensing</li> </ul>

## FS15 front panel

After you unlock and remove the snap-on bezel on the front panel, the 15 disks are visible. Disk numbers, as reported by system commands, range from 1 to 15. When facing the front panel, Disk 1 is located in the leftmost slot in the enclosure and Disk 15 in the rightmost slot.



**Figure 173. FS15 front panel (bezel removed)**

**NOTE:** The flanges or sheet metal on the FS15 show 0 to 14 but the software will refer to the logical numbering of 1 to 15.

Each disk in the enclosure has two LEDs. The disk's active LED glows green when the disk is functional. The disk fault LED glows amber when the disk has failed.

If there is a problem with the enclosure, the enclosure fault light is amber. The disk enclosure power light should be on (blue) when the shelf is powered on.

When replacing FS15 disks, a good practice is to run this command:

```
disk beacon <enclosure-id>.<disk-id>
```

**NOTE:** The `disk beacon` command causes the LED that signals normal operation to flash on the target disk. Enter `Ctrl-C` to stop the flash. You can also use the `enclosure beacon` command to check the LED to blink on every disk.



**Figure 174. Front panel LEDs**

1. Disk enclosure fault light
2. Disk enclosure power light
3. Disk active light
4. Disk fault light

**Table 221. Status lights visible from front of disk enclosure**

Light	Quantity	Color	Meaning
Disk enclosure fault light	1	Amber	On when any fault condition exists; if the fault is not obvious from a disk module light, look at the back of the disk enclosure.
Disk enclosure power light	1	Blue	Power to enclosure is on.
Disk active light	1 per disk module	Green	No LED when the slot is empty or has a filler module. Also, off when the disk is powered down by command; for example, the result of a temperature fault.

**Table 221. Status lights visible from front of disk enclosure (continued)**

Light	Quantity	Color	Meaning
			<p>Fast blinking when the SATA/SAS drive is powered up but not spinning; this is a normal part of the spin-up sequence, occurring during the spin-up delays of a slot.</p> <p>On when the drive has power but is not handling any I/O activity (the ready state).</p> <p>Slow blinking when the drive is spinning and handling I/O activity.</p>
Disk fault light	1 per disk module	Amber	On when the disk module is faulty, or as an indication to replace the drive.

## Back panel

For redundancy, the shelf has two identical power supply/cooling modules and two identical shelf controllers which are placed in reverse order.

**NOTE:** When replacing a component, note its orientation before removing it. Insert the replacement in the same position.

Power supply A and controller A are located at the bottom of the chassis, and power supply B and controller B are located at the top of the chassis.



**Figure 175. Back panel: Power modules and controllers**

1. LEDs
  - Power supply B: Power LED
  - Power fault: Amber
  - Blower fault: Amber
2. Expansion (Out)
3. Host (In)
4. Enclosure address (not used)
5. Power (Green) or Fault (Amber)
6. Bus ID (not used)
7. Host link active
8. Expansion link active
9. LEDs
  - Power supply A Power LED
  - Power fault: Amber
  - Blower fault: Amber



**Figure 176. Power Supply A LEDs**

Each shelf controller has two SAS ports. The port labeled with a circle symbol is the Host port, and the port labeled with a diamond symbol is the Expansion port. The Expansion ports are located on the outside, and the Host ports on the inside (reversed controller positions).

**Table 222. Status lights visible from rear of disk enclosure**

Light	Quantity	Color	Meaning
Controller Power	1 per Controller	Blue or Green	On when the Controller is powered on.
Controller Fault	1 per Controller	Amber	On when either the Controller or a SAS connection is faulty. On during power-on self-test
Host Link Active	1 per Controller	Blue	On when the host connection is active.
Expansion Link Active	1 per Controller	Blue	On when the expansion connection is active.
Power Supply Active	1 per power supply	Green	On when the power supply is operating.
Power Supply Fault*	1 per power supply	Amber	On when the power supply is faulty or is not receiving AC line voltage.  Flashing when either a multiple blower or ambient over temperature condition has shut off DC power to the system.
Blower Fault*	1 per power supply	Amber	On when one of the blowers in the power supply is faulty.

\*The ES30 and continue to run with a single power supply and three of its four blowers. Removing a power/cooling module constitutes a multiple blower fault condition, and powers down the shelf unless you replace a module within two minutes.

## Status LEDs

Verify the status by checking the LEDs. Controller B is located above Controller A in the center of the rear panel. The power supply/cooling units are above and below the controllers.

Facing the back panel of the FS15, the Expander ports are the outer of the two ports; the Host ports are the inner of the two ports. The ports are identified by symbols on the rear panel: a circle symbol indicates a Host port; a diamond symbol indicates an Expander port.

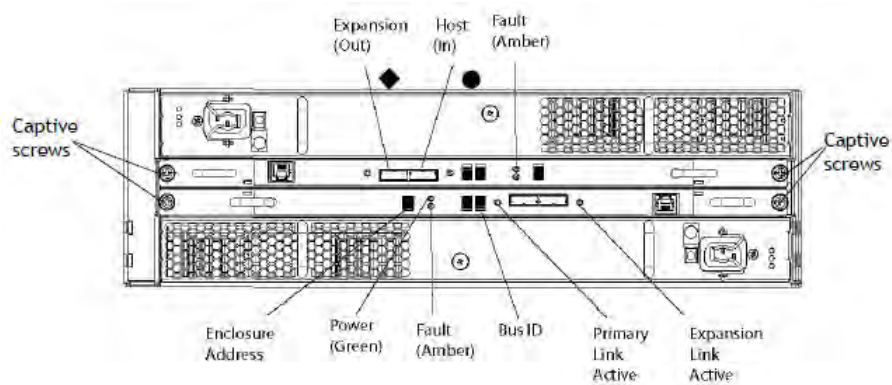


Figure 177. Rear panel overview

Table 223. Status LEDs

Light	Quantity	Color	Meaning
Controller power	1 per controller	Green	On when the controller is powered on
Controller failure	1 per controller	Amber	On when either the controller or a SAS connection has failed. On during a power-on self test.
Host link active	1 per controller	Blue	On when the host connection is active
Expansion link active	1 per controller	Blue	On when the expansion host is active

This chapter contains the following topics:

**Topics:**

- [Overview of FS25 SSD drives](#)
- [Dimensions and weight](#)
- [Power requirements](#)
- [DAE-to-DAE copper cabling](#)
- [Product service tag](#)

## Overview of FS25 SSD drives

The FS25 is an external shelf consisting of a specific number of SSD drives, depending upon the system, and are used to cache meta-data.

**Table 224. Number of SSD drives and model compatibility**

Number of Drives	Model
2	DD6900 only with HA
5	DD9400 only with HA
10	DD9900

**NOTE:** Unused drive slots have drive fillers to improve airflow.

## Dimensions and weight

**Table 225. Dimensions and weight**

Dimensions	Vertical size	Weight (see note)
Height: 3.40 in (8.64 cm)	2 NEMA units	44.61 lb (20.23 kg) with 25 disks
Width: 17.50 in (44.45 cm)		
Depth: 14.0 in (35.56 cm)		
Note: The weight does not include mounting rails. Allow 5-10 lb (2.3-4.5 kg) for a rail set. The weights listed in this table do not describe enclosures with solid state disk drives with Flash memory (called Flash or SSD drives). These Flash drive modules weigh 20.8 ounces (1.3 lb) each.		

## Power requirements

The input current, power (VA), and heat dissipation per enclosure listed in this document are based on measurements of fully configured enclosures under worst-case operating conditions. Use the operating maximum values to plan the configuration of your storage system. These values represent either:

- values for a single power supply line cord, or
- the sum of the values shared by the line cords of the combined power supplies in the same enclosure, with the division between the line cords and supplies at the current sharing ratio (approximately 50% each).

A failure of one of the combined power supplies per enclosure results in the remaining power supply supporting the full load. You must use a rackmount cabinet or rack with appropriate power distribution, and have main branch AC distribution that can handle these values for each enclosure in the cabinet.

**Table 226. AC power specifications**

Requirement	Description
AC line voltage	100 to 240V AC ± 10%, single-phase, 47 to 63 Hz
AC line current (operating maximum)	4.5 A max at 100V AC
	2.4 A max at 200V AC
Power consumption (operating maximum)	453 VA (432 W) max, at 100V AC
	585 VA (427 W) max, at 200V AC
Power factor	0.95 min at full load, @ 100V AC
	0.95 min at full load, @ 200Vac
Heat dissipation (normal operating maximum)	1.56 x 10 <sup>6</sup> J/hr. (1,474 Btu/hr.) max @ 100V AC
	1.54 x 10 <sup>6</sup> J/hr. (1,457 Btu/hr) max @ 200Vac
In-rush current	30 Apk "cold" per line cord at any line voltage
Startup surge current	40 Apk "hot" per line cord, at any line voltage
AC protection	15 A fuse on each power supply, single line
AC inlet type	IEC320-C14 appliance coupler, per power zone
Ride-through time	12 ms min
Current sharing	± 5% of full load, between power supplies
<p><b>NOTE:</b></p> <ul style="list-style-type: none"> <li>• Ratings assume a fully loaded DAE that includes 2 power supplies and 25 worst case disk drive slot numbers.</li> <li>• All power figures shown represent max normal operating numbers with the chassis running in a normal 20°C to 25°C ambient temperature environment. The chassis power numbers given may increase when running in a higher ambient temperature environment.</li> <li>• For specific product configuration power numbers, refer to the EMC Power Calculator located on the internet at <a href="https://powercalculator.emc.com">https://powercalculator.emc.com</a>. The Power Calculator will provide the chassis power delta when operating in different ambient temperature ranges and configurations. However, it will only support products with an input voltage range of 200-240V ac.</li> </ul>	

**Table 227. DC power specifications**

Requirement	Description
DC line voltage	-39 to -72V DC (nominal -48 or -60 V power systems)
DC line current (operating maximum)	11.0 A max at -39V DC
	9.10 A max at -48V DC
	6.20 A max at -72V DC
Power consumption (operating maximum)	428 W max at -39V DC
	437 W max at -48V DC
	448 W max at -72V DC
Heat dissipation (operating maximum)	1.54 x 10 <sup>6</sup> J/hr (1460 Btu/hr) max at -39V DC
	1.57 x 10 <sup>6</sup> J/hr (1491 Btu/hr) max at -48V DC
	1.61 x 10 <sup>6</sup> J/hr (1529 Btu/hr) max at -72V DC
In-rush current	40 A peak per requirements in EN300 132-2 Sect 4.7 limit curve



**Table 227. DC power specifications (continued)**

Requirement	Description
DC protection	50 A fuse in each power supply
DC inlet type	Positronics PLBH3W3M4B0A1/AA
Mating DC connector	Positronics PLBH3W3F0000/AA
	Positronics Inc.
	<a href="http://www.connectpositronic.com">http://www.connectpositronic.com</a>
Ride-through time	1 ms min. at -50V input
Current sharing	±5% of full load, between power supplies

- NOTE:**
- Ratings assume a fully loaded DAE that includes 2 power supplies and 25 maximum disk slot numbers.
  - All power figures shown represent max normal operating numbers with the chassis running in a normal 20°C to 25°C ambient temperature environment. The chassis power numbers given may increase when running in a higher ambient temperature environment.
  - The EMC Power Calculator does not support DC chassis.

## DAE-to-DAE copper cabling

The expansion port interface to and between DAEs is copper cabling. The 100 Ω cables are keyed at either end, and available in 1- 10-meter lengths.

- DAE-to-DAE cables are SFF 8088 mini-SAS to mini-SAS.
- Keys are defined in the T10-SAS 2.1 specification.

## Product service tag

The serial number is seven alphanumeric characters and found on the service tag.

# Index

## S

Specifications

power requirements [277](#)