



**EMC® NetWorker®
Release 7.6 Service Pack 3**

Administration Guide

P/N 300-013-301

REV A04

EMC Corporation

Corporate Headquarters:
Hopkinton, MA 01748-9103

1-508-435-1000

www.EMC.com

Copyright © 1990 - 2011 EMC Corporation. All rights reserved.

Published May 25, 2012

EMC believes the information in this publication is accurate as of its publication date. The information is subject to change without notice.

THE INFORMATION IN THIS PUBLICATION IS PROVIDED "AS IS." EMC CORPORATION MAKES NO REPRESENTATIONS OR WARRANTIES OF ANY KIND WITH RESPECT TO THE INFORMATION IN THIS PUBLICATION, AND SPECIFICALLY DISCLAIMS IMPLIED WARRANTIES OF MERCHANTABILITY OR FITNESS FOR A PARTICULAR PURPOSE.

Use, copying, and distribution of any EMC software described in this publication requires an applicable software license.

For the most up-to-date listing of EMC product names, see EMC Corporation Trademarks on EMC.com.

All other trademarks used herein are the property of their respective owners.

Preface

Audience 25
 NetWorker product documentation 25
 NetWorker related documentation 26
 Conventions used in this document 27

Chapter 1

Overview

The EMC NetWorker environment 30
 NetWorker components 30
 NetWorker features 32
 Performance features 32
 Ease of use 33
 Scalability 33
 Optional software additions 34
 IPv4 to IPv6 transition 34
 Common NetWorker tasks 34
 How to add a new host 34
 How to schedule a backup 35
 How to configure devices 35
 How to label media 35
 How to view failed backups 36
 NetWorker user interfaces 36
 NetWorker Management Console interface 36
 NetWorker client interface 43
 NetWorker character-based interface 48
 NetWorker command-line interface 48
 NetWorker services 48
 Services and programs on the NetWorker server 49
 Services and programs on the NetWorker client 49

Chapter 2

Backing Up Data

Scheduled backups 54
 Planning a scheduled backup 54
 Setting up a scheduled backup 55
 Save sets 61
 Scheduling predefined save sets for backup 61
 The All save set 62
 Manual backups 64

Performing a manual backup on Windows	64
Performing a manual backup from the command prompt	67
Verifying backed-up data	69
Probe-based backups	69
Checkpoint restart backups	69
About partial save sets	71
Configuring checkpoint enabled clients	71
Monitoring checkpoint enabled backups	72
Restarting a checkpoint enabled backup	73
How to query partial save sets from the Console	74
How to query partial save sets using the mminfo command	74
Recovering data.....	75
Cloning and scanning partial savesets.....	76
Cloud backup devices and partial savesets	76
Deduplication backups.....	76
BMR backups	77
Encrypting backup data	77
Set the Datazone pass phrase for a NetWorker server	77
Apply AES data encryption to clients in the datazone.....	77
Compressing backup data	78
Applying compression to a scheduled backup	78
Applying compression to a manual backup	78
Special data handling for NetWorker clients on Windows	78
Backing up NetWorker Console Management data.....	79
Scheduling backups for the NetWorker Console database	79
Performing a manual backup of the Console database.....	80
Managing the size of the Console database log file	80
Backing up Windows mount points.....	81
Including mount points in scheduled backups	81
Performing a manual backup of a mount point and its data	81
Performing a manual backup of nested mount points and their data	82
Backing up the Windows Content Index Server.....	82
Backing up CIS on Windows.....	82
Directing NetWorker software to skip CIS catalog backups	83
Backing up Windows DHCP and WINS databases	83
Backing up a DHCP database	83
Backing up a WINS database	84
Windows backup and recovery notes	84
Enabling short filename support	84
Enabling hard link support	85
Recovery and case-sensitivity	85
Failed backup and recovery attempts.....	85
Granting full permissions for backup of Disk Quota database.....	85
Security settings for logging operations performed by backup operator.....	86
Customizing the backup command	86
Using the save command with a customized backup script	87
Using the savenpc command with a customized backup program.....	91
Considerations for backing up raw partitions	94
Backing up raw partitions on UNIX.....	94
Backing up raw partitions on Windows.....	95
Backing up a mapped drive.....	95
Backing up access control lists	95
Backing up BOOT/BCD Data on Windows 2008R2 and Windows 7.....	95
Support for backing up renamed directories	96
Backing up only client file indexes and the bootstrap	96

Chapter 3	Configuring Libraries and Devices	
	Devices and libraries	98
	Support for LTO-4 hardware-based encryption	98
	Storage nodes	99
	Prerequisites	99
	Licensing	99
	Storage node configuration	99
	Configuring a storage node	100
	Modifying timeout attribute for storage node operations.....	100
	Timeouts for storage node remote devices	101
	Storage node affinity	101
	Dedicated storage nodes.....	102
	Tips for troubleshooting storage nodes.....	103
	Data Domain deduplication devices.....	104
	Avamar deduplication nodes and replication nodes.....	104
	Dynamic drive sharing	104
	Introduction to DDS.....	104
	Block-size compatibility.....	105
	SCSI Reserve/Release	106
	Enabling DDS with NDMP	108
	DDS attributes in the device properties	108
	High availability and DDS	109
	Licensing	110
	Autodetection of libraries and devices.....	110
	Scanning for libraries and devices	110
	Configuring the Sun StorEdge Network Foundation HBA/Driver	111
	Add (configure) libraries	113
	How to add a library device	114
	Queuing device resources for AlphaStor	116
	Virtual Tape Library (VTL) configuration	116
	Library reconfiguration.....	117
	Reconfiguring a library	117
	Using the jbedit command	117
	Add (configure) stand-alone devices.....	118
	Autodetecting and configuring a stand-alone tape drive	118
	Adding a stand-alone device manually	119
	Configuring NetWorker DiskBackup.....	120
	Support for cloud backup devices.....	120
	Cloud backup devices compared to other device types	120
	Cloud backup prerequisites and considerations	120
	Cloud best practices	121
	Creating and labeling a cloud storage device	122
	Gathering report information on cloud backup.....	124
	Staging with a cloud storage device	125
	Cloning to a cloud storage device	125
	Deleting libraries and devices.....	125
	How to delete a library	125
	How to delete a device.....	125
	Library slots	126
	How to configure library slots.....	126
	Troubleshooting autoconfiguration failure.....	126
Chapter 4	Backup Groups and Schedules	
	Overview of NetWorker scheduling.....	130

Backup groups	130
The NetWorker server and time-based backup groups	130
Creating and scheduling a probe group	132
Preconfigured groups	133
Key Group attributes	133
Aborted backup groups	134
How to create a group	134
How to edit a group	134
How to delete a group	135
How to copy a group	135
Setting the backup group time interval	135
Limiting full backups when the time interval is less than 24 hours	136
Managing backup groups	137
Previewing a backup group	137
Moving clients between groups	137
Estimating save set sizes of a backup group	138
Backing up status reports	138
Generating and printing bootstrap reports	138
Backing up open files	139
Opening files owned by the operating system	139
Opening files owned by a specific application	139
Files that change during backup	140
Backing up open files with VSS	140
Schedules	140
Schedules for Avamar deduplication clients	140
Preconfigured NetWorker schedules	141
Backup cycles	141
Scheduling and planning considerations	143
Scheduling large client file systems	143
Key components of a schedule	144
Working with schedules	145
Overriding a client's regular backup schedule	145
Client timezone adjustment for Windows clients	146
Backup levels	147
How NetWorker backup levels work	147
The NetWorker server and backup levels	149
Backup levels for Windows SYSTEM and VSS SYSTEM save sets	151
Save set consolidation	153
Requirements	154
Save set consolidation usage	154
Limitations of save set consolidation	154
Performing save set consolidation	155
Setting up save set consolidation on a schedule	155
Directing data from a consolidation backup to a specific pool	155

Chapter 5 Browse and Retention Policies

About browse and retention policies	158
Browse policies	158
Retention policies	160
Managing the data lifecycle	162
Assigning multiple policies to a single client	164
Preconfigured policies	164
Editing a policy	165
Delete a policy	165

	Snapshot policies	165
	Working with snapshot policies.....	166
	Browse and retention policies for manual backups.....	167
	Modifying the browse and retention policy on a save set.....	168
	Reports on browse and retention policies for save sets	168
Chapter 6	Directives	
	Directives overview	170
	Types of local and global directives	170
	Global directives	170
	NetWorker User local directives (Windows only)	170
	Local directive files.....	170
	Creating a global directive resource.....	170
	Editing a global directive resource.....	171
	Deleting a global directive resource.....	171
	Copying a global directive resource.....	171
	Applying directives	172
	Order of precedence of global and local directives	173
	Local directives within the NetWorker User program	173
	Set up a NetWorker User program local directive	173
	Preconfigured global directive resources	174
	Format of directive statements	176
	Directory specifications	176
	Precautions when using rawasm to back up UNIX raw partitions	180
	File matching with multiple ASMs in a directive	180
Chapter 7	Sorting Backup Data	
	Media pools	184
	Using media pools.....	184
	NetWorker media pool types	184
	Sorting data with media pools.....	185
	Directing client file indexes and bootstrap to a separate media pool.....	186
	Directing consolidated backup data to a specific media pool	187
	Meeting the criteria for more than one media pool configuration.....	187
	When no customized media pool criteria is met	188
	Configuring media pools.....	189
	Using storage devices and media pool configuration to sort data.....	190
	Creating a media pool.....	191
	Supporting WORM and DLTWORM tape drives	192
	Working with media pools.....	195
	Label templates	197
	Using label templates.....	197
	Using preconfigured label templates.....	197
	Completing Label Template attributes.....	198
	Naming label templates.....	199
	Working with label templates.....	200
Chapter 8	Archiving	
	Overview of archiving	204
	Archive requirements	204
	How the NetWorker server archives data	204
	Indexed and nonindexed archiving.....	205
	Permissions for archiving.....	206

Enabling archive services for the client	206
Enabling or restricting archive access	206
Enabling public archive access.....	207
About archive pools.....	207
Preconfigured Indexed Archive pool and PC Archive pool.....	207
Preconfigured archive pool	207
Creating custom Archive pools.....	207
Archiving data procedures	208
Enabling archive services for a NetWorker client.....	208
Manually archiving data.....	208
Scheduling data archives	209
Retrieving archived data	212
Retrieval permissions	212
Retrieving nonindexed archives from a client on Windows	212
Retrieving nonindexed archives from a client on UNIX.....	213
Recovering indexed archive data from a client on Windows	213
Recovering indexed archive data from a client on UNIX	214
Retrieving archive data from the command prompt.....	214
Archive request management.....	215
Starting a scheduled archive at any time.....	215
Stopping a scheduled archive while in progress.....	215
Disabling a scheduled archive	215
Viewing details of a scheduled archive	215

Chapter 9 Cloning

Overview of cloning	218
Cloning requirements.....	218
Save set cloning	218
Considerations for scheduled clone jobs	219
Setting up a schedule clone job	220
Starting a scheduled clone job manually	222
Monitoring scheduled clone jobs.....	222
Setting up automatic cloning from a backup group	222
Viewing the clone status of a save set.....	223
Cloning a save set manually.....	223
Additional manual clone operations.....	225
Specifying browse and retention policies for clone data.....	226
Specify a browse and retention policy in a scheduled clone job.....	226
Specify a browse and retention policy from the command prompt.....	226
Specify a retention policy for a Clone pool	226
Volume cloning.....	227
Creating a clone volume	227
Viewing clone volume details.....	227
Recovering cloned data	227
Recovering a cloned save set from the command prompt.....	228
Recovering a save set when all cloned instances have expired	228
Cloning archived data	229
Directing clones to a special storage node.....	229
Storage node selection criteria for reading the clone data	229
Storage node selection criteria for writing the clone	231
Storage node selection criteria for recovering cloned data.....	232
Using file type devices for clone operations	233
Differences in the cloning process.....	233
Manual cloning with advanced file type device	233

	Backup-to-tape for Avamar deduplication clients	233
	Cloning with Data Domain devices	233
	Using the nsrclone command	234
Chapter 10	Staging Backups	
	Save set staging	236
	Working with staging policies	236
	Creating a staging policy	236
	Editing a staging policy	238
	Copying a staging resource.....	238
	Deleting a staging policy	239
	Consideration for staging a bootstrap backup	239
	Staging and cloning from the command prompt	239
Chapter 11	Device Operations	
	Overview of device operations	242
	File type (FTD) and advanced file type (AFTD) devices.....	242
	DiskBackup and staging	243
	Differences between FTDs and AFTDs	244
	File type devices.....	245
	Creating and configuring FTDs and AFTDs	247
	Task 1: Set the AFTD allowed directories attribute.....	247
	Task 2: Create and configure an FTD and AFTD device	247
	Task 3: Provide sufficient disk space for the AFTD	252
	Task 4: (Optional) Share an AFTD between storage nodes in a NAS or SAN environment	254
	Task 5: Verify FTD and AFTD operations	257
	Create CIFS-mounted AFTD on Windows servers and storage nodes.....	258
	Start the NetWorker service on Microsoft Windows	258
	Configure CIFS-mapped AFTD on Windows server and storage node	258
	Recover savesets by using AFTD concurrent operations.....	260
	Limitations with concurrent AFTD recovery operations	260
	Delete FTD and AFTD	261
	License NetWorker DiskBackup solutions.....	261
	Device target and max sessions default values and ranges.....	261
	Compatible block size for UNIX and Windows	261
	Determine the allowable block size	261
	Set the block size for a device type	262
	Device block size for read and write operations.....	262
	Library device maintenance	262
	Periodic maintenance.....	262
	Automatic tape device cleaning	263
	Tape alert	264
	Service mode	265
	Device parameter settings	265
	Device settings in the NetWorker Administration interface.....	266
	Device settings as environment variables.....	266
	Common device interface.....	268
	Device ordering.....	269
	Persistent binding and naming.....	270
	Detecting device ordering issues.....	270
	Correcting drive ordering changes	271
	Nonrewinding tape device usage (UNIX/Linux only).....	272

Block-size mode (UNIX/Linux only).....	272
Silos	272
NetWorker software interactions with a silo	273
Installing a silo.....	273
Naming conventions for silo devices	273
Releasing a silo device.....	275
Cleaning silo devices	276
Environment variables for DAS and StorageTek silos	276
Miscellaneous device operations	277
Refreshing enterprise library views on request.....	277
Changing the polling interval for enterprise library views	277
Stopping a device operation.....	278
Display device operations messages	278
Sharing libraries among NetWorker hosts.....	278
Sleeping periods for library tasks	279
Server Network Interface attribute.....	279
Tips for using libraries	280
Library notifications	280
Recycling compared to adding more volumes	280
Resetting a library	281
Using pools with libraries.....	282
Device calibration.....	282
Reordering tape drive numbers (Microsoft Windows only)	282
Adding and removing media by using the library front panel.....	282

Chapter 12 Media Management

Storage management operations.....	286
How the NetWorker server uses volume labels.....	286
How the NetWorker server selects a volume	286
Auto Media Management	288
Using Auto Media Management	288
Volume operations	289
Using the read-only mode	291
Changing a volume's mode.....	291
Recycling volumes	292
Labeling volumes	292
Using barcode labels.....	294
Mounting and unmounting volumes.....	296
Using libraries with a volume import and export capability	300
Inventorying library volumes	301
Working with volumes.....	302
Media handling errors	304
Reenable a device	304
Media management in a silo.....	305
Numbering a silo slot	305
Mounting and unmounting silo volumes	305
Labeling a silo volume	305
Using a silo with volume import/export capability.....	306
Barcode IDs	307
Inventorying a silo	309
Volume save sets.....	310
Viewing save set details in the Volume Save Sets window	310
Viewing save set details from the Save Set detail table.....	311

Chapter 13 Recovering Data

Choosing a recovery method	316
When to recover by file selection	316
When to recover by save set selection	316
Recovering by file selection.....	317
Recovering data on UNIX systems	317
Recovering data on Windows systems.....	318
Recovering data from the command prompt.....	319
Recovering an earlier version of a file	320
Relocating recovered data	323
Viewing versions of a directory or file	323
Searching for a recoverable file	324
Viewing the volumes required for data recovery.....	324
Recovering by save set selection.....	325
Recover a save set on Windows	325
Recover a save set on UNIX.....	326
Recover a save set from the command prompt.....	326
Recover individual files or directories from a save set on Windows	326
Recover individual files or directories from a save set on UNIX	326
View volumes required for save set recovery	327
Relocate recovered save set data	327
Resolve conflicts with recovered save set data	327
Recovering deduplication data.....	328
Recovering with BMR	328
Recovering encrypted data.....	328
Disaster recovery	329
Notes on the use of the scanner program	329
Directing recoveries to another client	329
Uses for directed recovery.....	330
Requirements for directed recovery	331
Enabling directed recoveries.....	331
Perform a directed recovery between Windows clients from the GUI ..	333
Perform a directed recovery between UNIX clients from the GUI	334
Perform a directed recovery from the command line.....	335
Recovering online indexes for a NetWorker server	337
Recover a client file index.....	337
Restore a save set entry in the online indexes	338
Restoring a save set entry to the client file index only.....	338
Recovering the Console database.....	340
Recovering backed-up client files from an old NetWorker server	340
Recovering the Windows system configuration	341
Temporary disk space.....	342
Recovering the Windows SYSTEM from the command prompt	343
Point-in-time recovery of the SYSTEM and VSS SYSTEM save sets.....	344
Point-in-time recovery of Microsoft SQL Server or Exchange Server from earlier versions of NetWorker	345
Preparing to recover the Windows SYSTEM STATE save set	346
Preparing to recover the SYSTEM DB save set	346
Recovering Windows volume mount points	347
Recovering mount points	347
Recovering a mount point and its data	347
Recovering Windows DHCP and WINS databases.....	348
Recover a DHCP database	348
Recover a WINS database	348
Restoring Windows Content Index Server on Windows	348

	Restoring BOOT/BCD Data on Windows 2008 R2 and Windows 7	350
Chapter 14	Reporting	
	Gathering report data	352
	Enabling/Disabling the gathering of report data	352
	Data retention and expiration policies	353
	Setting expiration policies for data retention	354
	Running a jobquery.....	354
	Report categories	355
	Report types	356
	Basic reports.....	356
	Drill-down reports	357
	Customized reports	357
	Configuring reports	357
	How to configure a report	358
	Date and time formats	358
	Input formats	359
	Viewing reports	360
	View reports.....	360
	Interactive mode.....	360
	Document mode	362
	Interactive and document mode chart types	363
	Restricting report views	366
	Background processing of reports.....	366
	Preconfigured reports	366
	NetWorker backup statistics reports.....	367
	NetWorker backup status reports	368
	NetWorker clone reports	370
	NetWorker recovery reports	372
	Data Domain statistics reports	374
	Avamar Statistics reports	374
	Event reports.....	376
	Host reports	378
	User reports.....	378
	Device reports.....	378
	Cloud backup and recover reports.....	379
	Inactive files report	380
	Customizing and saving reports	381
	Naming reports	382
	Saved file ownership and deleted users	383
	Sharing reports	383
	Sharing a report.....	383
	Exporting reports	384
	Exporting a report.....	384
	Exporting non-ASCII characters	384
	Command line reporting.....	385
	The command line reporting program	385
	Java runtime environment.....	386
	Printing reports.....	386
Chapter 15	Events and Monitoring	
	Overview of events and monitoring	388
	Events.....	388

Polling for System Events.....	388
Enabling or disabling the Capture Events option.....	389
Viewing events.....	389
Event priorities.....	390
Working with notes.....	390
Working with annotations	391
Monitoring window	392
Viewing the Monitoring window	393
Groups window	394
Clones window	396
Sessions window	397
Alerts window	397
Devices window	398
Operations window.....	399
Log window	401
Archive Requests window	401

Chapter 16 Console Server Management

Managing NetWorker Console server users	406
Login authentication for Console users	406
Adding Console users and assigning to Console roles.....	408
Restricting a Console user's view of managed servers.....	409
Granting Console users privileges on a NetWorker server	410
Resetting user preferences.....	411
Deleting a user	411
Editing user properties	412
Resetting the administrator password (native authentication only)	412
Moving the Console server.....	413
Setting system options	415
Setting a system option.....	415
Individual User Authentication	417
Setting environment variables	419
Setting environment variables on Solaris and Linux systems	419
Setting environment variables on Windows systems	420
Accessing the Console Configuration Wizard.....	420
NetWorker Console server maintenance tasks.....	421
Changing the service port used by the NetWorker Console database... ..	421
Changing database connection credentials	422
NMC server IP address/hostname updates.....	422
Displaying international fonts in non-US locale environments.....	423
NetWorker License Manager.....	423
Entering an enabler code.....	423
Deleting an enabler code	423
Entering an authorization code	423
Changing the License Manager server	424

Chapter 17 NetWorker Server Management

Enterprise	426
Enterprise components	426
Organizing NetWorker servers	426
Viewing the enterprise.....	427
Managing various servers in the enterprise	428
Managing folders in the enterprise.....	429

Adding or deleting multiple servers by using a hostname file.....	431
Configuring a NetWorker server	433
Set up the server	433
Configuring ConnectEMC	434
Configure ConnectEMC in the ConnectEMC Console.....	434
Configure ConnectEMC in NMC	435
Enabling BMR server support	436
Parallelism and multiplexing	436
Parallelism.....	437
Multiplexing	439
Managing server access.....	440
Granting access to manage NetWorker servers from Console server.....	440
Administrator privileges.....	440
NetWorker User Groups	442
Preconfigured User Groups.....	442
Customizing privileges	443
Working with User Group resources	444
Server communication issues within Microsoft Windows.....	446
Hostname determination	446
Name resolution.....	446
Backup Operators group.....	446
Dynamic Host Configuration Protocol.....	446
Backup and Recover Server service.....	446
Notifications.....	447
Preconfigured notifications	447
Customizing notifications.....	449
Logging event notifications	452
Creating a custom notification	453
Editing a notification	453
Copying a notification	453
Deleting a custom notification	454
Indexes	454
Characteristics of the online indexes.....	454
Automated index activities.....	455
Checking online indexes	455
Viewing information about the indexes	455
Index save sets	456
Querying the media database	457
Cross-checking client file indexes.....	457
Refreshing index information	457
Client file index locations.....	458
Managing the size of the online indexes	459
Querying deduplication save sets using mminfo	462
Updating NetWorker clients by using the software distribution feature	463
Message log management.....	463
Setting the UNIX startup script to trim log files.....	463
Savegroup job information	465
Internationalization.....	465
Log file viewer	465
Interoperability with previous releases of NetWorker.....	466
Display issues	466
Maximum path and save set length	466
Group completion messages	467
Locale-specific configuration issues on UNIX/Linux	467

Chapter 18 NetWorker Client Management

NetWorker client overview	470
Client configuration.....	470
Creating a client	470
Editing a client	470
Copying a client	470
Changing a client name	471
Deleting a client	471
Recovering a deleted client	472
Editing a client NSRLA database	472
Creating a client probe	473
Associating a probe with a Client resource.....	474
Configuring a client for BMR support.....	474
Lockbox pass phrase management	475
Set the Datazone pass phrase for a NetWorker server.....	475
Set the Remote access attribute for NetWorker client resource when lockbox is created for a NetWorker server on a cluster	475
Error messages and error handling for the Datazone pass phrase	475
NetWorker authentication	476
Strong authentication (nsrauth).....	476
Authentication for backwards compatibility (oldauth).....	476
Access privileges for authentication configuration	476
Specifying the minimum authentication strength between hosts.....	477
Maintaining NetWorker local host authentication credentials.....	479
Maintaining local host Peer resources.....	482
Creating a custom certificate and private key for a host	484
Multiple clients from the same computer	485
Redefining a file system into multiple client and save set instances	485
Defining a client and save set combination	485
Scheduled backups of non-ASCII files or directories.....	486
Adding or changing the NetWorker servers for a client.....	486
Editing the servers file	487
Client priority	487
Dedicated client/server interface for backup and recover operations.....	488

Chapter 19 Cluster Support

Cluster terminology.....	490
Cluster-aware and cluster-unaware NetWorker servers.....	491
Cluster licensing.....	492
Backing up data on Windows cluster environments.....	492
Backing up cluster data	492
Backing up node data	493
Backing up virtual server data	493
Backing up data on EMC AutoStart	494
Backing up the MSCS database	494
Backing up data on UNIX cluster environments	494
Configuring a scheduled save from a physical cluster client	494
Configuring a scheduled save from a virtual cluster client	495
Performing a manual backup from a virtual cluster client	496
Configuring a virtual client to back up to a local storage node.....	497
Directing a virtual client backup to a local storage node	498
Configuring a virtual client to be recovered from a local storage node	498
Directing a virtual client recovery from a local storage node.....	499
Recovering a virtual client's data by using the currechost keyword.....	499

Support for multiple IP addresses for one resource group	500
AutoStart and HACMP clusters	500
VERITAS Cluster Server	500
SUN Cluster	501
Microsoft Cluster Server (MSCS) and Microsoft Failover Cluster.....	501
Configuring an external client to a virtual server	502
Recovering data in a Windows cluster environment.....	502
How to recover data	502
Recovering data in a UNIX cluster environment	502
Recovering data from a private disk that belongs to a physical client ...	502
Recovering data from a shared disk that belongs to a virtual client	502
Recovering the Console server database	503
Tracking scheduled saves.....	503
Forcing save sets to use a specific index.....	504
Path-ownership rules	504
Using a physical storage node and virtual server on UNIX platforms.....	506
Using autochangers and stand-alone tape devices	507
Configurations for autochangers and stand-alone tape devices.....	507
DDS within a cluster.....	511
Considerations when using jbcconfig for a virtual server	514
Client Backup Configuration Wizard support requirements	515
NetWorker cluster performance issues	516
Editing the cluster cache timeout attribute	516
Setting NetWorker environment variables in a Sun cluster.....	517
Changing the default timeout of 10 minutes for the NetWorker server in a Microsoft Cluster Server or Microsoft Failover Cluster	518

Chapter 20 NetWorker Server Support for NDMP

Overview of NDMP	520
Licensing	520
NDMP connection support.....	520
Supported NDMP configurations.....	520
Local backup by using an NDMP tape server	521
Backup by using NetWorker storage node support	522
Three-party backup with NDMP tape server	524
Requirements for and limitations of NDMP support	525
Requirements for NetWorker software with NDMP support	525
Limitations of the NetWorker software with NDMP support	526
NetWorker storage node support for NDMP clients.....	528
Vendor-specific information.....	529
Configuring the NetWorker server for NDMP operations	529
Configuring library support for NDMP	530
Configuring an NDMP device resource	534
Configuring an NDMP Client resource	535
Additional considerations for NDMP operations.....	538
Performing NDMP backups	538
Tape server support for NDMP client backup	538
Performing a local backup by using the NetWorker User program	539
Performing an NDMP backup from the command prompt.....	539
Performing a three-party backup from the command prompt.....	540
Performing DAR backups.....	541
Storage node support for NDMP client backup	542
Incremental backups and token-based backup support	543
Performing NDMP recoveries	545

	Storage node support for NDMP client recovery	545
	Performing a save set recovery	546
	Destructive save set recoveries	547
	Performing a directory-level recovery	547
	Performing a file-by-file recovery	548
	Performing a directed recovery	549
	Snapmirror to tape backup and recovery	552
	Limitations and Guidelines	552
	SMTAPE Configuration	552
	Commands and descriptions	553
	NDMP cloning	554
	Cloning between storage nodes	554
	Cloning functionality	554
	NDMP index and bootstrap cloning	554
	NDMP Path-to-Tape cloning for regular save sets	555
	Ancillary product information	557
	Filers that act as data servers	557
	Network Appliance	558
	SnapImage software	569
	Filers that act as tape servers only	569
Chapter 21	SNMP Module	
	SNMP traps	574
	Configuring NetWorker SNMP notifications	574
	Command line options for nsrtrap	574
	Modifying preconfigured NetWorker SNMP notification	575
	Creating NetWorker SNMP notifications	575
	Configuring SNMP management software	576
	NetWorker SMI Network Management Private Enterprise Code	576
	Receiving traps in the SNMP network management software	576
Chapter 22	DiskXtender Data Manager File System Support	
	Supported configurations	578
	Path information	578
	Permissions	578
	DiskXtender Data Manager file system overview	578
	File data in a DXDM file system	578
	Backup of DXDM file systems	580
	Aborted backups	581
	Recovery of DXDM file systems	582
	Initiating a recovery	582
	Restoring deleted files and previous file versions	583
	File system synchronization	583
	Automatic synchronization	584
	Manually synchronizing a file	584
Chapter 23	Support for Windows XP and 2003 Automated System Recovery	
	Microsoft Automated System Recovery	586
	Microsoft ASR documentation	586
	NetWorker support for ASR	586
	NetWorker ASR save set	586
	Usage overview	587
	Network connection names	587

- ASR Limitations and special considerations 587
 - FAT16 partitions are not supported 588
 - OEM recovery CDs are not supported 588
 - Vendor-specific drivers must be installed after Windows installation... 588
- ASR backup 588
 - How to include the ASR or VSS ASR DISK save set in a scheduled backup 589
 - How to include ASR or VSS ASR DISK save set in a manual backup 589
- Creating an ASR disk..... 590
 - Prerequisites..... 590
 - Create an ASR disk locally..... 590
 - Creating an ASR disk by using directed recovery 591
 - Posting ASR disk creation task 592
- Using the ASR disk to recover a NetWorker client 592
 - Requirements for an ASR recovery 592
 - Performing an ASR recovery..... 593
 - Performing a manual ASR recovery on Windows 2003 x64..... 594
 - Components that require special handling after an ASR recovery 594
 - Verifying the NetWorker client recovery 595

Chapter 24 Support for Windows 2008 / 2008 R2 / Windows 7 Disaster Recovery

- Terminology 598
- Windows Disaster Recovery overview 599
 - Offline versus online recovery 600
 - Backup and recovery roadmap..... 601
 - Changes to the All backup save set..... 602
- Windows Disaster Recovery limitations and considerations 606
 - Regular backups..... 606
 - Capturing disk configuration changes for Windows Disaster Recovery 606
 - Full backups are required for Windows Disaster Recovery 606
 - Use deduplication if possible 607
 - Windows Disaster Recovery is not available for online recovery 607
 - Mixing critical and non-critical volumes on a physical disk 607
 - Cloning disaster recovery save sets..... 607
 - Support for NetWorker directives..... 608
 - EFI and uEFI systems are not supported..... 608
 - Only NTFS file systems are recognized as critical volumes 608
 - Fat / Fat32 file systems are not recognized as critical volumes..... 608
 - VSS save sets and post-offline recovery tasks 608
 - Protecting Windows Server Roles 609
 - Protecting Microsoft server applications 610
 - SQL cluster with NMSQL as backup software 610
 - VMware considerations 612
 - Conflict with drive letter X: 612
- Windows Disaster Recovery backups 613
 - Back up planning 613
 - How to include Windows DR in scheduled backups..... 614
 - How to include Windows Disaster Recovery in manual backups 616
 - How to verify that a valid disaster recovery backup exists..... 616
- Windows Disaster Recovery operations 618
 - Task 1: Create the NetWorker Windows Disaster Recovery bootable media 618
 - Task 2: Prerequisites 620
 - Task 3: Gather information..... 620

Task 4: Test the wizard	621
Task 5: Run the wizard	621
Task 6: Post-Restore operations.....	632
Troubleshooting Windows Disaster Recovery.....	636
Additional recover options	640
Optimizing Disaster Recovery backups	641
Critical volume management recommendations.....	641
Save Operations attributes for Windows Disaster Recovery	641
Putting disaster recovery backups on a different schedule	642
Chapter 25	Volume Shadow Copy Service
Overview of VSS	646
VSS and the backup process.....	646
Provider support.....	648
The importance of writers	648
Controlling VSS from NetWorker software	648
Controlling VSS from the Administration window	649
Controlling VSS from the NetWorker client.....	650
Control VSS from the command-prompt.....	651
Globally disabling VSS	651
VSS commands	652
Handling MSDE, SQL Server, and Microsoft Exchange databases	653
Authoritative restores of the Active Directory Application Mode (ADAM) writers	653
Chapter 26	Support for HomeBase
Introduction to HomeBase support (NetWorker Enhanced Server Recovery) 656	
Windows Disaster Recovery vs. NetWorker Enhanced Server Recovery 656	
NetWorker BMR HomeBase Server.....	656
Installation considerations	656
NetWorker Enhanced Server Recovery backups	657
Requirements for Windows Enhanced Server Recovery.....	657
Configuring a client for BMR support.....	657
Recovering with BMR	658
Excluding files for Homebase BMR recovery.....	660
Chapter 27	Troubleshooting
Before contacting technical support.....	662
Determining the version of NetWorker software running on a client ...	662
Displaying diagnostic mode attributes	663
Viewing log files.....	663
Rendering log files in the current locale at runtime	663
How to view log files with the nsr_render_log program	664
Viewing log files from remote host machines	665
Log files from previous releases of NetWorker	665
Filtering log file information displayed by nsr_render_log.....	665
Locating savegroup job logs	666
NetWorker functionality issues	667
Backup and recovery.....	667
Backups fail to start when daylight savings time change occurs	668
Clone ID timestamp does not reflect the time the cone was created	668
Backups fail to stop	668
Memory usage when browsing large save sets.....	669

Memory usage and nsrjobd	669
Media position errors encountered when auto media verify is enabled	669
PACKET RECEIVE BUFFER and NO ECB counters increase.....	669
The scanner program marks a volume read-only	670
The scanner program requests an entry for record size.....	670
Limitations for groups containing a bootstrap	670
Index recovery to a different location fails.....	670
Illegal characters in configurations	670
Error backing up large number of clients.....	671
Hostname aliases.....	671
Directory pathname restrictions	672
Failed recover operation directly after new installation	672
Recovering files from an interrupted backup	672
Backup of a new client defaults to level full	672
Non-full backup of Solaris files with modified extended attributes	672
Renamed clients cannot recover old backups.....	673
Client file index errors.....	673
Cannot use the Console interface to stop the savegrp command.....	674
Aborting a recovery	674
RPC error.....	674
Error message when relocating data	674
Desktop heap size limitation	674
The All save set and duplicate drive serial numbers.....	675
Disk label errors	675
Cannot print bootstrap information.....	676
Server index not forced	676
Copy violation	676
Xview errors.....	676
Converting sparse files to fully allocated files.....	677
Backing up large sparse files	677
The mminfo -N command is case-sensitive regarding save set names... ..	678
Devices and autochangers	679
Additional attributes in the Autochanger resource	679
Maintenance commands	680
Autodetected SCSI jukebox option causes server to stop responding....	680
Autochanger inventory problems	680
Destination component full messages	680
Tapes do not fill to capacity.....	681
Tapes get stuck in drive when labelling on Linux Red Hat platform	681
Increasing the value of Save Mount Time-out for label operations	682
Server cannot access autochanger control port	682
Nonrewinding device requirement.....	683
Scanner command behaves differently with adv_file type device.....	683
Sleep times required for TZ89 drive types	684
Managing optical drives with Solaris 9	684
Message displayed when CDI enabled on NDMP or disk FTD	685
Verifying firmware for switches and routers	685
Commands issued with nsrjb on a multi-NIC host fail.....	685
SCSI reserve/release with dynamic drive sharing	685
Device ordering issues	686
Recovery of save sets from a VTL.....	687
NetWorker locale and code set support.....	687
Issues with fonts when using X servers on Linux.....	687
Resource database notes.....	687
Viewing resources.....	688

Repairing resource database corruption	688
Network and server communication errors.....	688
General issues.....	689
Firewall issues.....	690
UNIX communication issues.....	691
Troubleshoot IP errors	691
Binding to server errors	694
Saving remote file systems.....	694
Microsoft Windows communication issues	696
NetWorker archiving and retrieval	698
Remote archive request from server fails.....	698
Multiple save sets appear as a single archive save set.....	699
Wrong archive pool is selected.....	699
Second archive request does not execute.....	699
The nsrchive program does not start immediately	699
Archive request succeeds but generates error when nsrexecd is not running.....	699
Empty annotations in retrieve list.....	699
Storage nodes	699
Storage node affinity errors	699
Storage node timeout errors.....	700
Storage node communication errors.....	700
Console error messages and corrective actions.....	701
Console log files	703
The install log.....	703
The gstd log	704
Console troubleshooting notes and tips.....	704
Making sure the Console server is running.....	704
Enabling Java script.....	705
NMC user interface exits unexpectedly	707

Appendix A SYSTEM and VSS SYSTEM Save Sets

SYSTEM save sets	710
Components of the SYSTEM STATE save set	710
Components of the SYSTEM FILES save set	711
Components of the SYSTEM DB save set	712
Components of the SHAREPOINT save set	713
Components of the ASR save set.....	713
VSS SYSTEM save sets	714
Components of the VSS SYSTEM BOOT save set.....	714
Components of the VSS SYSTEM FILESET save set	714
Components of the VSS SYSTEM SERVICES save set.....	715
Components of the VSS USER DATA save set	716
Components of the VSS OTHER save set	716
Components of the VSS ASR DISK save set.....	716

Appendix B Firewall Support

Overview.....	718
Configuring the port ranges in NetWorker software	718
Connection ports range	718
Service ports range	718
Using the nsrports command to update port ranges	719
Using the Console to update the port ranges.....	719

Using nsradmin to update the port ranges 720

Ports needed in the service ports range for NetWorker 7.3.x and later 720

 The NetWorker server 721

 NetWorker storage node..... 721

 NetWorker client..... 722

 NetWorker Management Console..... 722

Ports needed in the service ports range for NetWorker 7.2.x. 723

 NetWorker server..... 723

 NetWorker storage node..... 723

 NetWorker client..... 724

Ports used by NetWorker add-on products..... 724

 AlphaStor 724

 Client Backup Configuration Wizard 724

 NDMP 725

 NetWorker modules 725

Example of a firewall configuration 725

 Multiple firewalls 726

 Additional ports that may be required 726

Access control to local host resources 726

Firewall port enhancement 727

Appendix C Backing Up and Restoring a Microsoft DFS

Overview of a Microsoft Distributed File System (DFS) 730

 Domain-based DFS versus registry-based DFS 730

 DFS junctions 730

DFS-R granular recovery on Windows 2008 and 2008 R2..... 730

DFS backups and restores for Windows 2003 731

 DFS topology information 731

 DFS backup consideration with VSS..... 731

 Configuring a scheduled DFS backup 731

 Restoring a DFS 732

 Authoritative restores of DFS Replication writers 733

Appendix D Additional Features of the Microsoft Windows Server

NetWorker Module for Microsoft Applications 736

Active Directory 736

 Backing up Active Directory 736

 Recovering Active Directory 736

Encrypting file system 736

Event logs 738

Internet information server..... 738

Windows registry 739

 Backward compatibility with earlier NetWorker releases..... 739

Sparse files..... 739

Windows Change Journal 739

 NetWorker support for Change Journal..... 739

 Configuring NetWorker software to use the Change Journal..... 741

Advanced Configuration and Power Interface..... 742

 NetWorker support for ACPI..... 742

Windows print queues 743

Appendix E UNIX and Linux Platform-Specific Notes

Solaris..... 746

Support for Solaris zones.....	746
NetWorker executables not found for Solaris client	746
How to obtain support for devices not supported by Solaris.....	746
Extended file attribute data included in Save Set File Size attribute	746
The inquire command and Solaris 10	747
Linux.....	748
Backup considerations for Linux raw disk partitions	748
Configure Linux operating system to detect SCSI devices	748
Configuration requirements for the inquire command	748
Linux Journaled file system support	748
HP-UX.....	749
Autochanger installation on an HP-UX system	749
How to test the device driver and device file installation.....	750
The “Hardware address not found” message.....	751
Errors from unsupported media in HP tape drives	752
Unloading tape drives on an HP-UX server or storage node	752
SCSI pass-through driver required for HP-UX autochangers	752
Symbolic link entries in the fstab file.....	752
Font warnings when exporting display to a Solaris computer.....	752
Customized backup scripts.....	753
AIX.....	754
STK-9840 drives attached to AIX.....	754
LUS driver operation on AIX.....	754
HP Tru64 UNIX.....	754
Restoring context-dependent symbolic links	754
IRIX.....	756
IRIX displays a “no space left in tape” message	756

Appendix F MAC OS X Support

Support for Mac OS X.....	758
Mac OS X metadata support.....	758
Supported file systems.....	758
Mac OS X backup considerations.....	758
Scheduling a NetWorker client backup on Mac OS X.....	758
Performing a manual backup on Mac OS X	760
Recovering files and directories on Mac OS X using the command prompt.....	760
Task 1: Browse backed-up Mac OS X data.....	760
Task 2: Recover individual files or directories.....	760
Recovering files and directories on Mac OS X using NetWorker Recover... ..	762
Starting NetWorker Recover for the first time	762
Navigating the NetWorker Recover window	763
Configuring NetWorker Recover	765

Appendix G Direct SCSI Backup and Recover

Introduction to direct SCSI backup and recover	770
System requirements.....	770
Unsupported features	770
Performing direct SCSI backup	771
Backing up data on a Symmetrix BCV device.....	771
Backing up data on a raw device	772
Backing up data from the command line.....	773
Performing direct SCSI recover	773
Recovering data to a Symmetrix BCV device.....	774
Recovering data to a raw device	776

	Licensing.....	776
Appendix H	Security Configuration Settings	
	Access control settings.....	778
	User authentication.....	778
	User authorization	778
	Component access control	779
	Log settings	780
	Log files and their descriptions.....	780
	Log management and retrieval.....	780
	Communication security settings	781
	Port usage.....	781
	Encrypting backup data	782
	Encryption for cloud backup data.....	782
	Glossary.....	783
	Index.....	797

As part of an effort to improve and enhance the performance and capabilities of its product lines, EMC periodically releases revisions of its software. Therefore, some functions described in this document may not be supported by all versions of the software or hardware currently in use. For the most up-to-date information on product features, refer to your product release notes.

If a product does not function properly or does not function as described in this document, please contact your EMC representative.

Audience

This guide is part of the NetWorker documentation set, and is intended for use by system administrators who are responsible for setting up and maintaining backups on a network. Operators who monitor daily backups will also find this guide useful.

NetWorker product documentation

This section describes the additional documentation and information products that are available with NetWorker.

NetWorker 7.6 Service Pack 2 Administration Guide

Describes how to configure and maintain the NetWorker software.

NetWorker Release 7.6 Service Pack 2 Installation Guide

Provides instructions for installing or updating the NetWorker software for clients, console, and server on all supported platforms.

NetWorker Release 7.6 Service Pack 2 Cluster Installation Guide

Contains information related to installation of the NetWorker software on cluster server and clients.

NetWorker Release 7.6 Service Pack 2 Release Notes

Contain information on new features and changes, fixed problems, known limitations, environment and system requirements for the latest NetWorker software release.

NetWorker Data Domain Deduplication Devices Integration Guide

Provides planning and configuration information on the use of Data Domain devices for data deduplication backup and storage in a NetWorker environment.

NetWorker VMware Integration Guide

Provides planning and configuration information on the use of VMware in a NetWorker environment.

NetWorker Avamar Integration Guide

Provides planning and configuration information on the use of Avamar in a NetWorker environment.

NetWorker Licensing Guide

Provides information about licensing NetWorker products and features.

NetWorker License Manager 9th Edition Installation and Administration Guide

Provides installation, setup, and configuration information for the NetWorker License Manager product.

NetWorker 7.6 Service Pack 2 Disaster Recovery Guide

Provides information about preparing for and recovering from a disaster related to the loss or damage of a NetWorker server, storage node, client, or NMC server.

NetWorker 7.6 Service Pack 2 Error Message Guide

Provides information on common NetWorker error messages.

NetWorker 7.6 Service Pack 2 Performance Optimization Planning Guide

Contains basic performance tuning information for NetWorker.

NetWorker 7.6 Service Pack 2 Command Reference Guide

Provides reference information for NetWorker commands and options.

NetWorker Management Console Online Help

Describes the day-to-day administration tasks performed in the NetWorker Management Console and the NetWorker Administration window. To view Help, click Help in the main menu.

NetWorker User Online Help

The NetWorker User program is the Windows client interface. The NetWorker User Online Help describes how to use the NetWorker User program, which is the Windows client interface connect to a NetWorker server to back up, recover, archive, and retrieve files over a network.

NetWorker related documentation

The following documents provide more information about the NetWorker software:

EMC Information Protection Software Compatibility Guide

A list of supported client, server, and storage node operating systems for the following software products: AlphaStor, ArchiveXtender, DiskXtender for UNIX/Linux, DiskXtender for Windows, Backup Advisor, AutoStart, AutoStart SE, RepliStor, NetWorker, and NetWorker Modules and Options.

NetWorker Procedure Generator

The NetWorker Procedure Generator (NPG) is a stand-alone Windows application used to generate precise user driven steps for high demand tasks carried out by customers, support, and the field. With the NPG, each procedure is tailored and generated based on user-selectable prompts. This generated procedure gathers the most critical parts of NetWorker product guides and combines experts' advice into a single document with a standardized format.

Note: To access the NetWorker Procedure Generator, log on to <http://www.Powerlink.emc.com>. You must have a service agreement to use this site.

Technical Notes and White Papers

Provides an in-depth technical perspective of a product or products as applied to critical business issues or requirements. Technical Notes and White paper types include technology and business considerations, applied technologies, detailed reviews, and best practices planning.

Conventions used in this document

“UNIX” is used in this guide to denote all supported UNIX and Linux operating systems.

EMC uses the following conventions for special notices.

Note: A note presents information that is important, but not hazard-related.

IMPORTANT

An important notice contains information essential to operation of the software.

Typographical conventions

EMC uses the following type style conventions in this document:

Normal	Used in running (nonprocedural) text for: <ul style="list-style-type: none"> Names of interface elements (such as names of windows, dialog boxes, buttons, fields, and menus) Names of resources, attributes, pools, Boolean expressions, buttons, DQL statements, keywords, clauses, environment variables, filenames, functions, utilities URLs, pathnames, filenames, directory names, computer names, links, groups, service keys, file systems, notifications
Bold:	Used in running (nonprocedural) text for: <ul style="list-style-type: none"> Names of commands, daemons, options, programs, processes, services, applications, utilities, kernels, notifications, system call, man pages Used in procedures for: <ul style="list-style-type: none"> Names of interface elements (such as names of windows, dialog boxes, buttons, fields, and menus) What user specifically selects, clicks, presses, or types
<i>Italic:</i>	Used in all text (including procedures) for: <ul style="list-style-type: none"> Full titles of publications referenced in text Emphasis (for example a new term) Variables
<code>Courier:</code>	Used for: <ul style="list-style-type: none"> System output, such as an error message or script URLs, complete paths, filenames, prompts, and syntax when shown outside of running text.
Courier bold:	Used for: <ul style="list-style-type: none"> Specific user input (such as commands)
<i>Courier italic:</i>	Used in procedures for: <ul style="list-style-type: none"> Variables on command line User input variables
< >	Angle brackets enclose parameter or variable values supplied by the user
[]	Square brackets enclose optional values

	Vertical bar indicates alternate selections - the bar means “or”
{ }	Braces indicate content that you must specify (that is, x or y or z)
...	Ellipses indicate nonessential information omitted from the example

Where to get help

EMC support, product, and licensing information can be obtained as follows.

Product information — For documentation, release notes, software updates, or for information about EMC products, licensing, and service, go to the EMC Online Support website (registration required) at:

<http://Powerlink.EMC.com>

Technical support — For technical support, go to EMC Customer Service on Powerlink. To open a service request through Powerlink, you must have a valid support agreement. Please contact your EMC sales representative for details about obtaining a valid support agreement or to answer any questions about your account.

Your comments

Your suggestions will help us continue to improve the accuracy, organization, and overall quality of the user publications. Please send your opinion of this document to:

BSGdocumentation@emc.com

If you have issues, comments, or questions about specific information or procedures, please include the title and, if available, the part number, the revision (for example, A01), the page numbers, and any other details that will help us locate the subject you are addressing.

This chapter covers these topics:

◆ The EMC NetWorker environment.....	30
◆ NetWorker features	32
◆ IPv4 to IPv6 transition	34
◆ Common NetWorker tasks.....	34
◆ NetWorker user interfaces	36
◆ NetWorker services	48

The EMC NetWorker environment

The EMC® NetWorker® environment provides the ability to protect an enterprise against data loss. As the enterprise grows, so does the complexity and importance of protecting data. NetWorker software provides the power and flexibility to meet these challenges.

The NetWorker software is a cross-platform, client-server application that provides the ability to remotely manage all NetWorker clients and servers from a web-enabled, graphical interface.

NetWorker components

[Figure 1 on page 32](#) illustrates the main components in a NetWorker environment.

Console server

All NetWorker servers and clients are managed from the NetWorker Console server. The Console server also provides reporting and monitoring capabilities for all NetWorker servers and clients.

Console user interface

The Console server is accessed through a graphical interface that can be run from any computer that has a supported web browser and Java Runtime Environment (JRE). The NetWorker Installation Guide provides information on supported web browsers and versions of the JRE. Multiple users can access the Console server concurrently from different browser sessions. A computer that hosts the web browser can also be a NetWorker client.

NetWorker server

NetWorker servers provide services to back up and recover data for the NetWorker client computers in a datazone.

Datazone

A datazone is a single NetWorker server and its client computers. Datazones can be added as backup requirements increase.

NetWorker storage node

A NetWorker storage node can be used to improve performance by offloading from the NetWorker server much of the data movement involved in a backup or recovery operation.

NetWorker client

A NetWorker client computer is any computer whose data must be backed up. The NetWorker Console server, NetWorker servers, and NetWorker storage nodes are also NetWorker clients.

Deduplication nodes

NetWorker supports EMC Avamar® and Data Domain deduplication. The *NetWorker Avamar Integration Guide*, provides detailed information about setting up Avamar deduplication to work with NetWorker. The *NetWorker Data Domain Deduplication Devices Integration Guide* provides detailed information about setting up Data Domain deduplication to work with NetWorker.

Virtual environments

NetWorker clients can be created for virtual machines for either traditional backup or VMware Consolidated Backup (VCB). Additionally, the NetWorker software can automatically discover virtual environments and changes to those environments on either a scheduled or on-demand basis and provides a graphical view of those environments.

NetWorker bare metal recovery (BMR) HomeBase Server

A NetWorker BMR server is an EMC HomeBase Server that manages and restores operating system and server state data, collected as profiles. The HomeBase Server is the collection point for profiles produced by HomeBase Agents. HomeBase Agents are automatically installed with the NetWorker client software. The profile data includes:

- ◆ hardware configurations
- ◆ operating system levels
- ◆ system tuning
- ◆ network connections
- ◆ security
- ◆ storage layouts.

The HomeBase Agent captures this information on a scheduled basis with a NetWorker save set, and sends the profile results to a HomeBase Server for management and analysis.

A BMR recovery enables the restoration or migration of a server from one hardware type to another. This type of recovery begins with the HomeBase Server and the profile data that is gathered and includes the file system and application data restore from the NetWorker server through the Console server.

HomeBase Server installation is separate from NetWorker server installation. The HomeBase Server must be configured and available when:

- ◆ A BMR client resource is created.
- ◆ BMR backup data (profiles) are generated from NetWorker clients.

[Chapter 26, “Support for HomeBase”](#) provides detailed information on BMR. The EMC HomeBase product documentation provides details about HomeBase Server installation, profile management, and recovery specifics.

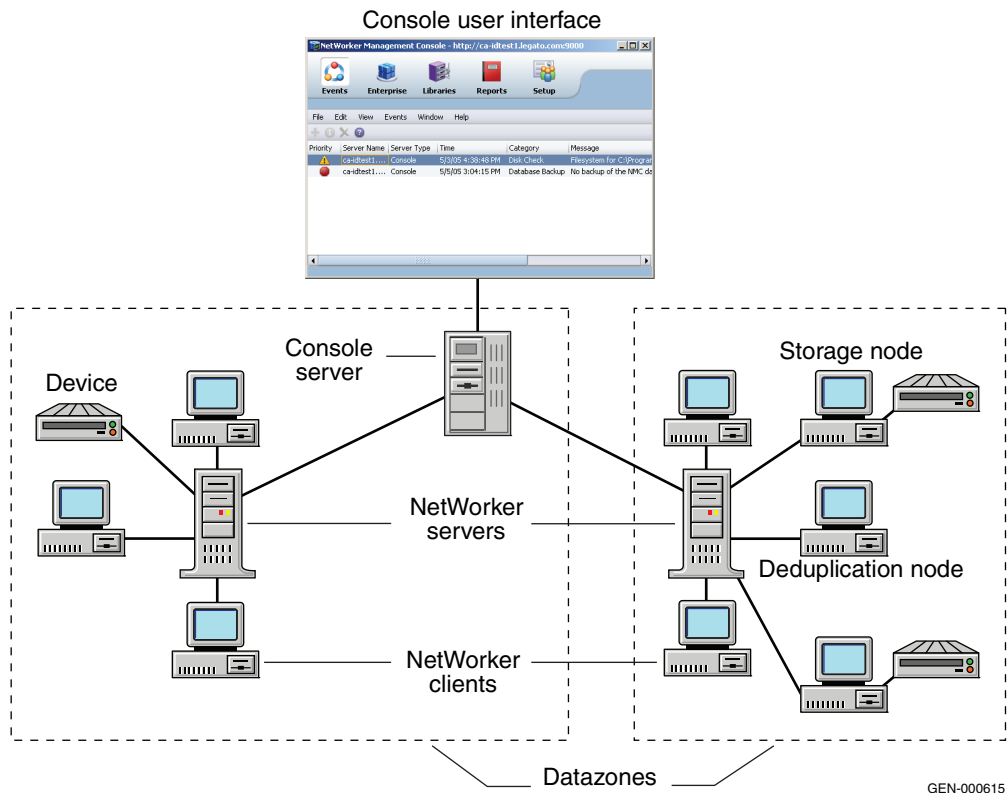

Figure 1 NetWorker components

NetWorker features

This section describes the major features that distinguish the NetWorker software. Optional additions to the NetWorker software are also listed.

Performance features

Standard NetWorker performance features include:

- ◆ Server parallelism, which enables several *save streams* to flow to the server or storage node at the same time.
- ◆ Multiplexing, which enables more than one save stream to write to the same device at the same time.
- ◆ Client parallelism, which enables the client to send more than one save stream at a time.
- ◆ Session management, which enables one to control the number of save streams per device to maximize the performance of each device.
- ◆ Backup to file-based devices and optional subsequent staging and cloning to near-line or offline volumes.
- ◆ Backup to a cloud storage configuration.

Ease of use

NetWorker software provides tools to make protection of critical data easy to manage. With these tools, you can:

- ◆ Use either the graphical interfaces or command-line programs to manage NetWorker tasks and functions.
- ◆ Use wizards to set up the following NetWorker items:
 - Client resources
 - AFTD and Data Domain devices
 - Common Console configuration tasks
 - LDAP user authentication
- ◆ Administer and configure NetWorker functions from any network computer with a web browser.
- ◆ Grant permission to provide directed recovery operations. Directed recovery is the capability for recovery of one client's data to another client computer.
- ◆ Obtain immediate answers to questions by accessing online help and UNIX man pages. Microsoft Windows users can also access the NetWorker command reference guide, which provides information similar to the UNIX man pages.
- ◆ Take advantage of the automatic media management feature to enable the NetWorker server or storage node to label and mount volumes as needed for backups.
- ◆ Drag-and-drop functionality allows for an easy transfer of single or multiple objects.
- ◆ Use the integrated knowledge base and technical bulletins at the EMC Powerlink® website to find answers to common questions.
- ◆ Automatically discover and view a graphical map of virtual environments.
- ◆ Set up NetWorker Console server authentication to an external LDAP v3.1 compliant server.
- ◆ Support for automated Windows Disaster Recovery.

Scalability

NetWorker software can be scaled as storage management needs grow. For example, you can:

- ◆ Upgrade the basic level of server functionality, add support for additional (or larger) autochangers, add support for more clients, or add optional software modules without the need to reinstall the server software.
- ◆ Add special NetWorker Module client software to back up databases and other non-file-system data.
- ◆ Add support for remote storage nodes to control backup devices, while the data management tasks remain centralized on a controlling NetWorker server.
- ◆ Add the NetWorker License Manager (NLM) software to administer all of your network's EMC software licenses from a single server.

Optional software additions

Optional additions to the NetWorker software include:

- ◆ NetWorker Autochanger Module
- ◆ NetWorker Silo Software Module
- ◆ NetWorker Archive Module
- ◆ NetWorker Database Modules (for backing up several types of databases)
- ◆ NetWorker SNMP (Simple Network Management Protocol)
- ◆ NDMP (Network Data Management Protocol) support
- ◆ EMC DiskXtender® Data Manager File System Support
- ◆ Support for OpenVault remote storage systems (Windows only)
- ◆ Cluster support, including EMC AutoStart™ software
- ◆ NetWorker License Manager
- ◆ Advanced reporting capability

IPv4 to IPv6 transition

Internet Protocol version 6 or IPv6 is designed to replace the current Internet Protocol which is IPv4. IPv6 fixes a number of problems in IPv4, such as the limited number of available IPv4 addresses. It also adds many improvements to IPv4 in areas such as routing and network autoconfiguration. IPv6 is expected to gradually replace IPv4, with the two coexisting for a number of years during a transition period. The *NetWorker Installation Guide* provides information about using NetWorker in an IPv6 environment.

Common NetWorker tasks

This section identifies some of the most common tasks performed with the NetWorker Console. These include:

- ◆ [“How to add a new host” on page 34](#)
- ◆ [“How to schedule a backup” on page 35](#)
- ◆ [“How to configure devices” on page 35](#)
- ◆ [“How to label media” on page 35](#)
- ◆ [“How to view failed backups” on page 36](#)

[“NetWorker Management Console interface” on page 36](#) has information about starting the NetWorker Console.

How to add a new host



To add a new host in the NetWorker Console:

1. Log in to Console as a NetWorker Administrator.
2. Click the **Enterprise** button  on the taskbar.
3. Right-click **Enterprise** in the navigation tree.

4. Select **New > Host**.
5. In the **Create Host** dialog box, type in the new host name and click **Next**. The **Select Managed Application** dialog box appears.
6. Click **Next**. The **Manage NetWorker** dialog box appears.
7. Make sure the following checkboxes are enabled:
 - For NetWorker: **Capture Events** and **Gather Reporting Data**
 - For Avamar: **Capture Events**
8. Click **Finish**.

How to schedule a backup



To schedule backups from the NetWorker Console:

1. Log in to the Console as a NetWorker Administrator.
2. Click the **Enterprise** button  on the taskbar.
3. Highlight a host in the navigation tree, right-click **NetWorker** and select **Launch Application**. The **NetWorker Administration** window appears.
4. Click the **Configuration** button  on the taskbar.
5. Define schedules, groups, and clients.

[“Planning a scheduled backup” on page 54](#) provides information about scheduling backups.

How to configure devices



To configure devices from the NetWorker Console:

1. Log in to the Console as a NetWorker Administrator.
2. Click the **Enterprise** button  on the taskbar.
3. Highlight a host in the navigation tree, right-click **NetWorker** and select **Launch Application**. The **NetWorker Administration** window appears.
4. Click the **Configuration** button  on the taskbar.
5. Click the **Devices** button  on the taskbar.
6. In the navigation tree view, right-click a host and select **Scan for Devices**.

[Chapter 3, “Configuring Libraries and Devices”](#) information about configuring media.

How to label media

To label tapes from the NetWorker Console:



1. Log in to the Console as a NetWorker Administrator.
2. Click the **Enterprise** button  on the taskbar.
3. Highlight a host in the navigation tree, right-click **NetWorker** and select **Launch Application**. The **NetWorker Administration** window appears.
4. Click the **Configuration** button  on the taskbar.

5. Click the **Devices** button  on the taskbar.
6. In the navigation tree view, expand **Libraries** and highlight a library, or select **Devices**.
7. In the **Device list**, right-click a device and select **Label**.

[Chapter 12, “Media Management”](#) provides information about labeling tapes.

How to view failed backups

To see whether any backups have failed:

1. Log in to the Console as a NetWorker Administrator.
2. Click the **Enterprise** button  on the taskbar.
3. Highlight a host in the navigation tree, right-click **NetWorker** and select **Launch Application**. The **NetWorker Administration** window appears.
4. Click the **Configuration** button  on the taskbar.
5. Click **Monitoring** .
6. Select **Groups** in the docking panel.

[Chapter 15, “Events and Monitoring”](#) provides information about viewing backup status information

NetWorker user interfaces

The NetWorker application consists of these user interfaces:

- ◆ [“NetWorker Management Console interface” on page 36](#)
- ◆ [“NetWorker client interface” on page 43](#)
- ◆ [“NetWorker character-based interface” on page 48](#)
- ◆ [“NetWorker command-line interface” on page 48](#)

NetWorker Management Console interface

The interface for NetWorker Management Console, also called the NetWorker Console, consists of two main windows:

- ◆ Console window
- ◆ Administration window

Console window

When NetWorker software is started, the Console window appears as shown in [Figure 2](#).

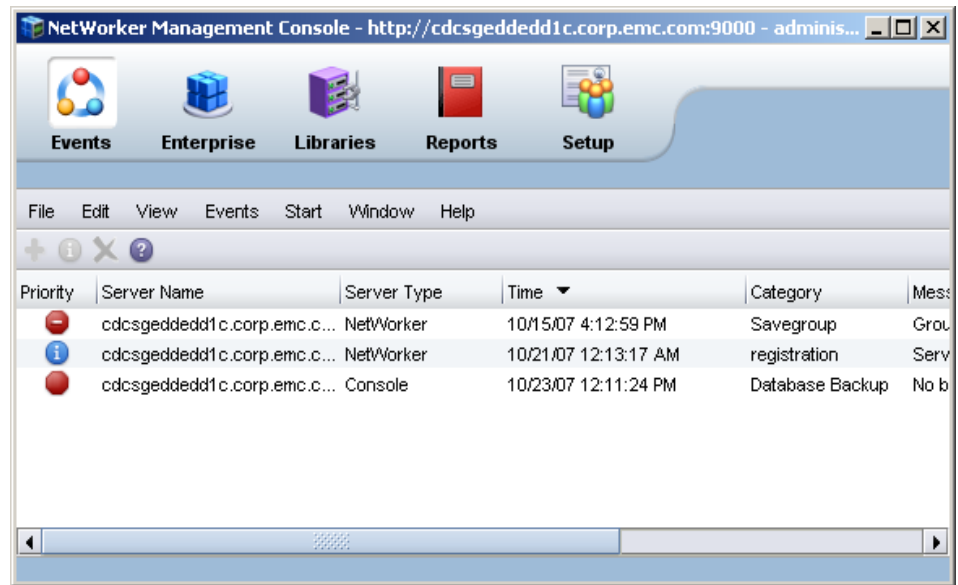







Figure 2 Console window

The Console window is the first point of access for NetWorker tasks. [Table 1 on page 37](#) lists the task-based windows that can be opened from the Console window taskbar.

Table 1 Windows opened from the Console window

Button	Window	Description
	Events	View important messages about all NetWorker servers that have been added as Enterprise applications, as well as the Console server, and Avamar server. “Events” on page 388 provides information about managed events.
	Enterprise	Select a NetWorker server to manage and monitor the server and its backup clients. The Enterprise window allows you to open the Administration window for a NetWorker server.
	Libraries	View summary information and manage libraries for all NetWorker servers. The Administration window can also be opened from this location.
	Reports	Configure and view Console reports. Chapter 14, “Reporting.” provides information about reports.
	Setup	Control administrative functions: <ul style="list-style-type: none"> User management — Add, edit, and delete Console user accounts, restrict user views of servers. “Managing NetWorker Console server users” on page 406 provides information about user management. License management — Manage NetWorker licenses. The new for 7.6 Service Pack 1 NetWorker <i>Licensing Guide</i> provides information about license management.

Administration window

NetWorker servers are managed through the Administration window as shown in Figure 3.

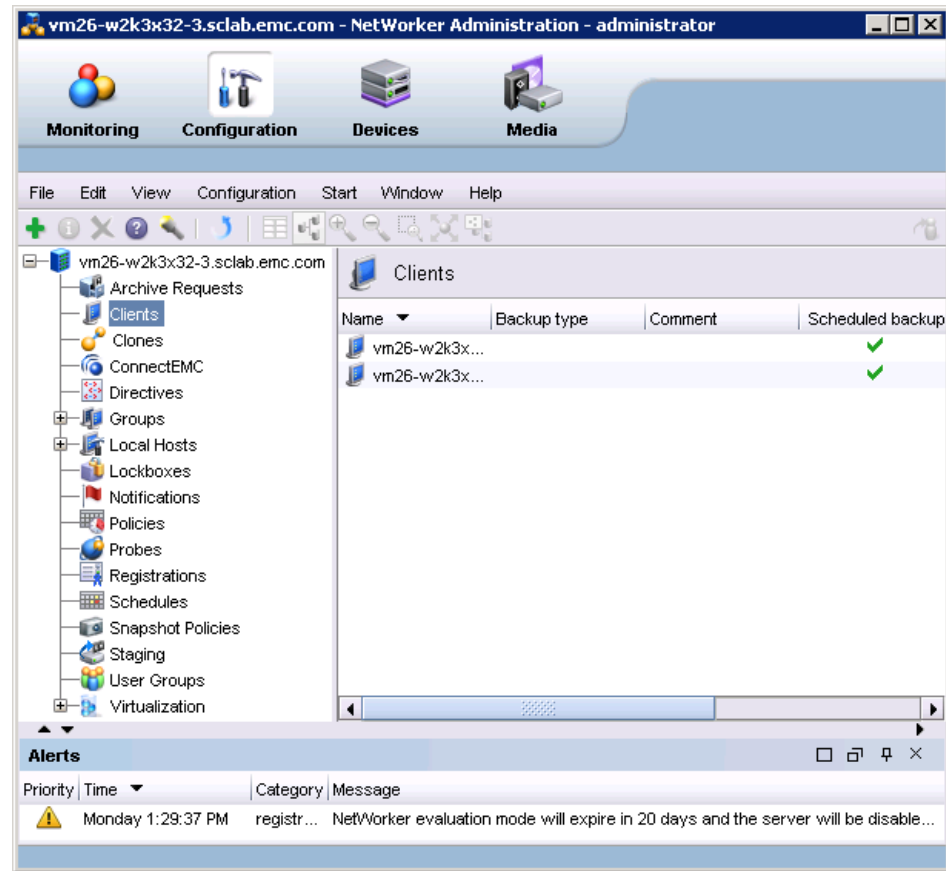

Figure 3 Administration window

You can toggle between the **Administration** window and the Console window.

Table 2 on page 38 lists the windows that can be launched from the **Administration** window taskbar.

Table 2 Windows launched from the Administration window(1 of 2)





Button	Window	Description
	Monitoring	Monitor various activities related to the NetWorker server. For example, you can monitor the progress of a scheduled backup and view any alerts. A portion of the Monitoring window appears at the bottom of the Administration window at all times, providing monitoring information on Log Messages and Alerts.

Table 2 Windows launched from the Administration window(2 of 2)

Button	Window	Description
	Configuration	Manage the NetWorker server and its resources such as clients, backup schedules, and policies. For example, you can create a backup schedule, add NetWorker clients, and apply the backup schedule to several NetWorker clients.
	Devices	Add, configure, and operate single or multiple devices, libraries, and silos for the NetWorker server.
	Media	Manage activities and resources related to backup volumes. For example, you can mount a backup volume or create a template for labeling backup volumes.

Starting Console for the first time

These steps assume that the NetWorker software is installed and that all of the software and hardware requirements have been met on the computer that will access Console. The *NetWorker Installation Guide* provides more information.

To open Console for the first time:

1. Start a web browser session.
2. Type the following command to specify the Console server URL:

```
http://server_name:http_service_port
```

where:

- *server_name* is the name of the computer where the Console server component is installed.
 - *http_service_port* is the IP port for the embedded HTTP server. The HTTP port is specified during installation. The default HTTP port is 9000.
3. From the **Welcome** page, click **Start NetWorker Management Console**.
 4. From the **Security Warning** screen, click **Start** to run NetWorker Console.
 - If the JRE was *not* already installed on the system, a prompt to install it appears. Follow the on-screen instructions to install JRE.
 - Once the JRE has been installed, the Java Web Start Desktop Integration dialog box appears.
 5. Complete the **Java Web Start Desktop Integration** banner dialog box by selecting one of these options:
 - To place a shortcut on the desktop, click **Yes**.
 - To decline having a shortcut placed on the desktop, click **No**.
 - To have the option to decide later, click **Ask Later**.
 6. In the **NetWorker Management Console Login** banner dialog box, type the username and password.

Note: The default password for the administrator account is *administrator*. For added security, change the password during the first login session. [“Resetting the administrator password \(native authentication only\)” on page 412](#) provides information if the administrator password needs to be changed.

7. Click **OK** and the **Console** window appears.

Start Console after the first time

After Console has been started the first time, you can restart it by using any of these methods:

- ◆ Point the browser to the same URL. [“Starting Console for the first time” on page 39](#) provides information.
- ◆ Double-click the **NetWorker Console** product name in the **Java Web Start Application Manager**.
- ◆ Double-click the desktop button, if one was set up through the Java Web Start Application Manager.

Opening the Administration Window

To add and select a NetWorker server and open the Administration window:

1. From the Console window, click **Enterprise**.
2. Add one or more NetWorker servers:
 - a. Highlight **Enterprise** in the navigation tree.
 - b. From the **File** menu, select **New>Host**.
 - c. Type the name of the host on which the NetWorker server is running and click **Next**.
 - d. Select **NetWorker** for the type of application to be managed.
 - e. Click **Finish**.
 - f. Repeat for all NetWorker servers in your network.
3. From the left pane, click a host in the **Enterprise** list.
4. From the right pane, click the application and select **Enterprise>Launch Application**, or double-click the application. The **Administration** window is launched as a separate application.

Sorting tables

Console software’s organization and display of tabular information can be changed. Tables can be sorted by column heading, and then by alphabetic or numeric order within those columns.

To rearrange information in a table:

1. Drag-and-drop the column heading to its new position.
2. Click the column heading to sort the items into alphabetic and numeric order. An arrow appears in the column heading to indicate the sort order.

Example 1 Sorting managed events

John wants to see all the managed events about servers that were unreachable by the Console server.

1. From the Console window, John clicks **Events**.
2. He clicks and drags the **Message** column until it is over the **Priority** column, where he drops it.
3. He clicks the **Message** column heading so that a down-arrow appears.

Now he can scan down the list of messages until he finds three servers, all with the message Unable to connect to server.

John could also generate a **Managed Event Details** report to get the same information, which could be printed or exported for use in another application. [Chapter 14, “Reporting”](#) provides more information about reports.

Sorting selected rows in a table

To sort selected rows in a table:

1. From the **Edit** menu, select **Find** or press **Ctrl + F** to view the **Find** panel.
2. Click the rows to be selected or select rows by using the Find criteria.
3. Select **Sort Selected**.

Selected rows will be sorted to the top of the table. This is particularly useful when you select **Highlight All** from the **Find** panel to select all rows matching the Find criteria and then moving all selected rows to the top of the table to view the results.

Sorting multiple columns in a table

To sort by two or more columns in a table:

1. Click the column to be used as the last sort key.
2. Click the column to be used as the next-to-last sort key and so on until the primary column is selected.

For example, given a large table of events, you can select the **Time** column as the tertiary sort key, the **Category** column for the secondary sort key, and the **Server** name as the primary sort key. The resulting display would list the servers in alphabetical order, and the events for each server would be grouped by category and would display in chronological order.

Displaying columns in a table

To select which columns to display in a table:

1. From the **View** menu, select **Choose Table Columns**.
2. Click a column name to select or clear the column and then click **OK**.

Drag-and-drop functionality

Drag-and-drop functionality is available in the Console and Administration interfaces to perform the following tasks:

- ◆ [“Drag-and-drop between resource types in the Console window” on page 41](#)
- ◆ [“Client and group management in the Administration window” on page 42](#)
- ◆ [“Library operations in the Devices window” on page 42](#)
- ◆ [“Copy and paste tabular information to operating system clipboard” on page 43](#)

Drag-and-drop between resource types in the Console window

The drag-and-drop functionality allows multiple resources to be selected and moved from one resource type to another.

In the Enterprise window from the Console interface, you can drag-and-drop to perform the following actions:

- ◆ Copy an individual folder in the enterprise hierarchy by selecting the folder, holding down the Ctrl key, and dragging the folder to a new location.

- ◆ Move an individual folder in the enterprise hierarchy to a new location by selecting and dragging a folder to a new location.
- ◆ Copy an individual host node in the enterprise hierarchy by selecting and dragging the host to a new parent folder.
- ◆ Move an individual host node in the enterprise hierarchy by selecting and dragging the host to a new parent folder.
- ◆ Copy a selected number of objects in a folder to a new folder in the hierarchy tree or folder contents table. Select an individual folder in the navigation tree to display the contents of the folder, select the contents, hold down the Ctrl key, and drag the contents to a new folder. Select a collection of folders and/or hosts and drag them to a new folder by creating a copy of the selected contents in a new location.
- ◆ Move a selected number of objects in a folder to a new folder in the hierarchy tree or folder contents table. Select an individual folder in the navigation tree to display the contents of the folder, select the contents and drag the contents to a new folder. Select a collection of folders and/or hosts and drag them to a new folder by moving the selected contents to a new location.

Note: Only one object may be selected for drag-and-drop in the navigation tree.

Client and group management in the Administration window

The drag-and-drop functionality allows multiple clients or groups to be selected and moved from one location to another. You can use drag-and-drop functionality in the Configuration window to do the following:

- ◆ Copy selected clients to a new NetWorker group. Expand a group in the directory tree and select. Drag-and-drop the client objects in the Client Summary table to a new group in the directory tree.
- ◆ Copy selected clients from one NetWorker group to a new group. Select a group in the directory tree and move clients from the Client Summary table to another NetWorker group.
- ◆ Move selected clients to a new NetWorker group. Expand a group in the directory tree and select one or more clients. Drag-and-drop the client objects in the Client Summary table to a new group in the directory tree. This will remove the client objects from the initial NetWorker group.
- ◆ Change a group's current schedule to a selected schedule. Select a group in the directory tree to display the group objects. Drag-and-drop a schedule in the Schedule Summary table to a different group in the directory tree.

Library operations in the Devices window

The drag-and-drop functionality allows multiple slots or devices to be managed in the Devices window. You can use drag-and-drop functionality to manage media from the Library window from the Devices task, for instance:

- ◆ Mount an individual volume onto a device by selecting a slot in the Slots table and dragging it to a device in the Devices table.
- ◆ Mount multiple volumes to available devices as assigned by the NetWorker server by selecting multiple slots in the Slots table and dragging them anywhere in to the Devices table.
- ◆ Unmount a volume from a selected device and deposit it back in its designated slot. To unmount a volume, select an individual device from the Devices table and drag it anywhere in the Slots table. The volume image will appear in the corresponding slot.

- ◆ Unmount multiple volumes from a selected device and deposit them back in their designated slot. To unmount multiple volumes, select the devices from the Devices table and drag them anywhere in the Slots table. The volumes will appear in the corresponding slots.

Copy and paste tabular information to operating system clipboard

Tabular information can be selected and moved to an operating system clipboard by using drag-and-drop functionality. All tables support selection of multiple rows in a table and the ability to copy and paste the data in the selected rows to the system clipboard. Subsequently, the data in the operating system clipboard can be moved to a target application.

Note: Drag-and-drop operations from the operating system clipboard to a table are not supported.

Multiple library devices and slots

A single operation can be performed on multiple library devices and slots. Multiple rows can be selected in both the Devices and Slots tables simultaneously.

In the Devices table for a library, multiple devices can be selected to perform the following operations:

- ◆ Unmount
- ◆ Release device (STL only)
- ◆ Enable/Disable

In the Slots table for a device, multiple volume operations can be performed for the following operations:

- ◆ Mount
- ◆ Load without mount
- ◆ Withdraw
- ◆ Label
- ◆ Inventory
- ◆ Remove (STL and EMC AlphaStor® only)

Setting user interaction preferences

Depending on the window button that was selected (see [Table 2](#)), you can set various user preferences such as the user interface font, font size, parallel windows, and table settings. For the **Reports** window, there are ways you can enhance the viewing of displayed reports.

To set user preferences:

1. Select **View** on the main menu.
2. Set the various options available under the selected window button. You may need to click **OK**, depending on your option selection.

NetWorker client interface

The client interface is where users can recover data and perform manual backup and archive operations. Manual operations are not scheduled. Instead, they are performed when a user wants to back up or archive one or more files on the

NetWorker client immediately. Scheduled backup and archive operations are set up through the Console interface. For information about the Console interface, see “[NetWorker Management Console interface](#)” on page 36.

Windows client interface

The NetWorker User program shown in [Figure 4](#) is the Windows client interface.

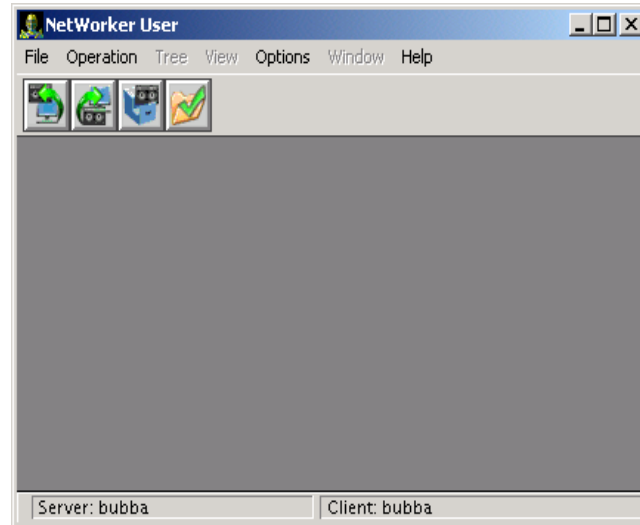

Figure 4 NetWorker User program

Starting the User program on Windows

To start the NetWorker User program, perform one of the following:

- ◆ Click the Windows Start button and select **Programs>EMC NetWorker>NetWorker User**.
- ◆ From the Administration window, click **Start** on the main menu, select “**NetWorker User...**” If the NetWorker Module for Microsoft Applications is installed on the client computer, this operation starts the NetWorker Module for Microsoft Applications instead.

Note: The NetWorker client package must be installed on the host where you start the NetWorker User program. Otherwise, you will see an error message similar to the following:

The user program you are trying to run (winworkr) is either not installed on this computer, or is not in your path.

To start the NetWorker User program, you must belong to the appropriate Windows groups. [Table 3](#) lists the groups that you must belong to in order to run the NetWorker User program.

The Backup Operators and Administrators groups are the local and remote Microsoft security groups.





Table 3 NetWorker User Groups requirements

Logged on	Workstation	Server	Server (domain controller only)
Locally	Backup Operators or Administrators	Backup Operators or Administrators	Not applicable
To the domain	Domain Administrators	Domain Administrators	Backup Operators or Administrators

Toolbar buttons

The NetWorker User program has a toolbar with buttons for common User program tasks. [Table 4](#) describes the function of each button.

Table 4 NetWorker User toolbar functions

Button	Name	Function
	Backup	Starts an manual (unscheduled) backup of the client's data to a NetWorker server.
	Recover	Starts a recovery operation to retrieve copies of saved data back to the client computer.
	Archive	Starts an archive operation to save copies of data to a server for storage on an archive volume. Once the data is stored on the archive volume, you have the option of removing the data from the disk.
	Verify	Starts a verification operation to ensure that the data items just backed up are the same as those currently on the disk.

Browse window

A browse window in the NetWorker User program appears when you select one of the following:

- ◆ A toolbar button
- ◆ A Backup, Recover, Archive, Verify, or Local Directive command from the NetWorker User File menu

The browse window, shown in [Figure 5](#) displays the directory tree of the file system that is being browsed.

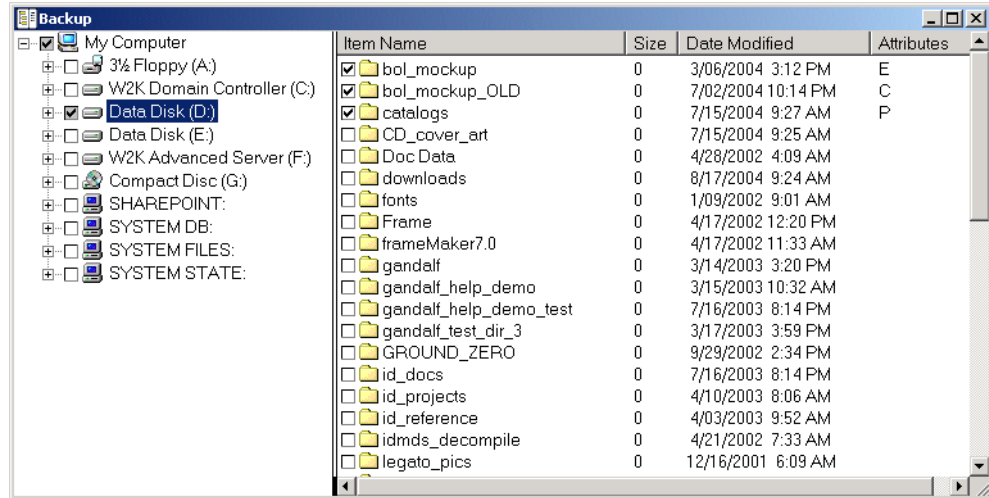

Figure 5 Example of the browse window

Note: When you mark a disk volume or directory for an operation, all of its nested subdirectories and files are also marked.

A checkmark beside an item name indicates that the item is selected for backup, recovery, archiving, or verification.

The Attributes column indicates any special handling option that was applied:

- ◆ **P** — The item is marked for password-protection. [“Encrypting backup data” on page 77](#) provides more information.
- ◆ **E** — The item is marked for password-protection and encryption, using the PW2 ASM. [“Encrypting backup data” on page 77](#) provides more information.
- ◆ **C** — The item is marked for compression. [“Compressing backup data” on page 78](#) provides more information.

Connecting to a NetWorker server

A typical user that runs the NetWorker User program needs to connect to the NetWorker server that performs scheduled backups. However, to perform a directed recovery or to back up files to another server, you might need to connect to a different NetWorker server.

Before the NetWorker User program can connect to a NetWorker server, the client computer must be set up as a Client resource on that NetWorker server. [“Task 6: Create a backup Client resource” on page 59](#) provides information about creating a Client resource.

To connect to a NetWorker server:

1. From the **Operation** menu, select **Change NetWorker Server**.
2. In the **Change Server** dialog box, select a server from the list of available NetWorker servers. If the server is not listed, do one of the following:
 - Click **Update List** to search the network for available NetWorker servers.
 - Type the server’s hostname.

3. Click **OK**.

UNIX client recover interface

The UNIX version of the NetWorker client interface includes a graphical interface program, **nwrecover**, for performing recoveries of backed up data and retrieving archived data.

Command line utilities are used to perform manual backups (the **save** command) and archiving (**nsrchive**). For more information on these commands, refer to the *EMC NetWorker Command Reference Guide* or the UNIX man pages.

The Recover program

Use the recover (**nwrecover**) program to recover backed-up files. You can start the recover program from NetWorker Administration window or from the command line.

To start the recover program from the NetWorker Administration window:

- ◆ From the Administration window, click **Start** on the main menu, select “**NetWorker Recover..**”

Note: The NetWorker client package must be installed on the host where you start the recover program. Otherwise, you will see an error message similar to the following:

The user program you are trying to run (nwrecover) is either not installed on this computer, or is not in your path.

To start the recover program from the command line, type **nwrecover**:

- ◆ To specify the NetWorker server to connect to, type the **-s servername** option:

```
nwrecover -s servername
```

The `/servers` file, located in `/nsr/res/servers`, contains an entry for each available server.

- If the **-s** option is not entered and there is only one server detected, that server will be connected automatically.
 - If there are no servers detected, or if there is more than one server available, the **Change Server** dialog box appears, which allows you to choose the server.
- ◆ To specify the NetWorker client, use the **-c client** option:

```
nwrecover -s servername -c client
```

If the **-c** option is not entered, the local computer is used by default.

Figure 6 displays the **nwrecover** program.

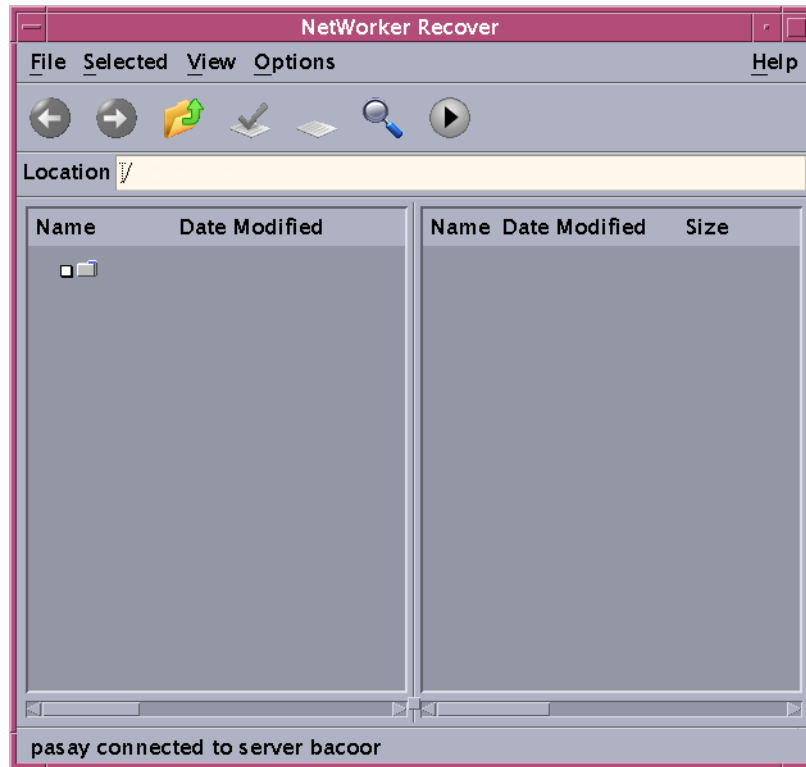

Figure 6 The **nwrecover** Program

NetWorker character-based interface

Use the NetWorker character-based interface (**nsradmin**) to perform configuration and management tasks for a NetWorker server.

To start the **nsradmin** interface, type this command:

```
nsradmin
```

For more information about **nsradmin**, refer to the *EMC NetWorker Command Reference Guide* or the UNIX man pages.

NetWorker command-line interface

Perform client and server tasks by typing commands at the prompt. The *EMC NetWorker Command Reference Guide* or the UNIX man pages provides information about these commands.

NetWorker services

This section provides information about the main services and programs for the NetWorker server and NetWorker Client. It also describes how to start and stop these services. For more information about:

- ◆ Main NetWorker services, The *EMC NetWorker Command Reference Guide* or the UNIX man pages provides more information.

- ◆ Service port requirements when configuring a firewall. [Appendix B, “Firewall Support”](#) provides more information.

Services and programs on the NetWorker server

[Table 5](#) describes the main services and programs that provide NetWorker software functionality.

Table 5 Services or programs on the server

Service or program	Function
nsrexecd	Authenticates and processes the NetWorker server remote execution requests and executes the save and savefs programs on the client.
nsrd	Monitors an active save or recover program session. This is an agent process spawned by nsrd in response to a save or recover session. It (nsrd) is also the master service that controls other services on the NetWorker server, clients, and storage nodes.
nsrmmdbd	Provides media database management services to the local nsrd and nsrmmmd services and records entries in the media database. This is the media management database service.
nsrjobd	Monitors NetWorker activity during a backup or recovery operation.
nsrindexd	Provides a method for inserting entries into the client file index that is based on information passed by the save program.
nsrmmgd	Manages media library operations. It provides an RPC-based service that manages all jukebox operations on behalf of the nsrd service. The nsrd service starts one and only one instance of nsrmmgd on the NetWorker server as needed.

Services and programs on the NetWorker client

The **nsrd** service calls on the NetWorker client service, **nsrexecd**, and several programs on the client when a scheduled or on-demand backup request is received. A temporary server agent, the **ansrd** service, starts on the NetWorker server to monitor the progress of the backup session.

[Table 6](#) describes the main service on the NetWorker client.

Table 6 Services or programs on the client

Service or program	Function
nsrexecd	Authenticates and processes the NetWorker server remote execution requests and executes the save and savefs programs on the client.

Table 7 describes the main services or programs on the NetWorker Storage Node.

Table 7 Services or programs on the NetWorker Storage Node

Service	Function
nsrexecd	Authenticates and processes the NetWorker server remote execution requests and executes the save and savefs programs on the client.
nsrmmd	Provides device support, generates mount requests, and multiplexes save set data during a multiclient backup. It writes the data sent by save to storage media. An additional nsrmmd service is started while mount requests are pending. The nsrd service starts one nsrmmd service for each enabled device. Forwards storage information to nsrmmdbd for recording in the NetWorker server media database.

Table 8 describes the main services or programs on the NetWorker Management Console server.

Table 8 Services or programs on the NetWorker Management Console server

Service or program	Function
nsrexecd	Authenticates and processes the NetWorker server remote execution requests and executes the save and savefs programs on the client.
gstd	Known as the Generic Services Toolkit (GST), controls other services provided by the Console server.
httpd	Starts NMC console on the client through a web browser.
dbsrv9	A database server that manages information pertaining to console management. For example, Console reports.

Stopping and starting the Console server

This section describes how to stop and start the Console server service.

Stop the Console server on Windows

To stop the Console server:

1. Log in as a Windows Administrator and right-click **My Computer** and select **Manage**.
2. Expand **Services and Applications** and select **Services**.
3. Right-click **EMC GST Service (gstd)**, then select **Stop**.

Start the Console server on Windows

To start the Console server:

1. Log in as a Windows Administrator and right-click **My Computer** and select **Manage**.
2. Expand **Services and Applications** and select **Services**.
3. Verify that the NetWorker client is running.

The NetWorker Remote Exec Service (**nsrexecd**) should have a status of **Started**. If the service has not started:

- a. Right-click **NetWorker Remote Exec Service**.
- b. Select **Start**.

4. Right-click **EMC GST Service (gstd)**, then select **Start**.

Stop the Console server on UNIX

To stop the Console server:

1. Log in as root.
2. Type one of the following commands:
 - Solaris and Linux: `/etc/init.d/gst stop`
 - AIX: `/etc/rc.gst stop`
 - HP-UX: `/sbin/init.d/gst stop`

Start the Console server on UNIX

To start the Console server:

1. Log in as root.
2. Verify that the NetWorker client is running.
 - For example, type the following command:

```
/usr/bin/ps -ef | grep nsr
```
 - If the client is running, a message similar to this appears:

```
root240 1 0 ? 0:04 /usr/sbin/nsrexecd -s mysrvr
```
 - If the client is not running, start it. [“Start a NetWorker host on UNIX” on page 52](#) provides information about starting the client.
3. Start the Console server by typing one of the following commands:
 - Solaris and Linux: `/etc/init.d/gst start`
 - AIX: `/etc/rc.gst start`
 - HP-UX: `/sbin/init.d/gst start`

Stopping and starting a NetWorker server, client, or storage node

This section describes how to manually stop and start the services for a NetWorker server, client, or storage node.

Stop a NetWorker host on Windows

To stop a server, client, or storage node:

1. Log in as a Windows Administrator.
2. Right-click **My Computer** and select **Manage**.
3. Expand **Services and Applications** and select **Services**.
4. Right-click **NetWorker Remote Exec Service (nsrexecd)** and select **Stop**.

Start a NetWorker host on Windows

To start a server, client, or storage node:

1. Log in as a Windows Administrator.
2. Right-click **My Computer** and select **Manage**.
3. Expand **Services and Applications** and select **Services**.
4. Start the appropriate service.
 - NetWorker server: Right-click the **NetWorker Backup and Recover Server** service (**nsrd**) and select **Start**.

- NetWorker client or storage node: Right-click the **NetWorker Remote Exec Service (nsrexecd)** and select **Start**.

Stop a NetWorker host on UNIX

To stop the NetWorker services, log in as root and type the following command:

```
nsr_shutdown
```

Start a NetWorker host on UNIX

To start NetWorker services, log in as root and type the appropriate startup command listed in [Table 9](#).

Table 9 NetWorker startup commands

Operating system	Startup command
Solaris, Linux, IRIX	<code>/etc/init.d/networker start</code>
HP-UX	<code>/sbin/init.d/networker start</code>
HP Tru64 UNIX	<code>/sbin/init.d/NSRstartstop start</code>
AIX	<code>/etc/rc.nsr</code>

Stop a NetWorker host on Mac OS X

To stop the NetWorker host:

1. Log in as a Mac Administrator.
2. Open the Mac OS X Terminal application utility.
3. Stop the service by typing the following command:

```
# SystemStarter stop NetWorker
```

Start a NetWorker host on Mac OS X

To start the NetWorker host:

1. Log in as a Mac Administrator.
2. Open the Mac OS X Terminal application utility.
3. Start the client by typing the following command:

```
# SystemStarter start NetWorker
```

This chapter covers these topics:

◆ Scheduled backups	54
◆ Save sets	61
◆ Manual backups	64
◆ Verifying backed-up data	69
◆ Probe-based backups	69
◆ Checkpoint restart backups	69
◆ Deduplication backups	76
◆ BMR backups	77
◆ Encrypting backup data	77
◆ Compressing backup data	78
◆ Special data handling for NetWorker clients on Windows	78
◆ Backing up NetWorker Console Management data	79
◆ Backing up Windows mount points	81
◆ Backing up the Windows Content Index Server	82
◆ Backing up Windows DHCP and WINS databases	83
◆ Windows backup and recovery notes	84
◆ Customizing the backup command	86
◆ Considerations for backing up raw partitions	94
◆ Backing up a mapped drive	95
◆ Backing up access control lists	95
◆ Backing up BOOT/BCD Data on Windows 2008R2 and Windows 7	95
◆ Support for backing up renamed directories	96

Scheduled backups

The NetWorker server backs up client data regularly by using scheduled backups. They are preferred over the [“Manual backups” on page 64](#) because the backups occur automatically, and data can be recovered more easily. You can also start scheduled backups at any time.

This section explains how to plan and create scheduled backups, including:

- ◆ [“Planning a scheduled backup” on page 54](#)
- ◆ [“Setting up a scheduled backup” on page 55](#)

Planning a scheduled backup

This section uses a scenario with the requirements of an accounting department to highlight tasks to consider when planning a scheduled backup.

Example 2 Planning scheduled backups for the accounting computers

Company XYZ wants to ensure that all of the computers in the Accounting department are backed up according to the requirements listed in [Table 10 on page 54](#). This table also maps each requirement to specific NetWorker features.

Table 10 Accounting department backup requirements

Requirement	NetWorker feature	More information
Backups occur at the same time.	Backup Schedule Backup Group	“Task 1: Set up a schedule for backups” on page 56 “Task 2: Set up a group for backup clients” on page 57
Accounting backups for the past 3 months are available immediately.	Browse Policy	“Task 3: Set up policies for quick access and long term storage” on page 57
Accounting backups for the past 7 years are available, though not necessarily immediately.	Retention Policy	“Task 3: Set up policies for quick access and long term storage” on page 57
Backups are routed to volumes that can be identified as Accounting backup volumes.	Label Template Pools	“Task 4: Set up a label template to identify volumes” on page 58 (if Match Bar Code Labels attribute is not used for the Library resource) “Task 7: Set up a pool to sort backup data” on page 61
To avoid unnecessary backups, do not back up files with a .tmp extension.	Directives	“Task 5: Set up directives for special processing” on page 59
The same files and folders are backed up on each accounting computer.	Client resource	“Task 6: Create a backup Client resource” on page 59
Non-accounting data need only be recoverable for one year.	Browse Policy Retention Policy Client resource	“Task 3: Set up policies for quick access and long term storage” on page 57 “Task 6: Create a backup Client resource” on page 59

Setting up a scheduled backup

You can create a scheduled backup quickly by using the Client Backup Configuration Wizard or through manual configuration in the Console.

Using the Client Backup Configuration Wizard

The Client Backup Configuration Wizard provides the ability to:

- ◆ Create Client resources for scheduled backups.
- ◆ Create Group resources.
- ◆ Add new clients to existing backup groups.
- ◆ Modify existing client configurations.

The wizard supports NetWorker servers and clients in a stand-alone or cluster environment.

Note: The Client Backup Configuration wizard cannot be used to configure a NetWorker NDMP client or clients for NetWare.

Client Backup Configuration Wizard requirements

This section contains requirements or constraints specific to the use of the Client Backup Configuration Wizard.

- ◆ The wizard user must:
 - Have NetWorker server and client privileges, or have root (UNIX) or Administrator (Windows) privileges.
 - Have Configure NetWorker privileges on the NetWorker server where the scheduled backup is to be configured.
 - ◆ The NetWorker server's host must be listed in the servers file on the client machine that is being configured for a scheduled backup.
 - ◆ Communication between the Console server, NetWorker client host, and NetWorker server must use **nsrauth** strong authentication.
 - ◆ The Console server, NetWorker client host, and NetWorker server must be using NetWorker 7.5 or later.
 - ◆ Multiple wizard hosts cannot access the same client machine simultaneously.
- ["Client wizard issues" on page 668](#) discusses known issues with the Client wizard.

Accessing the Client Backup Configuration Wizard

To access the Client Backup Configuration Wizard:

1. From the **Administration** window, click **Configuration**.
2. In the **Configuration** window, click **Clients**.
3. Add a client or modify an existing client:
 - To add a new client, select **Configuration** menu > **Client Backup Configuration** > **New**.
 - To modify an existing client, select the client and then select **Configuration** menu > **Client Backup Configuration** > **Modify**.

The wizard opens. If the wizard fails to open, ensure that all prerequisites in ["Client Backup Configuration Wizard requirements" on page 55](#) are met. Also check the NetWorker daemon log for additional details. ["Viewing log files" on page 663](#) provides more information.

Manually creating a scheduled backup in the Console

To exercise more control over scheduled backups than is possible by using the Client Backup Configuration wizard, complete these tasks:

- ◆ [“Task 1: Set up a schedule for backups” on page 56](#)
- ◆ [“Task 2: Set up a group for backup clients” on page 57](#)
- ◆ [“Task 3: Set up policies for quick access and long term storage” on page 57](#)
- ◆ [“Task 4: Set up a label template to identify volumes” on page 58](#)
- ◆ [“Task 5: Set up directives for special processing” on page 59](#)
- ◆ [“Task 6: Create a backup Client resource” on page 59](#)
- ◆ [“Task 7: Set up a pool to sort backup data” on page 61](#)

You do not have permissions to make configuration selections if the following error message appears while completing any task in this section:

`user user_name needs to be on administrator's list`

[“Managing server access” on page 440](#) provides information about getting permissions.

Note: [Appendix F, “MAC OS X Support”](#) provides information about backing up NetWorker clients on Mac OS X

Task 1: Set up a schedule for backups

A schedule can be applied to each client backup. [Chapter 4, “Backup Groups and Schedules”](#) provides information about schedules

To create a schedule for backups:

1. From the **Administration** window, click **Configuration**.
2. In the expanded left pane, select **Schedules**.
3. From the **File** menu, select **New**.
4. In the **Name** attribute, type a name for the schedule.
5. From the **Period** attribute, select **Week** or **Month**.
 - Select **Week** to create a weekly backup schedule. For example, if a full backup for a Friday is selected, every Friday will have a full backup.
 - Select **Month** to create a monthly schedule. For example, if a full backup for the first of the month is selected, every month will have a full backup on the first of the month.
6. Select a backup level for each day in the weekly or monthly period:
 - a. Select a day.
 - b. Right-click and from the **Set Level** menu, select a backup level.
7. If required, select an override backup level for any day. An override occurs once only for the selected day:
 - a. Select a day.
 - b. Right-click and from the **Override Level** menu, select a backup level.
8. Click **OK**.

Task 2: Set up a group for backup clients

A backup group specifies the time of day when a backup occurs. Creating groups for backup clients enables you to:

- ◆ Balance backup loads to reduce the impact on your network and the NetWorker server.
- ◆ Sort data to specific backup volumes. To sort data, groups are used in conjunction with backup *pools*.

[Chapter 4, “Backup Groups and Schedules”](#) provides information about groups.

To create a group:

1. From the **Administration** window, click **Configuration**.
2. In the expanded left pane, select **Groups**.
3. From the **File** menu, select **New**.
4. In the **Name** attribute, type a name for the group.
5. In the **Comment** attribute, type a description of the group.
6. For the **Start Time** attribute, type a new time, unless it is appropriate to maintain the default time of 3:33 A.M. Ensure that start times for different groups are far enough apart so that one group has completed backing up before the next group starts.
7. For the **Autostart** attribute, select **Enabled**.
8. In the **Printer** attribute, type the name of the printer on which bootstrap save set information will be printed. For information about setting up a printer on Microsoft Windows systems, see [“Using nsrlpr to print notifications” on page 450](#).
9. Click the **Advanced** tab.
10. For the **Client Retries** attribute, change the number of retries, if necessary. This value specifies the number of times the NetWorker software attempts to back up a failed client.
11. Click **OK**.

Task 3: Set up policies for quick access and long term storage

Backup clients specify two policies: a browse policy and a retention policy.

- ◆ A browse policy determines how long backup data will be available for quick recovery.
- ◆ A retention policy determines how long backup data will be available for recovery, though not necessarily quickly. For example:
 - If it is likely that accounting data would need to be recovered within the past year, a browse policy of one year would be appropriate.
 - If the same accounting data had to be recoverable for up to seven years even though the likelihood of needing to recover it was low, a retention policy of seven years would be appropriate.

[“About browse and retention policies” on page 158](#) provides information about browse and retention policies.

To create a policy:

1. From the **Administration** window, click **Configuration**.
2. In the expanded left pane, select **Policies**.
3. From the **File** menu, select **New**.
4. In the **Name** attribute, type a name for the policy. Choose a name that reflects the length of time for which the policy specifies. For example, if the policy is for 15 months, type 15 months.
5. In the **Comment** attribute, type a comment about the policy.
6. In the **Number of Periods** attribute, type the number of periods applied to the policy. For example, if you choose months for the **Period** attribute and 3 for the **Number of Periods** attribute, then the policy lasts for 3 months (one quarter).
7. From the **Period** list, select a **period**. This attribute works in conjunction with the **Number of Periods** attribute. For example, a quarterly policy is configured in terms of the number of months (3). A week as seven days beginning on Sunday, a month is the calendar month, and a year is the calendar year.
8. Click **OK**.

Task 4: Set up a label template to identify volumes

If you are not using tapes with barcode labels, and the **Match Bar Code Labels** attribute is not enabled for the Library resource, then every backup volume requires a unique label for identification. The NetWorker server creates a unique label for each volume by applying a label template. [Chapter 7, "Sorting Backup Data"](#) provides more information about label templates.

To create a label template:

1. From the **Administration** window, click **Media**.
2. In the expanded left pane, select **Label Templates**.
3. From the **File** menu, select **New**.
4. In the **Name** attribute, type a name for the label template.
5. In the **Comment** attribute, type a description for the label template.
6. In the **Fields** attribute, type the label's components. Place each label component on a separate line. The template can use any or all of these components, although at least one range component must be added:
 - Range of numbers — for example, 001-999
 - Range of lowercase letters — for example, aa-zz
 - Range of uppercase letters — for example, AA-ZZ
 - Character string — for example, AccountingRanges of numbers or letters change incrementally with each new label. For example:
 - First label: Accounting.001
 - Second label: Accounting.002
 - Third label: Accounting.003
7. Select a **Separator** and click **OK**. If no symbol is selected, the components will have no separators (for example, Accounting001).
8. Click **OK**.

Task 5: Set up directives for special processing

Directives are optional instructions that control how files and directories are processed during backup and recovery. For instance, one could use a directive to skip all temporary files (*.tmp) during backup.

Other common uses for directives include adding password-protection and data compression to scheduled backups. [Chapter 6, "Directives"](#) provides information about directives.

Note: Some operating systems contain files and directories that should not be backed up. Use directives to ensure that these files and directories are not backed up. ["Preconfigured global directive resources" on page 174](#) provides more information.

To create a directive:

1. From the **Administration** window, click **Configuration**.
2. In the expanded left pane, select **Directives**.
3. From the **File** menu, select **New**.
4. In the **Name** attribute, type a name for the directive.
5. In the **Comment** attribute, type a description for the directive.
6. In the **Directive** attribute, type the directive instructions. For example, to skip all files on C:\ that have a .tmp extension, type:

```
<< "C:\" >>
skip: *.tmp
```

7. Click **OK**.

Task 6: Create a backup Client resource

A client is both a physical computer with NetWorker client software installed on it and a NetWorker *resource* that specifies a set of files and directories to be included in a scheduled backup. A Client resource also specifies information about the backup, such as the backup schedule, the backup group, browse policies, and retention policies.

A single NetWorker client computer can have several Client resources, although clients with the same save set cannot be in the same group. For instance, suppose the accounting data on a computer should be backed up according to a different schedule than the operating system files on the same computer. To accomplish this, one could create two Client resources on each computer: one for accounting data and another for operating system data.

Another common reason to create multiple Client resources for the same computer is to back up large client file systems more efficiently. For instance, one could create two Client resources: one for each file system on a computer. Each Client resource could be scheduled to back up separately.

["Multiple clients from the same computer" on page 485](#) provides information about multiple Client resources.

To create a Client resource:

1. From the **Administration** window, click **Configuration**.
2. In the expanded left pane, select **Clients**.
3. From the **File** menu, select **New**.

4. In the **Name** attribute, type the hostname of the NetWorker client computer.
5. In the **Comment** attribute, type a description of the client. If multiple Client resources are being set up for the same host, type a comment that distinguishes the Client resources.
6. From the **Browse Policy** attribute, select a browse policy from the list. The browse policy determines how long backed-up data is available for quick access.
7. From the **Retention Policy** attribute, select a retention policy from the list. The retention policy determines how long backed-up data is available though not necessarily quickly.
8. Select the **Scheduled Backups** attribute.
9. From the **Directive** attribute, select a directive from the list, if applicable.
10. In the **Save Set** attribute, type the name of the files or directories to be backed up. Place multiple entries on separate lines. For example, to back up a log file directory named C:\log and all of the data under the directory named D:\accounting, the entries would look similar to:

```
C:\log
D:\accounting
```

Type **All** to back up *all* client data. For Microsoft Windows operating systems, the SYSTEM or Volume Shadow Copy Service (VSS) SYSTEM save sets that determine the client system's state should be backed up on a regular basis.

More information can be found in the following locations:

- [“Save sets” on page 61](#) provides information on using the All save set and the SYSTEM or VSS SYSTEM save sets.
- [“The All save set” on page 62](#) describes how the components of the All save set can differ significantly between the various supported Windows operating systems.
- [“Backing up a mapped drive” on page 95](#) provides information on backing up a mapped drive.
- [“Backing up Windows mount points” on page 81](#) provides information on backing up mount points and nested mount points.
- [“Scheduled backups of non-ASCII files or directories” on page 486](#) provides information on using non-English paths in the **Save Set** attribute.

Note: Some operating systems contain files and directories that should not be backed up. Use directives to ensure that these files and directories are not backed up. [“Preconfigured global directive resources” on page 174](#) provides information.

11. From the **Group** attribute, select a group from the list.
12. From the **Schedule** attribute, select a schedule from the list.
13. Select the **Backup renamed directories** attribute to back up the files and subdirectories of a renamed directory even if only the name of the directory has changed.

If this attribute is selected, and a directory is renamed, all files and subdirectories under that directory will be backed up during the next scheduled full or non-full backup. [“Support for backing up renamed directories” on page 96](#) provides more information about this feature.

14. Click **OK**. The client is now set up for scheduled backups.

To determine whether a client is enabled for scheduled backups, locate the client entry in the right pane and look for a check mark under the Scheduled backup column.

Task 7: Set up a pool to sort backup data

A backup pool is a collection of volumes to which backup data is written. Use pools to sort backup volumes so that the volumes are easy to locate when they are needed. [Chapter 7, “Sorting Backup Data”](#) provides more information about pools.

To create a backup pool:

1. From the **Administration** window, click **Media**.
2. In the expanded left pane, select **Media Pools**.
3. From the **File** menu, select **New**.
4. In the **Name** attribute, type a name for the pool. A pool is associated with a label template. Use a name that clearly associates the pool with the corresponding label template.
5. In the **Comment** attribute, type a description of the pool.
6. Select the **Enabled** attribute.
7. For the **Pool Type** attribute, select **Backup**.
8. In the **Label Template** attribute, select the matching label template.
9. Modify the attribute to use to direct specific backup data to the volumes belonging to this pool. Data can be sorted by group, backup clients, save sets, and backup levels. [“Using media pools” on page 184](#) provides more information about sorting criteria.
10. Click **OK**.

Save sets

A Client resource identifies the client data to be backed up. The collection of data items backed up during a backup session between the NetWorker server and the Client resource is called a *save set*. A save set can consist of the following:

- ◆ A group of files or entire file systems.
- ◆ Application data, such as a database or operating system settings.

Note: A save set is defined when a Client resource is created. [“Task 6: Create a backup Client resource” on page 59](#) provides information about creating a Client resource.

Scheduling predefined save sets for backup

In addition to entering files or file systems in the Save Set attribute of the Client resource, you can also type the names of predefined save sets when configuring the NetWorker client.

For Microsoft Windows Server 2003 that has no VSS client license or has VSS disabled, and for Windows XP Professional, these predefined save sets are available:

- ◆ All
- ◆ SYSTEM STATE (Windows only)

- ◆ SYSTEM DB (Windows only)
- ◆ SYSTEM FILES (Windows only)
- ◆ Automated System Recovery (ASR) (Windows Server 2003 with no VSS client license or with VSS disabled, and XP Professional only)

For Windows Server 2003 with VSS licensed and enabled, and for Windows Vista, Windows 2008, 2008 R2, and Windows 7 these predefined save sets are available:

- ◆ All
- ◆ VSS SYSTEM BOOT
- ◆ VSS SYSTEM FILESET
- ◆ VSS SYSTEM SERVICES
- ◆ VSS USER DATA
- ◆ VSS OTHER
- ◆ VSS ASR DISK (Windows Server 2003 only)
- ◆ DISASTER_RECOVERY:\

Note: To properly protect NetWorker client computers, all of the SYSTEM or VSS SYSTEM save sets must be backed up and recovered simultaneously. Failure to do so will yield unpredictable results.

Note: Windows SYSTEM save sets do not support deduplication.

For information about:

- ◆ SYSTEM, VSS SYSTEM, SHAREPOINT, and ASR save sets, see [Appendix A, "SYSTEM and VSS SYSTEM Save Sets."](#)
- ◆ Support for ASR, see [Chapter 23, "Support for Windows XP and 2003 Automated System Recovery."](#)
- ◆ Support for Disaster Recovery on Windows 2008 / 2008 R2 and Windows 7, see [Chapter 24, "Support for Windows 2008 / 2008 R2 / Windows 7 Disaster Recovery."](#)

The All save set

The All save set is the default save set used when a client is created:

- ◆ For UNIX operating systems, the All save set backs up all locally mounted file systems.
- ◆ For Windows operating systems, the All save set backs up all locally mounted file systems, critical volumes required for disaster recovery (Windows 2008, 2008 R2, and Windows 7 only), plus operating system files that determine the client's system state.

Be aware that the VSS writer files associated with the system state or with applications are skipped during the regular file system backup. These files are backed up after the regular file system backup. Files that are associated with the system state are backed up under the VSS SYSTEM savesets. Files that are associated with applications are backed up under their corresponding VSS savesets. When performing a recovery, system state files can be found under the VSS system savesets, which include the VSS SYSTEM BOOT:, VSS SYSTEM SERVICES:, and VSS SYSTEM FILESET: savesets. To recover the system state, it is

strongly recommended that you recover all three VSS savesets at the same time. [“Recovering the Windows system configuration” on page 341](#) provides more information about recovering the Windows system state.

- ◆ For Windows 2008, 2008 R2, and Windows 7 only, a new disaster recovery save set is introduced. This save set backs up the system state critical volumes for an operating system, and except for some applications such as clusters, Active Directory, DFS-R, and Windows Server Failover Cluster, can completely replace the VSS SYSTEM savesets. [Chapter 24, “Support for Windows 2008 / 2008 R2 / Windows 7 Disaster Recovery,”](#) provides more information.

[Table 11](#) provides a list of the save sets included in the All save set.

Table 11 Components in the All save set

Operating system	Files
UNIX	<p>Backs up all file systems listed in these locations:</p> <p>Solaris: /etc/vfstab HP-UX, HP Tru64, Linux, and SGI: /etc/fstab AIX: /etc/filesystems</p> <hr/> <p>Note: If a save set's name includes a symbolic link, recovery by save set ID is not supported.</p>
Windows 2008, 2008 R2, and Windows 7	<p>DISASTER_RECOVERY:\ (included in Full backup only) All local physical drives</p> <hr/> <p>Notes: You can revert the definition of the All save set to be equivalent to a Windows 2003 host with VSS licensed and enabled by using the VSS:DISASTER_RECOVERY=off keyword in the Save Operations attribute. Chapter 24, “Support for Windows 2008 / 2008 R2 / Windows 7 Disaster Recovery,” provides more information about using the All save set with Windows 2008, 2008 R2, and Windows 7.</p> <p>For Extensible Firmware Interface (EFI) systems, Windows Disaster Recovery backups are not supported. The All save set components for EFI hosts are equivalent to a Windows 2003 host that has VSS licensed and enabled.</p>
Windows Server 2003 with VSS licensed and enabled, and for Windows Vista or Windows Server 2008	<p>VSS SYSTEM BOOT VSS SYSTEM FILESET VSS SYSTEM SERVICES VSS USER DATA VSS OTHER VSS ASR DISK (Windows Server 2003 only) All local, physical drives</p>
Windows XP Professional, Windows Server 2003 with no VSS client license or with VSS disabled	<p>SYSTEM STATE SYSTEM DB SYSTEM FILES SHAREPOINT ASR All local, physical drives</p>
Mac OS X	All local and mounted volumes

Using the save set All to back up particular file systems

When there are multiple file systems locally mounted on the NetWorker host, you can use a keyword to back up only one type of locally mounted file system.

To back up only those locally mounted file systems of a particular type, type **All-filesystem** in the client's Save Set attribute. For example, to back up all locally-mounted ZFS filesystems on a Solaris host, type the following in the client's Save Set attribute:

```
All-zfs
```

Using the save set All to back up Solaris zones

One or more NetWorker Client resources can be set up for each global and non-global zone on a physical Solaris host. You can specify the All-local and All-global keywords in the Client resource's Save Set attribute to back up Solaris global and non-global virtual zones as follows:

- ◆ If the All-local keyword is specified for a global zone client, all non-global zones on the physical host will be backed up.
- ◆ If the All-global keyword is specified for a global zone client, then it is equivalent to specifying the All keyword except that all non-global zones on the physical host will be skipped.
- ◆ If the All-local or the All keyword is defined for a non-global zone client, only the non-global zone client on the physical host will be backed up.
- ◆ If the All-mounts keyword is specified for a non-global or global zone client, all currently mounted filesystems are backed up as long as the filesystem is not one that is normally skipped such as the NFS filesystem.

Manual backups

Manual backups enable users to make quick backups of a few files. Unlike scheduled backups, manual backups do not:

- ◆ Generate bootstrap files
- ◆ Back up indexes

This may present recovery problems if the indexes are recovered after a disaster, but before a scheduled backup has backed up the latest indexes. For this reason, scheduled backups are the preferred backup method. However, indexes can be saved manually by using the **savegrp** command. [“Performing a manual backup from the command prompt” on page 67](#) provides more information.

On Microsoft Windows, manual backups can be performed by using the graphical NetWorker User program. On UNIX and Linux, manual backups can be performed from only the command line.

Note: You can also start a scheduled backup manually. [“Starting a group immediately” on page 395](#) provides information about starting a scheduled backup group manually.

Performing a manual backup on Windows

Note: If performing a NetWorker User backup on a NetWorker server, see [“Excluding file type devices from a manual backup on Windows” on page 65](#).

The NetWorker User program cannot be used to back up deduplication data. Deduplication data must be backed up by using scheduled backups or from the command line.

To start a manual backup on Windows:

1. In the NetWorker **User** program, click **Backup**. [Chapter 1, “Overview”](#) provides general information about the NetWorker **User** program

Note: There are considerations to be aware of when performing a manual backup of SYSTEM or VSS SYSTEM save sets. [“Manual backups of the SYSTEM and VSS SYSTEM save sets” on page 65](#) provides more information.

2. In the left pane of the **Backup** window, click the appropriate directory folder.
3. Select each directory or file, and click **Mark**. To clear an item, click **Unmark**.
4. Click **Start** to begin the manual backup. The **Backup Status** dialog box displays the progress of the backup.

When the backup finishes, a message similar to this appears:

```
Backup completion time: 2-15-07 3:27p
```

If the backup fails due to a problem with VSS or a writer, an error message appears. Use the Windows **Event Viewer** to examine the event logs for more information. VSS backup error messages are also written to the NetWorker log file.

Note: Certain kinds of corrupt files or errors on computer disk volumes are not detected. NetWorker might back up this corrupt data. To avoid this situation, run diagnostic programs regularly to correct disk volume errors.

Excluding file type devices from a manual backup on Windows

When performing a NetWorker User backup on a NetWorker server or storage node that is backing up to a local file type device, do *not* include the local file type device in the backup. If the local file type devices are included, the backup file will grow until there is no more disk space. The following procedure must be performed before selecting any files for backup or archiving, or before performing any activities from the Operation menu of the NetWorker User program.

To ensure that file type devices are excluded from NetWorker User backups, create a local directive on the NetWorker server as follows:

1. Start the NetWorker **User** program.
2. From the **Options** menu, select **Local Backup Directives**.
3. Click the filename of any file device to unmark it.
4. From the **File** menu, select **Save Directive**. This creates a directive file named `networkr.cfg`. [“Local directives within the NetWorker User program” on page 173](#) provides more information about the `networkr.cfg` file. [Chapter 11, “Device Operations”](#) provides information about file type devices.

Manual backups of the SYSTEM and VSS SYSTEM save sets

This section discusses manual backups of the SYSTEM or VSS SYSTEM save sets. These save sets are used to back up Windows system files. [Appendix A, “SYSTEM and VSS SYSTEM Save Sets”](#) provides more information.

Note: To back up and recover SYSTEM and VSS SYSTEM save sets, you must have local Windows Administrator privileges.

Manual backups of the SYSTEM and VSS SYSTEM save sets from the NetWorker User Program

In the NetWorker User Backup window, each of the SYSTEM or VSS SYSTEM save sets appear as a distinct node in the left pane. Expanding any of these nodes reveals its components in the right pane, as shown in [Figure 7 on page 66](#) and [Figure 8 on page 66](#).

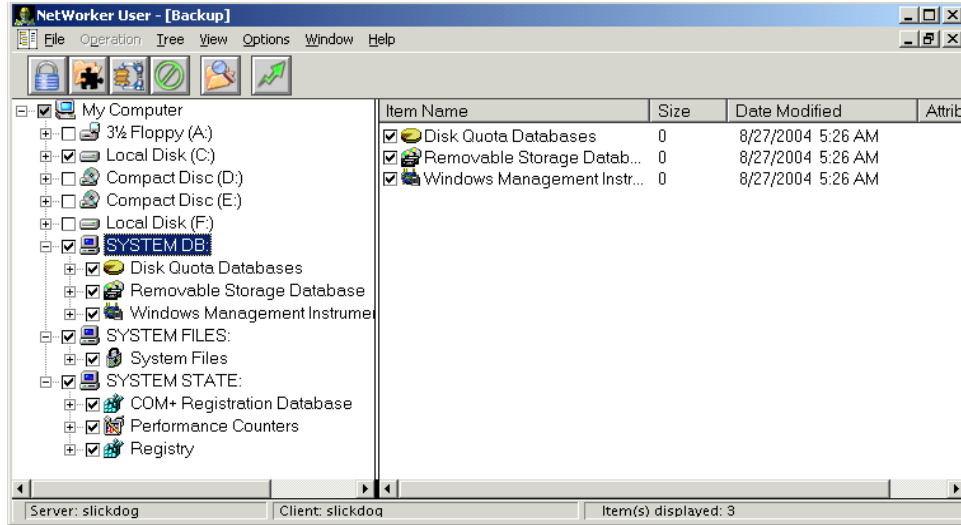

Figure 7 SYSTEM save sets in NetWorker User backup window

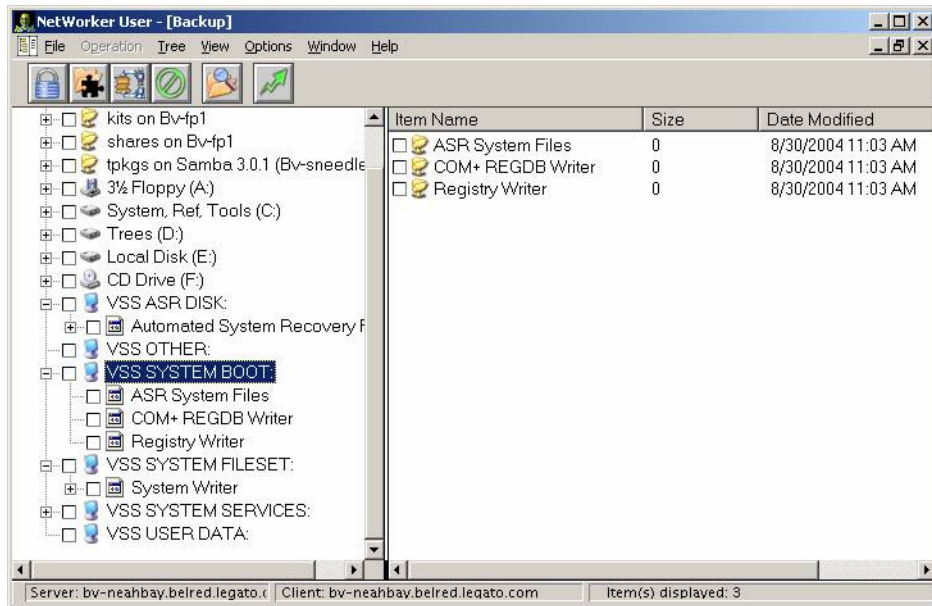

Figure 8 VSS SYSTEM save sets in NetWorker User backup window

The nodes that appear in the right pane reflect save set components that were eligible for backup at the time the NetWorker User program was started. After the NetWorker User Backup window is opened, the display does not dynamically refresh to reflect save set components that have since become eligible or ineligible for backup. However, all the eligible save set components are included in a backup when the backup operation starts, including those components that become available after the NetWorker User program starts.

Note: The NetWorker User program's special handling features (password-protect, encrypt, or compress) cannot be used when any of the SYSTEM or VSS SYSTEM save sets are marked for backup.

Performing a manual backup from the command prompt

A manual backup can also be performed from the command prompt by using the **save** command. For example, to back up C:\myfile to the server *jupiter*, type:

```
save -s jupiter C:\myfile
```

If you do not specify the **-s** option with the **save** command, the file(s) will be backed up to the NetWorker server defined in the /nsr/res/servers file that comes first in alphabetical order.

Note: You can also manually back up the bootstrap and indexes for a group by using the **savegrp** command with the **-O** option and a group name.

The *EMC NetWorker Command Reference Guide* or the UNIX man pages provides information about **save** and **savegrp**.

Manual backups of the SYSTEM and VSS SYSTEM save sets

A manual backup of the SYSTEM and VSS SYSTEM save sets can also be performed from the command prompt.

With no VSS licence or VSS disabled

This section describes how to back up SYSTEM save sets on a NetWorker client that is running:

- ◆ Windows Server 2003 with no VSS license or VSS disabled
- ◆ Windows XP Professional

To back up all components of the Windows system state:

```
save [-s NetWorker_server_name] "SYSTEM STATE:"  
save [-s NetWorker_server_name] "SYSTEM FILES:"
```

To back up all components of the SYSTEM DB, SHAREPOINT, and ASR save sets:

```
save [-s NetWorker_server_name] "SYSTEM DB:"  
save [-s NetWorker_server_name] "SHAREPOINT:"  
save [-s NetWorker_server_name] "ASR:"
```

With VSS enabled

This section describes how to back up VSS SYSTEM save sets on a NetWorker client that is running Microsoft Windows Server 2003 with VSS licensed and enabled:

To back up all components of the Windows system state:

```
save [-s NetWorker_server_name] "VSS SYSTEM BOOT:"  
save [-s NetWorker_server_name] "VSS SYSTEM FILESET:"
```

To back up all components of the VSS SYSTEM SERVICES, VSS USER DATA, VSS OTHER, and VSS ASR DISK (Windows 2003 only) save sets:

```
save [-s NetWorker_server_name] "VSS SYSTEM SERVICES:"  
save [-s NetWorker_server_name] "VSS USER DATA:"  
save [-s NetWorker_server_name] "VSS OTHER:"  
save [-s NetWorker_server_name] "VSS ASR DISK:"
```

Requirements and limitations

When backing up SYSTEM or VSS SYSTEM save sets from the command line, these requirements and limitations apply:

- ◆ Do not select individual components of any of the SYSTEM or VSS SYSTEM save sets for backup.
- ◆ A maximum of one SYSTEM or VSS SYSTEM save set can be included in the same **save** command.
- ◆ File system directories cannot be specified in the same **save** command.
- ◆ A maximum of one SYSTEM or the VSS SYSTEM save set can be specified in an input file.

Note: An input file is specified in a **save** command with the **-I** option.

File system directories cannot be specified in an input file.

Examples of invalid command line entries include:

```
save -s servername "SYSTEM DB:" "SYSTEM STATE:"
save -s servername D:\letters "SYSTEM DB:"
save -s servername -I D:\list.txt
```

where **list.txt** is an input file. Examples of invalid input files include:

- ◆ The following input file is invalid because it includes a file system and a VSS SYSTEM save set:
D:\letters
VSS SYSTEM BOOT:
- ◆ The following input value file is invalid because it includes multiple VSS SYSTEM save sets:
VSS SYSTEM BOOT:
VSS SYSTEM SERVICES:

Examples of valid command line entries include:

```
save -s servername "VSS SYSTEM BOOT:"
save -s servername "VSS SYSTEM SERVICES:"
```

Note: If the backup fails due to a problem with VSS or a writer, an error message appears. Use the Windows Event Viewer to examine the event logs for additional information. VSS backup error messages are also written to the log file (*networkr.raw*) on the local client.

Backing up multiple SYSTEM save sets

To back up multiple SYSTEM or VSS SYSTEM save sets in one operation, choose one of the following options:

- ◆ In the NetWorker Administration window, edit the Client resource to include multiple SYSTEM or VSS SYSTEM save sets. Alternatively, select the default save set **All**, which will include all SYSTEM and VSS SYSTEM save sets.
- ◆ In the NetWorker User program, mark all of the required SYSTEM or VSS SYSTEM save sets as well as any other required save sets, and then complete the backup.

Verifying backed-up data

Note: This feature is not available on UNIX clients.

Use the NetWorker Verify feature to ensure that backup data on the NetWorker server matches the data on the local disk. The Verify feature compares the file types, file modification times, file sizes, and file contents. It does *not* verify other system attributes, such as read-only, archive, hidden, system, compressed, and file access control list (ACL). The NetWorker server alerts you to any changes that have occurred to your data since the backup. Verification also determines whether a hardware failure kept the NetWorker server from completing a successful backup. The Verify feature provides a way to test the ability to recover data.

Note: To verify files, you must have Windows Administrator privileges for the computer.

To verify backup data:

1. In the NetWorker **User** program, select **Verify Files** from the **Operation** menu.
2. Select the data items to be verified.
3. Click **Start**.

You can monitor the data verification progress in the Verify Files Status window. After the verification is complete, the Verify Status dialog box shows any data discrepancies.

Probe-based backups

The NetWorker server schedules probe-based backups that are based on user-defined events for clients and NetWorker modules, not just on time.

To run probe-based backups, perform the following tasks:

1. Create a user defined client probe, as described in [“Creating a client probe” on page 473](#).
2. Associate a probe with a Client resource, as described in [“Associating a probe with a Client resource” on page 474](#).
3. Create a probe group, as described in [“Creating and scheduling a probe group” on page 132](#).
4. Run the probe group the same as you would a save group, as described in [“Scheduled backups” on page 54](#), or [“Manual backups” on page 64](#).

Note: Running `savegrp -g` bypasses probing when running a probe group backup from the command line.

Checkpoint restart backups

The checkpoint restart feature allows a failed backup operation to restart at a known good point prior to the point-of-failure during the backup. A known good point is defined as a point in the backup data stream where the data was successfully written to tape and that data can be located and accessed by subsequent recovery operations.

This feature allows client backups that are part of a scheduled backup to be restarted, if they fail while running. This prevents the files and directories that have already been backed up from being backed up again.

IMPORTANT

Checkpoint restart is only supported by both NetWorker 7.6 SP1 server and clients. Previous versions of NetWorker software do not support this feature. If either the NetWorker server or client is an earlier version, then the checkpoint restart feature is not supported.

Backup failures can occur for various reasons. The most common reasons include hardware failures, loss of network connectivity, and primary storage software failures. The NetWorker server and storage node components must remain running to manage the client failure and to create a partial save set. If the NetWorker server or storage node components fail during a backup, partial save sets will not be created. In this case, backup for the checkpoint-enabled client would have to be started from the beginning.

If the checkpoint restart feature has not been enabled, a failure encountered during a scheduled backup operation might require a re-run of an entire backup tape set. This can be costly when a limited backup window of time is available, as a significant portion of the backup data might have been successfully transferred to tape, and NetWorker cannot resume a save set from the point of interruption.

For example, when performing a 800 GB backup that requires approximately 10 hours to complete and spans 6 tapes, if a failure occurs while writing to the last tape the previous 5 tapes representing 9 hours of backup time may need to be re-run. As data sets continue to increase in size, so does the impact of backup failures.

Note: Configuring a client as checkpoint-enabled might impact the backup speed. This is dependent upon the data zone environment and configuration.

Checkpoint enabled clients provide the following enhancements:

- ◆ Failed save sets are marked as partial; not as aborted.
- ◆ Restarted save sets have a new SSID and savetime.
- ◆ Partial save sets are indexed.
- ◆ Partial save sets are not removed from the index, the media databases, and media such as AFTD.

The Checkpoint option will be ignored for index and bootstrap save sets.

Note: The checkpoint restart feature is not enabled by default. If a NetWorker client is not configured as checkpoint enabled and a backup fails, the next time when the group is run, the software creates a new save set from the beginning.

This section includes the following information about the checkpoint restart feature:

- ◆ [“About partial save sets” on page 71](#)
- ◆ [“Configuring checkpoint enabled clients” on page 71](#)
- ◆ [“Monitoring checkpoint enabled backups” on page 72](#)
- ◆ [“Restarting a checkpoint enabled backup” on page 73](#)
- ◆ [“How to query partial save sets from the Console” on page 74](#)
- ◆ [“How to query partial save sets using the mminfo command” on page 74](#)

- ◆ “Recovering data” on page 75
- ◆ “Cloning and scanning partial savesets” on page 76
- ◆ “Cloud backup devices and partial savesets” on page 76

About partial save sets

The backup sequence of partial save sets is not the same as for complete backups. Each partial save set provides protection for a part of the filesystem, but the completeness and consistency of the coverage of the whole filesystem cannot be guaranteed.

The checkpoint restart window is user-defined and can be large. If restarted hours apart, the partial backups might provide an image of the filesystem that is different from the state of the filesystem at any given point-in-time. The resulting filesystem is not guaranteed to be consistent. It can be different than at any other point-in-time.

Files and directories are backed up in alphabetical order. If a crash occurs, subsequent backups continue from the last point alphabetically from where they were in progress. Previously backed up files or directories are not reviewed for modifications. If a file or directory that is earlier alphabetically was modified or added, it will not be backed up.

Example A backup is interrupted while saving a directory and restarted after the directory contents have changed. As a result, different files are saved than the original filesystem entry.

For example:

1. A save set contains */disk1/dir*. The files include *file_a*, *file_c* and *file_d*.
2. A point of interruption occurs in the backup of the save set when *file_d* is being backed up.
3. The first partial save set contains *file_a* and *file_c*.
4. Before the checkpoint restart is initiated for the save set, *file_b* is added to the filesystem.
5. The second partial save set contains *file_d* and */disk1/dir*.

Note: */disk1/dir* contains *file_a*, *file_b*, *file_c*, and *file_d*.

6. Notice that *file_b* has not been backed up.

Configuring checkpoint enabled clients

NetWorker clients can be configured to allow an interrupted backup to restart from the point-of-failure at the directory or file level. The checkpoint restart feature is not enabled by default.

IMPORTANT

Configuring a client as checkpoint enabled might impact the backup speed. This is dependent upon the data zone environment and its configuration.

To configure a client for checkpoint enabled backups:

1. From the **Administration** window, click **Configuration**.

2. Set the **Checkpoint enabled** attribute:
 - a. In the expanded left pane, select **Clients**.
 - b. Right-click the client to be enabled, then select **Properties**. The **Properties** dialog box appears.
 - c. Click the **General** tab.
 - d. Click the **Checkpoint enabled** checkbox.
3. For the **Checkpoint granularity** attribute:
 - a. Select whether to restart the backup **by directory** or **by file**:
Restart by directory is the default. After each directory is saved, the data is committed to the media and index database. If a directory contains a large number of entries, intermediate checkpoints are created.



IMPORTANT

Use restarting by file only for save sets with few large files. Committing every file to the index and the media database is time consuming. This might lead to performance degradation during a backup that contains many small files.

- b. Click **OK**.
4. Select the group to which the checkpoint enabled client belongs.
 - a. In the expanded left pane, select **Groups**.
 - b. Click the **Advanced** tab.
 - c. If desired, change the **Client Retries** attribute to a value greater than 0. This value specifies the number of times the NetWorker software attempts to back up a failed client.
 - d. Click **OK**.

Monitoring checkpoint enabled backups

To view detailed information about a checkpoint enabled backup:

1. From the **Administration** window, click **Monitoring**.
2. Click **Groups** in the docking panel.
3. Right-click the group to which the checkpoint enabled client belongs, then select **Show Details**. The **Group Details** dialog box appears.
4. View detailed information related to the group backups:
 - If the partial save set is in the group's work list, it displays in the **Waiting to Run** section.
 - If the partial save set is running, it displays in the **Currently Running** section.
 - If the entire partial save sets sequence of the savegrp is complete, it displays in the **Completed Successfully** section.
 - If the entire partial save sets sequence of the savegrp is not complete, it displays in the **Failed** section.

Note: If any messages are generated, the **Show Messages** button is enabled. Click **Show Messages** to view the messages.

5. Click **OK** to close the **Group Details** window.

Restarting a checkpoint enabled backup

Restarting a checkpoint enabled backup of a partial save set is faster than restarting the backup of a save set from the beginning. This depends on how much data was saved in the previous backup.

There are two ways in which a checkpoint enabled backup can be initiated:

- ◆ Manually through a group restart operation.
- ◆ Automatically through setting the client retries attribute in the group resource of the checkpoint enabled client.

Note: Changing the name of a save set will cause checkpoint restart to fail to find a match against a previous run, and the restart will revert to a complete backup. Additionally, do not modify browse or retention policies for the client in between checkpoint restarts, as an expired partial save set may leave gaps in the backup set.

Manually restarting a checkpoint enabled backup by using the Group Restart attribute

When a group is restarted, the NetWorker software determines which save sets were not completed within the backup:

- ◆ If the client is enabled for checkpoint restart, the incomplete save sets are checkpoint restarted and continue from the point at which they were stopped.
- ◆ If the client has not been checkpoint enabled, the incomplete save sets are backed up again in full.

To manually initiate a group restart:

1. Ensure that the client has been check-point enabled. "[Configuring checkpoint enabled clients](#)" on page 71 provides detailed information.
2. From the **Administration** window, click **Monitoring**.
3. Click **Groups** in the docking panel.
4. Right-click the group to which the checkpoint enabled client belongs, then select **Restart**.
5. Click **Yes** to confirm the restart.

Setting the Client Retries attribute

If the NetWorker server fails to connect to a client, the **Client Retries** attribute specifies the number of times that the server will reattempt the connection to the client before the backup is considered a failure.

If the NetWorker software detects that the backup failed and the number of client retries is not exceeded, the software will checkpoint-restart the backup. This operation takes into account the group restart window and will not restart the backup if the backup window has expired.

To increase the number of times each client in a group is retried before the backup attempt is considered unsuccessful, change the value in the **Client Retries** attribute in the Group resource. “[Configuring checkpoint enabled clients](#)” on page 71 provides information on setting the **Client Retries** attribute.

How to query partial save sets from the Console

To view information on the partial save sets:

1. In the **Administration** window, click **Media**. Media-related topics appear in the navigation tree.
2. Select **Save Sets**. The following tabs appear in the **Save Sets** window:
 - Query Save Set
 - Save Set List
3. Select the **Query Save Set** tab to query:
 - All partial save sets, select **Checkpoint Enabled**.
 - All partial save sets with the same Checkpoint ID, in the **Checkpoint ID** field, type the Checkpoint ID of the partial save set on which you want to perform the query.
4. Select the **Save Set List** tab to view the result of the save set query:
 - The **Checkpoint ID** column displays the partial save set Checkpoint ID and its Sequence ID. The Checkpoint ID is listed first followed by the Sequence ID, which is encased within brackets.
 - Sort the **Checkpoint ID** column to view the complete sequence of partial save sets.
 - The **Status** column displays the status of the partial save sets:
 - **Checkpoint browsable** indicates that the save sets can be browsed.
 - **Checkpoint aborted** indicates that the backup of the partial save set was stopped or aborted.

Note: If no partial save sets are found that match the query, ensure that the backup of the partial save sets was started within the Save Time period. To change the values for the **Save Time** attribute, open the **Save Set Query** tab and select a date and time from the **Save Time calendar**.

How to query partial save sets using the `mminfo` command

By default, the `mminfo` command output only displays the browsable save sets. The first and intermediate partial save sets are not displayed. Only complete checkpoint enabled save sets or final partial save sets are displayed.

Use the `mminfo` command with specific queries to display more information about checkpoint-enabled save sets.

The following new media attributes have been added to the `mminfo` command to support the checkpoint restart feature:

- ◆ `checkpoint_id` — Displays the checkpoint restart id of the partial save set in the `chkpt_id` column
- ◆ `checkpoint_seq` — Displays the partial save set sequence id in the `chkpt_seq` column.

- ◆ `checkpoint-restart` — The flag attribute is used to only display checkpoint restart enabled save sets.

In addition, several media sumflags are used with the checkpoint restart feature:

- ◆ `k` — Indicates this is a checkpoint enabled save set
- ◆ `a` — The first and all intermediate partial save sets of a checkpoint sequence will have aborted status.
- ◆ `b` — The last partial or complete save set of a checkpoint sequence will be marked browseable.

Displaying checkpoint enabled save sets

To display all checkpoint enabled save sets, type the following command:

```
# mminfo -q 'checkpoint-restart' -r 'client, nsavetime, ssid(11),
sumflags(3), name, checkpoint_id, checkpoint_seq'

client save time ssid flnamechkpt_id chkpt_seq
plapew12519103034204700319cak/space/work/test_dir12519103031
plapew12519103274187923127cbk/space/work/test_dir12519103032
plapew12519107104087260214cak/space/work/test_dir12519107101
plapew12519107254070483013cbk/space/work/test_dir12519107102
```

Displaying all partial save sets for the checkpoint id

To display all partial savesets for the Checkpoint id, type the following command:

```
# mminfo -q "checkpoint_id=1251910303"

volumeclientdatesizelevelname
plapew.001plapew09/02/0917 MBfull/space/work/test_dir
plapew.001plapew09/02/09799 MBfull/space/work/test_dir
plapew.001.ROplapew09/02/0917 MBfull/space/work/test_dir
plapew.001.ROplapew09/02/09799 MBfull/space/work/test_dir
```

Recovering data

This section outlines how to recover data in the following two scenarios:

- ◆ [“How to recover data from the complete sequence of partial backups that comprise the original save set” on page 75](#)
- ◆ [“How to recover data from a partial save set” on page 76](#)

How to recover data from the complete sequence of partial backups that comprise the original save set

File-by-file recover is available only if there is a complete sequence of partial save sets that span the original save set. The directory structure is saved after the files are saved. If the directory structure is not available, then the browser cannot access the files.

To restore data from a complete sequence of partial save sets that comprise the original save set:

1. Perform a query for all partial save sets. [“How to query partial save sets from the Console” on page 74](#) provides detailed information.
2. If the sequence of partial save set comprises the original save set, use one of the following programs to restore the data:
 - For Windows - The **NetWorker User** program
 - For UNIX and Mac OS - The **nwrecover** program

Note: If the sequence of partial save set is incomplete and does not comprise the original save set, use the save set recovery procedure to recover the data from the partial save set. [“How to recover data from a partial save set” on page 76](#) provides more information.

How to recover data from a partial save set

Save set recovery enables you to recover data from a partial save set rather than by browsing and selecting individual files for recovery. However, the partial save set only contains successfully backed up files and not the entire set of data. An incomplete set of partial save sets cannot be browsed.

The procedure to restore data from partial save sets is the same as recovering by save set selection. [“Recovering by save set selection” on page 325](#) provides detailed information on performing data recovery.

nsrinfo can be used to display the contents of a partial save set. The **nsrinfo** man page or the NetWorker command line reference guide provides more information on using the **nsrinfo** command.

Cloning and scanning partial savesets

Partial save sets can be cloned and scanned individually. These operations must be performed on every partial save set.

If automatic cloning has been enabled, all partial save sets are cloned since automatic cloning is run as part of the scheduled backup.

Cloud backup devices and partial savesets

By default, the CheckPoint Restart feature does not support cloud backup devices because partial save sets are not retained on cloud backup devices.

Workaround

When the cloud backup device is used as a backup device for a Checkpoint Restart operation, on the Server Properties menu, enable the Keep Incomplete Backups attribute.

If the Keep Incomplete Backups attribute is *not* enabled, the NetWorker software will not keep the partial savesets.

Deduplication backups

The *NetWorker Avamar Integration Guide* provides more information about Avamar deduplication backups. The *EMC NetWorker Data Domain Devices Integration Guide* provides more information about Data Domain deduplication backups.

BMR backups

NetWorker clients can be configured to take advantage of EMC HomeBase bare metal recovery (BMR) technology to ensure that a client can be restored or migrated from one hardware type to another. When a backup is run on a client, a HomeBase profile is automatically generated and saved to a specified HomeBase Server. This process is enabled with a HomeBase Agent license. [“Support for HomeBase” on page 655](#) provides detailed information about configuring and enabling a NetWorker client for BMR support.

Encrypting backup data

Backup and archive data on UNIX and Windows hosts can be encrypted with the **aes** Application Specific Module (ASM). The **aes** ASM provides 256-bit data encryption. Backup data is encrypted based on a user-defined pass phrase. If no pass phrase is specified, data is encrypted with a default pass phrase.

IMPORTANT

Do not use AES encryption when backing up files that are encrypted by using the Microsoft Windows Encrypting File System (EFS). Even though the backup will be reported as successful, recovery of the file will fail and the following message will be written to the NetWorker log file:

recover: Error recovering <filename>. The RPC call completed before all pipes were processed.

Note: AES data encryption is supported in NetWorker release 7.3 and later. For compatibility with earlier NetWorker releases, PW1 password protection and PW2 encryption are supported.

Set the Datazone pass phrase for a NetWorker server

To set the Datazone pass phrase:

1. From the **Administration** window, click **Configuration**.
2. Select the server name.
3. From the **File** menu, select **Properties**.
4. Click the **Configuration** tab and type a pass phrase in the **Datazone pass phrase** attribute.
5. Click **OK**.

Note: By default, the current Datazone pass phrase is automatically used to recover password-protected files. If the current Datazone pass phrase was created after a password-protected backup was performed, you must provide the password that was in effect when a file was originally backed up. Keep password changes to a minimum.

Apply AES data encryption to clients in the datazone

To implement AES encryption, apply the Encryption global directive to individual clients by using the Directive attribute of the Client resource. For information about editing a Client resource, see [“Editing a client” on page 470](#).

Compressing backup data

Compressing data for a backup generates less network traffic. However, compression uses computing resources, so its benefits may be limited on low-powered systems. If the storage device also compresses data, the result may be that more data is actually written to tape.

Note: Both compression and password-protection cannot be selected.

Applying compression to a scheduled backup

To apply compression to a scheduled backup, use the **compressasm** ASM in a local or global directive. Alternatively, use a preconfigured directive that is appropriate for the client computer's operating system. "[Directives](#)" on page 169 provides information about creating and applying directives.

Applying compression to a manual backup

To compress data for a manual backup on Windows:

1. Mark the data to be compressed.
2. Select the **Special Handling** option from the **File** menu in the NetWorker **User** program. "[Special data handling for NetWorker clients on Windows](#)" on page 78 provides more information.

To compress data for a manual backup on UNIX, you must use the **compressasm** in a local directive file. "[Directives](#)" on page 169 provides more information.

Special data handling for NetWorker clients on Windows

To select directories and files for password-protection, encryption, and compression, or to clear a selected data item:

1. In the NetWorker **User** program, click **Backup**.
2. In the **Backup** window, select each data item to be designated for compression, encryption, or password-protection. If you select a disk volume or directory for an operation, the special handling will be applied to all of its nested subdirectories and files.
3. From the **File** menu, select **Special Handling**.
4. Select an option and click **OK**. You can also right-click the file and select a special handling option.

Depending on which special handling options were selected, the letter **P** (password-protection), **E** (encryption), or **C** (compression) displays next to the folder or filename.

To remove special handling, select a data item and click **Remove**.

Backing up NetWorker Console Management data

To protect NetWorker Console management data, such as report information, perform regular backups of the NetWorker Console database. The Console database remains available during the backup.

Note: The `savepsm` backup command backs up the Console database and also backs up the database credential file and the authentication configuration files in a separate save set named `CONSOLE_BACKUP_FILES`.

Scheduling backups for the NetWorker Console database

If a NetWorker server was specified during the setup of the Console server in the Console Configuration Wizard, a Client resource was created to back up the NetWorker Console database on a scheduled basis. If a Client resource was created, tailor the Client resource with respect to the backup schedule, browse and retention policies, and so on.

If a Client resource was *not* created to back up the NetWorker Console database, create a Client resource as follows:

1. From the **Console** window, click **Setup**.
2. From the **Setup** menu, select **Set Database Backup Server**.
3. In the **NetWorker server** attribute, type the name of the NetWorker server that will back up the Console server database.
4. Select the **Create client** resource on this server attribute.
5. In the **Client name** attribute, type the name of the Console server.
6. Click **OK**.

A Client resource is created with the following attributes:

- **Name** attribute: the name of the Console server computer.
- **Save Set** attribute:

`NMCASA:/gst_on_server_name/lgto_gst`

where `<server_name>` is the short name of the host where the Console server component was installed.

- **Backup Command** attribute: `savepsm` (for a Windows Console server) or `savepsm.sh` (for a UNIX Console server).

One can also specify a NetWorker server to back up the Console server database through the Console Configuration Wizard. [“Accessing the Console Configuration Wizard” on page 420](#) provides more information.

[“Setting up a scheduled backup” on page 55](#) provides information about creating and tailoring a Client resource.

Note: Only full, incremental, and skip backup levels are supported. All other backup levels (1 through 9) are mapped to an incremental backup.

Performing a manual backup of the Console database

Before performing a manual backup on UNIX, set the appropriate library path environment variable to:

- ◆ `<Console_install_dir>/sybasa/lib64`
- ◆ `<Console_install_dir>/sybasa/lib` (Linux)

The environment variable to set varies by platform:

- Solaris/Linux: LD_LIBRARY_PATH
- AIX: LIBPATH
- HP-UX: SHLIB_PATH

To perform a manual backup of the NetWorker Console database, type the following:

```
savepsm -I "<Console_install_dir>" save options
```

where `<Console_install_dir>` is the installation directory for the Console server. For example:

- ◆ On Solaris, the default installation directory is `/opt/LGTONmc`
- ◆ On Linux/AIX/HP_UX, the default installation directory is `/opt/lgtonmc`
- ◆ On Windows, the default installation directory is `C:\program files\legato\management\GST`

Installation directory paths that have spaces must be enclosed in quotations. For example:

```
savepsm -I "C:\program files\legato\management\GST" save options
```

The *EMC NetWorker Command Reference Guide* or the UNIX man pages provides information about the **savepsm** command.

Managing the size of the Console database log file

The Console database transaction log files are automatically truncated whenever a scheduled or a manual backup of the Console database is performed.

To truncate the transaction log file without performing a backup, type the **savepsm** command as follows:

```
savepsm -I "<Console_install_dir>" -T
```

Consideration for managing the Console database log file

If the transaction log file is truncated manually, the next backup of the Console database that is performed after truncation *must* be a full backup. The next backup can be either a scheduled backup or a manual backup.

To ensure that the next scheduled backup of the Console database is a full backup:

1. Open the backup schedule for the Client resource that is associated with the Console database.
2. If necessary, perform a manual override on the next scheduled backup so that it is a full backup. [“Editing a schedule” on page 145](#) provides formation about editing a backup schedule.

When performing a manual backup, a full backup is performed by default. [“Performing a manual backup of the Console database” on page 80](#) provides information about manual backups.

Backing up Windows mount points

A *volume mount point* (or mount point) is an NTFS file system feature of Windows 2008, 2008 R2, Server 2003, and Windows XP Professional.

Assigning a drive letter to a mount point is optional. Many disk volumes can be linked into a single directory tree, with a single drive letter assigned to the root of the host volume.

Note: NetWorker backup and recovery of mount points require special handling, as explained in this section.

Including mount points in scheduled backups

To include mount points and their data in scheduled backups, you must specify the host volume, and each mount point. For example, to back up a single mount point on drive D: and all of its data, include this in the client’s **Save Set** attribute:

D:*mountpoint_name*

To include nested mount points in scheduled backups, you can either specify save set All, or specify the host volume and the full path to each mount point. For example, to back up three nested mount points and their data on drive D:, include these in the client’s **Save Set** attribute:

D:*mountpoint_name1*

D:*mountpoint_name1**mountpoint_name2*

D:*mountpoint_name1**mountpoint_name2**mountpoint_name3*

[“Scheduled backups” on page 54](#) provides for more information about setting up a scheduled backup. [“Directory specifications” on page 176](#) provides information about including mount points and nested mount points in a backup directive.

Performing a manual backup of a mount point and its data

To back up a mount point and its data:

1. Start the NetWorker **User** program.
2. Click **Backup**.
3. In the **Backup** window, expand the host drive that contains the mount point to back up, for example, drive D:\.
4. Under D:\, select the *mountpoint_name*.
5. Expand the *mountpoint_name* and verify that all data beneath it is selected for backup.
6. Click **Start**.

[“Manual backups” on page 64](#) provides information about performing manual backups.

Performing a manual backup of nested mount points and their data

To perform a manual backup of nested mount points and their data, perform successive backup operations for each nested mount point and its data.

To back up three nested mount points and their data on drive D:\, for example:

1. Start the NetWorker **User** program.
2. Back up the top-level mount point and its data:
 - a. Click **Backup**.
 - b. In the **Backup** window, expand drive D:\ and mark *mountpoint_name1*.

Note: When you mark a mount point for backup, all files, directories, and nested mount points beneath it are marked by default. Before starting the backup, make sure only *mountpoint_name1* and the files and directories beneath it are marked. You must unmark any mount points nested beneath *mountpoint_name1*.

- c. Click **Start** to run the backup.
3. Back up the second mount point and its data:
 - a. Click **Backup**.
 - b. In the **Backup** window, expand D:\ and *mountpoint1*.
 - c. Select *mountpoint_name2* and its data.

Note: Be sure to clear (unmark) any mount points nested beneath *mountpoint_name2* before starting the backup.

- d. Click **Start** to run the backup.
4. Back up the third mount point and its data:
 - a. Click **Backup**.
 - b. In the **Backup** window, expand D:\, then expand *mountpoint_name1*, then expand *mountpoint_name2*.
 - c. Select *mountpoint_name3* and its data.
 - d. Click **Start**.

Backing up the Windows Content Index Server

The Windows Content Index Server (CIS) indexes the full textual contents and property values of files and documents stored on the local computer. The information in the index can be queried from the Windows search function, the Indexing Server query form, or a web browser.

Backing up CIS on Windows

The backup and recovery of the CIS occurs as part of the SYSTEM DB save set. If VSS is enabled, the CIS is automatically regenerated upon system reboot.

Note: Back up the SYSTEM STATE and the SYSTEM DB save sets whenever a CIS database is created, moved, or renamed.

Before a CIS backup, the NetWorker software performs the following:

1. Pauses any CIS catalogs that are to be backed up.
2. Backs up all files that belong to those catalogs.
3. Turns the catalogs on again when the backup is finished. A catalog can still be queried when it is paused, so no indexing functionality is lost during the CIS backup.

The CIS deletes the catalog folder during a backup and restores it as part of a recovery operation.

Troubleshooting problems with a CIS backup

To troubleshoot a problem with a CIS backup:

- ◆ Ensure that the catalog folder is named `catalog.wci`.
- ◆ Restart the CIS.
- ◆ Ensure that the CIS was installed correctly.
- ◆ Pause or stop the catalogs, and then try the backup again.

Directing NetWorker software to skip CIS catalog backups

To skip backing up the `catalog.wci` folder entirely, create a Directive resource in the NetWorker Console by typing the following:

```
[intentionally leave first line blank in this directive]
<< / >>
+skip: *.wci
```

[“Directives” on page 169](#) provides information about directives.

Backing up Windows DHCP and WINS databases

Windows Dynamic Host Configuration Protocol (DHCP) and Windows Internet Naming Service (WINS) databases are not included in the NetWorker SYSTEM DB save set. However, you can use the procedures in this section to configure NetWorker software to protect these databases.

Note: If VSS is licensed and enabled, the DHCP and WINS databases are automatically included when performing a backup of save set All. The procedures in this section are optional. [“Scheduled backups” on page 54](#) provides information about scheduling and recovering backups.

Backing up a DHCP database

To back up a DHCP database, ensure that this directory is included in the save sets for the NetWorker client that is the DHCP server, type:

```
%SystemRoot%\System32\dhcp
```

Backing up a WINS database

To back up a WINS database:

1. Use Microsoft WINS administrative tools to configure an automated backup of the WINS database to a local drive on the WINS server.
2. Ensure that the location chosen in [step 1](#) is included in the save sets for the NetWorker client that is the WINS server.

Note: The Microsoft documentation provides information about the Microsoft WINS administrative tools.

Windows backup and recovery notes

This section contains notes about the backup and recovery of data on Windows clients, including:

- ◆ [“Enabling short filename support” on page 84](#)
- ◆ [“Enabling hard link support” on page 85](#)
- ◆ [“Recovery and case-sensitivity” on page 85](#)
- ◆ [“Failed backup and recovery attempts” on page 85](#)
- ◆ [“Granting full permissions for backup of Disk Quota database” on page 85](#)
- ◆ [“Security settings for logging operations performed by backup operator” on page 86](#)

Enabling short filename support

On Windows Server 2003 and Windows XP Professional, NetWorker software provides backup and recovery support for the short filenames that are automatically assigned by the Windows filename mapping feature. Windows filename mapping is an operating system feature in which each file or folder with a name that does not conform to the MS-DOS 8.3 naming standard is automatically assigned a second name that does. For example, a directory named Microsoft Office might be assigned a second name of MICROS~2.s

To improve performance, support for short filenames is disabled by default.

To enable support for short filenames on a NetWorker client:

1. From the **Administration interface** window, click **Configuration**.
2. In the left pane, click **Clients**.
3. Right-click the appropriate client and select **Properties**.
4. Click the **Globals (2 of 2)** tab.
5. Select the **Short filenames** attribute.
6. Click **OK**.

Enabling hard link support

The NetWorker server backs up and recovers files with hard links. However, the hard links of files created by using a Portable Operating System Interface (POSIX) application are not preserved during recovery.

To improve performance, support for hard links is disabled by default.

To enable support for hard links on a NetWorker client:

1. From the **Administration interface** window, click **Configuration**.
2. In the left pane, click **Clients**.
3. Right-click the appropriate client and select **Properties**.
4. Click the **Globals (2 of 2)** tab.
5. Select the **Hard links** attribute.
6. Click **OK**.

Recovery and case-sensitivity

The NetWorker server is case-sensitive with regard to backup and recovery, although Windows file systems are not case-sensitive. This may result in the creation of multiple files with the same name but different cases.

For example, if you back up a file that is named temp.txt, delete it, then create a new file named Temp.txt, and then recover the old file, you will have two identical files in the directory -- one named temp.txt and the other named Temp.txt.

To avoid this problem, disable POSIX compliance by setting this system environment variable:

```
NSR_DISABLE_POSIX_CREATE=YES
```

The Windows online help contains detailed instructions about setting system environment variables.

Failed backup and recovery attempts

The NetWorker log file, located in <install_path>\logs\networkr.raw, contains a record of every file that was part of an attempted manual backup or recovery that was performed from the NetWorker User program. This file is overwritten with the next manual backup or recovery. If the file contains information that should be saved, you should rename the file or export the information by using the **nsr_render_log** program. [“Viewing log files” on page 663](#) provides information about viewing log files with the **nsr_render_log** program.

Granting full permissions for backup of Disk Quota database

NetWorker software backs up and recovers the Windows disk quota database as a component of the SYSTEM DB or VSS SYSTEM SERVICES save set. For any NetWorker client that uses the Windows Disk Quota feature, during SYSTEM DB or VSS SYSTEM SERVICES backup, NetWorker software creates temporary files to store the disk quota database settings in the root directory of each drive on the client. If the

permission settings for a local drive do not allow full control to the local system account, the disk quota database backup fails and an error message, similar to this, appears:

```
Failed to write to quota file, 0x80070005
```

To grant full permissions to the local system account:

1. Log in with administrator privileges to the NetWorker client host computer.
2. Using **Windows Explorer**, perform these steps for each local drive:
 - a. Right-click a drive icon.
 - b. In the **Properties** dialog box, select the **Security** tab.
 - c. Make sure the permissions settings allow full control to the system account.

Note: By default, everyone has full permissions. If that setting has been changed such that the system account does not have full permissions, you must grant full permissions to the system account in order for the disk quota database to be backed up. For more information on setting permissions, refer to the Microsoft Windows documentation.

Security settings for logging operations performed by backup operator

By default, members of the Windows Backup Operators group do not have write permission to the `<NetWorker_install_path>\logs` directory.

To enable NetWorker logging for Backup Operators, modify the security settings on the `<NetWorker_install_path>\logs` directory.

For example:

1. In **Windows Explorer**, navigate to the `<NetWorker_install_path>\logs` directory.
2. Right-click the `<NetWorker_install_path>\logs` directory icon and select **Properties**.
3. On the **Security** tab of the **Properties** dialog box, add the **Backup Operators** group to the list of groups and users.
4. Select the **Backup Operators** group and click **Allow Write**.
5. Click **OK**.

NetWorker logs operations performed by members of the Windows Backup Operators group.

Customizing the backup command

You can customize client backups by creating additional programs (scripts) that affect the way the NetWorker server backs up client file system data. For example, one can create a program that performs the following:

1. Shuts down a mail server or database *before* the NetWorker server performs a backup operation.
2. Restarts the mail server or database *after* the backup has completed.
3. Prints a message, such as, "Backup started at 3:33 A.M."
4. Executes the backup.

5. Prints a message, such as "Backup completed at 6:30 A.M."

You can customize a client's scheduled backups in one of two ways:

- By creating a script that invokes the **save** program as part of its instructions. When the client is backed up, the customized program is invoked instead of the standard **save** program. ["Using the save command with a customized backup script" on page 87](#) provides more information.
- By typing **savenpc** in the Backup Command attribute of the Client resource. This way, the client backup invokes the **savenpc** program instead of the **save** program. The first time the client is backed up, **savenpc** creates a default backup program file, which you can then customize for future backups of the client. ["Using the savenpc command with a customized backup program" on page 91](#) provides more information.

Using the save command with a customized backup script

Additional processing instructions can be specified by entering the name of a custom script in the Backup Command attribute in the Client resource. The script will be executed instead of the default **save** program, when scheduled backups are initiated. The instructions in the script run separately for each save set backed up for the client.

When you use the **save** program, a new instance of the customized script is invoked for each save set listed in the client's Save Set attribute, rather than just once for that client (as happens with **savenpc**). If you specify a save set value of All, the program is executed for each file system on the client. As a result, if you create a Client resource with a customized backup for a database, a command to shut down the database will be executed for each save set listed.

Note: After the creation of a customized backup script for a client, try backing up the client immediately. Any configuration or network problems that could prevent a backup should become apparent during this test.

The syntax used in the backup script or batch file must adhere to these criteria:

- ◆ The program name must begin with either the prefix *save* or *nsr* and must not exceed 64 characters.
- ◆ The program must reside on the client in the same directory as the NetWorker **save** command.
- ◆ Always specify the full path of the **save** command in the script.
- ◆ The NetWorker **save** command must be used in the backup program to ensure that the data is properly backed up.
- ◆ All commands within the program file must be successfully executed. Otherwise, the NetWorker server cannot complete the remaining instructions.
- ◆ On UNIX and Linux, when you invoke the NetWorker **save** command, invoke the command with these arguments: **save "\$@"**. Doing so enables the **save** command in the script to accept the arguments usually passed to it by the NetWorker **savefs** program during a routine backup operation.

Create a custom backup script by using the save program

To create a custom backup script by using the **save** program:

1. Use a text editor to create a script in the directory where the NetWorker **save** command resides.

Note: For custom backup scripts that are to run on Windows clients, the script name must start with **save** or **nsr** and must end with the **.bat** extension.

Commands in this script must be placed in this order:

- a. Run a preprocessing command before each save set backup (optional).
 - b. Back up the data by using the NetWorker **save** command (mandatory).
 - c. Run a postprocessing command after each save set backup (optional).
2. In the **Backup Command** attribute of the **Client resource**, type the name of the backup script.
 3. Back up the client to ensure that the newly created backup command works.

Example 3 The save Backup command on Windows

In this example, for each save set, the customized backup program executes pre-backup commands, runs the NetWorker **save** command, and then executes post-backup commands.

The backup program consists of these parts:

- ◆ **Pre-Backup Command:** Redirects the output of the Net start DOS command to create a **netstart.txt** file at the root of the C: drive and send all current computer Services Started information to this file.
- ◆ **Save:** Executes NetWorker commands to run the required backup process.
- ◆ **Post-Backup Command:** Redirects the output of the Set DOS command to a **set.txt** file at the root of the C: drive and send all computer system environment information to this file.

The **netstart.txt** and **set.txt** files are placed in the C:\ directory. New information is appended to these files each time a backup is run.

Also, you can check the batch file execution process in the Monitor Groups tab of the Administration window, or by viewing the **savegrp** log file in the <NetWorker_install_path>\logs directory.

[“Monitoring window” on page 392](#) provides information about viewing execution file details from the **Monitor Groups** tab.

[“Viewing log files” on page 663](#) provides information about viewing log files.

This is an example backup script:

```

@ECHO OFF
SETLOCAL
ECHO =====START BATCH FILE=====
ECHO =====NetWorker PRE_BACKUP COMMAND=====
ECHO =====NET START - creates netstart.txt file and
ECHO =====sends all Started Services information
ECHO =====to the file c:\netstart.txt

NET START >>C:\NETSTART.TXT

REM This command takes incoming arguments from
REM the savegrp command and handle them
REM to overcome batch file limitations:

REM PARSE ALL INCOMING ARGUMENTS
REM and pass single argument in case
REM more than 10 arguments are passed to this file
REM (ie %0-%9 is not enough).

ECHO =====NetWorker SAVE SET COMMAND=====
SHIFT
SET arg=%0

:loop
SHIFT
IF %0.==. GOTO save
SET arg=%arg% %0
GOTO loop

REM These are the save commands that run the required
REM NetWorker backup commands.

:save

REM Note: Enter correct path to your NetWorker bin
REM directory (line below is default path)
C:\PROGRA~1\nsr\bin\save.exe %arg%

ECHO =====NetWorker POST_BACKUP COMMAND=====
ECHO ====="SET" - creates set.txt file and sends all
ECHO =====computer system environment information to
ECHO =====C:\set.txt file=====

SET >>C:\SET.TXT

ECHO =====END OF BATCH FILE=====

ENDLOCAL

```

This information is displayed from the **Monitor Groups** tab, logged to the `sevegrp.log` file after the backup process is done, and verifies the execution of the three processes.

```

--- Successful Save Sets ---
:* jupiter:c:\inetpub =====START BATCH FILE=====
* jupiter:c:\inetpub ===NetWorker PRE_BACKUP COMMAND===
* jupiter:c:\inetpub=====NET START
* creates netstart.txt file and sends all started
* jupiter:c:\inetpub =====services information to
* that file c:\netstart.txt==

* jupiter:c:\inetpub ===NetWorker SAVE SET COMMAND====
* jupiter:c:\inetpub save: using `C:\Inetpub' for
* `c:\inetpub'
jupiter: c:\inetpub level=full,194 KB 00:00:02 37 files
* jupiter:c:\inetpub =====NetWorker POST_BACKUP COMMAND
* jupiter:c:\inetpub ====="SET" - creates set.txt
* file and sends all computer system
* jupiter:c:\inetpub ==== environment information
* to C:\set.txt file
* jupiter:c:\inetpub =====END OF BATCH FILE=====
jupiter: index:jupiter level=full, 243 KB 00:00:00 23 files
jupiter: bootstrap level=full, 47 KB 00:00:00 7
files
* jupiter:bootstrap nsrlpr: Either a printer isn't
* defined for printing the Bootstrap for
* this savegroup,
* jupiter:bootstrap 04/26/06 01:34:13 PM full
* 3901113601 3901113601 0
jupiter.001

```

Example 4 The save backup command on UNIX

This script backs up a ClearCase version object base (VOB). The script file must reside in the same directory as the NetWorker **save** command (for example, on a Solaris system, the **save** program is installed in the /usr/sbin directory). Type the name of the script into the Backup Command attribute of the Client resource that is used to back up the ClearCase VOB. As a result, this script is invoked instead of the usual **save** command during a scheduled backup.

Note: Include the **save** command in the script and place the script in the same directory as the **save** program. Otherwise, the backup will fail.

This script locks a ClearCase VOB, performs the backup, and then unlocks the VOB.

```
#!/bin/sh
# export the SHELL that we are going to use
SHELL=/bin/sh
export SHELL
# export the correct PATH so that all the required binaries can be
found
case $0 in
/* ) PATH=/usr/atria/bin:/bin:/usr/bin:`/bin/dirname $0`
c=`/bin/basename $0`
;;
* )PATH=/usr/atria/bin:/bin:/usr/bin:/usr/sbin
c=$0
;;
esac
export PATH

# These are the valid statuses that save reports upon completion of
the backup
statuses="
failed.
abandoned.
succeeded.
completed savetime="
"
# Perform the PRECMD (Lock VOB)
/usr/atria/bin/cleartool setview -exec
"/usr/atria/bin/cleartoollock -c \
'VOB backups in progress' -vob /cm_data/mis_dev" magic_view >
/tmp/voblock.log 2>&1
# Perform backup on client
save "$@" > /tmp/saveout$$ 2>&1
# cat out the save output
cat /tmp/saveout$$
# search for backup status in output reported by save
for i in ${statuses}; do
    result=`grep "${i}" /tmp/saveout$$`
    if [ $? != 0 ]; then
        echo ${result}
    fi
done
# Perform the POSTCMD (Unlock VOB)
/usr/atria/bin/cleartool setview -exec
"/usr/atria/bin/cleartoolunlock -vob
/cm_data/mis_dev" \
magic_view > /tmp/vobunlock.log 2>&
# exit gracefully out of the shell script
exit 0
```

Using the `savenpc` command with a customized backup program

As an alternative to using the `save` program with a custom script, use the `savenpc` program. The `savenpc` program differs from using a custom script with the `save` program in that preprocessing and postprocessing commands execute only once during the client backup, instead of once for each save set. This command can be useful if the client is running a database or other program that should be stopped before the client is backed up, and then restarted after the backup has completed. The options for the `savenpc` command are identical to those for the `save` command.

The *EMC NetWorker Command Reference Guide* or the UNIX man pages provides For information about the `savenpc` command.

To execute the **savenpc** program:

1. From the **Administration** window, click **Configuration**.
2. In the expanded left pane, select **Clients**.
3. Create a new Client resource or select an existing Client for editing.
4. Select the **Apps & Modules** tab.
5. In the **Backup Command** attribute, type:

```
savenpc
```

6. Back up the client.

The first time a backup group with a client that uses **savenpc** runs, a standardized *group-name.res* file is created in one of the following:

- The `/nsr/res` (UNIX)
- The `NetWorker_install_path\res` (Microsoft Windows) directory on the client where *group-name* is the same as the name in the Group resource selected for that client. If the client belongs to multiple backup groups, a separate *group-name.res* file is created for each group to which the client belongs.

The initial *group-name.res* file contains **type**, **preprocessing**, **postprocessing**, **timeout**, and **abort precmd with group** attributes:

```
type: savenpc;
precmd: "echo hello";
pstcmd: "echo bye";
timeout: "12:00pm";
abort precmd with group: No;
```

Note: The **abort precmd with group** attribute determines what will happen to the preprocessing command when the **savegroup** process aborts prematurely. By default, the preprocessing command process will not be killed if the **savegroup** process aborts prematurely. To kill the preprocessing command when the **savegroup** process aborts, set **abort precmd with group** to **Yes**.

Once the *group-name.res* file exists, use a text editor to customize the file's attributes. These customized instructions are then applied the next time the client is backed up.

Before performing a save operation on the client, the modified **savenpc** program performs the following:

- ◆ Any preprocessing commands listed for the **precmd** attribute in the *group-name.res* file.
- ◆ The save by using the options specified for the **savenpc** command itself.
- ◆ Any postprocessing commands listed for the **pstcmd** attribute.

When editing a *group-name.res* file, these points apply:

- ◆ The command environment that is opened by the **savenpc** command to run a customized backup does not automatically inherit the system's default environment. Specifically, environment variables, including `PATH`, will either not exist or will be set to `NULL`. The environment must be built as part of the preprocessing (**precmd**) commands, especially the `PATH` variable. On UNIX clients, be sure to source the `.profile`, `.cshrc`, and other login scripts.
- ◆ The **save** command should not be specified in the *group-name.res* file. The **savenpc** program will automatically invoke the **save** command and back up the save sets specified in the **Save set** attribute for the client.

- ◆ To exclude the environment variables in the *group-name.res* file, include full pathnames for all commands and files.
- ◆ Resident commands, for which there is no executable file present, like **time** and **dir**, will not work as commands in your *group-name.res* file. The log reports that the executable file could not be found.
- ◆ On a Microsoft Windows client, do not use "@ECHO OFF" in the *group-name.res* file.
- ◆ To add more than one command sequence to the **precmd** and **postcmd** attributes, insert a comma (,) to separate the commands.
- ◆ A complete command-line for an attribute must end with a semicolon (;).
- ◆ Escape any backslash (\) characters in the *group-name.res* file. For example, the pathname C:\mydir\myprogram.exe must be written C:\\mydir\\myprogram.exe.

This is an example of a fully functional *group-name.res* file:

```
type: savenpc;
precmd: "V:\\usr\\sap\\PDB\\SYS\\exe\\run\\PDB-stop.cmd >
C:\\WINNT\\system32\\PDBStop.log 2>&1";
postcmd: "V:\\usr\\sap\\PDB\\SYS\\exe\\run\\PDB-start.cmd
C:\\WINNT\\system32\\PDBStart.log 2>&1";
timeout: "12:00pm";
```

It is not necessary to escape any backslash characters in scripts called from the *group-name.res*. To simplify the pathname issue, include all commands in a script or batch file, and then include that script's full pathname on the **precmd** or **postcmd** line.

- A line break is required after the semicolon that ends the last command in the *group-name.res* file.
- The following applies to text written to standard output:
 - Text written during preprocessing appears in the NetWorker completion notices. You can direct this output to a log file.
 - Text written during postprocessing is discarded. Consider redirecting this output to a log file so you can troubleshoot problems.

Timeout attribute

The Timeout attribute indicates when the postprocessing commands are to be run, regardless of whether all of the save sets have been backed up or not. The timeout entry must be specified in **nsr_getdate** format and must be enclosed in double quotes. For more information about **nsr_getdate**, refer to the *EMC NetWorker Command Reference Guide* or the UNIX man pages.

If an invalid time is entered for the timeout, the timeout is not executed and no error message is produced.

The Timeout attribute is optional. To disable the Timeout attribute, add a comment character (#) to the beginning of the line, for example:

```
# timeout: "12:00pm";
```

The value of the Timeout attribute may not be the exact time that postprocessing actually commences. The **savenpc** program's **pstclntsave** subroutine uses a one-minute polling interval to check for the completion of preprocessing tasks. Therefore, the **savenpc** log file may show that postprocessing was started up to 60 seconds after the designated timeout.

Customize the `savepnpc` command for multiple groups

To customize pre- and postcommand processing for multiple groups:

1. Copy existing `group-name.res` files.
 - Microsoft Windows clients:
`NetWorker_install_path\tmp\group-name.res` to `NetWorker_install_path\tmp\your_new_group.res`
 - UNIX clients:
`/nsr/res/group-name.res` to `/nsr/res/your_new_group.res`
2. Edit the new `new_group-name.res` file.

If you do not have an existing `group-name.res` file, activate the group for `savepnpc` without the presence of this file. A default template will be created at one of the following:

- `/nsr/res/your_new_group.res`
- `NetWorker_install_path\res\your_new_group.res`

You can then customize the template.

Message logging by the `savepnpc` command

Messages generated by `savepnpc` are written to the `savepnpc` log file, located in these locations on the NetWorker client:

- ◆ UNIX: `/nsr/logs`
- ◆ Microsoft Windows: `NetWorker_install_path\logs`

The format of the `savepnpc` log file is similar to:

```
04/03/07 13:56:43 preclntsave: All command(s) ran successfully.
```

```
04/03/07 13:57:43 preclntsave: All save sets on the worklist are done.
```

[“Viewing log files” on page 663](#) provides information about viewing log files.

Considerations for backing up raw partitions

The NetWorker software must have exclusive access to a file system to perform a raw backup. Close as many applications as possible before doing a raw disk backup. If the raw partition contains data managed by an active database management system (DBMS), ensure that the partition is offline and the database manager is shutdown. For greater flexibility when backing up partitions that contain DBMS data, use a NetWorker Module application.

Backing up raw partitions on UNIX

To back up raw disk partitions on UNIX, use the `rawasm` directive. [“Precautions when using rawasm to back up UNIX raw partitions” on page 180](#) provides more information.

Backing up raw partitions on Windows

To back up a raw disk partition on Windows, specify the raw disk partition in a save set. Identify the raw partition as a physical drive or as a logical drive. For example:

```
save -s NetWorker_server_name \\.\PhysicalDrive0
save -s NetWorker_server_name \\.\C:
```

Backing up a mapped drive

To back up a mapped drive, follow these guidelines:

- ◆ To specify a drive to back up in either a scheduled or manual backup, do not specify the drive letter. Instead, specify the Universal Naming Convention (UNC) path.

For example, to specify the accounts directory on the server *jupiter*, type:

```
\\jupiter\accounts
```

- ◆ For scheduled backups:
 - Add the username required to access the UNC path to the **Remote User** attribute in the **Client** resource.
 - Add the password required to access the UNC path to the **Remote Password** attribute in the **Client** resource.

Backing up access control lists

The backup and restore of ACLs (Access Control Lists) and extended ACLs is fully supported. This support covers Linux, HP-UX, AIX, DEC, SOLARIS, OS/X, and Windows.

There is no special attribute or keyword that controls this support. When a file that has an associated ACL is backed up, the ACL is backed up along with the file data. When the file is recovered, any associated ACLs will also be recovered.

Backing up BOOT/BCD Data on Windows 2008R2 and Windows 7

In earlier versions of Windows operating system, the BOOT directory was present in the system drive. However, in Windows 7 and Windows 2008 R2, a hidden, unmounted system reserved partition is created and the BOOT Configuration Data (BCD) store is saved in this partition. The BCD store contains the boot configuration parameters and controls the computer's boot environment.

During a backup, NetWorker checks for the type of operating system. If it is Windows 7 or Windows 2008 R2, it ensures that the partition containing the BCD is mounted and then assigns a drive letter to the mounted partition and performs the backup of the BCD. The VSS BOOT BCD FILES get backed up as a part of the VSS SYSTEM FILE SET. After a backup, the partition is unmounted.

Support for backing up renamed directories

When a directory is renamed, the default behavior during a non-full level backup is to skip the unchanged files and folders under the renamed directory. This behavior can cause unexpected results during a recovery operation. If you attempt to recover data under a renamed directory from a date between the time that the directory was renamed and the next full level backup, it may appear that data is missing. For that recovery time period, any files or folders that were unchanged will not display under the renamed directory. Instead, they will be displayed under the old directory name.

In NetWorker 7.5 or greater, you can back up all of the files and folders under a renamed directory regardless of whether or not they have changed. The advantage of this feature is that data under the renamed directory does not appear to be lost when performing a recovery.

Be aware of the following when deciding whether or not to enable this feature:

- ◆ The backup renamed directory feature is enabled on a client basis. Consider enabling this feature only on clients that are prone to issues with recovering renamed directories.
- ◆ Even if no renamed directories are encountered, enabling this feature will increase the backup time for a client.
- ◆ Enabling this feature can further increase the backup time and result in increased media usage, depending on the level at which a renamed directory is encountered. A full backup will be performed on all sub-directories and files under a renamed directory.
- ◆ The enterprise environment and the NetWorker server and client operating system platforms have a large impact on the overhead associated with enabling this feature.

To enable the backup renamed directory feature:

- ◆ Select the Backup renamed directories attribute in the Client resource. [“Editing a client” on page 470](#) provides information about editing a Client resource.

Note: If this option is selected and a renamed directory is at some future date given its original name, files and subdirectories under that directory will not be eligible for backup until the files or subdirectories are updated or the next full backup occurs.

Backing up only client file indexes and the bootstrap

You can set up a backup group to backup only the client file index information for those NetWorker clients that belong to the backup group. The bootstrap will also be backed up.

To backup only the client file indexes and the bootstrap:

1. Set up a backup group as described in [“Task 2: Set up a group for backup clients” on page 57](#)
2. In the backup group properties Advanced tab, select **Index only** from the **Options** attribute.
3. Click **OK**.

This chapter covers these topics:

◆ Devices and libraries.....	98
◆ Storage nodes.....	99
◆ Storage node configuration.....	99
◆ Data Domain deduplication devices.....	104
◆ Avamar deduplication nodes and replication nodes.....	104
◆ Dynamic drive sharing.....	104
◆ Autodetection of libraries and devices.....	110
◆ Add (configure) libraries.....	113
◆ Library reconfiguration.....	117
◆ Add (configure) stand-alone devices.....	118
◆ Support for cloud backup devices.....	120
◆ Deleting libraries and devices.....	125
◆ Library slots.....	126
◆ Troubleshooting autoconfiguration failure.....	126

Devices and libraries

NetWorker software automatically recognizes devices that are being used for backups and recoveries. The maximum number of configured devices for any NetWorker server and storage node combination is 512. The maximum number varies depending on the particular server that is being administered. The maximum number also does not include read-only devices created for advanced file type devices. “[File type \(FTD\) and advanced file type \(AFTD\) devices](#)” on page 242 provides information about file type devices, advanced file type devices, and the NetWorker DiskBackup option.

The NetWorker Console permits extensive handling of devices, including the ability to autoconfigure:

- ◆ SCSI devices
- ◆ NDMP devices
- ◆ Silos

The details that describe a particular device can be viewed, and often changed, in the device’s Properties.

To view details:

1. Select **View > Diagnostic Mode** to see the full range of settings and options available in the **Properties** window.
2. In the **Properties** window, click **Field Help** for a description of the various fields and attributes.

These options are available from many of the menus throughout the **Devices** task:

- ◆ Configure all Libraries
- ◆ Scan for Devices

If these options are started from the server folder instead of from the Storage Node folder, then all storage nodes on the NetWorker server are automatically selected for configuration in the wizard, or for scanning, respectively.

As with other Console functions, users can view and work with only those NetWorker servers for which they have access permission.

Support for LTO-4 hardware-based encryption

The use of LTO-4 hardware-based encryption is supported by NetWorker when controlled by management utilities that are provided with the LTO-4 hardware, or by third-party key management software. EMC does not test or certify these key management utilities; however, the NetWorker application can read from and write to LTO-4 devices that use hardware-based encryption. The use of this encryption is transparent to NetWorker. Neither the encryption nor the key management process is managed by the NetWorker application. This includes the ability to turn encryption on or off within NetWorker, and the management of encryption keys.

Storage nodes

Storage nodes (including the NetWorker server) are host computers with attached storage devices. A storage node has the physical connection and ownership of the attached devices, but the NetWorker server maintains the client file index and media database. With the NetWorker software, client data can be routed directly to a storage node's storage devices without the data first going to the NetWorker server. A storage node may be a client of the NetWorker server, although this is not a requirement. However, the storage node must have the NetWorker client software installed.

From the NetWorker server, typical storage tasks can be performed, such as:

- ◆ Mounting and labeling volumes for the storage node devices.
- ◆ Configuring NetWorker resources associated with the storage nodes.

Only users who have the Configure NetWorker privilege can add to or change the configuration of the NetWorker server, media devices, and libraries. "[NetWorker User Groups](#)" on page 442 provides more information.

Prerequisites

To operate the NetWorker software with storage nodes, the following requirements must be met:

- ◆ On UNIX systems, this software must be installed on the storage nodes. The packages must be installed in the order listed:
 1. NetWorker client software
 2. NetWorker storage node software
 3. (Optional) EMC AlphaStor software.

The AlphaStor software must be used to manage the libraries, drives, and volumes on that node. The AlphaStor server is available on Solaris and Microsoft Windows only. AlphaStor DCP/LCP is available on all UNIX, Linux, and Windows platforms. Refer to the *EMC NetWorker Software Compatibility Guide* for information.
- ◆ On Windows systems, the Storage Node Option must be installed. This installs both the NetWorker client and storage node software.

Licensing

The new for 7.6 Service Pack 1, *NetWorker Licensing Guide* provides information on NetWorker licensing support for storage nodes.

Storage node configuration

After the required software and enabler codes are installed, each storage node device must be configured (by adding them to the NetWorker server). This procedure is similar to the tasks required for other devices. "[Configuring a storage node](#)" on page 100 provides more information.

Configuring a storage node

To configure a NetWorker storage node:

1. In the server's **Administration interface**, click the **Devices** button.
2. Right-click **Storage Nodes** in the navigation tree, and select **New**. The **Create NSR Storage Node** window appears, with the **General** tab shown.
3. In the **Identity** area:
 - a. Type the fully-qualified domain name or short name of the storage node in the **Name** field.
 - b. Check a box (NDMP, SCSI, or silo) in the **Type of Storage Node** field. The default is SCSI.

Note: If NDMP is selected, the remote username and password must be entered. If configuring a silo for use with NDMP, select silo rather than NDMP. Also verify that the silo robot arm is undetected by the NDMP storage nodes.

4. In the **Device Management** area, configure:
 - a. Select a **Device Sharing Mode**. The default is **Server Default**.
 - b. Select whether to search all LUNs (logical unit numbers) targets. Setting this field to **Yes** may cause device detection operations to take a very long time. If **No** is selected, NetWorker stops searching at the first unused LUN. The default is **No**.
 - c. Select whether to use persistent names when performing device discovery and autoconfiguration operations. The default is **No**. [“Persistent binding and naming” on page 270](#) provides more information on the use of persistent device names.
 - d. Name SCSI targets to skip, if any, and if the storage node type is set to SCSI.
 - e. Type only one SCSI target per line.
5. In the **Remote Host** area, type the name of any remote user who is to be allowed to access the remote host from the storage node along with the password for this remote user.

Note: Only one remote user with password is allowed per storage node. This applies to NDMP and advanced file type devices (AFTDs). [“File type \(FTD\) and advanced file type \(AFTD\) devices” on page 242](#) provides more information about AFTDs.

6. Click **OK** when done. The new storage node appears in the navigation tree.

Modifying timeout attribute for storage node operations

An attribute named **Nsrmmd Control Timeout**, which is set during NetWorker server configuration, configures the amount of time a NetWorker server waits for a storage node request to be completed. If the timeout value is reached without completion of the request, the operation stops and an error message is logged. The default value assigned to **Nsrmmd Control Timeout** is five minutes.

Other attributes involved in storage node timeouts include:

- ◆ **Nsrmmd polling interval**, which determines the number of minutes between storage node polls.

- ◆ Nsrmmmd restart interval, which determines the number of the minutes the NetWorker software waits before restarting the nsrmmmd process. A value of zero for the **Nsrmmmd restart interval** attributes indicates an immediate restart.

To modify these attributes:

1. In the server's **Administration interface**, click the **Configuration** button.
2. Select **View>Diagnostic Node**.
3. Right-click the NetWorker server and select **Properties**.
4. Select the **Media** tab.
5. Modify the attributes as appropriate and click **OK**.

Timeouts for storage node remote devices

Timeouts that determine how long to wait for mount requests on a storage node remote device before the save is redirected to another storage node are set in a device's Properties.

The **Storage Node Devices** area of the tab includes these attributes related to storage node timeouts:

- ◆ **Save Mount Timeout**
- ◆ **Save Lockout**

Set the **Save Mount Timeout** and **Save Lockout** attributes to change the timeout of a save mount request on a remote device.

If the mount request is not satisfied within the time frame specified by the **Save Mount Timeout** attribute, the storage node is locked out from receiving saved data for the time specified by the **Save Lockout** attribute.

The default value for **Save Mount Timeout** is 30 minutes. The default value for **Save Lockout** is zero, which means the device in the storage node continues to receive mount requests for the saved data.

Note: The **Save Mount Timeout** applies only to the initial volume of a save request.

To modify these attributes:

1. In the server's **Administration interface**, click the **Devices** button.
2. Select **View>Diagnostic Node**.
3. Right-click the remote device and select **Properties**.
4. Select the **Advanced** tab.
5. Modify the attributes as appropriate and click **OK**.

Storage node affinity

The choice of which NetWorker servers and storage nodes receive a client's data—known as *storage node affinity*—is made by entering their hostnames in the Storage Nodes attribute located in the Client Properties, on the Globals (2 of 2) tab. The default setting for the Storage Nodes attribute on most Client resources is **nsrserverhost** (the host NetWorker server).

If the Client resource of a storage node computer is created after a remote device on the storage node has been created, the default setting of the Storage Nodes attribute is the storage node and the NetWorker server.

If a Client resource is created after a storage node is created, and the client is to back up to that storage node, the name of the storage node must be entered in the client's **Storage Nodes** attribute *above* the default **nsrserverhost**. Storage node names can be added to this list at any time. The client directs its data to the first storage node in the list that has an enabled device and is capable of receiving the data.

To modify the Storage Nodes attribute:

1. In the server's **Administration interface**, click the **Configuration** button.
2. Select **Clients**, right-click the appropriate client and select **Properties**.
3. Select the **Globals (2 of 2)** tab.
4. Modify the **Storage Nodes** attribute as appropriate and click **OK**.

Bootstrap backup on a storage node

When the server's bootstrap save set is backed up, the data writes to a device that is local to the NetWorker server. A bootstrap cannot be backed up to a remote device, but a bootstrap can be cloned or staged to a remote device. When the **mmrecov** command is used to recover a bootstrap save set, the data must be recovered from a local device.

Staging bootstrap backups

Bootstrap backups can be directed to a disk device such as an AFTD or FTD device. However, if a bootstrap backup is staged to another device, the staging operation will complete and will be reported as complete even though the "recover space" operation will not be executed. This means that the staged bootstrap will remain on the original disk from which it was staged. Therefore, the original disk can be used to scan in the bootstrap data if the staged bootstrap is accidentally deleted. Also be aware that if the bootstrap data is not staged from the original disk, the data on the original disk will be subject to the same browse and retention policies as any other saveset backup and will, therefore, be subject to deletion after the retention policy has expired.

This bootstrap information also applies to NDMP devices.

Dedicated storage nodes

In NetWorker release 7.0 and later, all devices created on storage nodes (except servers) include the Dedicated Storage Node attribute. A dedicated storage node can back up only its own, local data.

Set this attribute when a device is created on a remote storage node. It is found in the device's Properties, on the Configuration tab. If the Dedicated Storage Node attribute is set to Yes, a Dedicated Storage Node License is required for the storage node. If, however, the Dedicated Storage Node attribute is set to No (the default value), a standard storage node license is required. The Dedicated Storage Node License also can be used for backing up virtual clients in a cluster.

Note: A storage node host cannot mix storage node types. Either all devices on a storage node must be set up for a dedicated storage node, or all must be set up for a standard storage node.

In NetWorker release 7.6, NetWorker supports the installation of a dedicated storage node in a Solaris 10 local zone to backup directly to a physically attached device without sending data across the IP network. NetWorker allows sharing of a device

between multiple dedicated storage nodes that are installed in multiple local zones of a single physical host, assuming all the storage nodes belong to a single NetWorker data zone.

Tips for troubleshooting storage nodes

If a backup fails, this message might appear:

```
no matching devices; check storage nodes, devices or pools
```

The problem could be related to storage node affinity.

Possible causes include:

- ◆ No enabled devices are on the storage nodes.
- ◆ The devices do not have volumes that match the pool required by the backup request.
- ◆ All devices are set to read-only or are disabled.

For example, if the client has only one storage node in its Storage Node list, and all devices on that storage node are disabled, fix the problem and then restart the backup.

Complete one of the following actions to fix the problem:

- ◆ Enable devices on one of the storage nodes in the client's list.
- ◆ Correct the pool restrictions for the devices in the storage node list.
- ◆ Configure an additional storage node that has enabled devices that meet the pool restrictions.
- ◆ Set one of the devices to read/write.

Data Domain deduplication devices

The *EMC NetWorker Data Domain Devices Integration Guide* provides information about setting up and configuring Data Domain deduplication backup devices.

Avamar deduplication nodes and replication nodes

Deduplication nodes and replication nodes exist on Avamar servers. Contact EMC Customer Support to configure these nodes on the Avamar server side. Once that has been done, you can create access to them from the NetWorker side.

The *NetWorker Avamar Integration Guide* provides information on how to create a NetWorker deduplication node.

Dynamic drive sharing

Dynamic Drive Sharing (DDS) is a feature that provides NetWorker software with the ability to recognize shared drives. DDS enables NetWorker software to do the following:

- ◆ Skip the shared drives that are in use.
- ◆ Route the backups or recoveries to other available shared drives.

Introduction to DDS

DDS controls application requests for media and allows the NetWorker server and all storage nodes to access and share all attached devices.

A system administrator can configure DDS by setting a sharing policy for devices that are accessible from multiple storage nodes.

Two terms central to the use of DDS are *drive* and *device*. Within the context of DDS, these terms are defined as follows:

- ◆ Drive — The physical backup object, such as a tape drive, disk, or file.
- ◆ Device — The access path to the physical drive.

Note: DDS is currently supported only in a storage area network (SAN) Fibre Channel environment and not in a direct-connect SCSI environment.

Benefits of DDS

Enabling DDS on a NetWorker system provides these benefits:

- ◆ Reduces storage costs — A single tape drive can be shared among several storage nodes. In fact, since NetWorker software uses the same open tape format for UNIX, Windows, NetWare and Linux, the same tape can be shared between different platforms (assuming that respective save sets belong to the same pool).
- ◆ Reduces LAN traffic — Clients can be configured as SAN storage nodes that can send save sets over the SAN to shared drives.
- ◆ Provides fault tolerance — Within a SAN environment, hardware can be configured to eliminate a single point of failure.
- ◆ Provides configuration over a greater distance — Allows configuration of a system over a greater distance than with SCSI connections.

DDS configuration overview

Figure 9 on page 105 illustrates the DDS process and potential configurations for sharing drives. This basic configuration consists of a server, two storage nodes, and a library with two tape drives.

In this figure:

- ◆ Storage nodes sn_1 and sn_2 are attached to the library.
- ◆ Each node, on its own, has access to drive_1 and drive_2.
- ◆ With DDS enabled, both nodes have access to both drives and can recognize when a shared drive is in use.
- ◆ Under such a configuration, two DDS licenses are required, one for each drive.

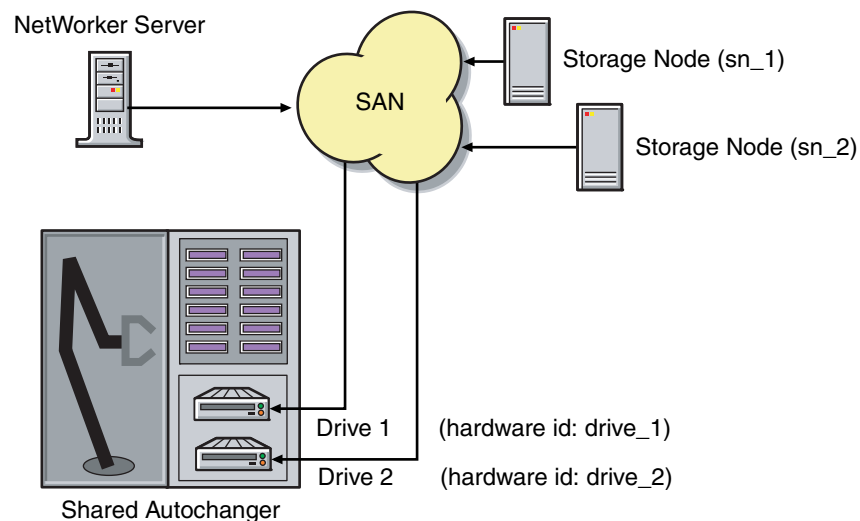

Figure 9 Dynamic Drive Sharing

Note: Ensure that all applicable devices can be seen from each storage node by running the `inquire -l` command locally on each storage node.

Block-size compatibility

With DDS enabled, drives can be shared between storage nodes on different platforms, such as UNIX and Microsoft Windows. For NetWorker software operations (such as backups and recoveries) to take place successfully, ensure that the block size is compatible between different platforms and/or hardware.

To ensure compatibility, make sure one of the following conditions is met:

- ◆ The various storage nodes sharing a drive support the same block sizes.
- ◆ When a tape is labeled on a drive, it is labeled with the block size defined on the storage nodes.

“Compatible block size for UNIX and Windows” on page 261 provides information about how to set block sizes for individual drives or tapes on different platforms.

Block-size incompatibility between UNIX and Windows

Incompatible block-size settings between UNIX and Microsoft Windows storage nodes could result in any of these error scenarios:

- ◆ A backup taken on a UNIX node might not be recoverable on a Microsoft Windows node if the Windows node does not support large block sizes.
- ◆ A UNIX process labels and saves data to a tape and leaves the tape mounted. A Microsoft Windows process subsequently attempts to verify the label on this tape and fails because the label verification is done by reading a header from the data portion.
- ◆ A tape on a UNIX node is labeled with a large block size. The backup is started on a Microsoft Windows node and the Windows node attempts to write the backup by using the default block size. Internally, the backup on Windows is written by breaking down the big buffer of data into smaller segments of writable block sizes.

Attempting to recover a specific file on Windows in this situation fails due to positioning errors on the tape. The data is still recoverable from the Windows side, since the NetWorker software will switch from using file and block positioning to reading the tape from the beginning to reach the correct position. The data might not, however, be recoverable from the UNIX side.

SCSI Reserve/Release

The Reserve/Release attribute has been added to the Device resource for tape devices to support Reserve/Release, including the Persistent Reserve commands.

Reserve/Release is a mechanism that uses SCSI commands to attempt to prevent unintended access to tape drives that are connected by using a shared-access technology, such as Fibre Channel, iSCSI, or SCSI multiplexers. It is a "cooperative" and host-based mechanism, which means that all applications should respect the reservations and not purposely break them. Access is granted based on the host system that reserved the device. Other applications that run on that host cannot be prevented from accessing a reserved device.

Reserve/Release cannot prevent a malicious or badly behaved application from accessing a reserved device. It also cannot prevent all problems caused by hardware issues (such as SCSI resets or FC LIPs) from interrupting data access.

The basic sequence requires that a host reserve a tape drive (using specific SCSI commands) before attempting to access the tape drive. If this "reservation" succeeds, then the host can use the drive. If the reservation fails (usually because the device is reserved by someone else), then the host attempting the reservation should not attempt to use the drive. When a host has finished using a reserved drive, that host must release the drive by using the appropriate SCSI commands.

The reservation is maintained by the drive itself. With older (called "Simple" in NetWorker software) Reserve/Release, the reservation is based on the SCSI ID of the system that issued the reserve command. For tape drives connected to Fibre Channel (FC) using FC-SCSI bridges, the mapping between FC host and reservation is done inside the bridge, since the initiator on the SCSI side is always the bridge itself, regardless which host actually issued the reserve command.

For Persistent Reserve, the reservation is associated with a 64-bit "key" that is registered by the host. Several keys can be registered with a given drive at any given time, but only one may hold the active reservation. NetWorker software uses the "exclusive" reservation method for Persistent Reserve. Only the host that holds the active reservation is allowed to access the drive.

The Reserve/Release attribute does not support file type or advanced file type devices.

The settings that relate to Reserve/Release and Persistent Reserve are found in a device's Properties window, on the Advanced tab. They are visible only when diagnostic mode is turned on.

The default setting for Reserve/Release is None. Once any other Reserve/Release setting is selected, it works automatically, without further user intervention. The Reserve/Release attribute is supported only on Common Device Interface (CDI) platforms, so if the CDI attribute in a device's Properties is set to Not Used, then Reserve/Release settings are ignored. ["Common device interface" on page 268](#) provides more information regarding CDI.

For newer hardware, once a Reserve/Release setting (other than None) has been selected, the appropriate Persistent Reserve commands are automatically issued before a device is opened for reading or writing, and before the device is closed. With older hardware, a SCSI-2 Reserve command is issued before opening the device, and a SCSI-2 Release command is issued after the device is closed.

Reserve/Release has these possible settings:

- ◆ None (the default)
- ◆ Simple
- ◆ Persistent Reserve
- ◆ Persistent Reserve + APTPL (Activate Persist Through Power Loss)

The Persistent Reserve Key attribute has also been added. It is used with Persistent Reservation calls.

Restrictions for use of the SCSI Reserve/Release setting

Note these restrictions for this feature:

- ◆ It is available on CDI platforms only. Consequently, since CDI is not supported within an NDMP environment, Reserve/Release is not supported with NDMP. It is also not supported on IRIX and SGI platforms.
- ◆ Not all drives support persistent Reserve/Release. (All drives support at least simple reserve release. The code automatically drops back from Persistent +APTPL or Persistent to Simple on drives that do not support Persistent.)
- ◆ SCSI resets can clear Simple reservations at the device.
- ◆ Even with Reserve/Release, there is no guarantee against data loss.
- ◆ If the operating system has its own Reserve/Release feature, that feature must be disabled in order for the NetWorker Reserve/Release feature to work.
- ◆ Even if all of the enterprise's NetWorker storage nodes have this feature enabled, then it is possible that, on the storage node where a backup operation is run, data loss can be caused by the operating system's utilities or by third-party programs.

Enabling DDS with NDMP

These sections explain the requirements for successfully enabling DDS with NDMP.

DDS on NDMP nodes in a SAN environment

Drives can be shared between NDMP nodes in a SAN environment. Ensure, however, that the NDMP nodes are homogeneous.

For example, DDS can be enabled in these configurations:

- ◆ EMC Celerra® to EMC Celerra
- ◆ EMC IP4700 to EMC IP4700
- ◆ NetApp to NetApp (any NetApp nodes that Network Appliance supports within a zone)

The current NDMP implementation does not allow the sharing of drives between non-homogeneous NDMP nodes. There is, however, no inherent limitation within DDS that would prevent this.

Figure 10 on page 108 illustrates a basic DDS configuration with NDMP.

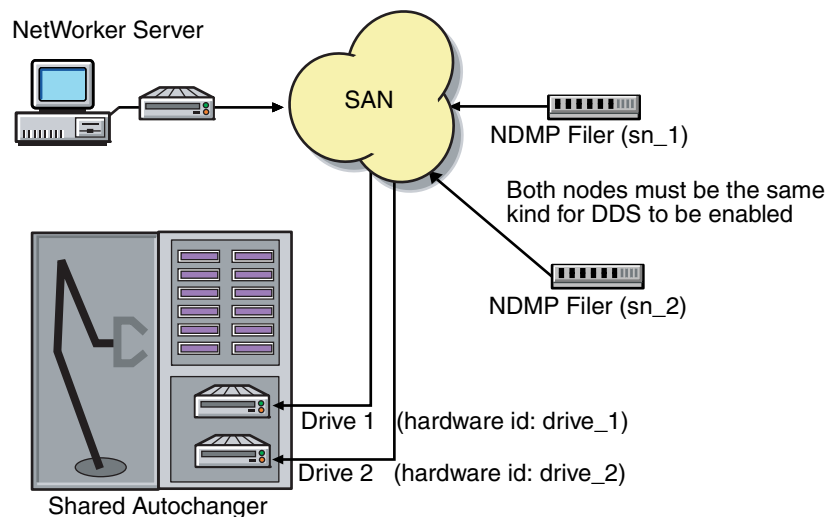

Figure 10 DDS with NDMP

DDS attributes in the device properties

Attributes used in DDS are found in the Properties window for a device:

- ◆ Hardware ID
- ◆ Shared Devices

Hardware ID attribute

The Hardware ID attribute tracks the drives that are being shared by multiple hosts. Device instances sharing the same physical drive across multiple hosts have the same hardware ID. The hardware ID is automatically assigned during the device autoconfiguration process, or it can be added when manually configuring a device. It is not editable by users.

The hardware ID can be viewed in the Properties window for a device, on the General tab, in the Device Sharing area.

The hardware ID is generated when a device is scanned or configured. The hardware ID consists of the following:

- ◆ The hardware serial number
- ◆ The device type
- ◆ The worldwide part number (WWPN)
- ◆ The worldwide name (WWN)

Do not try to change a hardware ID once it has been generated. It is read-only.

Shared Devices attribute

The Shared Devices attribute appears on the Operations tab of a device's Properties when in diagnostic mode. It features values that can be used to manipulate all shared instances of a drive at the same time. This attribute enables or disables all devices that share the same hardware ID with a single action. [Table 12 on page 109](#) lists this attribute's allowed values and their descriptions.

Table 12 Shared Devices attributes

Value	Description
Enable All	When selected, enables all devices by using the same hardware ID.
Disable All	When selected, disables all the devices by using the same hardware ID.
Done	This is the default setting. After the server has enabled or disabled all devices with the same hardware ID, the attribute is reset to Done.

The Shared Devices attribute is not reflected in the `jbconfig` program.

Idle Device Timeout attribute and DDS

A tape might remain mounted in its drive after a backup has completed. Other requests for the drive from another device path must wait during this timeout period. The timeout value can be adjusted by changing the Idle Device Timeout attribute.

The Idle Device Timeout is not specifically a DDS attribute, but it can be useful in configuring shared drives. This attribute appears on the Advanced tab of a device's Properties when in diagnostic mode. The default value is 0 (zero) minutes. Select a time that is appropriate for the system configuration.

Note: Selection of zero means that the device never times out and the tape must be ejected manually.

High availability and DDS

The NetWorker software relocates and restarts operations that were in progress when a failure occurs on a cluster node. Currently, savegroups are the only highly available operations.

The nsrjb program high availability limitations

If the NetWorker server fails over from one node to a new target node, standard library operations (such as performing an inventory, labeling, mounting, or unmounting a volume) do not automatically restart on the new target node.

Example 5 Host crash requires user intervention

This example scenario includes: two physical hosts, A and B, with DDS enabled, sharing the drives on a library.

Physical host A mounts a tape in a shared drive on the library. If physical host A subsequently crashes, the volume is held in that shared drive until the reset command `nsrjb -H` is issued (from host B, in this example) along with a reset from the Library Operations Windows in the NetWorker Console.

This command unloads the drive and makes it available for future backups. The reset command clears the drive by accessing the device through another shared path. In this example, the other shared path would be on host B.

Successfully unloading a volume requires that the NetWorker software be able to access the same path through which the volume was initially loaded.

Licensing

The new for 7.6 Service Pack 1, NetWorker *Licensing Guide* provides information about NetWorker licensing support for DDTS.

Autodetection of libraries and devices

This section provides information on scanning for libraries and devices.

Scanning for libraries and devices

Devices already known to the NetWorker server can be seen in the enterprise hierarchy in the navigation tree. Use the **Scan for Devices** option described here to find devices that are not yet known to the NetWorker server. Be aware that:

- ◆ A storage node must be added to the hierarchy before its devices can be scanned.
- ◆ The **Scan for Devices** option does not detect file type or advanced file type devices.
- ◆ A specific network interface can be used between the NetWorker server and the storage node when scanning for devices. [“Identifying a specific network interface for device scan operations” on page 111](#) provides more information.

To scan for available devices:

1. In the **Console** window, click **Enterprise**.
2. In the navigation tree, select a NetWorker server.
3. In the **Name** column of the **Host detail** table, double-click **NetWorker**. The **NetWorker Administration** window for the selected server opens. Note that while multiple **NetWorker Administration** windows can be open simultaneously, each one displays information about only one host or server.
4. In the **Administration** window, click **Devices**.
5. In the navigation tree:
 - a. Right-click the server name, and select **Scan for Devices**.
 - b. Click the storage node to be scanned.
 - c. If the appropriate storage node is not listed, click **Create a New Storage Node**.

- d. When creating a new storage node, replace the default value in the **Name** field with the fully-qualified domain name or short name of the new storage node.
 - e. Fill in any required information, such as whether to scan for SCSI or NDMP devices and whether to search all LUNs.
 - f. Click **Start Scan**. To monitor the scan activity, click **Monitoring**, then select the **Log** tab. Any relevant status information is displayed there.
6. Return to the **Devices** navigation tree to view the refreshed device information (configured and unconfigured):
 - To display SCSI and NDMP libraries available to the NetWorker server, select **Libraries** in the navigation tree. Any available library or silo appears in the Libraries detail table.
 - To display stand-alone devices available to the NetWorker server, select **Devices** in the navigation tree. Any available stand-alone device appears in the **Devices** detail table, along with devices available in libraries.
 - To display the libraries and devices that are available to a storage node, select the storage node in the navigation tree. Available storage nodes appear in the table. Double-click a storage node to see its details, along with the devices that are available in the storage node.

Note: Autodetection should not be used for devices on a Storage Area Network (SAN) while any of the devices are in use, because this may cause the device in use to become unresponsive. To avoid this situation, do not configure a device in multiple NetWorker datazones.

Identifying a specific network interface for device scan operations

If the NetWorker server has multiple network interfaces, you can specify that a specific network interface be used for scan operations. In this case, the **dvdetect** (device scan) program will use the specified network address or hostname to communicate with the NetWorker server.

To specify a specific network interface for device scan operations:

1. In the server's **Administration interface**, click the **Devices** button.
2. Select **View > Diagnostic Mode**.
3. In the left pane, click on the **Storage Nodes** folder.
4. In the right pane, select a storage node.
5. Right-click the storage node and select **Properties**.
6. Select the **Configuration** tab.
7. In the **Server network interface** field, type the network address or the unique hostname of the network interface on the NetWorker server that is to be used.
8. Click **OK**.

[“Server Network Interface attribute” on page 279](#) provides information on similar attributes that are available for other library and device operations.

Configuring the Sun StorEdge Network Foundation HBA/Driver

This section applies only to storage nodes that run Solaris 9 or earlier. The StorEdge Network Foundation host bus adapter (HBA) requires a special configuration to bind the device World Wide Port Names that are used by the EMC logical unit specification (lus) driver.

The `/usr/sbin/lus_add_fp_devs` script adds the proper entries to the `lus.conf` files. Before the script is run, however, ensure that all devices are powered on and connected to the HBAs.

Note: The `/usr/sbin/lus_add_fp_devs` script should be used only to configure libraries over Fibre Channel.

These are examples of additional entries for the `/usr/kernel/drv/lus.conf` script:

```
name="lus" parent="fp" target=0 lun=0 fc-port-wwn="22000090a50001c8";
name="lus" parent="fp" target=2 lun=0 fc-port-wwn="22000090a50001c8";
```

Note: Each time a new device is added, or an old device is removed, the new `lus` configuration must be re-created and reinstalled. [“How to add a library device” on page 114](#) provides information about how to add or delete a device. When the `/usr/sbin/lus_add_fp_devs` script runs, check whether the World Wide Port Names appear in the script output. If none appears, the Fibre Channel might be configured incorrectly. Check the configuration by using the Sun `luxadm` program.

Sample `/usr/sbin/lus_add_fp_devs` script output

This is an example of `/usr/sbin/lus_add_fp_devs` script output:

```
# /usr/sbin/lus_add_fp_devs
Updating /usr/kernel/drv/lus.conf
Found StorEdge HBA device:
  /devices/pci@1f,0/pci@1/pci@1/pci@f/SUNW,qlc@4/fp@0,0:devctl1
Found StorEdge HBA device:
  /devices/pci@1f,0/pci@1/pci@1/pci@f/SUNW,qlc@5/fp@0,0:devctl1
Mapping tape devices starting at target 0
  Adding:
    port WWN: 500104f000428e48 as SCSI target 0
    port WWN: 500104f000428e49 as SCSI target 1
    port WWN: 500104f000428f44 as SCSI target 2
    port WWN: 500104f000428f45 as SCSI target 3
Mapping tape devices starting at target 4
  Adding:
    port WWN: 500104f000428e48 as SCSI target 4
    port WWN: 500104f000428e49 as SCSI target 5
    port WWN: 500104f000428f44 as SCSI target 6
    port WWN: 500104f000428f45 as SCSI target 7
Adding medium changer devices starting at target 100
  Adding:
    port WWN: 100000e002000000 as SCSI target 100
    port WWN: 100000e00201105a as SCSI target 101
Adding medium changer devices starting at target 102
  Adding:
    port WWN: 100000e002000000 as SCSI target 102
    port WWN: 100000e00201105a as SCSI target 103
The changes made to lus.conf will not take effect until lus is
reloaded.
If you are sure that no process is currently using lus to control a
tape
library, then it may be safely unloaded.
```

Note: If `lus` is not currently loaded, proceed to the section in the script stating that `lus` is not currently loaded.

```
Would you like to unload lus? (y/n)  y
```

Note: If no is selected, this output appears and the program exits:

lus is currently loaded! It must be unloaded and reloaded for any changes to lus.conf to take effect

Note: If lus is not currently loaded, respond to this prompt:

```
lus is not currently loaded
Would you like to run inquire? (this will cause lus to be loaded using
the newly modified lus.conf) (y/n) y
```

Note: If no is selected at the previous prompt, the program exits.

```
scsidev@0.0.0:FUJITSU MAJ3182M SUN18G 0804|Disk, /dev/rdisk/c0t0d0s2
scsidev@2.0.0:STK 9840 1.28|Tape, /dev/rmt/0cbn
scsidev@2.1.0:STK 9840 1.28|Tape, /dev/rmt/2cbn
scsidev@2.100.0:ADIC Scalar DLT 448 0114|Autochanger (Jukebox)
scsidev@2.101.0:ADIC Scalar DLT 448 0114|Autochanger (Jukebox)
scsidev@3.0.0:STK 9840 1.28|Tape/dev/rmt/6cbn
scsidev@3.1.0:STK 9840 1.28|Tape, /dev/rmt/8cbn
```

Add (configure) libraries

A device resource must be created for each library device, including silos, on a storage node. Because a NetWorker server is also a storage node, this procedure applies to a server and all its storage nodes. Users can choose between configuring libraries automatically through use of a configuration wizard, or configuring them manually and individually in the user interface.

Storage nodes must be created before devices can be configured to be used by them. [“Storage nodes” on page 99](#) provides information about storage nodes and how to create them. Note that all scanning for devices is done at the storage node level, and can be done across multiple storage nodes.

Only devices that have serial numbers can be autoconfigured. Use the **jbconfig** command to configure devices that do not have serial numbers (the **inquire** or **sn** commands can be used to determine if a device returns a serial number).

Devices must be updated to the most recent firmware and drivers.

These device types can be configured automatically:

- ◆ NDMP
- ◆ SCSI
- ◆ Silo (except DAS silo)

Note: On Microsoft Windows systems, Removable Storage Manager (RSM) should be disabled prior to configuring a SCSI-attached library.

These device types must be configured by using the **jbconfig** command:

- ◆ AlphaStor devices.
- ◆ DAS silo
- ◆ Devices managed by Microsoft Removable Storage.
- ◆ IBM tape libraries controlled through the use of IBM’s tape driver. (This is because the device autodetection code uses the internal lus driver to control libraries.)

- ◆ Any library that does not return a serial number for the robotic arm or any of its tape devices.

How to add a library device

To configure a new library resource to a storage node automatically:

1. In the server's **Administration** interface, click **Devices**.
2. Open the **Storage Nodes** folder in the navigation tree.
3. Right-click the storage node to which the device is to be configured, and select **Configure All Libraries** (which is available from many of the menus throughout the **Devices** task). This opens a wizard that can configure all detected libraries, except those explicitly excluded in the library exclusion list during configuration.

Note: If **Configure All Libraries** is started from the server folder instead of from the **Storage Node** folder, then all storage nodes on the NetWorker server are automatically selected for configuration in the wizard.

The **Configure All Libraries** wizard appears. This lets you step through library configuration, including this input (some of which is filled in by default):

- Library type (select SCSI/NDMP).
 - An NDMP remote username and a password are required for an NDMP device that acts as a storage node.
 - Adjust the **Enable New Device** option, if necessary.
 - Current server sharing policy. Use maximal sharing with Dynamic Drive Sharing (DDS). By default, the sharing policy is displayed as "server default," which is maximal sharing.
 - Storage nodes to which libraries can be configured (select a storage node to see its details). If the appropriate storage node is not listed, click **Create a New Storage Node**.
 - When creating a new storage node, replace the default value in the **Name** field with the fully-qualified domain name or short name of the new storage node.
 - Update storage node properties, if required.
4. Click **Start Configuration** after filling in the requested information. The configuration window displays a message that the Configure All Libraries process has started, and that the configuration activity can be viewed by checking the **Monitoring > Log** screen for status.
 5. Click **Finish** on the configuration window to close the configuration wizard. If problems occur during configuration, then the **Back** button on the configuration window becomes active, which allows the user to return to the input screen to adjust input.

How to add a silo device

To configure a new silo resource to a storage node automatically:

1. In the server's **Administration interface**, click **Devices**.
2. Open the **Storage Nodes** folder in the navigation tree.

3. Right-click the storage node to which the device is to be configured, and select **Configure All Libraries** (which is available from many of the menus throughout the Devices task). This opens a wizard that can configure all detected libraries, except those explicitly excluded in the library exclusion list during configuration.

Note: If **Configure All Libraries** is started from the server folder instead of from the **Storage Node** folder, then all storage nodes on the NetWorker server are automatically selected for configuration in the wizard.

The **Configure All Libraries** wizard appears, and allows the user to step through library configuration, including this input (some of which is filled in by default):

- Library type (select **STL Silo**).
- Adjust the **Enable New Device** option, if necessary.
- Current server sharing policy. (Use maximal sharing with Dynamic Drive Sharing (DDS).)
- Storage nodes on which the libraries should be configured. You can select a storage node to see its details displayed; if the appropriate storage node is not listed, click **Create a New Storage Node**.

When creating a new storage node, replace the default value in the **Name** field with the name of the new storage node:

- a. Update storage node properties if required.
 - b. Enter the **Silo Controller** count, which sets the number of silos to be configured for the selected storage node. The default is 1. If a silo count of greater than one is selected, then a library name and hostname must be entered for each one.
 - c. Enter the **Hostname** of the silo controller.
 - d. Enter the **Type of silo** controller. The default is ACSLS Silo (StorageTek).
 - e. If a DAS silo controller was chosen, enter the DAS client name (which should match the storage node name).
 - f. (Optional) Use the **Test Silo Controller Connectivity** button to see whether the connection to a silo controller works. Use it once for each silo. An error message appears if the connection to a given silo fails.
4. Click **Start Configuration** after filling in the requested information. The configuration window displays a message that the Configure All Libraries process has started, and that the configuration activity can be viewed by checking the **Monitoring > Log** screen for status.
 5. Click **Finish** on the **Configuration** window to close the configuration wizard. If problems occur during configuration, then the **Back** button on the **Configuration** window becomes active, which allows the user to return to the input screen to adjust input.

Using NetWorker software with ACSLS silos

Note: In this section, the term "ACSLs server" refers to the name of the system that is running any one of StorageTek's library manager programs.

The **ssi** program is used indirectly by the **nsrjb** program to communicate with an ACSLS server. The **nsrjb** program loads **libstlstk**, which handles the TCP calls to and from the **ssi** program. The **ssi** program then handles all of communication to and from the ACSLS server. Starting with ACSLS version 5.3, it is possible to run either a NetWorker server or storage node on the same host that is running ACSLS.

To configure a library, the **ssi** and **mini_el** programs must be running on the system on which library configuration is performed. The **ssi** and **mini_el** programs are generally run as background processes, and are usually started automatically by the system.

In addition to the **ssi** and **mini_el** programs, a shared library file (usually called **libstlstk.xxx** where **xxx** is an operating system-dependent extension) is also required. An appropriate version of this library is installed as part of NetWorker installation.

ACSLs silos and firewalls

With **ssi** version 2.0, communication with the ACSLS server on a specified port number is supported, using the **-a** command line option. This is part of the STK firewall enhancement. The ACSLS version 7 must be running on the ACSLS server to use this functionality.

The UNIX man pages for these commands, or see the *NetWorker Command Reference Guide* provides information on the **ssi** and **mini_el** programs.

Queuing device resources for AlphaStor

Because the NetWorker software detects devices as virtual devices, users can request more devices than actually exist. The AlphaStor software queues these requests, and can prioritize them according to whether a tape is mounted for reading, or for writing. This allows AlphaStor users to prioritize recovery operations above backups or other operations that might compete for the same devices.

This feature requires AlphaStor release 3.1 or later.

Configure the AlphaStor library with the **jbconfig** command. For information about configuring resource queuing, refer to the *EMC AlphaStor Administration and Operator's Guide*. The **nsr_mount_request** man page describes the resource-queuing feature. Related attributes are also in the **nsr_pool** and **nsr_jbox** UNIX man pages and the *NetWorker Command Reference Guide*.

Virtual Tape Library (VTL) configuration

During library configuration, the NetWorker software automatically detects that a library is a VTL, and updates the read-only Virtual Jukebox attribute to Yes. If the NetWorker software determines that the library being configured is not a VTL, it sets the Virtual Jukebox attribute to No.

Licensing

The new for 7.6 Service Pack 1, *NetWorker Licensing Guide* provides information about NetWorker licensing support for a Virtual Tape Library.

Library reconfiguration

Users with Configure NetWorker privileges can reconfigure a library in order to add or remove access paths to the drives in a library. This includes access paths that allow libraries to be shared.

Be aware of the following considerations when reconfiguring a library:

- ◆ The reconfiguring of stand-alone or file type devices is not supported. Instead, delete the stand-alone or file type device, and then create a new one.
- ◆ The reconfigure library feature described in [“Reconfiguring a library”](#) does not support adding NDMP drives to a non-NDMP library if both the NDMP server and the NetWorker storage node are on the same host. Instead, use the `jbedit` command, which is described in [“Using the jbedit command”](#) on page 117.

Reconfiguring a library

To reconfigure a library:

1. Run **Scan for Devices**, in case a device path has been added to, or removed from, the library since the latest scan.
2. In the server’s **Administration** window, click **Devices**.
3. Select **Libraries** in the navigation tree. The **Libraries detail** table appears.
4. In the navigation tree, right-click the entry for the library to be reconfigured, or open the **Storage Nodes** folder, open the library folder, and then right-click the library entry there.
5. Select **Reconfigure Library**. The **Reconfigure Library** window appears. Note that the storage node name and library name cannot be changed in this window.
6. Make appropriate changes in the **Configure devices on various storage nodes using existing drive connectivity** area, selecting or clearing checkboxes as necessary, or using the buttons at the right side of the area (**Check All**, **Clear All**, **Reset**).

Drives that are already configured to be used by the library display check marks in the boxes adjacent to their names:

- Selecting a box adds the drive to the library.
 - Clearing a box removes the drive from the library.
 - The **Reset** button returns the checkboxes to the condition they had when the Reconfigure Library window was opened.
7. Click **Start Configuration** to reconfigure, or **Cancel** to leave the window.
 8. Run **Scan for Devices** to refresh the navigation tree and show the reconfiguration results.

Using the jbedit command

The `jbedit` program can be used as a fallback means of editing library configurations if, for some reason, the autoconfiguration program is not working. The command can be run on a NetWorker server, storage node, or client (if the client is a storage node). It works without disrupting any backup or recovery operations on the library.

The `jbedit` program supports all direct-attached SCSI/SJI, SAN, and NDMP libraries. It does not currently support AlphaStor libraries.

The **jbedit** program is not intended to be a full-fledged editor of the Library resource. The editing of Library resource attributes should be done as described in “[Library reconfiguration](#)” on page 117. The **jbedit** options provide selection lists that make it easy to find drives or devices to be added or deleted.

Note: Running the **jbedit** program requires Configure NetWorker privileges.

[Table 13 on page 118](#) lists the most commonly used **jbedit** program options.

Table 13 Common jbedit options

Option	Description
-a	Add a drive or device.
-d	Deletes a drive or device.
-j	Name of the autochanger to be edited.
-f	Name of the device to be added or deleted.
-E	Element address of the device to be added or deleted.

The *EMC NetWorker Command Reference Guide* or the UNIX man page provides a detailed description of the **jbedit** command, its options, and associated diagnostic messages.

Add (configure) stand-alone devices

A Device resource must be created for each stand-alone device on a storage node. Stand-alone drives must be configured individually.

Storage nodes must have been created before devices can be configured to be used by them. “[Storage nodes](#)” on page 99 provides information about storage nodes and how to create them. Note that all scanning for devices is done at the storage node level, and can be done across multiple storage nodes. Only devices that have serial numbers can be autoconfigured. Use the **jbconfig** command to configure devices that do not have serial numbers.

Note: Devices must be updated to the most recent firmware and drivers.

Autodetecting and configuring a stand-alone tape drive

To configure a new stand-alone tape drive, automatically, by using Scan for Devices:

1. In the server’s **NetWorker Administration interface**, click **Devices**.
2. Right-click **Devices** in the navigation tree, and select **Scan for Devices** to detect available devices. The **Scan for Devices** window appears.
3. Click **Start Scan**.
4. Check the scan status by clicking the **Monitoring** button and selecting the **Log** tab. Then return to the Devices navigation tree.
5. Select either the **Devices** folder or the **Storage Nodes** folder in the navigation tree. All detected drives are listed. Any still-unconfigured drives are preceded by a circular icon that displays a wrench.

6. Right-click the stand-alone drive to be configured, and select **Configure Drive**. A **Configuration** dialog box appears.
7. Click **Yes** to confirm that the drive should be configured. The new drive is automatically configured.

Adding a stand-alone device manually

To configure (add) a new stand-alone device on a storage node:

1. In the server's **NetWorker Administration** interface, click **Devices**.
2. Right-click **Devices** in the navigation tree, and select **New**. The **Create Device** window appears, with the **General** tab selected, and a default device path in the **Name** field of the **Identity** area of the window.
3. Replace the default name with the path and name of the device:
 - a. If the device is configured on the server's storage node, the name is the simple device path, such as `/tmp/d0` for a file type device. A tape device on Microsoft Windows would have a format similar to `\\.\Tape0`.
 - b. If the device is configured on a remote storage node, however, then the name must indicate that the storage node is remote, by including `rd=` and the name of the remote storage node in the device path. For example, if the remote storage node is `neptune`, then the device path might be `rd=neptune:/tmp/d0` or `.rd=neptune:\\.\Tape0`.
4. In the **Identity** area, configure:
 - a. In the **Comment** field add an optional, descriptive comment.
 - b. In the **Media Type** field, select a media type.
5. In the **Status** area, configure the applicable checkboxes:
 - **Read Only**
 - **Auto Media Management**
6. In the **Cleaning** area, configure the applicable fields:
 - **Cleaning Required**
 - **Cleaning Interval**

The **Date Last Cleaned** is filled in automatically once a drive has been cleaned.
7. Select the **Configuration** tab to set attributes, such as:
 - Target Sessions
 - Max Sessions
 - Local Backup to a dedicated storage node

NDMP settings (NDMP remote username and password are required for an NDMP device that acts as a storage node.)
8. Click **OK** when the configuration is complete.

[“File type \(FTD\) and advanced file type \(AFTD\) devices” on page 242](#) provides instructions and restrictions on backing up to a file type device.

Configuring NetWorker DiskBackup

The NetWorker DiskBackup solution greatly reduces the time to save and recover data when compared to the use of tape. NetWorker DiskBackup enables data to be saved to a computer's local or network-attached disk, rather than by using a tape device to write the data to storage media.

NetWorker software offers two variations of this method:

- ◆ File Type Device (local only)
- ◆ Advanced File Type Device (can be a networked drive)

"File type (FTD) and advanced file type (AFTD) devices" on page 242 provides information about the NetWorker DiskBackup solution.

Support for cloud backup devices

This section describes how to configure the NetWorker Cloud Backup Option (NCBO) to perform backup, staging, cloning, and recovery operations to cloud configurations. Backups to cloud occur over a TCP/IP network and can be compressed and encrypted. NetWorker supports EMC Atmos-based cloud storage. More information on Atmos is available at www.EMC.com.

Cloud backup devices compared to other device types

NetWorker backup, staging, cloning, and recovery to cloud storage devices are similar to those operations that are performed with conventional devices. However, cloud devices also have unique features.

Table 14 on page 120 lists the major similarities with other backup device types as well as the unique features of a cloud storage device.

Table 14 A comparison of cloud devices to other device types

Feature	Cloud backup device	AFTD device	Tape device
Same volume mounted simultaneously on multiple devices	Yes	No	No
Staging source	No	Yes	No
Staging destination	Yes	Yes	Yes
Cloning	Yes	Yes	Yes
Auto mount and unmount	Yes	No	Yes *
Data transformation engine (enables encryption and compression on storage node)	Yes	No **	No **
* When the tape is controlled by a tape library. ** Encryption and compression can still be enabled through NetWorker client side directives.			

Cloud backup prerequisites and considerations

The following conditions must be met before you can backup to the cloud:

- ◆ The NetWorker Cloud Backup Option must be licensed and enabled. The new for 7.6 Service Pack 1, NetWorker *Licensing Guide* provides information about entering licence enablers.
- ◆ The NetWorker Cloud Backup Option is supported on Windows and Linux storage nodes only.
- ◆ An Atmos cloud account is set up and you have a username and password to access the cloud account. The *EMC Atmos Installation Guide* and the *EMC Atmos System Management GUI Guide* provides information about setting up and managing an Atmos account.
- ◆ If the Atmos server and the NetWorker server are separated by a firewall, TCP ports 80 and 443 must be open to allow outgoing communication from the NetWorker server to the Atmos server. If a proxy server is configured in the environment, a firewall exception may also need to be created to ensure unrestricted access. If these ports are not open, device operations will fail with the following error:

```
Atmos label operation failed: Failed to write cloud label: Couldn't
connect to server.
```

Be aware of the following considerations with respect to cloud support:

- ◆ NetWorker Avamar deduplication storage nodes do not support cloud backups.
- ◆ For NDMP, only a Data Server Agent (DSA) is supported for cloud backups.
- ◆ NetWorker versions prior to 7.6 do not support cloud backups.

Cloud best practices

Consider the topics and recommendations in this section before implementing cloud backups. For additional best practices information, refer to the *Best Practices for Cloud Backup with NetWorker Fast Start* document, which is available in the NetWorker Whitepapers and Technical Notes section on EMC Powerlink.

Directing NetWorker client backups to a cloud storage device

You direct client backups to a cloud storage device using media pools, in the same way you would direct any other client backup to a device or set of devices. However, be aware of the following recommendations:

- ◆ Set up a media pool for cloud storage devices and give the pool a unique label template.
- ◆ Do not mix cloud backup devices with other types of backup devices in a media pool. [“Sorting Backup Data” on page 183](#) provides information about setting up media pools.

Concurrent backup and recovery operations

A single cloud volume can be mounted on multiple cloud storage devices to support concurrent backup and recovery operations. For example, to optimize performance you could mount cloud volume A on three cloud storage devices: one for backup (device CL1), one for recovery (device CL2), and one for clone operations (device CL3). There is no limit to the number of cloud storage devices that can be mounted on a single cloud volume. Consider such an approach to optimize backup and recovery performance.

Network dependencies

Cloud backups are highly dependent on the network connection that is used to access the cloud service. Any disruption in connectivity or a slowdown in network access speed may adversely affect cloud backups or recoveries.

Creating and labeling a cloud storage device

This section contains the following topics:

- ◆ [“Create the cloud storage device” on page 122](#)
- ◆ [“Label and mount the cloud storage device” on page 124](#)

Create the cloud storage device

To create a cloud storage device:

1. In the server’s **NetWorker Administration** interface, click **Devices**.
2. Right-click **Devices** in the navigation tree, and select **New**. The **Create Device** window appears, with the **General** tab selected, and a default device path in the **Name** field of the **Identity** area of the window.
3. In the **Name** field, replace the default name with a name that uniquely identifies the cloud storage device. If the device is configured on a remote storage node, indicate that the storage node is remote, by including **rd=hostname:** in the name. For example, if the remote storage node is *neptune*, then the device path might be **rd=neptune:cloud1**.

Note: Unlike other devices, a cloud storage device name does not specify a path to the device. You can use any combination of alphanumeric characters for the device name.

4. In the **Comment** field and the **Description** field, add an optional comment and description, respectively.
5. In the **Media Type** field, select Atmos COS as the device type if you are using Atmos as the cloud server.
6. In the **Remote User** field, type the username that is used to access the cloud server. For an Atmos COS device, this is the *token-id*.
7. In the **Password** field, type the password that is used to access the cloud server. For an Atmos device, this is the *shared secret*.
8. Select the **Cloud** tab to specify additional information specific to the cloud backup device.
9. In the **Server** field, type the IP address or fully qualified domain name of the cloud server.
10. Use the Parameter options to adjust network communication attributes:

- a. In the **Network Write Size** field, specify the amount of backup data, in kilobytes, to cache in memory before sending to the cloud. Larger write sizes typically result in better performance but results vary depending on the underlying network characteristics. Also be aware that larger sizes consume more memory on the storage node for the duration of the backup or recover operation.
 - b. In the **Number of Retries** field, specify the number of times that NetWorker will attempt to send backup or receive recover data in the event of a network failure.
 - c. In the **Send/Receive Timeout** field, specify the number of seconds that NetWorker will wait for confirmation that network send and receive transmissions to the cloud server have occurred successfully. If the timeout period expires, the data transmission is considered to have failed.
 - Set the value of this field in conjunction with the Network Write Size field. Larger Network Write Size values require larger Send/Receive Timeout values to avoid failures. Optimal values for the Send/Receive Timeout field vary depending on the network speed and bandwidth.
 - The save group's Inactivity Timeout value can potentially interact with the Send/Receive Timeout value in unintended ways. To avoid this possibility, ensure that the save group's Inactivity Timeout value (default is 30 minutes) is greater than the Send/Receive Timeout value (default is 30 seconds).
 - d. In the **Network Failure Retry Interval** field, specify the number of minutes that a backup or recover session must wait before a failed network connection results in an aborted backup or recover session.
11. In the **Compression** field, select a compression level for data that is sent to the cloud. Faster compression speeds result in less data compression but also require less CPU resources. The fastest compression speed, Compression Speed Fast, performs the least amount of data compression and is selected by default.

To choose an optimal compression value, balance the potentially longer backup window of using a slower compression speed against the potential efficiency and cost savings of sending less backup data to the cloud.

Note: If the NetWorker Cloud Back Option determines that backup data cannot be compressed effectively, compression may not occur regardless of the setting in this field.

12. In the **Encryption** field, specify whether to enable or disable encryption of data sent to the cloud. Encryption is standard NetWorker AES 256 bit encryption and is selected by default. If desired a NetWorker datazone passphrase can be defined that would be used to recover encrypted data.

If this option is selected, encryption will occur regardless of any client-side encryption directives. For more information about encryption including how to specify a new datazone passphrase, refer to [“Encrypting backup data” on page 77](#).

Note: If encryption is already enabled for the NetWorker client and encryption is enabled in this field, backups will be slower because encryption functions will occur twice.

13. Use the **Cloud network interface** field if the Storage node has multiple network interfaces. If it does, specify the IP address of the network interface that will send backup data to the cloud.

To display the **Cloud network interface** field, select **View>Diagnostic Mode** from the menu bar.

14. Select **Throttling** and then click the Bandwidth icon  to display a dialog box where you can adjust the maximum internet bandwidth that a cloud backup or recovery operation can consume at any given time of the day or week. This option enables you to prevent network congestion by limiting cloud backup and recovery activity during peak internet usage.
 - a. Select **New** to add a bandwidth throttling policy.
 - b. From the **Day** field, select the day of week to which the policy applies.
 - c. Click the up and down arrows to select a time of the day to which the policy starts and ends. Alternatively, type the times directly into the **Start time** and **End time** fields.
 - d. Click the up and down arrows to select the maximum possible network bandwidth, in megabits per second, that a backup or recovery operation can consume when the policy is in effect. Alternatively, type the values directly in the fields.

You can create as many policies per day as required. You can also modify or delete existing throttling policies as necessary.

15. Click **OK** when the configuration is complete.

Label and mount the cloud storage device

To label and mount a cloud storage device:

1. Select the cloud storage device, right-click and select **Label**. The **Create new cloud volume** dialog box appears.
2. In the Pools field, select the media pool to be used for cloud storage devices.

Note: It is recommended that the media pool you select be used for cloud backup devices only.

A label for the cloud storage device is generated and displayed in the **Volume Label** field. The label name is based on the label template that was specified for the cloud media pool.

3. Select **Mount after labeling** and click **OK**.

Note: If there are multiple cloud volumes, you will be able to select the volume to associate with the cloud storage device.

Gathering report information on cloud backup

Use cloud backup information to monitor backup costs and help optimize your cloud backups. Cloud backup information can be obtained from the following sources:

- ◆ [“Cloud backup and recover reports” on page 379](#)
- ◆ **mminfo** command
 - Use the **mminfo -avot** command to get information on how much data is consumed in a cloud backup.

Staging with a cloud storage device

Staging with a cloud storage device works the same way as staging to a tape device. You cannot however, use a cloud storage device as the source for a staging operation. [Chapter 10, "Staging Backups"](#) provides more information.

Cloning to a cloud storage device

Cloning with a cloud storage device works the same way as cloning with any other advanced file type device. [Chapter 9, "Cloning"](#) provides more information.

Deleting libraries and devices

There are slight differences between how to delete a library and how to delete a device of any type.

How to delete a library

To delete a library from a storage node:

1. In the server's **Administration interface**, click **Devices**.
2. Select **Libraries** in the navigation tree. The **Libraries detail** table appears.
3. In either the navigation tree or in the **Libraries detail** table, right-click the entry for the library to be deleted, and select **Delete**.
4. When prompted, click **Yes**.

This message appears:

```
"Are you sure you want to delete this jukebox? If so, please
re-attempt
deletion within a minute."
```

5. Click **OK** to confirm the deletion.

The library's devices remain, and can still respond to NetWorker operations (such as monitoring, labeling, deletion, and so on) after the library definition is deleted. A deletion of a library deletes the library, not its devices.

How to delete a device

To delete a stand-alone device, file type device, advanced file type device, or a device in a library (after the library's definition has been deleted) from a storage node:

1. In the server's **Administration interface**, click **Devices**.
2. Select **Devices** in the navigation tree. The **Devices detail** table appears.
3. Right-click the device entry in the detail table, and select **Delete**.
4. Click **Yes** to confirm the deletion.

Notes:

Any attempt to remove a device from a library before the library itself (the library's definition) has been removed will result in an error message.

An AFTD read-write device and volume as well as its corresponding read-only device and volume must be unmounted before it can be deleted. If the read-write or read-only device or volume is mounted, an error message will explain how to display and select the mounted device or volume so that it can be unmounted.

Library slots

The available slots feature controls which volumes the NetWorker server uses for backup. The server uses all of the volumes in a library to perform recoveries, but the volumes that are automatically selected for backups can be controlled by designating a range of available slots in the library.

Note: Ensure that volumes have been placed in all the available slots of the library so that the NetWorker server can proceed uninterrupted with an automatic backup. With two-sided media, the number of available slots is effectively doubled. For example, with 32 optical disks labeled "jupiter.001.a" to "jupiter.032.b," there is a total of 64 sides and, therefore, 64 slots from which to choose.

How to configure library slots

To configure which slots are available in a library:

1. In the server's **NetWorker Administration** interface, select **View>Diagnostic Mode** from the menu bar.
2. Click **Devices**.
3. Open the **Libraries** folder in the navigation tree. The **Libraries** detail table appears.
4. In either the navigation tree or in the Libraries detail table, right-click the library on which the slots are to be designated, and select **Properties**. The **Properties** window appears.
5. Select the **Advanced** tab of the **Properties** window.
6. In the **Media Management Area**, in the **Available slots** field, type a range of contiguous slots, then click **+** to add the range of slots.

For example (assuming that no slots have already been configured), to designate slots 1 through 3 as available, then skip a defective slot 4, and designate slots 5 through 7 as available, type this information in the **Available Slots** field:

- a. Type **1-3**, then click **+** to add these slots.
- b. Type **5-7**, then click **+** to add these slots.
- c. Click **OK**. Slot 4 will be skipped when tapes are loaded.

Troubleshooting autoconfiguration failure

Common symptoms of library autoconfiguration failure include the following:

- ◆ The library is not listed in the **Libraries** folder in the **Administration** interface.

- ◆ The library is listed, but is listed as being unconfigured.

Common causes include:

- ◆ Device drivers are not properly installed.
- ◆ Autodetection fails to match a detected library with its devices due to:
 - Out-of-date device firmware.
 - Failure of the library to return its devices' serial numbers.
- ◆ Autodetection failed to start on the storage nodes.

To troubleshoot this problem:

1. Check **Monitoring > Log** for relevant messages.
2. From the command prompt, type the following command to verify that the library returns the serial numbers of its devices:

```
sn -a b.t.l.
```

where `b.t.l.` refers to the bus target LUN of the library. If the bus target LUN is not known, run the **inquire** command first, to obtain this information.

This chapter covers these topics:

◆ Overview of NetWorker scheduling	130
◆ Backup groups	130
◆ Managing backup groups	137
◆ Backing up open files.....	139
◆ Schedules	140
◆ Backup levels	147
◆ Save set consolidation.....	153

Overview of NetWorker scheduling

Together, the following two items enable the scheduled backup of client data:

- ◆ Group
- ◆ Schedule

Time-based groups (backup groups) specify either the time of day when a backup occurs, or a probe-based backup that is user defined.

For time scheduled backups, times typically occur after regular work hours. All clients assigned to a group will be backed up at the time specified by the backup group. Schedules enable you to specify the day of the week or month that the backup occurs, as well as the level of backup (full, incremental, or level 1-9).

For probe-based backups the probe interval and backup window are used to schedule group probes with clients, and clients with groups. The execution of the probes determines if the backup of the group will proceed.

Note: Each client in a group can have a probe associated with it, but a probe is not required. However, a probe-based backup group must have at least one probe-enabled client associated with it.

Backup groups

Time-based backup groups specify the starting time for a client's scheduled backup. These backup groups enable you to:

- ◆ Schedule the backups to take place in the middle of the night, or some other time when network traffic is low.
- ◆ Balance the backup loads by grouping clients in specific groups and staggering their start times.

Note: Do not place both regular and deduplication clients in the same group.

- ◆ Sort data to specific backup volumes.
To sort data, groups are used in conjunction with backup pools. [Chapter 7, "Sorting Backup Data"](#) provides more information.

The NetWorker server and time-based backup groups

When a Client resource is created, it is assigned to a backup group. The clients in each time-based backup group begin their automatic scheduled backups according to the start time of the group. Backup loads are balanced by taking the client's backup schedule into account when determining which clients to include in a specific group.

Example 6 Using groups to balance client backups

[Figure 11 on page 131](#) illustrates how the NetWorker server uses two time-based backup groups to back up multiple client save sets. In [Figure 11](#), three client computers (mars, jupiter, and saturn) are part of a group named Weekly Full. The Weekly Full group starts its automatic scheduled backup at midnight.

- ◆ Client mars runs a full backup of all its save sets every Monday and incremental backups of its save sets on the other days.
- ◆ Client jupiter runs a full backup of all its save sets on Tuesday and incremental backups on the other days.
- ◆ Client saturn runs a full backup of all its save sets on Wednesday and incremental backups on the other days of the week.

Because each client runs its full backup on a different day of the week, the server is not overloaded.

The second group, Accounting, illustrates how you can group clients by department. The Accounting group contains client computers *mercury* and *venus* and starts its backups at 7:00 P.M., when the computers in that department are available for backup. Although the two client computers run full backups on the same day, computer *venus* is scheduled to perform a full backup on only the `/usr/home` save set, whereas all the save sets on computer *mercury* are backed up. By estimating how long a backup takes, you can determine the start time to set for the next group.

The save sets from each group are written to appropriate volumes mounted on storage devices. The NetWorker server uses pools to organize, track, and store save sets. The server uses groups to determine the time clients start their scheduled backups.

Group:	Weekly Full	Group:	Accounting
Daily Start Time:	24:00 (Midnight)	Daily Start Time:	19:00 (7:00 P.M.)
Client:	mars	Client:	mercury
Save Set:	All	Save Set:	All
Schedule:	Full on Monday Incremental, all other days	Schedule:	Full on 1st of month Level 5 on 15th of month Incremental on all other days
Client:	jupiter	Client:	venus
Save Set:	All	Save Set:	<code>/usr/home</code>
Schedule:	Full on Tuesday Incremental on all other days	Schedule:	Full on 1st and 15th of month Incremental on all other days
Client:	saturn		
Save Set:	All		
Schedule:	Full on Wednesday Incremental on all other days		

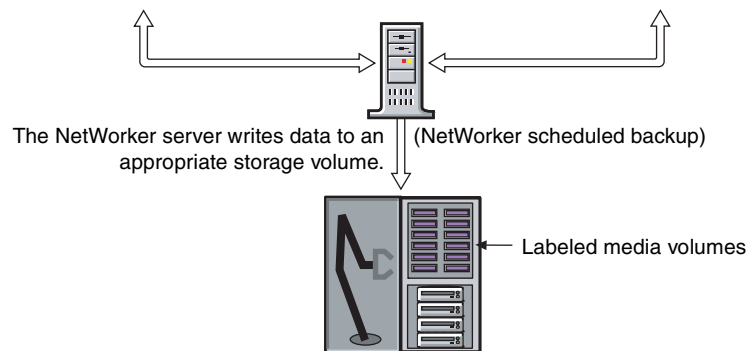

Figure 11 How NetWorker groups are used to back up multiple clients

Creating and scheduling a probe group

Note: Each client in a group can have a probe associated with it, but a probe is not required. However, a probe-based backup group must have at least one probe-enabled client associated with it.

To configure the probe-enabled group:

1. In the server **Administration interface**, click **Configuration**.
2. Right-click **Groups**, and select **New**.
3. In the **Advanced** tab of the **Create Groups** window, complete the fields in the **Probe** section as described in [Table 15 on page 132](#).

Table 15 Probe group fields

Field	Description
Probe-based group:	Click the checkbox to enable probing.
Probe interval:	Determines the frequency of probing. Can be set from a minimum of 15 to a maximum of 10,000 minutes. Note: A successful backup does not disable probing. Be sure to set the Probe interval to an appropriate value.
Probe start time:	The time at which probing will begin.
Probe end time	The time at which probing will end.
Probe success criteria	<ul style="list-style-type: none"> • Any: Any one of the probes associated with the group must succeed for the backup to be performed. • All: All of the probes associated with the group must succeed for the backup to be performed.
Time since successful backup	The longest period of time tolerated without a backup.

Probe-based backup groups specify probe interval, and backup window to schedule the group.

Probing occurs continuously throughout the probing window (the hours defined Probe start time, and Probe end time), and only when the Autostart attribute of the save group is enabled. If a save group is started manually, probes run immediately. If autostart is used, then probes only run during the specified probe window.

Clients are associated with probe-based backup groups in the same manner as they are with regular backup groups. However probe-based backup groups must include at least one client which references a probe resource as described in [“Creating a client probe” on page 473](#).

Each client can reference only one probe but, since backup groups can contain many clients, multiple probes can be run with the group.

Instead of a start time, the probe start and end times are used to schedule the group. It is the outcome of the probing which determines if the backup will proceed.

Preconfigured groups

The NetWorker product ships with a single preconfigured group named Default. To ensure that all data is backed up, the NetWorker server automatically adds all clients to the Default group. However, you must enable the Default group for the NetWorker server to back it up. You can keep a client in the Default group, or you can put the client in one or more customized groups.

You can also make changes to any Default group attribute, but you cannot delete the group. You can, however, create or delete as many customized groups as required.

Key Group attributes

Table 16 displays some of the key attributes for the Group resource.

Table 16 Group attributes (1 of 2)

Attribute	Description
Start Time	The Default group is preconfigured to start its daily backup at 3:33 A.M. This time can be changed.
Autostart	Specifies whether the group is started automatically at a designated start time. You must enable the Autostart attribute for the Default group, and any other group you create, before a scheduled backup can be run.
Schedule	This optional attribute can be used to select a Schedule resource for the group. If this attribute is set, it overrides the schedules selected in the Client resource's Schedule attribute for all clients in this group.
Interval	This attribute dictates how often a group starts a scheduled backup. The default value is 24:00 (once a day), but you can change this value to start backups more often. "Setting the backup group time interval" on page 135 provides instructions on modifying this attribute.
Autorestart	Specifies whether the group will be automatically restarted after an incomplete backup due to a power failure or administrator intervention. If this attribute is enabled, the backup will restart when the NetWorker server is restarted provided that the period of time specified in the Restart Window attribute has not elapsed.
Restart Window	For either auto or manual restarts, this attribute specifies the period of time in which an incomplete backup can be restarted. If the period of time has elapsed, the restart will be treated as a regular backup start operation. The restart period is calculated from the beginning of the start of the last incomplete backup. The default value is 12:00 hours. This value cannot be greater than the Interval attribute.
Client Retries	When the NetWorker server fails to connect to a client, this attribute specifies the number of times that the server will reattempt the connection before the backup is considered a failure. The first retry will not occur until after an attempt has been made to at least contact each client in the group.
Inactivity Timeout	This attribute specifies the maximum time, in minutes, that a client is given to fail to communicate back to the server. If a client fails to respond beyond the Inactivity Timeout value, the server will consider the client as having failed. If a client fails due to any reason, a retry is initiated immediately. This ensures that no time is lost during the scheduled backup due to any failures. Note: For large save sets, for save sets with large sparse files, and for incremental backups of a large number of small static files, increase the timeout value if the backup consistently aborts due to an inactive job.
Soft runtime limit	This attribute indicates the time in minutes since the start time of a given group after which no new child process will be launched. The Soft runtime limit is measured for each savegroup separately. Index and bootstrap saves are exempt and will be started regardless of this setting. The default value is 0, which indicates that no Soft runtime limit is in effect.
Hard runtime limit	This attribute indicates the time in minutes that any save session still running will be terminated and the savegrp aborted. The default value is 0, which indicates that no Hard runtime limit is in effect.

Table 16 Group attributes (2 of 2)

Attribute	Description
Success Threshold	This attribute sets the criteria for reporting the success of all save sets within a group. The default value is Warning which means if any save set completes with warnings it will be reported as successful. The client will also be reported as successful with warnings in the completion report. If set to "Success", any save sets completed with warnings will be reported as failures. The client will also be reported as failed in the savegroup completion report. Note: Any failures will invoke a retry on the save set if retry count is not 0.
Probe based backup	If this attribute is set to ON, the probe attributes listed below become enabled. Boolean ON/OFF. It is OFF by default.
Probe interval	This attribute indicates how often probes (in minutes) should be run. Default value is 60 minutes.
Probe start time/probe end time	Probe start time and probe end time together define the backup window. Probe end time minus probe start time should be greater than the probe interval. Start time default: 0:00; end time default: 23:59
Probe success criteria	This attribute determines if all probes or only one probe needs to succeed for a backup to proceed. Values are Any or All.
Time since successful backup	If set to 0, time since the last successful backup will not matter: savegrp always runs probes. If interval is specified and reached, savegrp will run the backup no matter what the result of the rest of the probes. The probes are run, so that the probe state data can be updated. Default is 0 days.
Time of the Last Successful Backup	Set to the time of the last successful backup by savegrp . Used to calculate interval since the last successful backup. GUI read only.
savegrp Parallelism	Maximum number of save sets that can be backed up simultaneously by a NetWorker group. The default value is 0, which means that parallelism is not restricted. "Parallelism" on page 437 provides information about savegrp parallelism.

Aborted backup groups

If the backup of a save set fails, then the NetWorker server marks the save set as "aborted." In this situation, the automated report from the **savegrp** program does not always show that the backup has completed. For example, if the client is being backed up over a Network File System (NFS) connection and the NFS server crashes and reboots, the NetWorker backup hangs until it times out. The NetWorker server marks the save set "aborted."

How to create a group

["Task 2: Set up a group for backup clients" on page 57](#) provides information about creating a group.

How to edit a group

Note: You cannot change the name of an existing backup group.

To edit a group:

1. From the **Administration** window, click **Configuration**.
2. In the expanded left pane, select **Groups**.
3. Select the group to be edited.
4. From the **File** menu, select **Properties**.
5. Edit the attributes of the group and click **OK**.

How to delete a group

Note: You cannot delete the preconfigured Default group nor any group currently applied to a Client resource.

To delete a group:

1. From the **Administration** window, click **Configuration**.
2. In the expanded left pane, select **Groups**.
3. Select the group to be deleted.
4. From the **File** menu, select **Delete**.

How to copy a group

To copy a group:

1. From the **Administration** window, click **Configuration**.
2. In the expanded left pane, select **Groups**.
3. In the right pane, right-click the group to be copied and select **Copy**. The **Create Group** dialog box appears, containing the same information as the group that was copied, except for the Name attribute.
4. In the **Name** attribute, type a name for the new group.
5. Edit the attributes and click **OK**.

Copying a group with clients

The Copy with Client feature allows you to copy an existing group resource including the associated group and all client resources. The Copy with Clients operation enables the following actions:

- ◆ Copy an existing NSR group.
- ◆ Ensure the original client list is preserved in the new group.
- ◆ All NSR client resources are automatically updated.

Note: The Copy with Clients operation is only available to a NSR group resource type. Consequently, the new functionality is only available if a NetWorker group is selected in the configuration window in the NetWorker console.

The Copy with Clients option is available in under the Edit menu. The option is also available in a pop-up menu that appears when an individual group is selected in the details pane or navigation tree.

Setting the backup group time interval

The NetWorker server allows you to run an individual scheduled backup group more than once within a 24-hour period. The Interval attribute value of the Group resource determines the frequency (in hours) that an individual group will start a backup.

The default value is 24 hours (24:00), which results in one backup group run per day. If you set the Interval attribute value at 12 hours, then the same group will back up twice a day. For example, a group with the default start time of 3:33 A.M. and an interval of 12:00 would back up twice a day, first at 3:33 A.M., and then again twelve hours later at 3:33 P.M.

To set backup group time intervals:

1. Select the group to edit. For information about editing a group, see [“How to edit a group” on page 134](#).
2. Select the **Advanced** tab.
3. In the **Interval** attribute, type a value in the hh:mm format.

For best results, use time interval values that make it easy to determine the backup group time, such as 24, 12, or 6 hours.

4. Click **OK**.

Note: An increase in the backup group time interval (for example, changing the interval from once every 24 hours to once every 12 hours) can add strain on a network, the NetWorker server, and associated devices.

Limiting full backups when the time interval is less than 24 hours

For groups that have more than one scheduled backup within a 24-hour period, use the Force Incremental attribute to prevent more than one full or level backup per 24-hour period. By default, the Force Incremental attribute is set to Yes. If the Force Incremental attribute is set to Yes, the first backup is performed at the configured level. All subsequent scheduled backups during the next 24 hours after the start of the first backup will be incremental. This means that only changed files will be backed up regardless of the configured level. The Force Incremental attribute applies only to scheduled backups that the NetWorker server runs automatically. If the **savegrp** program is run by other means, such as from the command prompt or a script, this attribute is not used.

If the Force Incremental attribute is set to No, multiple full or level backups are allowed during the 24 hours after the start time of the first backup.

Forcing an incremental backup

To force incremental backups on groups:

1. Select the group to edit. [“How to edit a group” on page 134](#) provides information about editing a group.
2. Select the **Advanced** tab.
3. Select the **Force Incremental** attribute and click **OK**.

[“Setting the backup group time interval” on page 135](#) provides information about how to configure backup groups to occur more than once every 24 hours.

Managing backup groups

Table 17 on page 137 lists backup group management tasks and where to find more information about these tasks.

Table 17 Backup group management

Group Management Task	For more information
Start a group immediately	“Starting a group immediately” on page 395
Stop a group immediately	“Stopping a group” on page 396
Restart a group	“Restarting groups” on page 396
Preview a backup group	“Previewing a backup group” on page 137

Previewing a backup group

You can simulate a backup for a specific group. This feature generates an output that includes this information:

- ◆ File System to be backed up
- ◆ Backup level
- ◆ Backup pool

Preview a backup to identify potential problems before the NetWorker server runs a backup group.

To preview a backup group:

1. Select the group to edit. Information about editing a group is available in [“How to edit a group” on page 134](#).
2. Select the **Advanced** tab.
3. In the **Option** attribute, select **Preview** and click **OK**.

To see the simulated results of the backup, open the daemon log file located in the <NetWorker_install_dir>\logs directory. Information about viewing log files is available in [“Viewing log files” on page 663](#).

Moving clients between groups

Multiple clients may be moved from one group to another by selecting the clients and dragging them to another group.

Note: Do not place both regular and deduplication clients in the same group.

Estimating save set sizes of a backup group

You can estimate the size of the save sets that will be produced in a backup group before the backup is run.

To estimate save set sizes of the backup group:

1. Select the group to edit. Information about editing a group is available in [“How to edit a group” on page 134](#).
2. Select the **Advanced** tab.
3. In the **Option** attribute, select **Estimate**, **No Save**, and **Verbose**.
4. Click **OK**.

To see the estimated save set sizes, open the daemon log file located in the `NetWorker_install_dir\logs` directory. [“Viewing log files” on page 663](#) provides information about viewing log files.

Note: Selecting the Estimate, No Save, and Verbose options produces an estimate that shows all paths and filenames that will be saved in the backup group. Selecting the Estimate and Verbose options produces a detailed estimate and performs the save in a single operation. Selecting only the Estimate option (without the No Save or Verbose option) results in a save operation without an estimate.

Backing up status reports

When the backup is completed, several types of backup status reports are generated:

- ◆ [Chapter 14, “Reporting”](#) provides information about these reports.
- ◆ Information about the status of backed-up groups is also written to the savegrp log file, which is located in the `NetWorker_install_dir\logs` directory.
- ◆ [“Viewing log files” on page 663](#) provides information about viewing log files.

Generating and printing bootstrap reports

When the backup group includes the NetWorker server, or if the server is not in an active group, the server generates a special save set called the *bootstrap*, which includes the media database and configuration files. In both of these cases, a bootstrap email (default) or printout is generated whether the scheduled backup is initiated automatically or manually. The bootstrap information is essential for recovery from a disaster. For information on how the bootstrap is used during a disaster recovery operation, refer to the *EMC NetWorker Disaster Recovery Guide*.

Note: If the NetWorker server is not a member of an active group, the bootstrap is created when any group backup is run, even if the group has a level of “skip.” However, in this case the bootstrap will be created only once every 24 hours, regardless of how many groups are run during that period. If you would like to create bootstraps for every group backup, you should include the server in the group, with a very small save set (such as `/etc/hosts`).

By default, the bootstrap reports are generated and sent as an email to the default email recipient, either the administrator or root. To change the email recipient, open the Bootstrap notification and configure a new email recipient.

Note: User can also choose to get the reports printed through the default printer configured for the NetWorker server. To change the default printer, edit the **Printer** attribute in the Group resource.

If the bootstrap notification is configured for email (default option) and an email recipient is not configured, then the bootstrap reports are lost. However, when an email recipient is later configured, the bootstrap reports are generated the next time as part of the **savegrp** operation and the previous reports are also sent to the email recipient along with the current report.

If the bootstrap notification is configured to the printer (not the default configuration) and bootstrap report fails for any reason, then the contents can be viewed in the `savegrp.log` file which is located in the `<install_dir>\logs` directory, or the `savegrp` report. [“Viewing log files” on page 663](#) provides information about viewing log files.

Backing up open files

Open files are a problem that all data backup applications must solve. Open files that are not backed up properly represent a potential data loss. They might be skipped, improperly backed up, or locked.

NetWorker can open two different types of files. Those that are owned by the operating system and those that are owned by a specific application.

Opening files owned by the operating system

Most open files that are owned by the operating system can be backed up. However, some applications can apply operating system locks to open files. These locks prevent other applications, such as NetWorker software, from writing to or reading from the open file.

The NetWorker software normally skips locked files and returns the message:

```
save: file_name cannot open
```

Additionally, a permission denied error may be returned from the operating system.

To back up locked open files, close any open files. However in most cases, this is impractical. To automate this process, create a pre- and postprocessing backup command that shuts down specific applications, backs up the open files, and then restarts any applications after the backup finishes. [Chapter 2, “Backing Up Data”](#) provides more information. Also use Open File Manager to back up open files.

Opening files owned by a specific application

The NetWorker software by itself cannot normally back up an open file that belongs to a specific application, like a database. To back up these open files, use a NetWorker Module. For example, use the NetWorker Module for Oracle to back up open files in an Oracle database.

Files that change during backup

If a file changes during a backup, the NetWorker software alerts you by displaying the following message in the **Groups** tab of the **Monitoring** option:

```
warning: file_name changed during save
```

To ensure that the changed file is backed up, do either of the following:

- ◆ Restart the backup group.
- ◆ Perform a manual backup. Information is available in [“Manual backups” on page 64](#).

Note: NetWorker Modules can back up these types of files correctly, if they are files related to the database the module is backing up.

Backing up open files with VSS

In NetWorker releases 7.2 and later, if a VSS client license is present, the software takes advantage of VSS technology to create snapshot backups of volumes and exact copies of files, including all open files. In this way, files that have changed during the backup process are copied correctly. [Chapter 25, “Volume Shadow Copy Service,”](#) provides more information about VSS.

Schedules

Each Client resource is backed up according to a schedule. A Client resource’s backup schedule tells the NetWorker server what level of backup (for example, full or incremental) to perform on a given day. For instance, on Fridays it might perform a full backup on a Client resource and the rest of the week perform incremental backups. The time of day the backup begins is determined by the group to which the Client resource is associated.

Schedules can be simple or complex, depending on the needs of the environment. All Client resources can share the same schedule, or each can have a unique schedule.

The type and scope of the backup is determined by the specified backup level. The level can be set to back up a client’s entire file system, or only data that has changed since the last full backup.

[“Backup levels” on page 147](#) provides information about backup levels.

Schedules for Avamar deduplication clients

Backups must be scheduled to avoid the Avamar node’s read-only periods when such cron jobs as checkpoint and garbage-collection are run. The Avamar server documentation provides more information.

The *NetWorker Avamar Integration Guide* provides backup level and schedule information that is specific to Avamar clients.

Preconfigured NetWorker schedules

The NetWorker software ships with preconfigured schedules. If these schedules meet backup requirements, use them as is. Otherwise, create new schedules to accommodate any site-specific needs.

Preconfigured schedules cannot be deleted. Preconfigured schedules that contain “overrides” (indicated by an asterisk next to a backup level in the schedule’s calendar) cannot be modified. All other preconfigured schedules can be modified.

[Table 18 on page 141](#) describes the preconfigured schedules.

Table 18 Preconfigured NetWorker schedules

Schedule name	NetWorker backup operation
Default	Completes a full backup every Sunday, incremental backups on all other days.
Full Every Friday	Completes a full backup every Friday, incremental backups on all other days.
Full on First Friday of Month	Completes a full backup on the first Friday of the month, incremental backups on all other days. This schedule cannot be modified.
Full on First of Month	Completes a full backup on the first calendar day of the month, incremental backups on all other days.
Quarterly	Completes a full backup on the first day of a quarter. Performs a level 5 backup on the first day of the other months in the quarter. Every seven days, a level 7 backup occurs. Incremental backups are performed on all other days. This schedule cannot be modified.
Consolidate Every Friday	Completes a consolidated backup every Friday. Completes incremental backups on all other days.
Consolidate on First Friday of Month	Completes a consolidated backup on the first Friday of the month. Completes incremental backups on all other days. This schedule cannot be modified.
Consolidate on First of Month	Completes a consolidated backup on the first calendar day of the month. Completes incrementals on all other days of the month.
Consolidate Quarterly	Completes a consolidated backup on the first day of each quarter. Completes incremental backups on all other days of the quarter. This schedule cannot be modified.

Backup cycles

The period of time from one full backup to the next full backup is called a backup cycle.

The following examples demonstrate how to use schedules for different backup cycles and client backup needs.

Example 7 Weekly backup cycle

Figure 12 on page 142 illustrates a weekly backup cycle. In this example, a full backup is performed on a client each Sunday, and incremental backups are performed on the other days of the week.

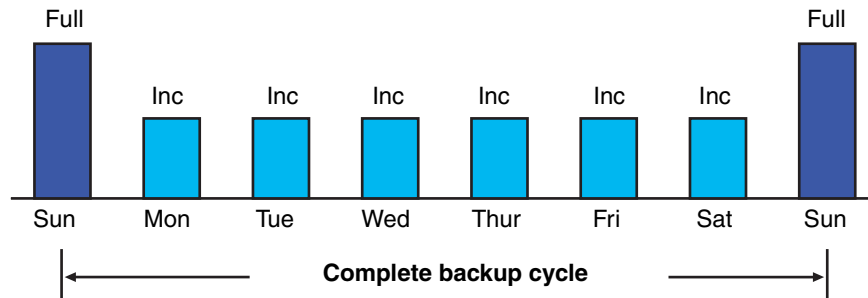

Figure 12 Weekly backup cycle

Use backup schedules to balance and stagger the load on a NetWorker server. Depending on the size of a network, you could apply the same schedule to all clients. For example, if no one works over the weekend and you want to run full backups during this time, you could apply the Default schedule to all of the clients.

The Default schedule tells the NetWorker server to perform full backups on Sunday, and incremental backups the rest of the week.

Example 8 Default schedule for multiple clients

Figure 13 on page 142 illustrates how the Default schedule works for three clients.

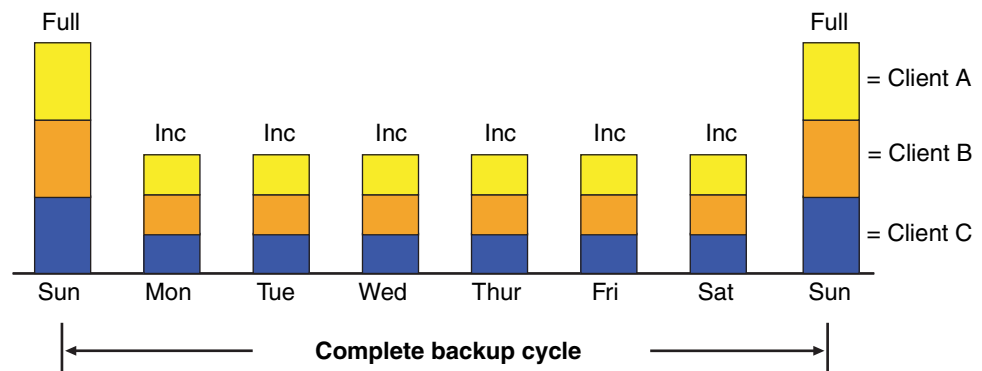

Figure 13 Default schedule for multiple clients

Note: If you have a short backup window period and need to create a full backup, you can use the consolidation backup. A consolidation backup uses the most volume space because it holds both a level 1 and a consolidated full backup. However, data recovery is faster because of the full backup. [“Save set consolidation” on page 153](#) provides details.

Since full backups transfer large amounts of data and typically take longer than other backup levels, you may want to stagger them throughout the week. For example, you could apply a schedule that performs a full backup for Client A on Thursday, a second schedule that performs a full backup for Client B on Tuesday, and a third schedule that performs a full backup for Client C on Sunday.

Example 9 Staggered weekly schedules for multiple clients

Figure 14 on page 143 illustrates how to use a staggered backup schedule for multiple clients.

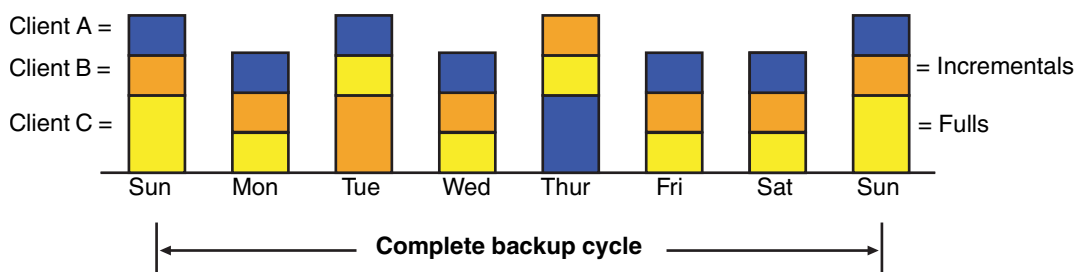

Figure 14 Staggered weekly schedules for multiple clients

By balancing and staggering the load, and using different start times for different groups of clients, you can increase the efficiency of a NetWorker server.

Scheduling and planning considerations

Deciding which schedules are most appropriate for an environment requires planning.

When you create backup schedules, consider:

- ◆ How much data do you have to back up?
- ◆ How many backup media volumes do you plan to use?
- ◆ How much time do you have to complete a backup?
- ◆ Does it matter how many volumes are required to recover from a disaster, such as a disk crash?

Additionally, determine a policy for recovering files. For example, if users expect to be able to recover any version of a lost file that was backed up during a three-month period (that is, the retention policy is three months), you need to maintain all of the backup volumes for a three-month period. On the other hand, if users expect to be able to recover data from only the last month, you will not need to maintain as many volumes.

The length of time that data is available for recovery by the NetWorker server is determined by the browse and retention policies associated with each client.

[Chapter 5, “Browse and Retention Policies”](#) provides information about browse and retention policies.

Scheduling large client file systems

At a moderate backup rate of 400 KB per second, a full backup for a client with 10 GB of data takes about seven hours to complete. Consequently, it might not be convenient to perform a scheduled, full backup for client save sets as large as this because of the amount of time required.

Schedule the client’s disk volumes for backup at different times by separating them into different backup groups. When you split one client’s save sets into multiple backup groups, you back up all the client’s files, but not all at once. It is less time-consuming than a full backup of all the local data at one time.

To back up the client's file systems individually, add and configure the same client several times by addressing the different file systems in the Client resource. For example, configure the first Client resource to back up one file system (C:\) with a single backup schedule in one group. Then, configure the second Client resource to back up another file system (D:\) with a second backup schedule in another group.

Note: When you create separate backup schedules and explicitly list save sets, any files or file systems not included in that list are omitted from backup. This includes any new disk volumes that are added to the system. To avoid this risk, type the value All in the Save Set attribute.

Key components of a schedule

[Table 19 on page 144](#) describes the key components of a Schedule resource.

Table 19 Key components of a schedule

Attribute	Description
Name	The name assigned to a customized schedule that appears in the Client resource as an attribute, and can be applied to a client/save set. Assign a simple, descriptive name such as Monday Full.
Period	Determines how often a full backup is to run. Set the schedule to apply to either a weekly or a monthly period. When you select Week and set up a schedule, the backup level full is applied to the same day of the week for all weeks in the calendar year. For example, full backups every Sunday. Week is the default setting. When you select Month and set up a schedule, the backup level full is applied to the same day of the month for all months in the calendar year. For example, full backups on the fifteenth of each month.
Calendar	Displays the days of the month and the backup level scheduled for each day. In addition to full and incremental backups, you can set intermediate backup levels. You can include one or more of these levels in a backup schedule: <ul style="list-style-type: none"> • Full • Incremental • Level (1 – 9) • Consolidated • Skip The Override Levels option allows you to override an existing backup level for a specific day. For example, you might not want a full backup to run on a holiday. You can override the schedule so the full backup runs on the day before or the day after the holiday. An asterisk next to a backup level indicates that an override has been set for that day. <p>"Backup levels" on page 147 and "Save set consolidation" on page 153 provides more information on how backup levels work.</p>

Note: The Force Incremental attribute in the backup group, determines the level used by the NetWorker server when there is more than one backup per day. The default value for this attribute is Yes, which means that an incremental backup will occur if the group is run more than once a day. To perform more than one full or level backup per day, set this attribute to No. ["Limiting full backups when the time interval is less than 24 hours" on page 136](#) provides more information.

Working with schedules

This section provides information on how to edit, delete, and copy schedules.

Note: “Task 1: Set up a schedule for backups” on page 56 provides information about creating a schedule.

Editing a schedule

To edit a schedule:

1. From the **Administration** window, click **Configuration**.
2. In the expanded left pane, select **Schedules**.
3. In the right pane, select the schedule to edit.
4. From the **File** menu, select **Properties**.
5. Edit the attributes and click **OK**.

Deleting a schedule

Note: You cannot delete preconfigured schedules or schedules that are currently selected in a client’s Schedule attribute.

To delete a schedule:

1. From the **Administration** window, click **Configuration**.
2. In the expanded left pane, select **Schedules**.
3. In the right pane, select the schedule to delete.
4. From the **File** menu, select **Delete**.
5. When prompted, click **OK** to confirm the deletion.

Copying a schedule

To copy a schedule:

1. From the **Administration** window, click **Configuration**.
2. In the expanded left pane, select **Schedules**.
3. In the right pane, right-click the schedule to be copied and select **Copy**. The **Create Schedule** dialog box appears with the same information as the schedule that was copied, except for the Name attribute.
4. In the **Name** attribute, type a name for the new schedule.
5. Edit the attributes and click **OK**.

Overriding a client’s regular backup schedule

You can set the Schedule and Level attributes in the group to override a client’s regular backup schedule. For example, one evening you could run a full backup on all the clients in a group, regardless of the clients’ regular backup schedules. The value specified in the group’s Level attribute overrides the backup level setting for every client in the group.

Alternatively, you could have a group of clients follow the same backup schedule instead of each client's individual schedule. You could assign a group of clients to follow the default schedule (full every Sunday) regardless of each client's individual schedule. If you leave the group's Level and Schedule attributes blank (the default setting), clients follow the backup schedule assigned in the Client resource.

Disabling or enabling a client backup schedule

By default, the schedule assigned to the backup client is enabled.

To disable scheduled backups for a client:

1. Open the **Client** resource whose scheduled backups are to be disabled. [“Editing a client” on page 470](#) provides more information.
2. Clear the **Scheduled Backup** attribute and click **OK**.

Client timezone adjustment for Windows clients

The NetWorker software enables you to schedule backups over long-distance networks. In some cases, scheduling can occur over multiple time zones.

To incorporate time zones into your backup schedules, adjust each client time zone setting by editing the client's AUTOEXEC.BAT file.

Adjusting the client time zone

To adjust the time zone for backups of a remote client:

1. Open the AUTOEXEC.BAT file by using a text editor.
2. Type these lines in the AUTOEXEC.BAT file:

```
TZ = <local_standard_timezone><+/- gmt_differences>
<local_daylight_savings_timezone>
```

[Table 20 on page 146](#) describes the time zone strings that can be adjusted in the AUTOEXEC.BAT file.

Table 20 Time zone strings

String	Description	Example
local_standard_timezone	The current standard time zone. All three characters are required.	PST is the three-character abbreviation for Pacific Standard Time.
+/- gmt_differences	The difference in the local standard time zones from Greenwich Mean Time (GMT) in hours. Positive numbers adjust westward from GMT and negative numbers adjust eastward.	The number 8 would represent Pacific Standard Time, while -1 would represent the central part of Europe.
local_daylight_savings_timezone	(Optional) The current daylight savings time zone.	PDT is the three-character abbreviation for Pacific Daylight Time.

A complete example of a time zone string is:

```
PST8PDT
```

If the TZ environment string is not present in the AUTOEXEC.BAT file, the NetWorker software presumes a default setting of TZ = EST5EDT.

Backup levels

Because it may not be practical or efficient to run full backups every day, you can specify the level of the backup to be performed during scheduled backups. By limiting the frequency of full backup, you help maintain server efficiency, while still ensuring that data is protected. Different backup levels enable you to trade off the number of volumes and amount of time required to complete a backup with that required to recover from a disk crash.

Table 21 on page 147 describes the five kinds of backup levels:

Table 21 Backup levels

Backup Level	Function
Full	Backs up all files, regardless of whether or not they have changed.
Level [1 – 9]	<p>Backs up files that have changed since the last backup with a lower-numbered backup level. For example:</p> <ul style="list-style-type: none"> • A level 1 backup backs up all files that have changed since the most recent full backup (considered a level zero). • A level 3 backup backs up all files that have changed since the most recent backup at level 2, level 1, or full. For example, if the most recent backup was at level full, then a level 3 backup will back up all files that changed since the full backup. However, if the most recent backup was at level 2, then a level 3 backup will back up only those files changed since the level 2 backup. • A level 9 back up backs up all the files that have changed since the most recent backup of any level except level 9. <p>Note: The NetWorker software ignores any incremental-level backups when determining what files should be backed up.</p>
Incremental	Backs up files that have changed since the last backup, regardless of level.
Consolidated	Backs up all data that has changed since last full backup and then merges these changes with the last full backup. Information is available in “Save set consolidation” on page 153 .
Skip	Skips the scheduled backup. For example, you can skip a backup on a holiday if no one will be available to change or add more media volumes.

Note: Information on the special nature of deduplication backups is available in the *NetWorker Avamar Integration Guide* and the *NetWorker Data Domain Depulication Devices Integration Guide*.

How NetWorker backup levels work

Backup levels work in conjunction with a client’s backup schedule. The way you define the backup levels directly affects how long a recovery from a disk crash takes and how many backup volumes you need.

Planning level backups helps to minimize the number of volumes used. The fewer volumes required to recover from a disk crash, the less time spent restoring the disk.

You can also reduce the size and time it takes to back up data by using directives. For example, use a directive to skip certain files or file systems when performing a backup. More information on directives is available in [Chapter 6, “Directives.”](#)

The following three examples illustrate the how backup levels affect the requirements for data recovery.

Example 10 Backup levels (part 1)

As shown in [Figure 15 on page 148](#), a full backup runs on October 1. On October 2, an incremental backup saves everything that changed since the full backup. On October 3, another incremental backup backs up everything that changed since October 2. Then, on October 4, a level 7 backup backs up everything that changed since the full backup on October 1.

To fully recover from a disk crash on October 4, you need the data from the full backup from October 1 and the new level 7 backup. You no longer need the data from October 2 and 3, because the level 7 volume includes that information.

Also, incremental backups on October 5, 6, and 7 back up everything that has changed since the level 7 backup on October 4.

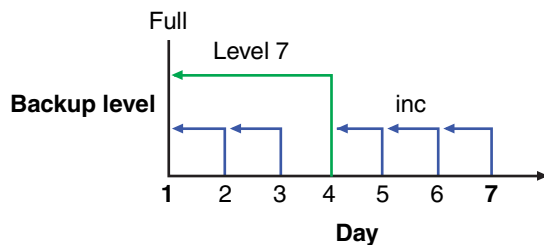

Figure 15 Backups for October 1 through October 7

Example 11 Backup levels (part 2)

[Figure 16 on page 148](#) continues the example illustrated in [Figure 15 on page 148](#) by showing a level 5 backup on October 8, which backs up everything that changed since the full backup on October 1. To fully recover from a disk crash on October 8, you only need the data from October 1 and the new level 5 volume. You no longer need the data from the level 7 backup on October 4 (or the subsequent incremental backups performed on October 5, 6, and 7) because the new level 5 backup includes that data.

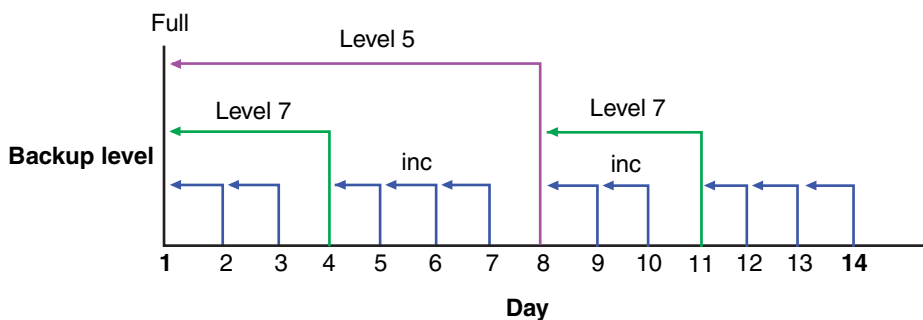

Figure 16 Backups for October 1 through October 14

Also, a level 7 backup on October 11 backs up all of the data that changed since the last lower-numbered backup (in this case, the level 5 backup on October 8). To recover from a disk crash on October 11, you need three volumes: the full volume from October 1, the level 5 volume from October 8, and the new level 7 volume.

Example 12 Backup levels (part 3)

Figure 17 on page 149 continues the example by showing a level 5 backup on October 15, which backs up all of the data that changed since the last lower-numbered backup. Because no backup lower than level 5 has been performed since the full backup on October 1, this level 5 backs up all of the data that changed since the full backup. Therefore, to recover from a disk crash on October 15, you only need the data from the full backup on October 1 and the new level 5 backup.

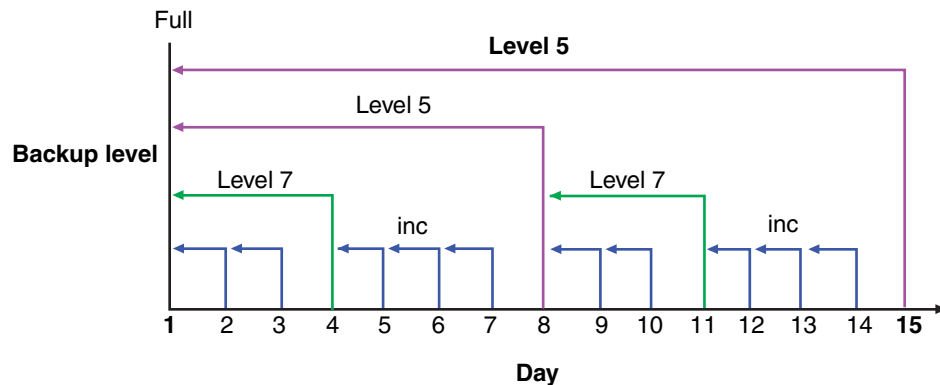

Figure 17 Backups for October 1 through October 15

The NetWorker server and backup levels

A backup schedule defines what level backup to perform on a given day. You can apply one or more backup levels to customize a backup schedule. To use backup levels in a customized schedule, consider these issues to help you decide what best suits your environment:

- ◆ Full backups generally take more time to complete than incremental backups. The exception to this is the full backup of deduplication clients. With deduplication, only the initial full backup takes longer. Thereafter, every full backup captures only the exact bits that have changed. This allows the subsequent full backups to be significantly smaller.
- ◆ If you have only one stand-alone storage device and the full backup does not fit on a single piece of media, an operator must be available to monitor the backup and change the media.
- ◆ Full backups cause the online indexes to grow more rapidly than incremental or level backups.
- ◆ Level backups serve as checkpoints in schedules because they collect all the files that have changed over several days, or even weeks, into a single backup session.
- ◆ Consolidated backups provide the same benefits at the same cost as do full backups. The difference is that consolidated backups are less taxing on the network and client because only a level 1 backup is performed. The server's performance, however, is slower because the server consolidates the changed data with the most recent full backup.

Table 22 on page 150 lists advantages and disadvantages of each backup level.

Table 22 Advantages and disadvantages of backup levels

Backup level	Advantages	Disadvantages
Full	<ul style="list-style-type: none"> Faster recovery 	<ul style="list-style-type: none"> Slow backup High server load High load on client and network Uses more volume space
Level	<ul style="list-style-type: none"> Faster backup Low load on server Uses least volume space 	<ul style="list-style-type: none"> Slow recovery Data can spread across multiple volumes
Consolidated	<ul style="list-style-type: none"> Faster backup (from the client's perspective only) Faster recovery Low load on client and network 	<ul style="list-style-type: none"> Longest high load on server Requires at least two volume drives Uses most volume space

Online indexes and backup levels

The online indexes are backed up in the following way:

- ◆ The client file index for a NetWorker client is backed up every time the client is backed up. When a client's backup level is incremental, the backup of its client file index is at level 9. For a consolidated backup, the backups of the indexes are level 9. The NetWorker server does not perform a level 1 backup for this data.

The files associated with the client file index of a NetWorker client reside on the NetWorker server. So, when a client is being backed up, its client file index is also backed up on the NetWorker server.

- ◆ The client file index for the NetWorker server client is backed up every time the NetWorker server is backed up. When the server's backup level is incremental, the backup of its client file index is at level 9. For a consolidated backup, the backups of the index is level 9. The NetWorker server does not perform a level 1 backup for this data.
- ◆ The media database and the resource database is backed up whenever the NetWorker server is backed up, or after every scheduled backup if the server is not in an active group.

For example:

- ◆ If the NetWorker server is backed up at the level full, the backup levels of the NetWorker server's client file index, the media database, and the resource database are also full.
- ◆ If the NetWorker server's backup is a level 5, the backups of the server's client file index is also a level 5.

Backup levels for the NetWorker online indexes

The NetWorker server backs up the online indexes (client file index and media database) differently than regular files and other data. Knowing how the online indexes are backed up is particularly important during disaster recoveries. [Table 23 on page 151](#) compares the level at which the NetWorker server backs up regular files and the online indexes.

Table 23 Regular file and index backup levels

Regular files	Online indexes
Full	Full
Level 1–9	Level 1–9
Incremental	Level 9
Manual (using the User program)	Not saved

The Windows Archive attribute

The Windows file Archive attribute is used by the NetWorker software to help determine if the file should be backed up. The NetWorker software backs up a file if the Archive attribute is enabled.

- ◆ After backing up the file, the NetWorker software turns off the Archive attribute.
- ◆ After restoring the file, the NetWorker software turns on the Archive attribute.

To disable NetWorker's use of the Windows file Archive attribute:

1. Set the environment variable `NSR_AVOID_ARCHIVE` to a value of **Yes**.
To set this as a system environment variable, use the Control Panel's System applet. If this variable is used, NetWorker determines a file's need to be backed up based on the traditional save criteria of modification time.
2. Log off, reboot, or restart the **NetWorker Remote Exec Service** to make Windows aware of the system environment variable change.

Backup levels for Windows SYSTEM and VSS SYSTEM save sets

This section discusses the required backup levels for the five SYSTEM save sets and six VSS SYSTEM save sets used to back up Microsoft Windows system files. More information about these save sets is available in [Appendix A, "SYSTEM and VSS SYSTEM Save Sets."](#)

Note: A backup or restore of any SYSTEM or VSS SYSTEM save set automatically includes all eligible components of that save set.

Note: Deduplication does not support the backup of SYSTEM save sets.

SYSTEM save sets

These are the required backup levels for the SYSTEM save sets.

SYSTEM STATE

For Windows XP and Windows Server 2003 with no VSS license or VSS disabled, the system state is a single logical entity. To maintain the integrity of the system state and ensure that a recovery will accurately restore the state of the machine to its condition at the time of the backup, Windows requires that the system state always be backed up in this manner:

- ◆ As a single, indivisible unit. Therefore, components of the NetWorker SYSTEM STATE save set (such as COM+ and the registry) cannot be backed up or restored individually as separate entities.
- ◆ At level full. Therefore, individual components of the SYSTEM STATE save set cannot be backed up at any level other than full. Requesting an incremental backup of the SYSTEM STATE save set, for example, always results in a full backup of the save set.

SYSTEM FILES

As with the other SYSTEM save sets, when a backup of the SYSTEM FILES save set occurs, it is always at level full. However, a requested backup of the SYSTEM FILES save set is performed only if one or more of the system-protected files have changed since the specified date and time. If no system-protected files have changed, none will be backed up and no corresponding save set entry is made in the server's media index. However, on an incremental or level 1-9 backup of the SYSTEM FILES save set, *all* system-protected files are backed up if *any* system-protected files have changed since the specified time.

SYSTEM DB

Each component of the SYSTEM DB save set (such as Disk Quota or Removable Storage) is always backed up at level full, even if another backup level is requested. SYSTEM DB save set components cannot be backed up or restored individually.

SHAREPOINT

The SHAREPOINT save set is always backed up at level full, even if another backup level is requested. There are no individual components to back up or restore.

Automated System Recovery

The Automated System Recovery (ASR) save set is always backed up at level full, even if another backup level is requested. There are no individual components to back up or restore.

VSS SYSTEM Save Sets

These are the required backup levels for the VSS SYSTEM save sets.

VSS SYSTEM BOOT

For Windows Server 2003 with VSS licensed and enabled, the system state is a single logical entity. To maintain the integrity of the system state and ensure that a recovery will accurately restore the state of the machine to its condition at the time of the backup, Windows requires that the system state always be backed up in this manner:

- ◆ As a single, indivisible unit.
Components of the NetWorker VSS SYSTEM BOOT save set (such as COM+ and the registry) cannot be backed up or restored individually as separate entities.
- ◆ At level full.
Individual components of the VSS SYSTEM BOOT save set cannot be backed up at any level other than full. Requesting an incremental backup of the VSS SYSTEM BOOT save set, for example, always results in a full backup of the save set.

VSS SYSTEM FILESET

As with the other VSS SYSTEM save sets, when a backup of the VSS SYSTEM FILESET save set occurs, it is always at level full. However, a requested backup of this save set is performed only if one or more of the system-protected files have changed since the specified date and time. If no system-protected files have changed, none will be backed up and no corresponding save set entry is made in the server's media index. However, on an incremental or level 1-9 backup of the VSS SYSTEM FILESET save set, if any system-protected files have changed since the specified time, all system-protected files are backed up. VSS SYSTEM FILESET components cannot be backed up or restored individually.

VSS SYSTEM SERVICES

Each component of the VSS SYSTEM SERVICES save set is always backed up at level full, even if another backup level is requested. VSS SYSTEM SERVICES components cannot be backed up individually, but they can be restored individually.

VSS USER DATA

Each component of the VSS USER DATA save set is always backed up at level full, even if another backup level is requested. VSS USER DATA save set components cannot be backed up individually, but they can be restored individually.

VSS OTHER

Each component of the VSS OTHER save set is always backed up at level full, even if another backup level is requested. VSS OTHER save set components cannot be backed up individually, but they can be restored individually.

VSS ASR DISK

The VSS ASR DISK save set is always backed up at level full, even if another backup level is requested. There are no individual components to back up or restore.

Save set consolidation

Save set consolidation merges a new level 1 backup with the last full backup of a save set to create a new full backup. Consolidation is a level full backup. The resulting save set is the same as a level full save set. Although a consolidated backup took place, there is no such thing as a consolidated save set.

Save set consolidation eliminates the need to perform full backups at regular intervals. After scheduling a save set consolidation backup, you only perform one full backup during the first scheduled consolidated backup cycle. Afterward, all subsequent backups of the consolidated save set are incremental backups.

Save set consolidation shifts the burden of backups to the NetWorker server, which reduces Client resource use and network traffic. This shift to the server also results in more frequent level saves, which results in fewer tapes to process in the event of a full recovery.

When working with large files, save set consolidation shortens the backup window by doing incremental saves, thus reducing the number of tape drives that are required during a recovery.

Note: If a save set consolidation is performed on a save set that has no existing full backup, the consolidation backup defaults to a level full backup and the browse and retention policy is set to one week. Once a full backup exists, subsequent consolidation backups are performed as a level 1 followed by consolidation with the existing full backup.

Requirements

Save set consolidation requires at least three attached devices: two for reading and one for writing.

Save set consolidation usage

Use save set consolidation if these conditions are present:

- ◆ A client is at a remote location and data transfer over the network to the server is a performance issue for either the network or the client.
- ◆ Either the network bandwidth is small, or large backups over the network are cost-prohibitive.
- ◆ You need to back up large file systems with little incremental data.
- ◆ The server has the necessary resources (a minimum of two volume drives and preferably three or more volume drives) and the workload capacity to consolidate full backups locally.

Note: Under the appropriate conditions, save set consolidation can free network bandwidth and Client resources. Used inappropriately, save set consolidation can lower performance, since it uses tape-to-tape transfer, which might be slower than the disk-to-tape data transfer that is used by backups.

Limitations of save set consolidation

These are some of the limitations that can cause the save set consolidation process to fail:

- ◆ Save sets cannot be consolidated when either the full or Level 1 save set contains a file larger than 2 GB.
- ◆ Raw disk file partitions are not eligible for consolidation.
- ◆ Database systems cannot be consolidated.
- ◆ Renamed and deleted directories cannot be consolidated. If incremental data contains renamed or deleted directories, the save set consolidation process will detect it and abort.

Additionally, do not use save set consolidation if any of the following conditions are present:

- ◆ The client is connected to the server over a fast network or is a local client, and the network data traffic generated by full backups is not a problem. In this case, save set consolidation will not produce a measurable benefit.
- ◆ The file systems being backed up are either not very large or they contain a large number of small files that are modified often.
- ◆ The incremental data usually contains a large amount of data, and the number of files that have changed since the last full backup is large compared to the total number of files in the file system.
- ◆ It is cost-prohibitive to allocate three tape drives for the exclusive use of the server while it consolidates the full backup.

Note: If a consolidated backup cannot be completed because of a system crash, tape drive errors, or other problem, data integrity is assured. The transactional log assists save set consolidation in putting back changes made to the online index.

Performing save set consolidation

You can schedule save set consolidation from the Administration window, or perform a manual consolidation from the command prompt.

Setting up save set consolidation on a schedule

To set up save set consolidation on a schedule:

1. Open the schedule to which save set consolidation will be applied. More information is available in [“Editing a schedule” on page 145](#).
2. Select the day the save set consolidation is to occur.
3. Right-click and select **Consolidate** from the **Set Level** menu.

Note: Renamed or deleted directories cannot be consolidated. If incremental data contains renamed or deleted directories, the save set consolidation aborts.

Perform a manual save set consolidation

You can invoke save set consolidation through two different command line programs:

- ◆ The **savegrp** program

The **savegrp** program must be used with the **-lc** option to indicate that the backup level is consolidated, or with a schedule that has a level consolidate on the schedule. This program automatically performs a level 1 backup, followed by the actual consolidation process.

- ◆ The **nsrssc** program

The **nsrssc** program completes the consolidation process. For the **nsrssc** program to be successful, a level 1 save set and a level full save set must already exist.

Note: When **nsrssc** is run from the command prompt, bootstrap information is not written to the media used for consolidation. As a result, you still need the original media for disaster recovery.

Both programs also offer other options to maximize the flexibility of save set consolidation. For more information about the **savegrp** and **nsrssc** commands, refer to the *EMC NetWorker Command Reference Guide* or the UNIX man pages.

Directing data from a consolidation backup to a specific pool

By default, save sets from a consolidation backup are written to whatever media is mounted for the group that was most recently backed up.

To direct consolidated save sets to a specific set of media:

1. Create a **Group** for consolidation backups, as described in [“Task 2: Set up a group for backup clients” on page 57](#).

2. Create a **Pool** for consolidation backups, as described in “[Creating a media pool](#)” on page 191.
3. In the **Pool** resource, select the group that was created in [step 1](#) as the value for the **Groups** attribute.
4. Edit the **Group** attribute in each **Client** resource that is to have consolidated backups, and assign the group that you created in [step 1](#).

Example 13 Consolidation of level 1 and full backups

On October 16, the level consolidated performs a level 1 backup, which backs up all the data that has changed since the last full backup. The level 1 backup is merged with the last full backup and builds a new level full backup. To recover from a disk crash on October 17, use the volume that was created on October 16.

[Figure 18 on page 156](#) illustrates how the NetWorker server merges a level 1 backup with an existing full level backup to create another level full backup.

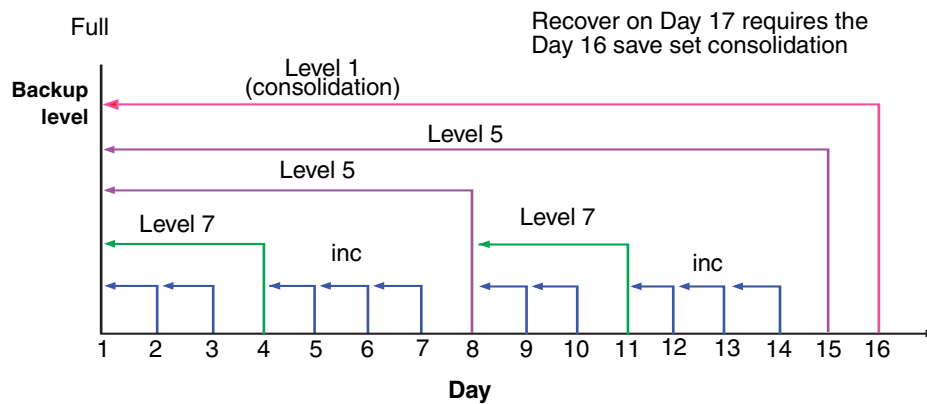

Figure 18 Consolidated backup

This chapter covers these topics:

- ◆ [About browse and retention policies](#) 158
- ◆ [Managing the data lifecycle](#) 162
- ◆ [Browse and retention policies for manual backups](#) 167
- ◆ [Modifying the browse and retention policy on a save set.....](#) 168

About browse and retention policies

The *browse policy* determines how long files are maintained in the client's file index on the NetWorker server. During the period of the browse policy, users can browse backed-up data from the NetWorker client computer, and select individual files or entire file systems for recovery. After the browse policy for a file is exceeded, the entry for that file is deleted.

The *retention policy* determines how long save set entries are maintained in the NetWorker server's media database. During the period of the retention policy, an entry for a save set cannot be accidentally overwritten.

For at least the period of the retention policy, you can recover a client's backed-up data by save set selection:

- ◆ No save set is considered recyclable until, at a minimum, it has exceeded its retention policy.
- ◆ No storage volume can be relabeled and overwritten until, at a minimum, all save sets on the storage volume (including save sets that depend on them) have exceeded their retention policies.

Entries for a save set can remain in the media database forever, long after the retention policy has expired. Entries are removed from the media database when these occur:

- ◆ Storage volume is relabeled.
- ◆ Entries are manually deleted.

The NetWorker server maintains one file index for each client computer (regardless of the number of Client resources configured for it), and one media database that tracks data from all clients and all save sets.

Browse policies

You can recover a file that has an entry in the client file index by using the NetWorker client computer. Users can browse and mark files, and initiate data recovery. The NetWorker server does not remove the entry for a file until all the save sets that are dependent on the file have also exceeded their browse policies. In general, the entries for a full backup that are older than the browse policy are not removed until one backup cycle has passed. This extra time ensures that you can reconstruct a file to any point in time included in the browse policy period.

The example in this section demonstrates how a browse policy affects data availability in the client file index. [“Schedules” on page 140](#) provides information about schedules and [“Backup levels” on page 147](#) provides information about backup levels

Example 14 One-week browse policy

In [Figure 19 on page 159](#), both the backup cycle and the browse policy are set at one week. A backup cycle is the length of time between full backups. Entries for the first full backup on October 1 remain in the client file index until all the dependent

incremental and level 5 backups exceed the one-week browse policy. The full backup performed on October 1 is not removed until October 15, when the incremental and level 5 backups that depend on the full backup expire.

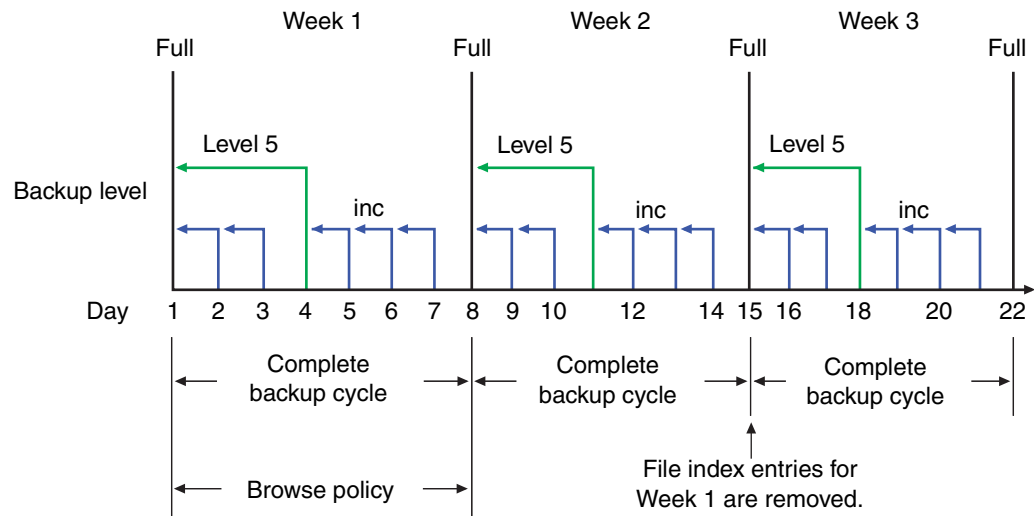

Figure 19 One-week browse policy

To further illustrate, suppose that on October 12, you recover information that is backed up on October 5. The backup performed on October 5 is an incremental backup that is dependent on the October 4 backup, which is a level 5 backup. The October 4 (level 5) backup, in turn, is dependent on the full backup performed on October 1.

The entry for the full backup performed on October 1 must remain in the client file index for a period of time equal to the sum of the following:

- ◆ The browse policy (one week)
- ◆ One complete backup cycle (one additional week)

That is, it must remain in the client file index until the level 5 backup on October 4 and all incremental backups dependent on the full backup pass their browse policy. In [Figure 19 on page 159](#), entries from the Week 1 backup cycle are removed from the client file index on October 15.

Example 15 Two-week browse policy

In [Figure 20 on page 160](#), the browse policy is two weeks, which is twice as long as the backup cycle (one week). In this example, on October 18 a user can still find browsable entries in the client file index from backups created on October 4. The backup performed on October 5 is an incremental backup dependent on the October 4 backup, which is a level 5 backup. The October 4 (level 5) backup, in turn, is dependent on the full backup performed on October 1.

The full backup performed on October 1, and the incremental and level backups that depend on it, must remain in the client file index for a period of time equal to the combination of the following:

- ◆ The browse policy (two weeks)
- ◆ One complete backup cycle (one additional week)

In this example, entries for the Week 1 backup cycle are not removed from the client index until October 22.

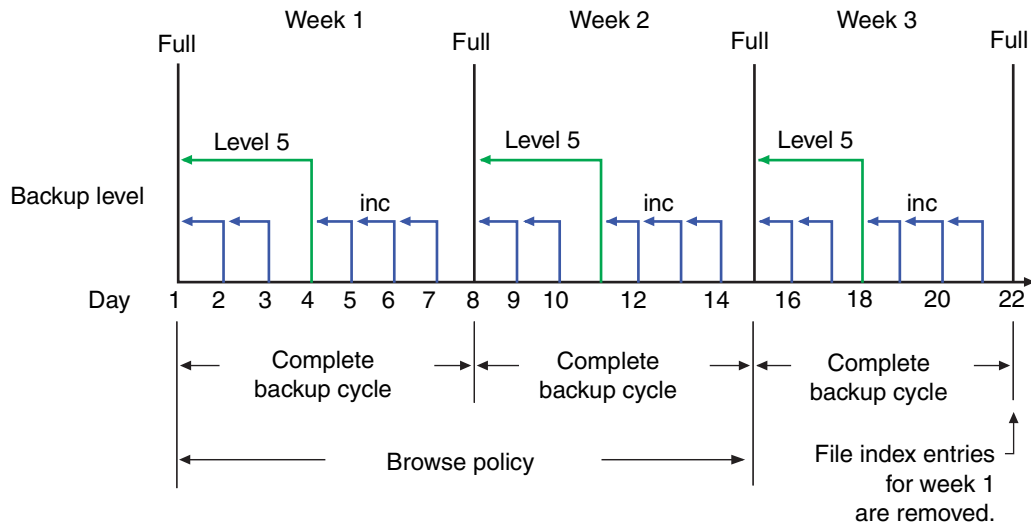

Figure 20 Two-week browse policy

Retention policies

The NetWorker media retention policy specifies a period during which backed-up data is protected from an accidental overwrite. After the retention period is exceeded, the save set is eligible to change its status from recoverable to recyclable. The term recyclable means “eligible for recycling.” The save set’s status, however, does not change to recyclable until it, and all the save sets that depend on it, have passed their retention policy. The NetWorker server keeps track of save set dependencies regardless of whether the dependent save sets are stored on the same or different volumes. The expiration of a save set’s retention policy does not remove the save set’s entries from the media database.

A storage volume becomes recyclable when:

- ◆ The retention policy for every save set on a volume expires.
- ◆ The status for every save set on a volume changes from recoverable to recyclable.

Since a volume can contain save sets from multiple backup sessions, all with different retention policies, the mode of a volume might not change to recyclable for a long time. All the data on the volume remains available for recovery by using either save set **recover** or the **scanner** program. All the entries for recyclable save sets remain in the media database.

If a volume contains one or more deduplication save sets, the resource for the deduplication node that was used to create the backup must exist when the save sets pass their retention time. If the resource for the deduplication node has been deleted, the volume cannot be made recyclable or relabeled. Furthermore, when deduplication save sets pass their retention time, the NetWorker server will begin the process of deleting the deduplicated data from the deduplication node. Therefore, deduplication data may not be recoverable using the scanner program once the deduplication save set has passed its retention time.

The change in status to recyclable means that the volume can be overwritten if conditions are right. The volume can be relabeled under the following conditions:

- ◆ The volume is placed in an autochanger or mounted in a stand-alone device.
- ◆ The Auto Media Management attribute in the Device resource is enabled.

The existing data is nonrecoverable after the volume is relabeled. [“Auto Media Management” on page 288](#) provides information about the Auto Media Management attribute.

Save set entries are also removed from the media database when they are manually deleted. However, the data on that volume is still available for recovery by using the **scanner** program. The **scanner** program retrieves the information needed to re-create entries in either the client file index, in the media database, or in both places:

- ◆ If you re-create the entries in the client file index, a user with the proper permissions can recover data by using the NetWorker client computer.
- ◆ If you re-create the save set’s entries in the media database, a UNIX root user or a member of the Windows Administrators group can recover data by using save set recovery.

[“Restore a save set entry in the online indexes” on page 338](#) provides more information about re-creating entries in the client file index or the media database.

Note: If only one full browsable saveset backup exists, then its browse policy is equal to its retention policy.

Example 16 Three-week retention policy

[Figure 21](#) illustrates how a retention policy works. In this example, the backup cycle is set at one week and the retention policy is set at three weeks.

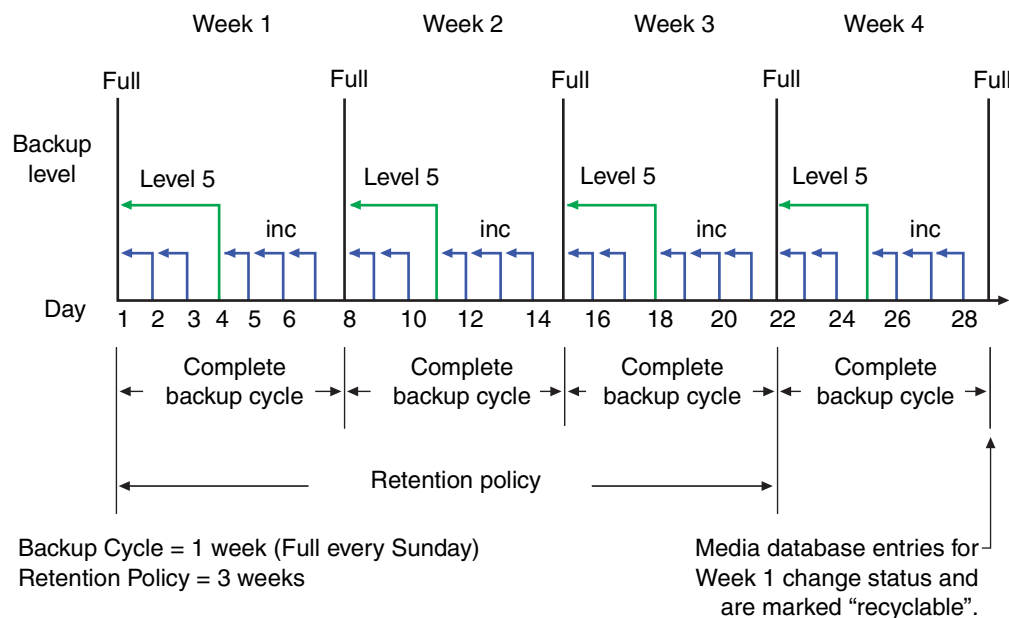

Figure 21 One-week backup cycle and three-week retention policy

The save set entries for Week 1 have passed their browse policy and retention policy, but they remain available for recovery by using the **scanner** program or via a save set recovery until you relabel the volume. When all the save set entries on a volume change status to recyclable, the volume mode changes from full or appendable to recyclable, and the volume is ready to be relabeled for reuse.

Note: Once a volume is relabeled, data on the volume cannot be recovered.

For more information on these topics, see these sections:

- ◆ [“Viewing volume status information” on page 290](#)
- ◆ [“Schedules” on page 140](#)
- ◆ [“Backup levels” on page 147](#)

Retention policies for client file index save sets

The client file indexes that reside on the NetWorker server are backed up as are any other files. However, the retention policy for these files is calculated differently than for other files. The retention policy for a client file index is based on the retention policy that is specified for the NetWorker client to which the client file index corresponds. For example, if NetWorker client *jupiter* has a retention policy of seven years, then the client file index that corresponds to *jupiter* will also have a retention policy of seven years regardless of any retention policy that may be set up for the NetWorker server. This ensures that if a NetWorker client is recovered, the corresponding client file index can also be recovered.

Retention policies and media pools

A retention policy can also be specified for a media pool. If the retention policy is specified for a media pool as well as the client, the NetWorker software will the longer of the two policies.

Assigning a retention policy to a clone pool has special implications. When a retention policy is specified in a clone pool, all save sets that are directed to the clone pool take on the retention policy of the clone pool regardless of the retention policy of the save set client. [“Specifying browse and retention policies for clone data” on page 226](#) provides more information.

When browse and retention policies are specified with a command line program, such as **save -w -y**, the browse and retention policies are taken from that program. [“Browse and retention policies for manual backups” on page 167](#) provides more information.

Managing the data lifecycle

Browse and retention policies control the growth of the client file index and the media database, and how long data remains available for recovery.

[Figure 22 on page 163](#) traces the data lifecycle through the client file index and the media database. In the example, the entries for the September 1 through September 7 backup cycle remain in the client index for one month (the browse policy), plus the length of a full backup cycle (one week), to ensure that all dependent entries pass their browse policies. In this case, the file index entries for the September 1 through September 7 backup cycle are removed on October 13. Since the entries exist in the client file index, you can browse and recover the data through the NetWorker client

computer. As long as the save set's file entries remain in the client file index, the status of the source save set is browsable. After the save set status changes from browsable to recoverable, you must know the full path to the file in order to recover it directly.

The status for each save set backed up during the September 1 through September 7 cycle remains recoverable until their retention policies expire and all the dependent save sets exceed their retention policies. In this case, the entries from the September 1 through September 7 backup cycle change from recoverable to recyclable on December 8. When all of the save set entries on a volume change status to recyclable, the mode of the volume changes to recyclable and the volume can be overwritten.

While a save set is either recoverable or recyclable, you can recover any save set by using either the save set recovery procedure or the **scanner** program. Alternatively, you can use the **scanner** program to re-create a save set's entries in the client file index, which enables file recovery directly from the NetWorker client computer. "Recovering by save set selection" on page 325 and "Restore a save set entry in the online indexes" on page 338 provide more information.

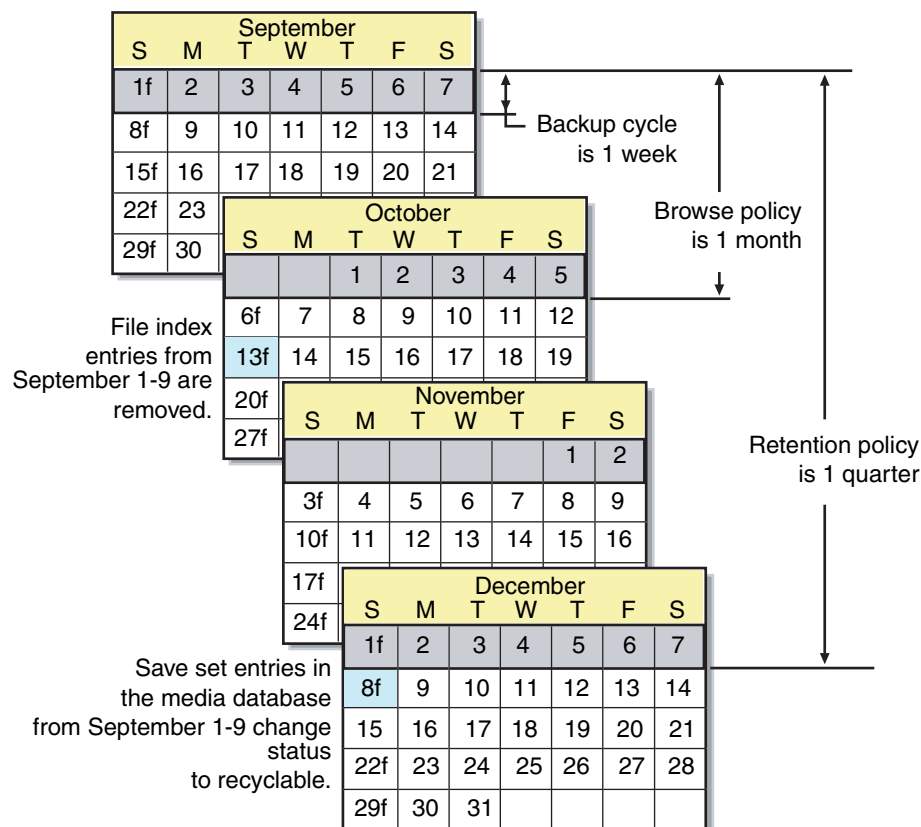

Figure 22 Data lifecycle in the client index and the media database

On October 13, all data entries from September 1 to September 7 are removed from the client file index. On December 8, the save set entries from September 1 to September 7 in the media database change status from recoverable to recyclable. After all save sets on a volume change status from recoverable to recyclable, the volume mode changes to recyclable. After the volume is relabeled, all existing data on the volume is unavailable for recovery.

Note: When you relabel a volume for reuse within the same *pool*, the volume identification (the volume name as it appears on the volume label) remains unchanged. Even though the volume has the same label, information required by the NetWorker server to locate and restore data on the volume is destroyed. All existing data is inaccessible and will be overwritten.

Assigning multiple policies to a single client

Identical versions of a client and save set combination can have a different set of browse and retention policies assigned for each different backup group to which it belongs. If you create an identical Client resource with the same name and save set values, but assign it to a different backup group, you can designate a different set of browse and retention policies. The NetWorker server employs the Browse Policy and Retention Policy attributes that correspond to the unique combination of the Client resource's Name, Save Set, and Group attributes.

Example 17 Assigning different policies for an identical client

You have a Client resource for the host saturn. The Client resource has a save set value of All and is assigned to backup group general. The browse policy is weekly and the retention policy is monthly. You create a copy of the Client resource for saturn, but assign it to the backup group special. This version of saturn has a browse policy of Weekly and a retention policy of yearly.

- ◆ If the group special is backed up, then the weekly and yearly policies are applied.
- ◆ If the group general is backed up, then the policies weekly and monthly are used.

Preconfigured policies

NetWorker software contains these preconfigured browse policies:

- ◆ Day
- ◆ Week
- ◆ Month
- ◆ Quarter
- ◆ Year
- ◆ Decade

You can use these preconfigured policies, or customize policies to best suit data storage needs. Create the customized policy before you configure the client. Otherwise, the policy name does not appear in the Client dialog box as an option.

[“Task 3: Set up policies for quick access and long term storage” on page 57](#) provides information about creating a policy.

Editing a policy

Note: You *cannot* change the name of a policy. To rename a policy, delete the current policy and create a new one.

To edit a policy:

1. In the **Administration** window, click **Configuration**.
2. In the expanded left pane, select **Policies**.
3. In the right pane, select the policy to edit.
4. From the **File** menu, select **Properties**.
5. Make any necessary changes in the **Properties** dialog box and click **OK**.

Delete a policy

Note: Preconfigured policies cannot be deleted. For more information, see [“Preconfigured policies” on page 164](#).

To delete a policy:

1. In the **Administration** window, click **Configuration**.
2. In the expanded left pane, select **Policies**.
3. In the right pane, select the policy to delete.
4. From the **File** menu, select **Delete**.
5. When prompted, click **Yes** to confirm the deletion.

Snapshot policies

A snapshot policy is required to perform backups with the NetWorker PowerSnap™ Module software. This policy determines how many snapshots are created, retained, and backed up to permanent storage. You can specify a preconfigured policy or create a custom snapshot policy.

The snapshot policy works in conjunction with the Interval attribute of the Group resource. The value for the Interval attribute must be set low enough that the specified number of snapshots can be created in the 24-hour period. For example, to create four snapshots, the Interval value must be set to six hours or less.

For more information on the NetWorker PowerSnap Module software and creating a snapshot policy, refer to the EMC PowerSnap Module documentation. The *EMC NetWorker Module for Microsoft Applications Administration Guide* provides information about creating a snapshot policy for the VSS Client.

Working with snapshot policies

This section provides information about preconfigured snapshot policies, as well as instructions for creating, editing, and deleting snapshot policies.

Preconfigured snapshot policies

If a new customized snapshot policy is *not* manually created, the NetWorker software provides two preconfigured policies that can be used with the PowerSnap Module software:

- ◆ Serverless

With the Serverless snapshot policy, a single snapshot is taken per day. The data is then backed up to traditional tape and the snapshot is deleted.

- ◆ Daily

With the Daily snapshot policy, eight snapshots are taken in a single day. The data in the first snapshot is backed up to tape. Each snapshot has an expiration policy of 24 hours.

Note: Neither preconfigured snapshot policy may be deleted.

Creating a snapshot policy

To create a snapshot policy:

1. In the **Administration** window, click **Configuration**.
2. In the expanded left pane, select **Snapshot Policies**.
3. From the **File** menu, select **New**.
4. In the **Create Snapshot Policy** dialog box, type a name for the snapshot policy in the **Name** attribute and complete other attributes as appropriate.

Note: For information about how to complete the attributes for a snapshot policy, refer to the EMC NetWorker PowerSnap Module documentation.

5. Click **OK**.

Edit a snapshot policy

To edit a policy:

1. In the **Administration** window, click **Configuration**.
2. In the expanded left pane, select **Snapshot Policies**.
3. In the right pane, select the snapshot policy to edit.
4. From the **File** menu, select **Properties**.
5. Make any necessary changes in the **Properties** dialog box and click **OK**.

Copying a snapshot policy

To copy a snapshot policy resource:

1. In the **Administration** window, click **Configuration**.
2. In the left pane, select **Snapshot Policies**.
3. In the right pane, select the **Snapshot Policy** resource to copy.

4. From the **Edit** menu, select **Copy**. The **Create Snapshot Policy** dialog box appears.
5. Type the name for the new **Snapshot Policy** resource in the **Name** attribute, edit any other attributes as appropriate, and click **OK**.

Delete a snapshot policy

To delete a snapshot policy:

1. In the **Administration** window, click **Configuration**.
2. In the expanded left pane, select **Snapshot Policies**.
3. In the right pane, select the snapshot policy to delete.
4. From the **File** menu, select **Delete**.
5. When prompted, click **Yes** to confirm the deletion.

Browse and retention policies for manual backups

If a browse or retention policy is specified with a manual backup from the command prompt, the browse or retention policy takes effect for all of the save sets included in the manual backup. Specify browse and retention policies with a manual backup from the command prompt by using the **save -w -y** command. Both the browse and the retention policies must be entered in time and date formats accepted by the **nsr_getdate** program. The *EMC NetWorker Command Reference Guide* or the UNIX man pages provide more information about **save** and **nsr_getdate**.

If a browse or retention policy is *not* specified for a manual backup, the policies are determined as follows:

◆ Browse policy

The save sets included in a manual backup adopt the browse policy of the Client resource. If there are multiple Client resources for the NetWorker host, the Client resource with the longest browse time is adopted. For example, if there are three Client resources for the NetWorker client mars, each with one of these browse periods:

- One week
- One month
- One year

A manual backup of mars adopts a browse policy of one year.

◆ Retention Policy

The save sets included in a manual backup adopt the retention policy of the Client resource according to the same rules that were described previously for browse policies. However, if a retention policy is set up for the media pool to which the backup is directed, the retention policy will be the longer of either:

- The Client resource retention policy
- The media pool retention policy

There are special considerations for retention policies and clone data. [“Specifying browse and retention policies for clone data” on page 226](#) provides more information.

Modifying the browse and retention policy on a save set

Use the **nsrmm** program to modify the browse and retention policy of a save set after the backup has occurred. Use **nsrmm** with these options:

- ◆ **-e** *retention_time* – updates retention time
- ◆ **-w** *browse_time* – updates browse time

Use the **-e** and **-w** options with the **nsrmm** option **-S** (to specify a save set ID).

Note: The retention time must be later than the browse time, and the browse time must be later than the *insertion_time*. The insertion time is the time that the save set record was most recently introduced into the save set database.

When the **-e** and **-w** options are used with **nsrmm**, these must be true:

- ◆ Retention-time is greater than the browse-time.
- ◆ Browse-time is greater than the insertion-time.

Both the browse and the retention policies must be entered in time and date formats accepted by the **nsr_getdate** program. The *EMC NetWorker Command Reference Guide* or the UNIX man pages provide more information about **nsrmm** and **nsr_getdate**.

Example 18 Changing browse and retention policies with nsrmm

The examples in this section use **nsrmm** to change browse and retention policies:

- ◆ Change the retention time to midnight, January 1, 2016. Change the browse time to midnight, January 1, 2012:

```
nsrmm -S 3315861249 -e "01/01/09 23:59:59" -w "01/01/08 23:59:59"
```

- ◆ Change the browse time to six months from the current date and time:

```
nsrmm -S 5315861249 -w "6 months"
```

- ◆ Change the retention time to two years from the current date and time:

```
nsrmm -S 3315861249 -e "2 years"
```

Reports on browse and retention policies for save sets

The **mminfo** command can be used with the **-p** option to display a report on the browse and retention times for save sets. The *EMC NetWorker Command Reference Guide* or the UNIX man pages provide more information about **mminfo**.

This chapter covers these topics:

◆ Directives overview	170
◆ Types of local and global directives.....	170
◆ Creating a global directive resource	170
◆ Editing a global directive resource	171
◆ Deleting a global directive resource	171
◆ Copying a global directive resource	171
◆ Applying directives.....	172
◆ Local directives within the NetWorker User program	173
◆ Preconfigured global directive resources.....	174
◆ Format of directive statements	176

Directives overview

Directives are resources that contains special instructions that control how the NetWorker server processes files and directories during backup and recovery. NetWorker administrators can create directives to customize the NetWorker software to your specific needs, maximize the efficiency of backups, and apply special handling to individual files or directories.

Note: If deduplication is used for a client, directives cannot be applied.

Types of local and global directives

There are three types of directives.

Global directives

Administrators can create global directives by using the **NetWorker Administrator** program. These directives are stored as resources on the NetWorker server, and can be selectively applied to individual clients by using the Directive attribute of the Client resource.

NetWorker User local directives (Windows only)

On clients that run Microsoft Windows, users with local Windows Administrator or Backup Operator privileges can create local directives by using the NetWorker User program. These directives are stored on the client in a file named `networkr.cfg`, and are applied throughout the client's file systems during scheduled backups (or **save** operations that do not include the **-i** option).

Local directive files

Users can create local directive files named `nsr.dir` (Windows) or `.nsr` (UNIX) anywhere on a client file system that they have permission to create files. The directives these files apply only to the immediate data within the path where the directive file is located.

Creating a global directive resource

[“Format of directive statements” on page 176](#) provides instructions on the syntax to use when creating directives.

To create a global directive:

1. From the **Administration** window, click **Configuration**.
2. In the expanded left pane, select **Directives**.
3. From the **File** menu, select **New**.
4. In the **Name** attribute, type a name for the new directive.

5. In the **Comment** attribute, type a description of the directive.
6. In the **Directive** attribute, type one or more directives.
7. Click **OK**.

The directive can now be applied to a NetWorker Client resource. [Example 19, "Applying a global directive"](#) provides more information.

Editing a global directive resource

Note: A directive name cannot be changed, the directive must be deleted and a new one created with a new name.

To edit a global directive:

1. From the **Administration** window, click **Configuration**.
2. In the expanded left pane, select **Directives**.
3. In the right pane, select the directive.
4. From the **File** menu, select **Properties**.
5. In the **Directive** attribute, modify the directive as necessary and then click **OK**.

Deleting a global directive resource

Note: You cannot delete preconfigured directives or any directives currently applied to a Client resource.

To delete a global directive:

1. From the **Administration** window, click **Configuration**.
2. In the expanded left pane, select **Directives**.
3. In the right pane, select the directive to delete.
4. From the **File** menu, select **Delete**.
5. Click **Yes** to confirm the deletion.

Copying a global directive resource

To copy a global directive:

1. From the **Administration** window, click **Configuration**.
2. In the expanded left pane, select **Directives**.
3. In the right pane, select the directive to copy.
4. From the **Edit** menu, select **Copy**.

A copy of the directive is created.

5. In the **Name** attribute specify a name for the directive.
6. In **Directive** attribute, modify the directive as necessary and then click **OK**.

Applying directives

This section contains some basic examples of global and local directives, and describes how to apply them to NetWorker clients.

Note: If deduplication is used for a client, directives cannot be applied.

Example 19 Applying a global directive

This example shows how to use a global directive to skip all *.tmp files in a particular directory for a particular NetWorker client.

1. Create a global directive by using the appropriate format:
 - On Windows, skip all *.tmp files in the C:\mydir directory:

```
<<"C:\MYDIR">>
skip: *.tmp
```
 - On UNIX, skip all *.tmp files in the /mydir directory:

```
<</mydir>>
skip: *.tmp
```
2. Apply the directive to the appropriate NetWorker Client resource:
 - a. From the **Administration** window, click **Configuration**.
 - b. In the left pane, click **Clients**.
 - c. In the right pane, select a client.
 - d. From the **File** menu, select **Properties**.
 - e. From the **Directives** attribute list, select a directive and then click **OK**.

When a scheduled backup is performed on the NetWorker client, all files that match the *.tmp pattern in the specified directories will be skipped.

Example 20 Applying a NetWorker User program local directive (Windows only)

This example shows how to use a Windows local directive to skip all *.tmp files in the C:\mydir directory on a particular NetWorker client.

Using the NetWorker User program, create a local directive. The directive is saved in the networkr.cfg file in this format:

```
<<"C:\mydir">>
skip: *.tmp
```

When a scheduled backup is performed on the NetWorker client, all files that match the *.tmp pattern in the C:\mydir directory will be skipped.

[“Local directives within the NetWorker User program” on page 173](#) provides information on creating local directives.

Example 21 Applying a local file directive

This example shows how to use a local file directive to skip all *.tmp files in a particular directory for a particular NetWorker client. When a scheduled backup is performed on the NetWorker client, all files that match the *.tmp pattern in the specified directory will be skipped.

On Windows, skip all *.tmp files in the C:\mydir directory:

1. Use a text editor to create a file named nsr.dir and type this directive in the file:
skip: *.tmp
2. Place the nsr.dir file in the C:\mydir directory on the NetWorker client.

Note: To create directive files on a client that is running Microsoft Windows, an authenticated user must have the appropriate permissions to create files either within the root of a volume, or in a folder within the volume.

On UNIX, skip all *.tmp files in the /mydir directory:

1. Use a text editor to create a file named .nsr and type this directive in the file:
skip: *.tmp
2. Place the .nsr file in the /mydir directory on the NetWorker client.

Order of precedence of global and local directives

If there is a conflict between directives, global directives are enforced over local directives. And on Windows hosts, NetWorker User program local directives are enforced over local directive files (nsr.dir files).

Local directives within the NetWorker User program

On Windows, users can create local directives with the NetWorker User program. These directives are saved in a file named networkr.cfg.

When you perform a manual backup from the NetWorker User program, only local directives that were created with the NetWorker User program are enforced. Global directives and local directive files (nsr.dir files) are *not* enforced. However, all local directives are enforced when a NetWorker **save** without the **-i** option is run at the command-prompt.

NetWorker User program local directives are also enforced during scheduled backups and archive operations.

Set up a NetWorker User program local directive

To set up a User program local directive:

1. Log in to the client computer as a member of either the local **Windows Administrators** or **Backup Operators Windows** security group.
2. Start the **NetWorker User Program**.
3. From the **Options** menu, select **Local Backup Directives**.
4. Set the local directive for each data item. You can clear data items in order to exclude them from scheduled backups, and select items for password-protection, encryption, and compression. This applies for both manual and scheduled saves.

Note: If password-protection or encryption is selected, the password must be specified first. [“Encrypting backup data” on page 77](#) provides information about setting a password.

5. From the **File** menu, select **Save Backup Directives** to save changes.

Depending on user privileges and OS version, the User program creates networkr.cfg in one of these locations:

- If you are logged on with local Windows Administrator or Backup Operator privileges, networkr.cfg is created in the root of the system volume (usually C:\).
- If you are *not* logged on with local Windows Administrator or Backup Operator privileges, NETWORKR.CFG is created in %SystemDrive%\Documents and Settings\User_name\Application Data\Legato

Note: The Application Data directories are hidden by default. To view these directories by using Windows Explorer, select **Tools > Folder Options**. On the **View** tab of the **View Options** dialog box, select the **Show hidden files and folders** option.

Preconfigured global directive resources

The NetWorker software comes with a number of preconfigured global Directive resources. All preconfigured Directive resources can be modified, but they cannot be deleted.

Table 24 lists the preconfigured directives and their descriptions.

Table 24 Preconfigured directives (1 of 3)

Directive resource	Description
AES	Encrypts backup data with the aes ASM, which provides 256-bit data encryption. For more information about encrypting backup data, see “Encrypting backup data” on page 77 .
DOS standard	Legacy resource that is used to back up Microsoft Windows 95 and Windows 98 clients. By default, this resource has no directives.
DOS with compression	Legacy resource that is used to back up and compress Microsoft Windows 95 and Windows 98 clients. Applies the compressasm ASM to all files.
Mac OS with compression	Contains the same set of directives as the Mac OS standard directive, along with applying the compressasm ASM to specific directories.

Table 24 Preconfigured directives (2 of 3)

Directive resource	Description
Mac OS standard	<p>Contains a set of directives used to back up standard Mac OS clients. Applies these ASMs:</p> <ul style="list-style-type: none"> The skip ASM is applied to these files and directories: <ul style="list-style-type: none"> /Desktop DB /Desktop DF /cores /VM_Storage /TheVolumeSettingsFolder /private/var/db/netinfo /private/var/db/openldap /private/tmp /.Spotlight-V100 /.hotfiles.btree The allow save environment keyword is applied to the /nsr directory to ensure that local directives in /nsr and subsequent subdirectories are applied. The logasm ASM is applied to the /nsr/logs and /var directories. The swapasm ASM is applied to the /private/var/vm
NetWare standard	Is used to back up NetWare clients. By default, this resource has no directives.
NetWare with compression	Is used to back up and compress NetWare clients. Applies the compressasm ASM to all files.
NT standard	Is used to back up Windows clients. By default, this resource has no directives.
NT with compression	Used to back up and compress Windows clients. It applies the compressasm ASM to all files.
UNIX standard	<p>Contains a set of directives used to back up standard UNIX clients. Applies these ASMs:</p> <ul style="list-style-type: none"> The skip ASM is applied to the tmp_mnt directory. The skip ASM is applied to core files on the file system. The allow save environment keyword is applied to the /nsr directory to ensure that local directives in /nsr and subsequent subdirectories are applied. The skip ASM is applied to the /tmp directory. The swapasm ASM is applied to the /export/swap directory. If swap files are located in a different directory, modify this directive to use the appropriate directory. The logasm ASM is applied to the /nsr/logs, /var, /usr/adm, and /usr/spool directories. You can apply this ASM to other directories as well. The mailasm ASM is applied to the /usr/spool/mail and /usr/mail directories. If email files are located in different directories, modify these directives to use the appropriate locations.
UNIX with compression	<p>Contains the same set of directives as the UNIX standard directive, along with applying the compressasm ASM to all files.</p> <p>Note: This directive is only applied to save sets that contain directories. If the save set is defined by using a filename, this directive will not be applied.</p>

Table 24 Preconfigured directives (3 of 3)

Directive resource	Description
VCB directives	<p>VCB directives are valid for backing up virtual machines using the VCB methodology. This directive is supported in the following scenarios:</p> <ul style="list-style-type: none"> • When file level incremental backups are performed instead of FULL image level backups. • When FULL file level or incremental file level backups are performed when the save set is ALLVMFS. <p>The vcb directive skips the following files and folders:</p> <ul style="list-style-type: none"> • pagefile.sys • hiberfil.sys (Hibernation file) • WINDOWS\system folder • WINDOWS\System32 folder

Format of directive statements

The format of a directives uses three primary types of statements:

- ◆ Directory specifications
- ◆ Application-Specific Module (ASM) specifications
- ◆ Save environment keywords

Comments can be included in directives as well. Any text after a hash (#) character is treated as a comment.

Note: For more information about directive formats, refer to the `nsr` and `nsr_directive` information in the *EMC NetWorker Command Reference Guide* or the UNIX man pages.

Directory specifications

Directory specifications indicate the highest-level directory to which these ASMs apply. Be aware of the following considerations when adding directory specifications:

- ◆ You cannot use wildcards in directory specifications.
- ◆ When multiple directory specifications are used, directives that follow a directory specification apply to that directory until the next directory specification.
- ◆ Mount points, including nested mount points, must have their own directory specification.
- ◆ For directives applied to clients on Windows systems, pathnames are not case-sensitive. If there is a colon (:) in the pathname, the entire path must be enclosed in quotation marks.

The format for a directory specification is:

```
<<directory>>
```

- ◆ On Windows:

```
<<"C:\BIN">>
asm
<<"C:\TEMP">>
asm
```

- ◆ On UNIX:

```
<<" /etc">>
asm
<<" /tmp">>
asm
```

ASM specifications

ASMs specify the action to take on one or more files. The syntax for an ASM specification is:

```
[+]asm: argument
```

where:

- ◆ The optional plus sign (+) indicates that the directive applies to both the current directory and all subdirectories.
- ◆ *asm* is the name of the ASM to be executed
- ◆ *argument* is a list of names (files or directories) that are acted upon by the ASM. The argument can include multiple names, separated by spaces, and can also specify wildcards. The argument can contain names that are in the current directory only. Subdirectories cannot be specified in the argument.

If an ASM or argument name includes a space, enclose the name or argument in double quotes. “[Save environment keywords](#)” on page 177 provides a description of available ASMs and examples.

Note: For directives applied to clients on Microsoft Windows systems, filenames are case-sensitive.

Using wildcards in ASM specifications

Wildcards can be used in ASM specifications to replace a single character or string of characters. Standard shell command interpreter filematching patterns are supported.

On UNIX systems, when applying a directive to all files, including hidden files, use * .* (insert a space after the first asterisk).

Save environment keywords

Save environment keywords are used to control how the current ASM and subsequent ASMs that apply to the current directory and subdirectories will be applied.

[Table 25 on page 177](#) lists the three save environment keywords.

Table 25 Save environment keywords (1 of 2)

Keyword	Instruction	Example
forget	Instructs the NetWorker server to no longer apply inherited directives (those directives that begin with a +).	<pre><<G: \SRC>> +skip: *.o <<G: \SRC\SYS>> forget</pre> <p>This uses the skip ASM to instruct the NetWorker server to skip all files named *.o in the SRC directory and all subdirectories. It then uses the forget keyword to instruct the server to not apply the skip ASM to the SYS subdirectory.</p>

Table 25 Save environment keywords (2 of 2)

Keyword	Instruction	Example
ignore	Instructs the NetWorker server to ignore all directives applied to the subdirectories below the current directory.	To override any local directives set in users' home directories, type: <pre><<G:\HOME>> ignore</pre>
allow	Used in subdirectories that currently have the ignore keyword applied to them, and overrides the ignore.	Building on the preceding example for the ignore keyword, to allow directives in the G:\HOME\DOC directory to be applied, type: <pre><<G:\HOME>> ignore <<G:\HOME\DOC>> allow</pre>

Application Specific Modules (ASMs)

Directives use Application Specific Modules (ASMs) to process files and directories. ASMs are programs that operate within the NetWorker environment to perform various tasks during backup and recovery. For example, the **compressasm** program instructs the NetWorker server to compress data during backup.

ASMs are specified in a directive and are then executed during the backup of client data. Directives can contain one or more ASMs. [Table 26](#) describes the NetWorker ASMs.

Table 26 NetWorker ASMs (1 of 3)

ASM name	Description	Example
aes	Encrypts backup data when included in a global directive that is associated with a Client resource. "Encrypting backup data" on page 77 has information about using the AES ASM.	+aes: *
always	Always backs up the specified files, independent of the change time of the file, and ignores the scheduled level. This ASM can be used to ensure that important client files that change constantly are always fully backed up.	always: *.c
compressasm	Compresses files so that they use less network bandwidth and fewer volumes. This ASM does not compress directories. The amount of compression achieved is data-dependent. This ASM uses considerable amounts of CPU resources, so its benefits could be limited on low-powered systems. If your storage device compresses data, you can also apply this ASM. However, the additional compression might actually result in slightly more data being written to tape.	+compressasm: .
holey	Handles holes or blocks of zeros when backing up files and preserves these holes during recovery. This ASM is normally applied automatically and does not need to be specified.	+holey: *
logasm	Instructs the NetWorker server to not generate errors when the files specified by this ASM are in use. This ASM is useful for files involved in logging, and other similar files that might change during a backup operation.	+logasm: *.log

Table 26 NetWorker ASMs (2 of 3)

ASM name	Description	Example
mailasm	Uses mail-style file locking and maintains the access time of a file, preserving "new mail has arrived" flag on most mail handlers.	+mailasm: *.mbx
mtimeasm	Backs up files by using the modification time, rather than the inode change time, to determine which files should be backed up. The modification time is the last time the file's contents were modified, while the inode change time is the last time the file's mode, owner, or link count was changed.	mtimeasm: *.log
nsrindexasm	Used to recover from NetWorker file index backups performed by NetWorker servers prior to release 6.0. During recovery from these older index backups, nsrindexasm is invoked automatically by nsrck and mmrecov .	Not applicable
nsrmmdbasm	Used to process the media database. Normally, nsrmmdbasm is invoked automatically by savegrp and mmrecov , and should not be used in NetWorker directives.	Not applicable
null	Does not back up the specified files, but does back up the directory containing the files so entries for the files get added to the online indexes. The NetWorker server uses this ASM to back up the online indexes during a scheduled backup.	+null: *.tmp
nullasm	Another name for the null ASM, used for backward compatibility.	See null .
posixcrcasm	Calculates a 32-bit cyclic redundancy check (CRC) for a file during backup. This CRC is stored along with the file and is verified when the file is restored. No verification occurs during the backup itself. With this ASM, it is possible to validate a file at restore time, but it does not provide a way to correct any detected errors.	posixcrcasm: *.*?
rawasm	Specifies the back up of UNIX raw disk partitions. The /dev entries (block and character-special files) and their associated raw disk partition data is backed up. On some systems, /dev entries are symbolic links to device specific names. Unlike other ASMs, this ASM follows symlinks, allowing the shorter /dev name to be configured. "Precautions when using rawasm to back up UNIX raw partitions" on page 180 provides more information.	rawasm: /dev/oracle1
skip	Omits files and directories from the backup, and does not place the directory or filename in the online index. In the example given, all files and directories with the name temp will be omitted from the backup.	+skip: temp

Table 26 NetWorker ASMs (3 of 3)

ASM name	Description	Example
swapasm	Does not back up actual file data, but re-creates a zero-filled file of the correct size on recovery. This ASM is used on systems where the swapping device is a swap file that must be recovered with the correct size, but the contents of the swap file are not important and do not need to be backed up or restored.	swapasm: compression.doc
xlateasm	Translates file data so that data backed up is not immediately recognizable	xlateasm: *.*

Precautions when using rawasm to back up UNIX raw partitions

One can specify the **rawasm** directive to back up raw disk partitions on UNIX. However, if the raw partition contains data managed by an active database management system (DBMS), ensure that the partition is offline and the database manager is shutdown. For greater flexibility when backing up partitions that contain data managed by a DBMS, use a NetWorker Module application.

Similarly, if **rawasm** is used to save a partition containing a UNIX file system, the file system must be unmounted or mounted read-only to obtain a consistent backup.

Note: Do not specify the **rawasm** directive to backup or recover raw partitions on Windows. [“Backing up raw partitions on Windows” on page 95](#) provides more information.

Using rawasm to recover a UNIX raw partition

When recovering data, **rawasm** requires that the file system node for the raw device exist prior to the recovery. This protects against the recovery of a /dev entry and the overwriting of data on a reconfigured disk. You can create the /dev entry, having it refer to a different raw partition, and force an overwrite if needed. If you create the /dev entry as a symbolic link, the data is recovered to the target of the symbolic link.

Recovery of a raw partition must occur on a system configured with the same disk environment and same size partitions as the system that performed the backup:

- ◆ If the new partition is *smaller* than the original partition, the recovery will not complete successfully.
- ◆ If the new partition is *larger* than the original partition the estimated size reported upon recovery is not accurate.

File matching with multiple ASMs in a directive

When a file matches multiple ASMs in a directive, the action taken on the file depends on the order of the ASMs in the directive. For example, if these ASMs are listed in a directive:

```
+always: master.mdf master.ldf
+skip *.mdf *.ldf
```

Then the master.mdf and the master.ldf files will be backed up because the always ASM is processed first. All other files with a .mdf or .ldf extension will not be backed up.

However, if the order of the ASMs is reversed:

```
+skip *.mdf *.ldf  
+always: master.mdf master.ldf
```

The master.mdf and the master.ldf files will not be backed up because the **skip** ASM is processed first.

Note: To simplify directives that include multiple potential matches for the same file, consider using save environment keywords. [“Save environment keywords” on page 177](#) provides more information.

This chapter covers these topics:

- ◆ Media pools..... 184
- ◆ Label templates..... 197

Media pools

Backup data is sorted onto backup media volumes by using media pools and volume labels. A media “pool” is a specific collection of volumes to which the NetWorker server writes data. The server uses media pools to sort and store data. A volume is identified with a unique label based on configurable label templates.

Media pools act as filters that tell the server which backup volumes should receive specific data. The NetWorker server uses media pools in conjunction with label templates (if the Match Bar Code Labels attribute is not used for the library resource) to keep track of what data is on which specific volume. [“Using label templates” on page 197](#) provides more information on label templates.

Note: Media pools do not apply when deduplication is used.

Using media pools

Each media pool configuration includes criteria that must be met in order for the data to be written to associated volumes.

When a scheduled backup occurs, the NetWorker server tries to match the save stream to a media pool configuration. If the save stream matches the criteria of a media pool configuration, it is directed to a labeled volume in the media pool. The server then checks if a correctly labeled volume for that media pool is mounted on a storage device:

- ◆ If a correctly labeled volume is mounted on a storage device, the NetWorker server writes data to the volume.
- ◆ If there is no correctly labeled volume mounted on a storage device, the NetWorker server requests that such a volume be mounted and waits until an operator or an autochanger mounts an appropriate volume.

Default media pool

If the save stream does not match the criteria for any custom (user-created) media pools, the NetWorker server directs the save stream to the Default media pool. Even if you use customized media pools, ensure that appropriate storage devices and media are available for the Default media pool for cases when the NetWorker server directs save streams there. If the media pools are not properly configured for backup, an error message similar to this may appear in the Monitoring Alerts tab in the Administration window:

```
media waiting (or critical): backup to pool 'Default' waiting for 1
writable backup tape or disk
```

NetWorker media pool types

NetWorker software contains preconfigured media pool types to keep different types of data separate. NetWorker software does not mix these types of data within a media pool:

- ◆ Backup
- ◆ Backup clone
- ◆ Archive
- ◆ Archive clone

- ◆ Migration
- ◆ Migration clone
- ◆ WORM (Write Once-Read Many)
- ◆ DLTWORM

Without any special sorting, all backup data is routed to the Default media pool and all archive data is routed to the Default Archive media pool. Likewise, clone data is routed to the appropriate Default Clone media pool. [“Creating a media pool” on page 191](#) provides information on customizing media pools.

Sorting data with media pools

When you configure the NetWorker server, you can create additional media pools and sort data by media pool type and any combination of the following:

- ◆ Group (backup group)
- ◆ NetWorker client
- ◆ Save sets (file or file systems)
- ◆ Backup levels (full, levels 1 – 9, incremental, manual)

When you select a group, the media pool accepts only data associated with the named group. If a second group name is added, the media pool accepts data associated with either group, but no others. If you enter configuration criteria in both the Group attribute and Save Set attribute, only data that meets both the group criteria *and* the save set criteria is written to volumes from the specified media pool. [Chapter 4, “Backup Groups and Schedules”](#) provides information about groups and backup levels.

Example 22 Using media pool configurations to sort data

[Figure 23 on page 186](#) illustrates how the NetWorker server uses media pool configurations to sort data. The save stream contains data from a full backup that was performed on client and save sets in a group called Accounting. The NetWorker server looks for a media pool configuration that matches the group named Accounting and the level full. When the NetWorker server finds the matching media pool configuration, it writes the data to a volume with a label from the corresponding Accounting Full media pool of volumes mounted on one of the storage devices.

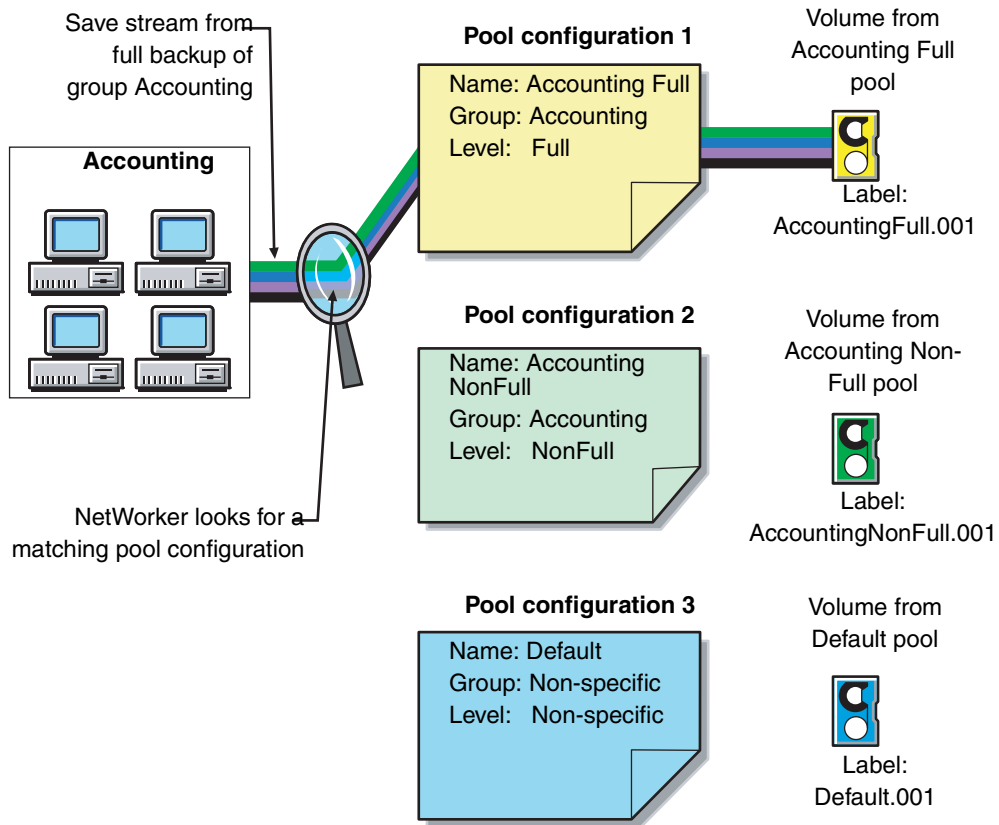

Figure 23 Using media pool configurations to sort data

Directing client file indexes and bootstrap to a separate media pool

You can use regular expression matching to direct the client file indexes and bootstrap to a media pool other than where you send the backup data.

Example 23 Sending bootstrap information and all the client file indexes to the same media pool

To send the NetWorker server's bootstrap and client file indexes to the same media pool, create a media pool (in the Media Pool resource) with the values listed for the attributes in [Table 27 on page 186](#).

Table 27 Attributes to direct client indexes and bootstrap to a separate media pool

Attribute	Value
Name	Index
Pool Type	Backup
Save Sets	Bootstrap index

When the group's scheduled backup runs, the client save sets are written to a volume labeled for the appropriate save set media pools, while the NetWorker server's bootstrap and index save sets are written to a separate volume labeled for the Index media pool.

Directing consolidated backup data to a specific media pool

By default, save sets from a consolidated backup are written to whatever media is mounted for the group most recently backed up.

To direct consolidated save sets to a specific set of media:

1. Configure a **Group** resource for consolidated backups. [“How to create a group” on page 134](#) provides information.
2. Configure a **Media Pool** resource for consolidated backups. [“Creating a media pool” on page 191](#) provides instructions.
3. In the **Create Media Pool** dialog box, select the name of the **Group** resource created in [step 1](#) for the **Groups** attribute.
4. Add each client that will receive consolidated backups to the group created for those backups.

Meeting the criteria for more than one media pool configuration

Depending on the media pool that is created, there may be data that matches the criteria for more than one media pool configuration. For example, if one media pool is configured to accept data from a group called Accounting and another media pool is configured to accept data from all full backups, it is not immediately clear which pool of volumes will be used for a full backup for the Accounting group. The NetWorker server uses this media pool selection criteria:

1. Group (highest precedence)
2. Client
3. Save set
4. Level (lowest precedence)

When data matches the attributes for two media pools, for example, Group and Level, the data is written to the media pool specified in the Group attribute. For example, in the case where the data from the group matched the criteria for two different media pools, the data is routed to the media pool that accepts data from the Accounting group.

Table 28 on page 188 details the hierarchy that the NetWorker server uses to determine media pool selection when a conflict arises. For example, the media pool criteria for Group takes precedence over the media pool criteria for client, save set, and level. Data that meets the criteria for both media pools is written to the media pool associated with the group. If data does not meet the criteria for any customized group, it is written to the Default media pool.

Table 28 NetWorker hierarchy for resolving media pool conflicts

Precedence	Group	Client	Save Set	Level
Highest	x	x	x	x
	x	x	x	
	x	x		x
	x	x		
	x		x	x
	x		x	
	x			x
	x			
			x	x
			x	
			x	x
				x
				x
	Lowest			

When no customized media pool criteria is met

When you sort data by using a customized media pool, you might inadvertently omit a client or save set. During a scheduled backup, if data does not meet the criteria for any customized media pool, the NetWorker server automatically sends the data to the Default media pool. By using the Default media pool, the server ensures that all data is backed up to a volume.

When the NetWorker server sends data to the Default media pool, it looks for a labeled volume from the Default media pool mounted on a storage device. If no Default media pool volume is mounted on a storage device, the server requests the appropriate volume and waits until an operator mounts the volume. If the NetWorker server asks for a Default media pool volume in the middle of a scheduled backup, the backup pauses until it has been mounted. If an operator is available to monitor backups, keep a Default media pool volume on hand should this situation arise.

To plan for unattended backups, run a test of the backup after making any configuration changes. This ensures that all data is written to the appropriate media pools of volumes, and avoids requests for a Default media pool volume.

Configuring media pools

This section provides information specific to the configuration of these media pool types:

- ◆ Incremental backups
- ◆ Manual backups
- ◆ Clone data
- ◆ Archive data

Note: You can create and edit media pools while a backup session is running. For each change, a message is written to the daemon log file, located in the <NetWorker_install_dir>\logs directory. [“Viewing log files” on page 663](#) provides information about viewing log files. You cannot delete a media pool that has labeled volumes in the media database.

Incremental backups

When creating a separate media pool for incremental backups, the NetWorker software’s hierarchy of precedence affects the way the data is stored. When a pool has been configured with a level incremental restriction and an incremental server initiated backup is performed:

- ◆ Incremental data will be routed to the media pool.
- ◆ The client file index will not go to the incremental pool. In an incremental backup, the associated index will backup at a level 9 to speed the recovery operation, if needed.

If the client indexes do not meet the criteria for the media pool associated with the incremental backups (that is, level 9 is not allowed), the indexes are matched to another media pool (usually the Default media pool) and an appropriately labeled volume is searched for. To recover the data, a large number of volumes may be required. To speed the recovery, define the level value of the appropriate pool to accept both level 9 and incremental data, rather than only incremental.

By using the preconfigured NonFull media pool, you ensure that the client file indexes belong to the same media pool as their incremental backups. By keeping the indexes in the same media pool as their incremental backups, you reduce the number of volumes required for a recovery.

Manual backups

You can create a customized media pool to receive data from a manual backup by specifying manual in the Level attribute. The NetWorker server, however, sorts data from a manual backup differently than it sorts data from a regularly scheduled backup. Since a manual backup is not performed as part of a scheduled backup group, by default the data is not associated with any group name. When you perform a manual backup in which only data from a single client or save set is saved, the group normally associated with that client or save set is not considered in any sorting. As a consequence, data from a manual backup may be sent to a media pool other than the one in which data from this client or save set is stored during a regularly scheduled backup. If you do not create a customized media pool to receive data from manual backups, the NetWorker server uses the Default media pool and looks for a mounted volume from the Default media pool on which to write data.

Note: Manual backups only back up file system data. Unlike scheduled backups, they do not back up the client file index at the end of the backup. The next server initiated backup of the client will backup the index. Manual backups can still be browsed at recovery time unless an index recover is performed before the index containing the save information has been backed up.

Clone data

To clone data, use a specific media pool to receive the clone data and a minimum of two devices:

- ◆ One to read the source volume
- ◆ One to write the clone

If data to be cloned is not associated with a customized Clone media pool, the Default Clone media pool is used. [Chapter 9, “Cloning”](#) provides more information.

Archive data

To archive data, use a specific media pool to receive the archived data. You can then store these volumes offsite. If data to be archived is not associated with a customized Archive media pool, the preconfigured Archive media pool is used. [Chapter 8, “Archiving”](#) provides more information about archive feature.

Using storage devices and media pool configuration to sort data

Data can be sorted by configuring media pools, in conjunction with storage devices, to either use specific media to receive data, or designate a specific storage device to receive data from a designated media pool.

Using different media

You can write data across several volumes of different media types (for example, magnetic disk and tapes) as long as the volumes mounted on the storage devices have the appropriate label associated with the media pool.

Using a specific device for backup data

You can associate a media pool with a specific storage device. For example, full backups may be written to optical disk for offsite storage. There are two ways to ensure that data goes to one specific storage device:

- ◆ Always keep a labeled volume associated with the appropriate media pool mounted on the specific storage device.
- ◆ Associate a specific media pool with the storage device in the Volume Pool attribute in the Device resource. Then, for the Media Pool resource, select that device for the Devices attribute. All data will be written only to that device.

Note: The only time you can assign a device to a media pool is when you label it. If you later want to assign the device to a different volume pool, you must relabel it.

Creating a media pool

Resource dialog box attributes vary depending on the server. Use the steps presented here as a general guideline. For additional information about each attribute, click **Field Help**.

Before creating a media pool, do either of the following:

- ◆ If the Match Bar Code Labels attribute is not used for the Library resource, create a label template for the media pool. [“Creating a label template” on page 200](#) provides more information.
- ◆ Determine a preconfigured label template to use for the media pool.

If you do not select a label template when creating a media pool, the NetWorker server notifies you that it will create a label template for the media pool.

To have the NetWorker server create the label template, click **OK**. [“Using label templates” on page 197](#) provides more information on label templates.

To create a media pool:

1. In the **Administration** window, click **Media**.
2. In the left pane, select **Media Pools**.
3. From the **File** menu, select **New**.
4. In the **Name** attribute, type a name for the media pool.

Note: A media pool is associated with a label template. Use a name that clearly associates the media pool with the corresponding label template.

5. In the **Comment** attribute, type a description of the media pool.
6. Select the **Enabled** attribute.
7. For the **Pool Type** attribute, select the appropriate media pool type.
8. In the **Label Template** attribute, select the matching label template.
9. In the **Data Source** attribute, select the backup groups that are eligible to back up to this media pool.
10. Select the **Selection Criteria** tab.
11. To further restrict which data can back up to this media pool, complete any of these attributes: **Client**, **Save Sets**, or **Level**. For guidelines about typing save set paths, see [“Expression matching of save sets to media pools” on page 192](#).
12. Select the **Configuration** tab.
13. In the **Auto Media Verify** attribute, select whether automated media verification will be performed while data is written to a volume associated with this media pool. For more information, see [“Auto media verification” on page 192](#).
14. Complete the other attributes as necessary, and click **OK**.

If any of the settings for a new media pool match an existing media pool, this message appears:

```
Pool(s) pool_name has overlapping selection criteria.
```

If this message appears, review the media pool configuration and modify any overlapping criteria.

Expression matching of save sets to media pools

If you enter a save set path, the Save Set attributes in the Media Pool resource are matched by using regular expression matching. This affects how the save set filenames are written, and how the path is written in this field for a Microsoft Windows system. Backslashes and periods must be preceded with a backslash:

- ◆ A save set path of C:\SomeDir\MyFiles should be written C:\\SomeDir\\MyFiles.
- ◆ A filename of MyFile.txt should be written MyFile\\.txt.

When using the **NetWorker Administrator** program, each save set in the Save Set attribute must be on a separate line. The following is an example of properly written save set entries:

```
/
/usr
C:\\Program Files\\bin
*\\.doc
```

The **nsr_regexp** and **nsr_pool** entries in the *EMC NetWorker Command Reference Guide* or the UNIX man pages provide information about regular expression matching.

Auto media verification

If the Auto Media Verify attribute is enabled, the NetWorker server verifies data written to volumes from this media pool.

Data is verified by repositioning the volume to read a portion of the data previously written to the media. The data read is compared to the original data written. This feature does not verify the entire length of the tape.

If the data read matches the data written, verification succeeds.

Media is verified when the following occurs:

- ◆ A volume becomes full while saving and it becomes necessary to continue on to another volume.
- ◆ A volume goes idle because all save sets being written to the volume are complete.

When a volume fails verification, it is marked full so that the server will not select that volume for future saves. The volume remains full until it is recycled or a user marks it not full. If a volume fails verification while the server is attempting to switch volumes, all save sets writing to the volume are terminated.

Auto media verification should not be used to verify the integrity of the data written to the entire tape. To fully verify the data written to the tape, either restore the tape contents or clone the data.

Supporting WORM and DLTWORM tape drives

NetWorker supports write-once, read-many (WORM) tape drives and media. It is able to recognize the WORM abilities of tape drives and the presence of WORM media in those drives. It also supports the creation of DLTWORM (formerly DLTIce) tapes in drives that are DLTWORM capable.

Table 29 on page 193 describes the WORM devices that are supported by the NetWorker software.

Table 29 WORM supported devices

Device	Description
HP LTO Ultrium 3	Unique to HP Ultrium-3 <ul style="list-style-type: none"> Inquiry VPD page 0xb0, byte 4 bit 0 indicates WORM capable Read attribute # 0x0408 bit 7 to indicate WORM media present
Quantum SDLT600, DLT-S4, and DLT-V4 (SCSI and SATA)	Any drive with product inquiry data of “*DLT*” tape drive that reports WORM capability the way these drives do. (“Quantum” not required in the vendor inquiry data.) <ul style="list-style-type: none"> Inquiry data VPD page 0xc0, byte 2, bit 0 to indicate WORM capable Read attribute # 0x0408 bit 7 to indicate WORM media present
Sony AIT-2, AIT-3, AIT-4, and SAIT	Any drive with “Sony” in the vendor inquiry data that reports WORM capability like these drives do: <ul style="list-style-type: none"> Mode sense page 0x31, byte 5 bit 0 indicates WORM capable Mode sense byte 4 bit 6 indicates WORM tape present
IBM 3592	Unique to IBM 03592 <ul style="list-style-type: none"> Mode sense page 0x24, byte 7 bit 4 indicates WORM capable Mode sense page 0x23, byte 20 bit 4 indicates WORM tape present
STK 9840A/B/C, 9940B, T10000	Any drive with STK as the vendor data that reports WORM capability like these: <ul style="list-style-type: none"> Standard inquiry data byte 55 bit 2 indicates WORM capable Request sense data byte 24 bit 1 indicates WORM tape present
IBM LTO Ultrium 3, and Quantum LTO Ultrium 3	These drives use the SCSI-3 method to report WORM capabilities, so there is not a match against any of the inquiry data. Any drive that does not match the inquiry data patterns listed above will have the SCSI-3 method applied to them. <ul style="list-style-type: none"> Inquiry data VPD page 0xb0, byte 4, bit 0 indicates WORM capable Mode sense page 0x1d, byte 2 bit 0 indicates WORM tape present Byte 4, bits 0,1: label restrictions include <ul style="list-style-type: none"> - 00 indicates no overwriting allowed - 01 indicates some labels can be overwritten Byte 5, bits 0,1: filemark overwrite restrictions <ul style="list-style-type: none"> - 0x02: any filemark at EOD can be overwritten except for the one closest to the beginning of the tape - 0x03: any filemark at EOD can be overwritten

The WORM and DLTWORM attributes determine whether or not the NetWorker software will back up to a write once-read many (WORM) tape. You can apply these tape attributes to any pool.

Note: Various Quantum drive models (SDLT600, DLT-S4, and DLT-V4) have the ability to create WORM tapes from ordinary blank DLT tapes supported by that particular drive. You cannot recycle an existing NetWorker tape to create a DLTWORM volume without first having bulk-erased the tape. When the DLTWORM attribute is set, labeling one of these drives into a WORM pool causes the Quantum drive to make the current tape a WORM tape.

Savegroups that belong to pools that have either the WORM or DLTWORM attribute set, are considered to be WORM savegroups.

Identifying WORM media

Since WORM media cannot be reused, the tapes are uniquely identified as such so that they are only used when required. As shown in [Figure 24 on page 194](#), a (W) is appended to the volume names displayed in the NetWorker Administrator window. If a volume is both read-only and WORM, an (R) is appended to the volume name.

Volume Name	Barcode	Used	% Used	Mode	Expiration	Location	Pool
000000	000000	0 KB	0%	appen			Default
000016	000016	0 KB	0%	appen			Default
000017	000017	0 KB	0%	appen			Default
000018	000018	0 KB	0%	appen			Default
000024	000024	0 KB	0%	appen			Default
000134(W)	000134	0 KB	0%	appen	manual	rd=aurora.A...	WORM
ait2_worm.001(W)		0 KB	0%	appen	manual		worm
ameba.003		0 KB	0%	appen			Default
arch_talks_backup_12_05_2005		194 GB	97%	appen	manual		Default
berferd.001		152 GB	95%	appen	manual		worm
bobs_first_tape(R)		34 GB	17%	recyc	expired		Default
dltv4_worm_001		0 KB	0%	appen		9	Default
dltworm.001		0 KB	0%	appen	manual		worm
fatdat.ameba.001(R)		1356 MB	2%	recyc	expired	9	Default
NEGHV.AR.DDS.001(R)		269 MB	0.1%	recyc	expired		Default
not_the_worm.001		15 GB	15%	appen			Default
not_worm_new.001		0 KB	0%	appen		9	Default
sait_via_polarbear.001		1091 MB	full		9/12/06		Default

Figure 24 Identifying WORM tapes in the NetWorker Console

Note: Since WORM tapes can only be used once, attempting to relabel a WORM tape always results in a write protection error. With the exception of pool selection and relabeling, the NetWorker software treats WORM tapes exactly the same as all other types of tape.

Configuring WORM and DLTWORM support

To determine if a device is WORM or DLTWORM capable:

1. In the **Administration** window, click **Devices**.
2. Select the drive, right-click, and select **Properties**.
3. Click the **Information** tab and observe the WORM capable and DLTWORM capable attribute settings. NetWorker automatically sets these attributes and, consequently, they are read-only and cannot be changed.

Note: The WORM capable and DLTWORM capable attributes are dimmed out when the device in use is WORM capable but does not support DLTWORM (not a Quantum DTL-type drive).

To configure pools to accept WORM or DLTWORM devices:

1. In the **Administration** window, click **Media**.
2. In the left pane, select **Media Pools**.
3. In the right pane, select the appropriate pool.
4. Right-click and select **Properties**.

5. Click the **Configuration** tab and select one of these WORM tape handling attributes:
 - WORM pools only hold WORM tapes
 - WORM tapes only in WORM pools
6. Click **OK** when finished making the necessary selections.

Note: If you attempt to assign a non-WORM capable drive to a WORM pool an error message is generated.

Table 30 WORM/DLTWORM attributes

Attribute	Description
WORM pools only hold WORM tape	By default, the NetWorker software only allows WORM tapes into WORM pools. Deselecting this option lets you add new (non-WORM) tapes to a WORM pool. This is useful when you need WORM functionality but do not have WORM tapes available.
WORM tapes only in WORM pools	By default, NetWorker only lets you label WORM tapes into WORM pools. Clear this option when: <ol style="list-style-type: none"> 1. You do not want to segregate WORM tapes within WORM pools. 2. A volume is needed to complete a group and a non-WORM tape is unavailable.
WORM capable	This attribute indicates that this drive supports the use of WORM media.
DLTWORM capable	This attribute indicates that this drive can create DLTWORM tapes from a blank tape.
WORM pool	This pool should hold WORM tapes (depending on the setting of "WORM pools only hold WORM tape" in the server).
create DLTWORM	<p>If selected, before the NetWorker software labels a tape in a drive capable of creating DLTWORM volumes, NetWorker will try to convert the tape into a DLTWORM tape. If that conversion fails, the labeling for that tape will fail. If a tape drive in a pool where this attribute is set cannot create DLTWORM tapes, (that is, the tape drive is not a Quantum SDLT600, DLT-S4 or DLT-V4 tape drive, this attribute is simply ignored.</p> <hr/> <p>Note: Refer to the Quantum web site for information on which tapes can be converted to DLTWORM tapes.</p> <p>Not all firmware revisions for all of these devices support WORM operation. Check the tape drives website to make sure that your drive has up-to-date firmware.</p> <hr/>

Working with media pools

This section explains how to edit, copy, delete, and create media pools.

Editing a media pool

Note: You cannot change the name of a media pool. Preconfigured media pools cannot be modified.

To edit a media pool:

1. In the **Administration** window, click **Media**.
2. In the left pane, select **Media Pools**.
3. In the right pane, select the media pool.
4. From the **File** menu, select **Properties**.
5. In the **Properties** dialog box, make the necessary changes and click **OK**.

Copying a media pool

To copy a media pool:

1. In the **Administration** window, click **Media**.
2. In the left pane, select **Media Pools**.
3. In the right pane, select the media pool.
4. From the **Edit** menu, select **Copy**. The **Create Media Pool** dialog box appears, containing the same information as the media pool that was copied, except for the Name attribute.
5. In the **Name** attribute, type a name for the new media pool.
6. Edit any other attributes as appropriate, and click **OK**.

For details about the **Media Pool** attributes, click **Field Help** in the **Properties** dialog box.

Deleting a media pool

Note: You can delete a media pool only if there are no active volumes assigned to the media pool. Preconfigured media pools cannot be deleted.

To delete a media pool:

1. In the **Administration** window, click **Media**.
2. In the left pane, select **Media Pools**.
3. In the right pane, select the media pool.
4. From the **File** menu, select **Delete**.
5. When prompted, click **Yes** to confirm deletion.

Creating an archive media pool

To archive data, the NetWorker server requires an archive media pool to receive the archive data. If data to be archived is not associated with a custom archive media pool, the server automatically uses a preconfigured archive media pool. An appropriately labeled volume must be mounted on a storage device for the archive process to proceed.

To create an archive media pool:

1. Create a new media pool. [“Creating a media pool” on page 191](#) provides instructions.
2. From the **Pool Type** attribute, select **Archive** from the list.
3. Select the **Configuration** tab.
4. Clear the **Store index entries** attribute.

Label templates

The NetWorker server creates a unique label for each volume by applying a label template. This section describes how label templates and media pools are used to sort, store, and track data on media volumes.

Using label templates

The NetWorker server selects the media pool to which a given set of data is written. A volume is associated with a media pool by its volume label.

The contents of the volume label follow rules that are defined in a specific label template. You then associate a label template with a specific media pool in the Media Pool resource. If you do not associate data with a specific media pool, the NetWorker server uses the preconfigured Default media pool and corresponding Default label template.

Figure 25 illustrates how a media pool configuration uses its associated label template to label a volume. For the label template name to appear as a choice in the Media Pool resource, you must configure a label template before configuring the associated media pool.

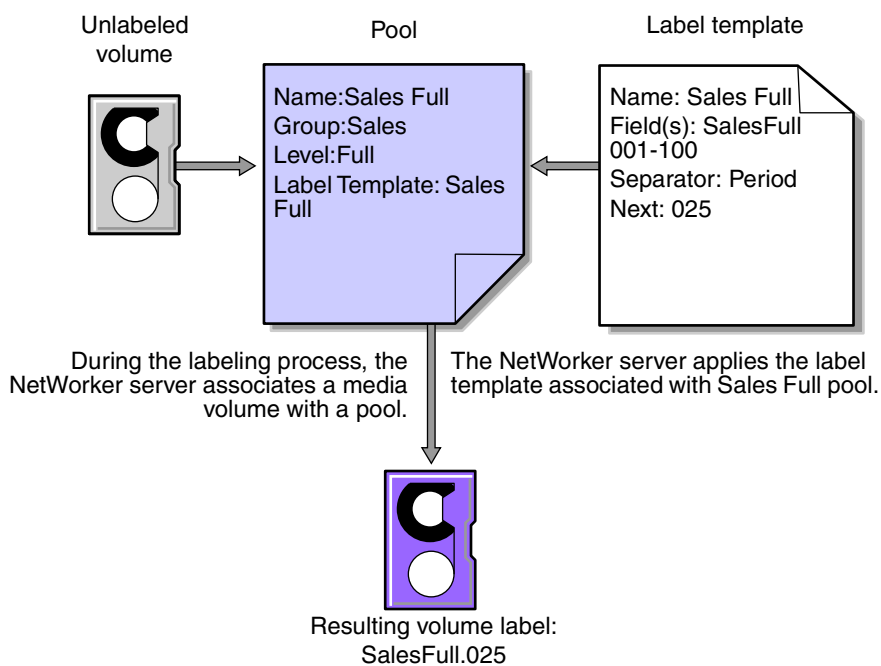

Figure 25 Labeling a volume by using a label template

Using preconfigured label templates

The NetWorker server contains these preconfigured label templates, which correspond to the preconfigured media pools:

- ◆ Default
- ◆ Default clone

- ◆ Archive
- ◆ Archive clone
- ◆ Full
- ◆ Indexed archive
- ◆ Indexed archive clone
- ◆ NonFull
- ◆ Offsite
- ◆ PC archive
- ◆ PC archive clone
- ◆ Two Sided

Label templates have multiple fields separated by periods. The first field represents the name of the NetWorker server and the final field contains a number to allow for expansion of the media pool. The number range from 001 to 999. For example:

```
mars.001
jupiter.054
jupiter.archive.197
```

Completing Label Template attributes

There are certain guidelines to keep in mind when completing the attributes for a Label Template resource. [Table 31](#) describes how to complete the key attributes for this resource. [“Creating a label template” on page 200](#) provides more information on creating a label template.

Table 31 Key label template attributes (1 of 2)

Attribute	Guidelines
Name	<p>Keep the label name consistent with the media pool name, so that the label name reflects how the data is organized. For example, a label template named "AcctFull" would identify volumes that belong to a media pool called "Accounting Full."</p> <p>Do not use these characters in label template names: /*?[]() \$!^;' "' ~ <> & { } : - . _</p>
Fields	<p>A label template is made up of one or more fields. Each field, or component, provides a layer of specificity to your organizational structure. There can be any number of components, but it is best to keep the template simple with as few as necessary. The label cannot exceed 64 characters.</p> <p>You can use four types of components:</p> <ul style="list-style-type: none"> • Range of numbers (for example, 001-999) • Range of lowercase letters (for example, aa-zz) • Range of uppercase letters (for example, AA-ZZ) • Character string (for example, Accounting) <p>Each range includes a start value, a dash (-), and an end value. The start value and the end value must have the same number of characters. For example, use 01-99 (not 1-99) or aaa-zzz (not aa-zzz).</p> <p>The order in which you enter each component of the Field attribute is important. The NetWorker server applies each component in a left-to-right order, starting with the first one entered. Table 32 on page 199 illustrates how label templates use components to create a number sequence for volume labels.</p>

Table 31 Key label template attributes (2 of 2)

Attribute	Guidelines
Separator	Choose the symbol to appear between component entries. Use the period, dash, colon, or underscore to separate each component of the label template. If label components do not have separators (for example, AA00aa), the labels can be difficult to read.
Next	<p>Choose the next sequence number to write on the label that the NetWorker server places on a volume (according to the template).</p> <ul style="list-style-type: none"> To force a label to start the label scheme at a particular point, type a start label value. The server continues to generate labels from that point on, according to the rules of the template. To have the NetWorker server generate the first label, leave this attribute blank. <p>When the NetWorker server recycles a storage volume, the volume label does not change as long as the volume remains in the same media pool. That is, if a storage volume labeled "Dev.006" is recycled, it retains the volume label "Dev.006" and does not receive a new label with the next sequence number.</p>

Table 32 lists examples of number sequences for volume labels.

Table 32 Examples of number sequences for volume labels

Type of components	Fields	Number sequence result	Total number of labels
Range of numbers	001-100	001, 002, 003,...100	100
Character string Range of numbers	SalesFull 001-100	SalesFull.001,...SalesFull.100	100
Range of lowercase letters Range of numbers	aa-zz 00-99	aa.00,...aa.99, ab.00,...ab.99, ac.00,...ac.99, : az.00...az.99, ba.00,...ba.99 : zz.00,...zz.99	67,600 (26 ² times 10 ²)

The label template should allow for expansion of the backup media storage system. For example, it is better to create a template for 100 tapes and not use all of them, than it is to create a template for only 10 tapes and run out of labels. When the server reaches the end of the template numbering sequence, it wraps to the starting value. For example, after zz.99 (used for the 67,600th label), the next label the server uses is aa.00 for label 67,601.

Note: When the NetWorker server recycles a volume, the volume label does not change if the volume remains in the same media pool. That is, if a volume labeled Dev.006 is recycled, it will retain the volume label Dev.006 and will not receive a new label with the next sequence number. The original data on the volume, however, will be overwritten by the new data.

Naming label templates

The NetWorker server is packaged with preconfigured label templates that correspond to the preconfigured media pools. If you choose to create the templates, you can include any number of components in the Fields attribute. However, it is best to keep the template simple with as few components as necessary for your organization.

For example, if you create a label template for an accounting department, you can customize the label template in several ways, depending on the size of the storage system and media device capabilities.

Table 33 illustrates several ways you can use components to organize labels.

Table 33 Using label template components

Type of organizational structure	Components	Separator	Resulting volume labels
Sequential	AcctFull '001-100	period	AcctFull.001 (100 total labels)
Storage oriented (for example, 3 storage racks with 5 shelves each, each shelf holding 100 tapes)	1-3 1-5 001-100	dash	1-1-001 This label is for the first tape in rack 1 on shelf 1. (1,500 total labels)
Two-sided media (for example, optical devices)	AcctFull 000-999 a-b	underscore	AcctFull_000_a (side 1) AcctFull_000_b (side 2) (2,000 total labels)

Labeling tips

Naming schemes vary from site to site. One way is to name the volumes with the name of the NetWorker server followed by a three-digit number, for example:

```
jupiter.001
```

Consider that the simpler a convention is, the easier it can be understood by operators and administrators.

Note: The maximum length for a volume name is 63 characters. With advanced file type devices (`adv_file`), the maximum length is 60 characters.

Each volume should have a physical (adhesive) label attached to it. Since the NetWorker server keeps track of the backups and which volumes they are on, you can name the volumes with any convenient name. For example, you can label your volumes 1, 2, 3, or Monday.1, Tuesday.1, Wednesday.1. You can assign a volume any name as long as each one is unique.

The adhesive label on the volume should match the name generated by NetWorker. For example, if you physically label a volume mars.1, its NetWorker name should also be mars.1.

Working with label templates

This section explains how to create, edit, copy, and delete label templates.

Creating a label template

When creating a label template, consider the labeling guidelines described in [Table 31 on page 198](#).

To create a label template:

1. In the **Administration** window, click **Media**.
2. In the expanded left pane, select **Label Templates**.
3. From the **File** menu, select **New**.
4. Enter the components for the label template:

- **Name:** The name of the new label template.
 - **Comment:** Any user-defined description or explanatory remarks about the label.
 - **Fields:** A list of label components.
 - **Separator:** The character to be inserted between label components. If no symbol is selected, the components will have no separators, such as hostarchive[001-999].
 - **Next:** (Optional) Enter the next label to be generated by the template.
5. Click **OK**.

Editing a label template

You cannot change the name of a label template. However, to change an individual label name, delete the existing name in the **Next** text box, and type a new name.

To edit a label template:

1. In the **Administration** window, click **Media**.
2. In the expanded left pane, select **Label Templates**.
3. In the right pane, select the template to edit.
4. From the **File** menu, select **Properties**.
5. In the **Properties** dialog box, make any necessary changes and click **OK**.

Copying a label template

To copy a label template:

1. In the **Administration** window, click **Media**.
2. In the expanded left pane, select **Label Templates**.
3. In the right pane, select the label template to copy.
4. From the **Edit** menu, select **Copy**. The **Create Label Template** dialog box appears, containing the same information as the label template that was copied, except **Name** attribute.
5. In the **Name** attribute, type the name for the new label template.
6. Edit any other attributes as appropriate, and click **OK**.

Deleting a label template

You cannot delete a preconfigured label template or a label template that is in use.

To delete a label template:

1. In the **Administration** window, click **Media**.
2. In the expanded left pane, select **Label Templates**.
3. In the right pane, select the label template to delete.
4. From the **File** menu, select **Delete**.
5. When prompted, click **Yes** to confirm the deletion.

This chapter covers these topics:

◆ Overview of archiving.....	204
◆ Permissions for archiving	206
◆ About archive pools.....	207
◆ Creating custom Archive pools.....	207
◆ Archiving data procedures	208
◆ Retrieving archived data	212
◆ Archive request management.....	215

Overview of archiving

The archive process captures files or directories as they exist at a specific time, and writes the data to archive storage volumes, which are *not* automatically recycled. After the archive process completes, you can delete (“groom”) the original files from the disk to conserve space.

Archive save sets are similar to backup save sets. The main difference is that archive save sets have no expiration date. By default, the archive backup level is always set to full. Archive data must be written to separate pools. Browse and retention policies do *not* apply to archive data.

Note: The archive feature must be purchased and licensed separately from other NetWorker software components. The new for 7.6 Service Pack 1, *NetWorker Licensing Guide* provides more information on licensing procedures.

Benefits of using the NetWorker archive feature include:

- ◆ Files that have been archived can be:
 - Deleted from the primary disk storage to make space for newer files.
 - Retained in archive volumes for quick retrieval.
- ◆ Archived data is never subject to automatic recycling, so it *cannot* be overwritten accidentally.
- ◆ Files on archived volumes that use the Indexed Archive pool and the PC Archive pool can be browsed indefinitely.

Note: NetWorker software does not support archiving of SYSTEM or VSS SYSTEM save sets.

Archive requirements

Before NetWorker archive feature, ensure that you have:

- ◆ A device, either stand-alone or in an autochanger or silo, connected to a NetWorker server or storage node. If you are cloning archives, you must have at least two devices available.
- ◆ A temporary or permanent enabler code to license the product after any evaluation period is over. The new for 7.6 Service Pack 1, *NetWorker Licensing Guide* provides more information.

How the NetWorker server archives data

The NetWorker software provides three preconfigured pools to receive archived data:

- ◆ Indexed Archive pool
- ◆ PC Archive pool
- ◆ Archive pool

You can also create custom archive pools. During the archive operation, the NetWorker server writes data to storage volumes that belong to an Archive pool. Information about archive data is tracked in the NetWorker server’s media database.

If you use the preconfigured Indexed Archive pool or PC Archive pool, or if you create a custom Archive pool that has the Store Index Entries attribute in the Pool resource set to Yes, information about individual files in the archive save set are tracked in the client file index. The client file index entries that are generated during an archive are backed up to volumes from the Default pool during the next scheduled backup.

Note: Index entries are not generated when the Store Index Entries attribute in the Pool resource is set to No.

The NetWorker server tracks the volumes used for archives separately from those used for backups. You *cannot* archive files to a backup volume, nor can you back up files to an archive volume. An archive volume must be loaded and mounted in the server device to complete an archive.

Whether you initiate the archive on the client or the server, the archive is created by the client's archive program (**nsrchive**), which is initiated by the client's **nsrexecd** service. You can schedule archives from the server or client by using the Archive Requests resource in the NetWorker Administrator program.

Figure 26 on page 205 illustrates how the NetWorker software archives data.

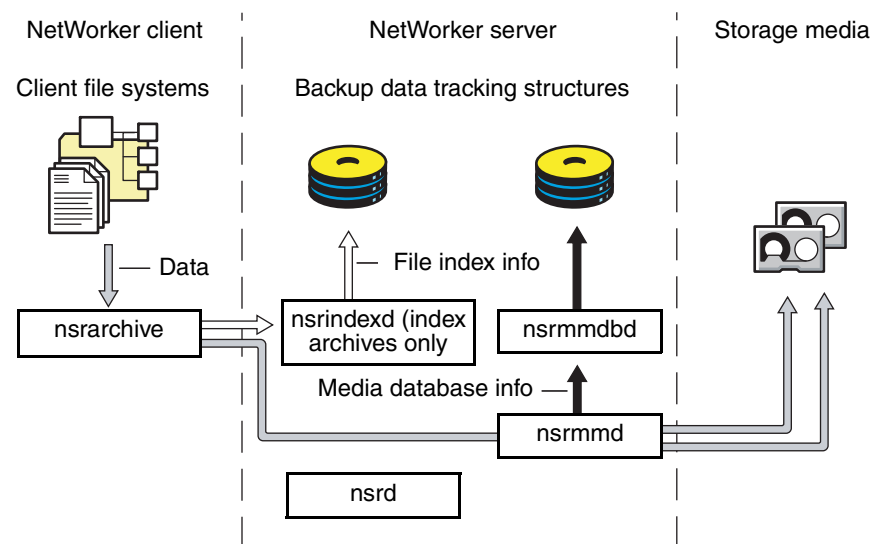

Figure 26 Overview of archive operation

Indexed and nonindexed archiving

The NetWorker server supports two styles of archiving:

- ◆ Indexed archiving for Indexed Archive pools or PC Archive pools
- ◆ Nonindexed archiving for Archive pools

Indexed archiving (Indexed Archive pool, PC Archive pool)

One can browse and select indexed archives for individual file recovery.

To use indexed archiving, do one of the following:

- ◆ Use the preconfigured Indexed Archive pool or the PC Archive pool.
- ◆ Enable the Store Index Entries attribute of the Pool resource associated with the archive volume.

The client file index entries that are generated during an archive are backed up to volumes from the Default pool during the next scheduled backup.

Nonindexed archiving (Archive pool)

When data is archived by using nonindexed archiving, entries are not added to the client file index. When this data is retrieved, the entire save set is retrieved and you cannot browse or recover individual files.

Permissions for archiving

This section describes the permissions required to use the archive feature.

Enabling archive services for the client

After the archive service is licensed and the enabler code has been entered into the NetWorker server, all clients of that server are enabled for the NetWorker archive feature by default. To disable the archive feature for a specific client, set the Archive Services attribute in the Client resource to Disabled.

To archive data that resides on the NetWorker server, ensure that the Archive Services attribute is enabled in the Client resource for the server. [“Enabling archive services for a NetWorker client” on page 208](#) provides instructions.

When you enable the Archive Services attribute for a Client resource, enable the Archive Services attribute for all other clients of the same name on that server. For example, if the NetWorker Module for a database application and the NetWorker client software are installed on the same computer and both back up to the same NetWorker server, both Client resources have the same name. Ensure that the Archive Services attribute is enabled for both Client resources.

Enabling or restricting archive access

The Archive Users attribute in the Client resource specifies the users who are allowed to archive data. If no users are listed in this attribute, only members of the NetWorker Administrators group with read permissions to the data can archive the data. To enable users who are *not* members of the Administrators group to archive data, include their usernames in this attribute. These users must have read permissions to the data and Backup Local Data privileges to archive or retrieve the data. [“NetWorker User Groups” on page 442](#) provides more information about the Administrators group and the Backup Local Data privilege.

Note: Only members of the Administrators group or users with the Change Security Settings permission enabled can change the Archive Users attribute.

Users can only retrieve data that they own. If other users need to retrieve data they do *not* own, public archives access must be enabled.

Enabling public archive access

To allow users listed in the Archive Users attribute of the Client resource to retrieve any archived files from that client:

1. In the **Administration** window, click **Configuration**.
2. In the left pane of the **Configuration** window, select the NetWorker server.
3. From the **File** menu, select **Properties**.
4. Select the **Public Archives** attribute and then click **OK**.

If, during recovery, the operating system allows you to change the ownership of archived data to that of the original owners, then the retrieved files display the original ownerships. Otherwise, the user who retrieves the files becomes the owner of the files.

About archive pools

The NetWorker software provides these three preconfigured pools to receive archived data:

- ◆ Preconfigured Indexed Archive pool
- ◆ PC Archive pool
- ◆ Preconfigured Archive pool

You cannot change the settings for these preconfigured pools, although you can create custom pools for archiving data. Custom pools can use either indexed or nonindexed archiving. [“Creating custom Archive pools” on page 207](#) provides information on creating custom Archive pools.

If you do not specify a pool to store archived data, the NetWorker software uses the Indexed Archive pool by default.

Preconfigured Indexed Archive pool and PC Archive pool

The preconfigured Indexed Archive pool and the PC Archive pool store entries for individual files in the client file index.

Note: Use of the Indexed Archive pool or the PC Archive pool may create a large client file index that never expires.

Preconfigured archive pool

The preconfigured Archive pool does not have a browsable client file index associated with it. You cannot retrieve individual files from the archive save set. Instead, you must retrieve the entire save set.

Creating custom Archive pools

Two attributes in the Pool resource distinguish Archive pools from other pools:

- ◆ Pool Type - This attribute must be set to Archive, which tells the NetWorker server that volumes belonging to this pool are used for archiving.

- ◆ Store Index Entries - This attribute determines whether the archive is an indexed or nonindexed archive:
 - If this attribute is set to No, entries are *not* written to the client file index (nonindexed archiving).
 - If this attribute is set to Yes, entries are written to the client file index (indexed archiving).

[“Media pools” on page 184](#) provides details and procedures about creating pools.

Archiving data procedures

You can request manual archives from the client, or you can schedule archives from the server.

Enabling archive services for a NetWorker client

To enable archive services for a NetWorker client:

1. In the **Administration** window, click **Configuration**.
2. In the left pane of the **Configuration** window, select **Clients**:
 - a. If you are creating a new client, select **New** from the **File** menu.
 - b. If you are editing an existing client, select the client and then select **Properties** from the **File** menu.
3. On the **Globals (2 of 2)** tab, enable the **Archive Services** attribute. When you enable archive services for one Client resource, archive services are enabled for all Client resources with the same hostname.
4. In the **Archive Users** attribute, type all appropriate users. [“Enabling or restricting archive access” on page 206](#) provides details about setting this attribute.
5. Make the remaining configuration choices as appropriate. The computer is now an enabled archive client. However, an archive will not occur until it is requested. [“Scheduling data archives” on page 209](#) provides instructions.

Note: If the NetWorker client is set up for encryption with the aes ASM, archive data will also be encrypted. [“Encrypting backup data” on page 77](#) provides information about setting up encryption for a NetWorker client.

Manually archiving data

You can manually archive data at any time. Manually archiving data is similar to performing a manual backup.

Perform a manual archive from a NetWorker client on Windows

Note: Manual archives that are performed from a Windows client do not enforce global or local file (nsr.dir) directives. However, local directives (networkr.cfg) that are created with the NetWorker User program are enforced. Scheduled archives, enforce all directives. For more information about scheduled archives, see [“Scheduling data archives” on page 209](#).

To perform a manual archive for a Windows client:

1. In the NetWorker **User** program, click **Archive** to open the **Archive Options** dialog box.
2. Type a comment in the **Annotation** attribute. This annotation is used to uniquely identify each archive save set during retrieval.

Note: Consider adopting a consistent naming convention so that one can easily identify archives based on the annotation name.

3. From the **Archive Pool** list, select the appropriate archive pool.

Note: Only pools with their Pool Type attribute set to Archive are listed.

4. Select the appropriate settings for these criteria:
 - To write a copy of each archive save set to a volume from an archive clone pool, select **Clone**.
 - If you enable cloning, type or select an archive clone pool for the **Archive Clone Pool** attribute.
 - To instruct the NetWorker server to check the integrity of the data on the storage volume, select **Verify**.
 - To instruct the NetWorker server to remove the archived files from the disk, select **Grooming**.
5. Click **OK**. The **Archive browse** window appears.
6. From the **File** menu, select **Mark** to select each file or directory for archiving. When you select an item for archiving, a check mark appears next to that item.

Note: To clear an item currently marked for backup, select **Unmark** from the **File** menu.

7. From the **File** menu, select **Start Archive**.
8. Click **OK** and the **Archive** browse window appears. The NetWorker server appears in the **Archive Status** window, which monitors the progress of the archive. When the NetWorker server is finished archiving, a message similar to this appears in the **Archive Status** window:

Archive completion time: 2-21-09 5:18p

9. If **Groom** was selected in [step 4](#), the **Remove Archived File** dialog box prompts for confirmation before NetWorker software deletes archived files from the local disk.

Perform a manual archive from a NetWorker client on UNIX

To perform a manual archive from a UNIX client, use the **nsrchive** command. For information about this command, refer to the *EMC NetWorker Command Reference Guide* or the UNIX man pages.

Scheduling data archives

Unlike scheduled backups, scheduled archives run only once. The advantage of a scheduled archive is that the archive can be run when network traffic and computer use is low.

Scheduling an archive

Before you can schedule an archive request, enable the Archive Services attribute in the Client resource. [“Enabling archive services for a NetWorker client” on page 208](#) provides more information.

To schedule an archive:

1. In the **Administration** window, click **Configuration**.
2. In the left pane, select **Archive Requests**.
3. From the **File** menu, select **New**.
4. In the **Name** attribute, type a name for the archive request.
5. In the **Comment** attribute, type a description of the archive request.
6. In the **Client** attribute, type the archive client’s hostname.
7. In the **Save Set** attribute, type the pathnames of the files and/or directories to be archived.

Note: If you archive all of the client’s save sets, set the **Grooming** attribute (on the **Running** tab) to **None**. If this attribute is set to **Remove**, all of the archived save sets will be deleted from the client computer.

8. Type a comment in the **Annotation** attribute. This annotation is used to uniquely identify each archive save set during retrieval.

Note: Consider adopting a consistent naming convention so that one can easily identify archives based on the annotation name.

9. In the **Directive** attribute, select a directive if special processing is to occur during the archive process. [Chapter 6, “Directives”](#) provides more information about directives.
10. From the **Archive Pool** attribute, select the appropriate pool from the list:
 - To store the entire save set, select the preconfigured **Archive** pool. This pool does *not* store the client file index.
 - To store the client file index in addition to the entire save set, select the preconfigured **PC Archive** pool.
11. Select the **Running** tab.
12. For the **Status** attribute, indicate a start time for the archive:
 - To begin the archive immediately, select **Start Now**.
 - To begin the archive at a specified time, select **Start Later** and indicate a time in 24-hour format in the **Start Time** attribute.
13. For the **Archive Completion** attribute, type a notification for the NetWorker server to use after completing the archive. [“Notifications” on page 447](#) provides details.
14. Select the appropriate response for these options:
 - To instruct the NetWorker server to remove the archive files from the disk, select **Remove** from the **Grooming** list.
 - To instruct the NetWorker server to check the integrity of the data on the storage volume, select the **Verify** attribute.

- To write a copy of each archive save set to a volume in an **Archive Clone pool**, select **Yes** for the **Clone** attribute and select an archive clone pool from the **Archive Clone Pool** list.

15. Click **OK**.

To view information about the status of an archive request, open the **Archive Request Details** window. [“Viewing details of a scheduled archive” on page 215](#) provides more information.

Copying an Archive Request resource

To copy an Archive Request resource:

1. In the **Administration** window, click **Configuration**.
2. In the left pane, select **Archive Requests**.
3. In the right pane, select the archive request to copy.
4. From the **Edit** menu, select **Copy**. The **Create Archive Request** dialog box displays the same information as the archive request that was copied, except for the Name attribute.
5. Type the name for the new archive request in the **Name** attribute, edit any other attributes as appropriate, and click **OK**.

For details about the **Archive Request** attributes, click **Field Help** in the **Properties** dialog box.

Changing the archive time

To change the archive time:

1. In the **Administration** window, click **Configuration**.
2. In the left pane, select **Archive Requests**.
3. In the right pane, select an archive request.
4. From the **File** menu, select **Properties**.
5. Click the **Running** tab.
6. In the **Start Time** attribute, type a new time in this format:
HH:MM [a, p]
7. Click **OK**.

You can also schedule an existing archive by using the **Schedule Archive** operation in the **Activities Monitor**. [“Archive request management” on page 215](#) provides more information.

Editing an archive request

To edit an archive request:

1. In the **Administration** window, click **Configuration**.
2. In the left pane, select **Archive Requests**.
3. In the right pane, select an archive request.
4. From the **File** menu, select **Properties**.
5. Edit the attributes of the archive request and click **OK**.

Deleting an archive request

Note: You cannot delete an archive request that is currently in use.

To delete an archive request:

1. In the **Administration** window, click **Configuration**.
2. In the left pane, select **Archive Requests**.
3. In the right pane, select an archive request.
4. From the **File** menu, select **Delete**.

Retrieving archived data

This section describes how to retrieve archived data.

Retrieval permissions

The following restrictions apply when retrieving or recovering archived data:

- ◆ You must have read permissions to the archived data.
- ◆ If the Server resource's Public Archives attribute is enabled, all users listed in the Client resource's Archive Users attribute can retrieve data (as long as they have read permissions to the data).
- ◆ If the Server resource's Public Archives attribute is disabled, only the NetWorker administrator or the owner of the file can retrieve the data.

["Permissions for archiving" on page 206](#) provides more information.

Note: If, during retrieval, the operating system allows you to change the ownership of archived data to that of the original owners, then the retrieved files display the original ownership. Otherwise, the user who retrieves the files becomes the owner of the files.

Retrieving nonindexed archives from a client on Windows

Data that was archived with a nonindexed archive pool (such as the Archive pool) must be retrieved by the entire save set rather than by file selection.

To retrieve nonindexed archived data:

1. Mount the archive volume in the appropriate storage device.
2. Start the NetWorker **User** program.
3. From the **Operation** menu, select **Archive Retrieve** to open the **Source Client** window.
4. Select a client to retrieve the archived data from and click **OK**. The **Archive Retrieve** window opens.
5. For the **Annotation String** attribute, type all or part of the annotation assigned to the save set when it was archived.

Note: If no annotation is entered, all archived save sets for the client appear.

6. Click **OK**. The **Save Sets** dialog box opens.
7. From the **Save Sets** dialog box, perform either of these functions, if necessary:
 - To view a list of volumes required to retrieve the data from this archived save set, click **Required Volumes**.

- To type a new path for the location of the recovered data and to indicate what the NetWorker server should do when it encounters duplicate files, click **Recover Options**.
8. Select the archived save set to retrieve and click **OK**. The **Retrieve Status** window appears.

Note: You can also recover archived save sets by using save set recovery. [“Recovering by save set selection” on page 325](#) provides more information.

Retrieving nonindexed archives from a client on UNIX

Data that was archived with a nonindexed archive pool (such as the Archive pool) must be retrieved by the entire save set rather than by file selection.

To retrieve nonindexed archived data:

1. Mount the archive volume in the appropriate storage device.
2. Start the **nwrecover** program. Type:

```
nwrecover -s servername
```

where *servername* is the name of the server to use when recovering save sets. The */servers* file, located in */nsr/res/servers*, contains an entry for each available server.

If the **-s** option is not entered and there is only one server detected, that server will be connected to automatically. If there are no servers detected, or if there is more than one server available, the Change Server dialog box appears, which allows you to choose the server.

After the server is specified, the **nwrecover** program displays.

3. From the **Options** menu, select **Recover Archived Save Sets**.
4. Mark the save sets to be recovered by selecting the save sets and clicking the **Mark** button.
5. Click the **Start** button on the toolbar.

Recovering indexed archive data from a client on Windows

Data archived by using the Indexed Archive pool and the PC Archive pool maintain information in the client file index about the individual files in the save set.

The archived files are recovered the same way as nonarchived files. To recover indexed archived files, the archive must have been saved by using the Indexed Archive pool, PC Archive pool, or be a custom archive pool with the Store Index Entries attribute in the Pool resource enabled.

To recover indexed archived data:

1. Start the NetWorker **User** program.
2. Click **Recover** to open the **Source Client** dialog box.
3. Select the source client whose data is to be recovered, and click **OK**. The local client is the default selection.
4. Select the destination client for the recovered data, and click **OK**. The local client is the default selection.

5. Select the files to be recovered and click the **Mark** button.
6. Click **Start**.

Recovering indexed archive data from a client on UNIX

Data archived by using the Indexed Archive pool and the PC Archive pool maintain information in the client file index about the individual files in the save set.

To recover indexed archived files, the archive must have been saved by using the Indexed Archive pool, PC Archive pool, or be a custom archive pool with the Store Index Entries attribute in the Pool resource enabled.

To recover indexed archived data:

1. Start the **nwrecover** program. Type:

```
nwrecover -s servername
```

where *servername* is the name of the server to use when recovering the data. The */servers* file, located in */nsr/res/servers*, contains an entry for each available server.

If the **-s** option is not entered and there is only one server detected, that server will be connected to automatically. If there are no servers detected, or if there is more than one server available, the **Change Server** dialog box appears, allowing you to choose the server.

After the server is specified, the **nwrecover** program appears.

2. From the **Options** menu, select **Recover Archived Files**.
3. Mark the files to be recovered by selecting the files and clicking **Mark**.
4. Click **Start**.

Retrieving archive data from the command prompt

One can also retrieve archive save sets by using the **nsrretrieve** command. For more information, refer to the *EMC NetWorker Command Reference Guide* or the UNIX man pages.

To identify an archive for retrieval, use the **-A** option to specify an annotation for the archive. However, when you use the **-A** option you must specify a string that uniquely identifies one annotation.

Example 24 Using the nsrretrieve command

In this example, suppose that archive A is annotated with *Accounting_Fed* and archive B is annotated with *Accounting_Local*.

- ◆ If you type this command:

```
nsrretrieve -A Accounting
```

No match is found and no archive is retrieved.

- ◆ If you entered this command:

```
nsrretrieve -A ting_L
```

Archive B is located.

Archive request management

This section describes how to work with scheduled archive requests.

Starting a scheduled archive at any time

You can start a scheduled archive immediately rather than wait for the scheduled start time.

To start a scheduled archive:

1. In the **Administration** window, click **Monitoring**.
2. Select the **Archive Requests** tab.
3. Right-click the archive request and select **Start**.

Stopping a scheduled archive while in progress

To stop an archive request in progress:

1. In the **Administration** window, click **Monitoring**.
2. Right-click the archive request and select **Stop**.

Disabling a scheduled archive

To disable an archive request:

1. In the **Administration** window, click **Monitoring**.
2. Right-click the archive request and select **Disable Archive**.

Viewing details of a scheduled archive

To open the **Archive Request Details** window:

1. In the **Administration** window, click **Monitoring**.
2. Right-click the archive request and select **Show Details**.

The **Archive Request Details** window provides information about the completion of an archive request:

- ◆ The **Completion Time** displays the time the archive finished. This is the difference between the completion and start times of the archive.
- ◆ The success of the archive request is either completed, failed, or partial.

This chapter covers these topics:

◆ Overview of cloning	218
◆ Save set cloning	218
◆ Specifying browse and retention policies for clone data	226
◆ Volume cloning	227
◆ Recovering cloned data	227
◆ Cloning archived data	229
◆ Directing clones to a special storage node	229
◆ Using file type devices for clone operations	233
◆ Backup-to-tape for Avamar deduplication clients	233
◆ Cloning with Data Domain devices	233
◆ Using the nsrclone command	234

Overview of cloning

Cloning allows for secure offsite storage, transfer of data from one location to another and verification of backups. Cloning can be performed on volumes and on save sets.

Information about the volumes, status, and history of cloning operations can be viewed and monitored from the Administration window. Clone-related messages are also logged to the NetWorker message file and the savegrp log file, which are located in the <NetWorker_install_dir>\logs directory. [“Viewing log files” on page 663](#) provides information about viewing log files.

There are two main methods of cloning:

- ◆ Save set cloning:
Save sets can be cloned based on a schedule or on-demand by manual selection. [“Save set cloning” on page 218](#) provides more information.
- ◆ Volume cloning:
Backup volumes can be cloned on demand by manual selection. [“Volume cloning” on page 227](#) provides more information.

Note: Cloning works differently for deduplication devices. The *NetWorker Avamar Integration Guide* and the *NetWorker Data Domain Depulication Devices Integration Guide* provides more information.

Cloning requirements

The following requirements apply when performing cloning operations:

- ◆ A minimum of two storage devices must be enabled: one to read the existing data and one to write the cloned data:
 - If libraries with multiple devices are used, the NetWorker server mounts the volumes required for cloning automatically.
 - If stand-alone devices are used, mount the volumes manually. A message displays in the Alert tab of the Monitoring option that indicates which volumes to mount.
- ◆ The destination volume must be a different volume from the source volume, and must belong to a clone pool.
- ◆ You must be a member of the NetWorker Administrators group. [“NetWorker User Groups” on page 442](#) provides information.
- ◆ Only one clone of a particular save set can reside on a single volume. Therefore, if three clones of the same save set are specified, each clone is written to a separate volume.

Save set cloning

Prior to NetWorker 7.6 Service Pack 1, the user interface options to set up a scheduled clone operation were limited in flexibility and were prone to performance issues. These types of scheduled clones were linked to regular backup group operations and were enabled through the backup group resource. The only option to get around these limitations was to use the **nsrclone** command with scripted solutions.

In NetWorker 7.6 Service Pack 1 and later, a new Clone user interface option is available for scheduled clone operations. The new clone option has most of the flexibility of the **nsrclone** command and avoids the performance limitations often associated with the legacy automatic cloning method.

The following topics are included in this section:

- ◆ [“Considerations for scheduled clone jobs” on page 219](#)
- ◆ [“Setting up a schedule clone job” on page 220](#)
- ◆ [“Starting a scheduled clone job manually” on page 222](#)
- ◆ [“Monitoring scheduled clone jobs” on page 222](#)
- ◆ [“Setting up automatic cloning from a backup group” on page 222](#)
- ◆ [“Viewing the clone status of a save set” on page 223](#)
- ◆ [“Cloning a save set manually” on page 223](#)
- ◆ [“Additional manual clone operations” on page 225](#)

Considerations for scheduled clone jobs

Be aware of the following considerations when setting up scheduled clone jobs:

Scheduling multiple clone jobs to start at the same time

Do not schedule more than 30 clone jobs to start at the same time. Scheduling 30 or more clone jobs to occur at the same time may result in some clone jobs timing out and not completing.

Mixing save sets from different source devices

Clone operations that mix save sets from different source devices, such as Data Domain devices, AFTD devices, or NDMP devices, may be written to different target volumes. Although this behavior is by design, you may prefer to write all save sets in the clone operation to the same clone volume.

If the clone operation includes save sets from different devices, and you want all save sets to be written to the same volume, include only one volume in the clone target pool.

Unmounted clone source volumes on remote storage nodes

If the clone source volume is on a remote storage node and is unmounted, attempting to start a regular volume clone operation will not complete successfully, even if the source volume is mounted after the clone operation attempts to start. The clone program **nsrclone** will hang with the following message:

```
Server <server_name> busy, wait 30 second and retry
```

This issue does not occur in the following situations:

- ◆ If the storage node is on the NetWorker server, that is, when the storage node is not remote.
- ◆ If performing a clone controlled replication (optimized clone) operation.

PowerSnap module and scheduled cloning

To set up a scheduled clone for a PowerSnap module backup, you must specify the backup group to which the PowerSnap backup belongs. When setting up a scheduled clone job, specify the backup group in the **Save Set Filters** tab.

Clone resources that are created with the nsradmin program

Clone resources (known as NSR clone resources) that are created with the **nsradmin** command line program cannot be edited as scheduled clone resources in the NetWorker Administration graphical user interface.

To avoid this issue, perform one of the following:

- ◆ Create scheduled clone resources in the Administration interface. [“Setting up a schedule clone job” on page 220](#) provides more information.
- ◆ If you must create a NSR clone resource with the **nsradmin** program, create a corresponding NSR task resource with the **nsradmin** program. Together, these resources will enable you to edit the clone item as a scheduled clone resource in the GUI. The corresponding NSR task resource must have its **name** and **action** attributes specified as follows:

- **name:** `clone.nsrclone_resource_name`
- **action:** `NSR clone:nsrclone_resource_name`

For example, if the NSR clone resource was named *TestClone1*, the **name** and **action** attributes of the NSR task resource would be:

- **name:** `clone.TestClone1`
- **action:** `NSR clone: TestClone1`

These entries are case-sensitive.

Setting up a schedule clone job

To set up a scheduled clone operation:

1. From the **Administration** window, click **Configuration**.
2. In the expanded left pane, select **Clones**.
3. From the **File** menu, select **New**.
4. In the **Name** attribute, type a unique name to identify the scheduled clone resource. Type additional information in the **Comment** attribute if necessary.
5. If you wish to override the saveset’s original browse and retention policies, select new policies in the **Browse** and **Retention** policies attributes.
6. To specify the storage node that will write data during the clone operation, select a storage node from the **Storage node to WRITE save sets** attribute. If a selection is made in this attribute, it will override any selection criteria that is described in [“Storage node selection criteria for writing the clone” on page 231](#).

This attribute is used primarily in conjunction with the **Storage node to READ save sets** attribute to balance access to storage media across different storage nodes.

7. To specify the storage node that will read data during the clone operation, select a storage node value from the **Storage node to READ save sets** attribute. This attribute is visible only when Diagnostic mode is selected. Additionally, the selected storage node must be included in at least one of the following:
 - The **Recover storage nodes** or **Storage nodes** attribute of the NetWorker server’s client resource.
 - The storage node listed in the **Read Hostname** attribute for the library resource, if a library is being used.

- A storage node on which any device in the library is configured, if a library is being used.

This attribute is used primarily in conjunction with the **Storage node to WRITE save sets** attribute to balance access to storage media across different storage nodes and is not intended for use with standalone devices such as AFTD's, file type devices, Data Domain devices, and so on.

8. To specify the clone media pool to write data to during a clone operation, select a clone type media pool from the **Write clone data to pool** attribute. If no selection is made, clones will be written to the default clone pool.

Pools are used to direct backups to specific media volumes. This attribute is particularly useful when you want to ensure that only certain media types are used to hold clone data. For example, to ensure that this clone job only replicates to a certain type of disk, such as a Data Domain type disk, select a clone pool that uses only Data Domain type disks. Likewise, to ensure that this clone job only replicates to tape (tape out), select a clone pool that uses only tape devices.

9. Select **Continue on save set error** to force NetWorker to skip invalid save sets and to continue the clone operation. If this option is not selected (default setting), an error message will be generated and the clone operation will not continue if an invalid save set or invalid volume identifier is encountered.
10. To restrict the number of clone instances that can be created for any save set that is included in this particular scheduled clone operation, type a value in the **Limit number of save set clones** attribute. A value of zero (0) means that an unlimited number of clones may be created for this scheduled clone operation.

Consider limiting the number of save set clones in cases where the clone operation has not completed and is being retried. For example, if you type a value of **1** in this attribute and then retry a partially completed clone operation, only the save sets that were not successfully cloned the first time will be eligible for cloning. In this way, unnecessary clone instances will not be created.

Regardless of the value in this attribute, NetWorker always limits the number of save set clone instances to one per volume. A clone pool can have multiple volumes. This attribute limits the number of save set clone instances that can be created for a clone pool in a particular scheduled clone operation.

11. Select **Enable** to allow the clone job to run at its scheduled time.
12. In the **Start Time** attribute, click the up and down arrows to select the time to start the clone job. Alternatively, type the time directly into the attribute fields.
13. From the **Schedule Period** attribute, select **Weekly by day** or **Monthly by day** depending on how you want to schedule the clone job and then select the day(s) of the week or month on which the scheduled clone is to occur.
14. To repeat the clone job within a day, specify an **Interval** time in hours. For example, if the start time is **6 AM**, and the interval is **6 hours**, then the clone job will run at 6 AM, 12 PM, and 6 PM.

If the **Limit the number of save set clones** value is set, then the repeat clone job will fail after the limit is reached.

15. Select the **Save Set Filters** tab to specify the save sets to be included in this scheduled clone job.
16. Select **Clone save sets that match selections** to limit save sets by various filter criteria or select **Clone specific save sets** to explicitly identify the save sets to be cloned.

To clone save sets that match selection criteria:

- Specify selection criteria to limit the save sets that will be included in this scheduled job. You can select the following criteria:
 - Groups (save groups)
Required for PowerSnap clones.
 - Clients (client resources)
 - Pools (backup pools)
 - Filter save sets by level (backup level)
 - Filter save sets by name (save set name as specified in the client resource)
 - Include save sets from the previous (save sets from the past number of days, weeks, months, or years)

To display a list of the save sets that will be cloned based on the filter criteria that you specified, select **Preview Save Set Selection**.

To clone specific save sets:

- Type the specific save set ID/ clone ID (ssid/clonid) identifiers in the **Clone specific save sets** list box. Type each ssid/cloneid value on a separate line.
You can query save set IDs / clone IDs through the Administration > Media user interface or by using the **mminfo** command. [“Querying the media database” on page 457](#) provides more information.

17. Select **OK** to save the scheduled clone job.

Starting a scheduled clone job manually

You can start a scheduled clone job at any time without affecting the regularly scheduled start time.

To start a scheduled clone job manually:

1. From the **Administration** window, click **Configuration**.
2. In the expanded left pane, select **Clones**.
3. Right-click on a clone resource in the right-pane and select **Start**.

You can also start a scheduled clone from the NetWorker Monitoring feature, which is described in [“Clones window” on page 396](#).

Monitoring scheduled clone jobs

You can view the status of scheduled clone jobs in the Monitoring window. You can view the scheduled clone’s last start and end time and you can view the completion status of each save set that is included in the scheduled clone. [“Clones window” on page 396](#) provides more information.

Setting up automatic cloning from a backup group

You can use the legacy method for setting up an automatic clone operation based on the backup group resource. The clone operation will begin after all of the backups for the group have completed. All of the save sets that are associated with the group will be backed up. However, be aware that this method lacks the flexibility of the method described in [“Setting up a schedule clone job” on page 220](#).

To automatically clone the save sets that belong to a group resource:

1. From the **Administration** window, click **Configuration**.
2. In the expanded left pane, select **Groups**.
3. Select the group in the right-pane.
4. From the **File** menu, select **Properties**.
5. In the Setup tab, select:
 - The **Clones** attribute
 - A value from the **Clone pool** attribute.

The clone operation will begin after all the save sets in the group have been backed up.

Viewing the clone status of a save set

To determine whether a save set on a volume has been cloned, or is itself a clone, check the Query Save Set tab window. [“Cloning a save set manually” on page 223](#) provides more information.

Cloning a save set manually

To manually clone a save set, first query the database, select the save set, and begin the cloning operation.

To manually clone a save set:

1. From the **Administration** window, click **Media**.
2. In the expanded left pane, select **Save Sets**.
3. In the right pane, select the **Query Save Set** tab. Use the **Query Save Set** tab to specify options to limit the range of save sets displayed. All query options are optional except for the date. A date range must be selected.

Note: The text boxes in the **Query Save Set** tab are case-sensitive.

4. Type values in any of these attributes to limit the search:
 - Client Name
 - Save Set
 - Save Set ID
 - Volume
 - Pool
5. Use the **Copies** attribute to limit the search to only those save sets that have already been cloned:
 - a. Select a boolean value of greater than (>), equal to (=), or less than (<) from the list.
 - b. Type the number of clones to complete the search criteria for the **Copies** attribute.

For example, to search for only those save sets that have been cloned at least twice, select greater than (>) and then type 1 as the number of copies.

6. Use the **Save Time** attribute to limit the search to a period of time in which the save set was created.

By default, yesterday is used for the start date, and today is used for the end date. This means that save sets backed up between yesterday at 12:01 A.M. and the current time will be displayed.

For the **From** and **To** date fields, any of these formats are acceptable:

- Written out completely (for example, November 1, 2009)
- Numerically as mm/dd/yy (for example, 11/01/09)
- Date and time selection from the list.

A long date range may result in too many selected save sets. This can increase response time or even require that you close and reopen the browser connection to the NetWorker Console.

7. Use the **Status** attribute to limit the search to save sets that have a particular status. [Table 34 on page 224](#) lists the values that can be selected.

Table 34 Save set status settings

Status	Description
All	Select all options listed under Select from in the Status area.
Select from	Select one or more of the following options: <ul style="list-style-type: none"> • Browsable: Select if the save set still has an entry in the client file index. • Recyclable: Select if all save sets have passed both the browse and retention policy time periods; the volume may now be available for automatic relabeling and overwriting (provided all save sets on the volume are recyclable). • Recoverable: Select if the entry for the save set has been removed from the client file index, but is still available for recovery from the media (that is, the volume has not passed its retention policy). • In-progress: Select if the save set is currently in the process of being backed up. In-progress save sets cannot be cloned. • Aborted: Select if the save set was either aborted manually by the administrator during a backup, or because the computer crashed. Aborted save sets cannot be cloned. • Suspect: Select if a previous attempt to recover the save set failed.

8. Use the **Maximum Level** attribute to limit the search to save sets of a particular backup level.

The level All is specified by default. All the levels up to and including the selected level are displayed. For example:

- If you select level 5, save sets backed up at levels full, 1, 2, 3, 4, and 5 are displayed.
- If you select level Full, only those save sets backed up at level full are displayed.
- If you select All, save sets for all levels are displayed.

9. Click the **Save Set List** tab.

The save sets that fit the criteria appear in the **Save Sets** list.

10. Select the save sets to clone from the **Save Set** list.

11. From the **Media** menu, select **Clone**.

12. From the **Target Clone Media Pool** list, select a clone pool.

13. Click **OK**, then click **Yes** on the confirmation screen.

[“Viewing manual clone history” on page 225](#) provides information on viewing the status of a manual clone operation or to cancel a clone operation that is in progress.

Example 25 Manual cloning of a save set

In this example, a user has requested that the NetWorker administrator manually clone several save sets that are not included in an automatic cloning schedule.

The user must send the data to another company located out of country. The administrator must clone the most recent full backup, and any incrementals since the last full backup, to make sure that the most current data is sent.

To clone the save set, the NetWorker administrator must have this information:

- ◆ NetWorker client name
- ◆ Name of the save set
- ◆ Date the data was backed up

To manually clone the save sets:

1. From the **Administration** window, click **Media**.
2. In the expanded left pane, select **Save Sets**.
3. In the right pane, select the **Query Save Set** tab.
4. In the **Client Name** attribute, type the client name.
5. In the **Save Set** attribute, type the save set name.
6. For the **Start Date** and **End Date**, type the dates used for the search.

Note: In this case, the administrator does not need to change or select any status choices other than the defaults.

7. Click the **Save Set List** tab. All save sets that meet the selection criteria appear in the **Save Sets** list.
8. Select the save sets to clone.
9. From the **Save Set List**, determine the size of the data and the original volume that contains the data to be cloned.
10. Mount the original volume.
11. From the **Media** menu, select **Clone**.
12. From the **Target Clone Media Pool** list, select a clone pool.
13. Click **OK** and then click **Yes** on the confirmation screen.

Additional manual clone operations

This section covers operations that can be performed on both volumes and save sets that have been manually cloned. [“Volume cloning” on page 227](#) or [“Save set cloning” on page 218](#) provide information about manually cloning a volume or save set.

Viewing manual clone history

To view history information about manual clone operations:

1. From the **Administration** window, click **Monitoring**.
2. From the **Monitoring** menu, select **Show Manual Clone History**.

A dialog box appears that shows manual clone history information.

Stopping a manual clone operation

To stop a manual clone operation that is in progress:

1. From the **Administration** window, click **Monitoring**.
2. From the **Monitoring** menu, select **Show Manual Clone History**.
3. Select the clone operation to be stopped.
4. Click **Stop Selected Operation**.

The manual clone operation is stopped.

Specifying browse and retention policies for clone data

The browse and retention policy for clone data can be specified independently of the original save set. In this way, clone data can be browsed and recovered after the policies of the original save set have expired.

To specify the browse or retention policy for clone data, perform one of the following:

- ◆ Specify a browse and retention policy in a scheduled clone job
- ◆ Specify a retention policy in the Clone pool.
- ◆ Specify a retention policy from the command prompt.

Specify a browse and retention policy in a scheduled clone job

To specify a browse and retention policy in a scheduled clone job:

1. From the **Administration** window, click **Configuration**.
2. In the expanded left pane, select **Clones**.
3. From the **File** menu, select **Properties**.
4. Select new policies in the **Browse** and **Retention** policies attributes. When the scheduled clone job is next run, the cloned save sets will be given the new browse and retention policies.

Specify a browse and retention policy from the command prompt

To specify a retention policy from the command prompt, perform one of the following:

- ◆ Use the **nsrclone** command with the **-y** option when creating a clone save set.
- ◆ Specify a retention policy for an existing clone save set by using the **nsrmm -e** command.

To specify a browse policy from the command prompt:

- ◆ Use the **nsrclone** command with the **-w** option when creating a clone save set. However, be aware that this will also change the browse policy of the original save set instance if the original save set's browse time has not passed and is earlier than the new browse time for the clone.

Specify a retention policy for a Clone pool

You can only specify a retention policy for cloned data in a pool resource.

To specify a retention policy for a Clone pool:

1. In the clone pool to which clone backups will be directed, select the **Configuration** tab.
2. From the **Retention** policy list, select a retention policy, then click **OK**.

“[Configuring media pools](#)” on page 189 provides information about editing or creating a pool.

Note: Retention policies that are specified in a scheduled clone job or from the command prompt, override the retention policy specified in a clone pool.

Volume cloning

Volume cloning is the process of reproducing complete save sets from a storage volume to a clone volume. You can clone save set data from backup or archive volumes.

Creating a clone volume

To create a clone volume:

1. From the **Administration** window, click **Media**.
2. In the expanded left pane, select **Volumes**.
3. In the right pane, select the volume to be cloned.
4. From the **Media** menu, select **Clone**.
5. From the **Target Clone Media** Pool list, select a clone pool.
6. Click **Ok**, then click **Yes** on the confirmation screen.

Viewing clone volume details

You can view the details of a clone volume, such as the amount of space used, mode, expiration date, pool, and save sets.

To view clone volume details:

1. From the **Administration** window, click **Media**.
2. In the expanded left pane, select **Volumes**.
3. In the right pane, details for each volume are displayed in the table.
4. To view save set information for a volume:
 - a. In the right pane, select a volume.
 - b. From the **Media** menu, select **Show Save Sets**.

Recovering cloned data

No special operation is required to recover cloned data. The volume, either a clone or original volume, that is selected for a recovery operation is determined as follows:

1. The highest priority is given to the volume (clone or original volume) that has a complete, non-suspect save set status. A complete save set that is suspect has a higher priority than an incomplete non-suspect save set.
[“Changing save set status within the Volume Save Sets window” on page 311](#) provides information about changing the status of a save set.
2. If the volumes still have equal priority, then priority is given to the mounted volume.
3. If the volumes are mounted, then priority is based on the media type. The media types from highest to lowest priority are:
 - a. Advanced file type device
 - b. File type device
 - c. Other (such as tape or optical)
4. If the volumes are not mounted, then priority is based on the media location. The media locations from highest to lowest priority are:
 - a. Volumes in a library
 - b. Volumes in an AlphaStor or SmartMedia controlled library
 - c. Volumes that are not in a library but are onsite (**offsite** flag is not set).
 - d. Volumes that are offsite (**offsite** flag is set)

Use the **nsrmm** command to specify that a volume is offsite. For example:

```
nsrmm -o offsite -V volume_id
```

The volumes required for recovery appear in the Required Volumes window of the **nwrecover** (UNIX, Mac) or NetWorker User (Windows) programs. [“Viewing the volumes required for data recovery” on page 324](#) provides more information.

You can also run the **scanner** program on a clone volume to rebuild entries in the client file index, the media database, or both. After you re-create the entries, normal recovery is available. [“Restore a save set entry in the online indexes” on page 338](#) provides more information.

Recovering a cloned save set from the command prompt

Recovery of a cloned save set can be performed at the command prompt, for example:

```
recover -S ssid/cloneid
```

The *EMC NetWorker Command Reference Guide* or the UNIX man pages provide more information about the **recover** command.

Recovering a save set when all cloned instances have expired

When all cloned instances of a save set have passed their retention period, the following procedure must be used to mark a save set as eligible for recovery:

1. Use the **nsrmm** command with the **-e time** option to change the retention time for the clone save set:

```
nsrmm -e time -S ssid/cloneid
```

If the *cloneid* is not identified with the **-S** option, the following error message is displayed:

Save set *ssid* cannot be marked as notrecyclable. Please specify the *ssid/cloneid* of the particular clone instance.

2. Use the **nsrmm** command with the **-o notrecyclable** option to instruct the media database that the save set is no longer expired:

```
nsrmm -o notrecyclable -s ssid/cloneid
```

If the **-o notrecyclable** option is used with **nsrmm** prior to changing the retention time as described in [step 1](#), the following error message is displayed:

```
nsrmm: Save set ssid:ssid cloneid:cloneid eligibility cannot be
cleared, retention time must be adjusted first
```

After this procedure has been completed, the save set is recoverable.

Cloning archived data

You can schedule a clone job to clone archive data or clone archive data on-demand.

To set up a scheduled clone job for archive data:

- ◆ Follow the steps in [“Setting up a schedule clone job”](#) on page 220 and select an archive pool as one of your save set filter criteria.

To clone an archive volume on-demand:

1. From the **Administration** window, click **Media**.
2. In the expanded left pane, select **Save Sets**.
3. In the right pane, select the **Query Save Set** tab.
4. In the **Pool** attribute, select an archive pool from the list. Make other selections, as appropriate, to limit the save set search criteria. [“Cloning a save set manually”](#) on page 223 provides more information.
5. Click the **Save Set List** tab.
6. Select the archive save sets to clone from the **Save Set** list.
7. From the **Media** menu, select **Clone**.
8. From the **Target Clone Media Pool** list, select an archive clone pool.
9. Click **OK** and then click **Yes** on the confirmation screen.

Directing clones to a special storage node

You can direct clone operations to a specific storage node. This section describes the criteria used to determine the storage node from which the clone data is read (read source) and the storage node to which the clone data is written (write source).

Storage node selection criteria for reading the clone data

The following logic is used to determine the storage node from which the clone data will be read (read source):

1. If the source volume is mounted, then the storage node of the device on which the volume is mounted is used as the read source.

- If the `FORCE_REC_AFFINITY` environment variable is set to **Yes**, the selection criteria in [step 1](#) is ignored and the selection criteria behaves as though the volume is not mounted as described in [step 2](#).
 - When cloning is used in a Virtual Tape Library (VTL) environment such as a CLARiON Disk Library (CDL), the NetWorker software behaves as if the `FORCE_REC_AFFINITY` environment variable is set to **Yes**.
2. If the volume is not mounted or if the `FORCE_REC_AFFINITY` environment variable is set to **Yes**, a list of eligible storage nodes is created. The list is based on the storage nodes that meet the criteria in both [step a](#) and [step b](#) that follow:
 - a. The storage nodes listed in the **Recover Storage Nodes** attribute of the NetWorker server's client resource. If this attribute is empty, the NetWorker server's **Storage Nodes** attribute is used.
 - b. If the requested volume is in a media library, the storage nodes on which the volume can be mounted are determined in the following manner:
 - The storage node listed in the **Read Hostname** attribute for the library resource is used.
 - If the **Read Hostname** attribute for the library resource is not set, then all storage nodes on which any device in the library is configured is added to the list of eligible storage nodes.
 - If the volume is not in a media library, then the list of storage nodes is based on [step a](#) only.

Example 26 Selecting a storage node read source

In this example, the volume resides in a media library and is not mounted. The **Recover Storage Nodes** attribute in the NetWorker server's Client resource lists the following storage nodes in order:

- ◆ Storage node F
- ◆ Storage node E
- ◆ Storage node D

The **Read Hostname** attribute for the library resource is not set, however, the following devices in the media library are configured with storage nodes:

- ◆ Device A is configured on storage node D
- ◆ Device B is configured on storage node E
- ◆ Device C is configured on storage node B

The list of eligible storage nodes is the intersection of the two previous lists. Therefore the list of eligible storage nodes is as follows:

- ◆ Storage node E
- ◆ Storage node D

The order in which the storage node is selected is based on the order of the **Recover Storage Node** attribute list. In this example, storage node E is selected first as the read source storage node. If storage node E is not available, then storage node D is selected.

In this example, if no matching storage nodes were found in the intersecting list, an error would be written to the daemon log file that indicates no matching devices are available for the operation. To correct the problem, make adjustments so that at least one matching storage node can be found in both lists. [“Viewing log files” on page 663](#) provides information about viewing log files.

Storage node selection criteria for writing the clone

The following criteria are used to determine the storage node to which the clone data will be written (write source):

1. The **Clone Storage Node** attribute of the read source storage node’s Client resource is used as the write source.
2. If the read source host does not have a Client resource, the **Clone Storage Node** attribute of the NetWorker server is used as the write source. Otherwise, the **Storage Nodes** attribute of the NetWorker server is used as the write source.

No matter where cloned data is directed, the client file index and media database entries for the cloned save sets still reside on the NetWorker server. This ensures that browse and retention policies are handled consistently regardless of where the clone data was directed.

Directing a clone from one storage node to another storage node

To direct a clone from one storage node to another:

1. Open the **Client** resource for the read source storage node. [“Editing a client” on page 470](#) provides more information.
2. Click the **Globals (2 of 2)** tab.
3. In the **Clone Storage Nodes** attribute, add the hostname of the storage node to which the clone data will be written. The first entry in the list that has a functional, enabled device will receive the cloned data from the read source storage node.

The **Clone Storage Nodes** attribute applies only to NetWorker servers and storage nodes. Leave this attribute blank for NetWorker clients that are not also NetWorker servers or storage nodes.

Directing clones from all storage nodes to a single storage node

To direct clones from all storage nodes to a single storage node:

1. On the **Client** resource for each storage node, leave the **Clone Storage Nodes** attribute blank.
1. Open the **Client** resource for the NetWorker server. [“Editing a client” on page 470](#) provides more information.
2. Click the **Globals (2 of 2)** tab.
3. In the **Clone Storage Nodes** attribute, add the hostname of the storage node to which all cloned data is to be written.

Storage node selection criteria for recovering cloned data

The following logic is used to determine the storage node from which the clone data will be recovered:

1. If the source volume is mounted, then the storage node of the device on which the volume is mounted is used as the read source.

If the `FORCE_REC_AFFINITY` environment variable is set to **Yes**, the selection criteria in [step 1](#) is ignored and the selection criteria behaves as though the volume is not mounted as described in [step 2](#).

When cloning is used in a Virtual Tape Library (VTL) environment such as a CLARiiON Disk Library (CDL), the NetWorker software behaves as if the `FORCE_REC_AFFINITY` environment variable is set to **Yes**.

2. If the volume is not mounted or if the `FORCE_REC_AFFINITY` environment variable is set to **Yes**, a list of eligible storage nodes is created. The list is based on the storage nodes that meet the criteria in both [step a](#) and [step b](#) that follow:
 - a. The storage nodes listed in the **Recover Storage Nodes** attribute of the NetWorker client resource that is being recovered. If this attribute is empty, the NetWorker client's **Storage Nodes** attribute is used.
 - b. If the requested volume is in a media library, the storage nodes on which the volume can be mounted are determined in the following manner:
 - The storage node listed in the **Read Hostname** attribute for the library resource is used.
 - If the **Read Hostname** attribute for the library resource is not set, then all storage nodes on which any device in the library is configured is added to the list of eligible storage nodes.
 - If the volume is not in a media library, then the list of storage nodes is based on [step a](#) only.

Using file type devices for clone operations

This section discusses issues related to cloning with file type and advanced file type devices.

Differences in the cloning process

There are differences in the cloning process for the two types of devices:

- ◆ For file type devices, automatic and manual cloning begins only after all the save sets in a savegroup have been backed up.
- ◆ For advanced file type devices, automatic cloning begins only after all the save sets in a savegroup have been backed up. However, you can begin manually cloning a save set as soon as it has finished its backup.

Manual cloning with advanced file type device

In a situation where there are three save sets:

- ◆ Save set A has a size of 10 KB
- ◆ Save set B has a size of 10 MB
- ◆ Save set C has a size of 10 GB

When save set A has completed its backup, you can begin the manual cloning process while the other two larger save sets are still being backed up.

As each save set is backed up, you can launch the cloning process for that save set.

You can only clone one save set at a time.

Backup-to-tape for Avamar deduplication clients

The *NetWorker Avamar Integration Guide* provides more information.

Cloning with Data Domain devices

Data Domain devices were introduced in NetWorker 7.6 Service Pack 1 and enable one to perform clone controlled replication (optimized cloning) from one Data Domain device to another. You can also clone to tape or to any other device type.

Clone operations with Data Domain devices are set up in basically the same way as any other scheduled clone operation, which is described in [“Setting up a schedule clone job” on page 220](#). However, there are some special considerations to be aware of when setting up Data Domain devices. These are described in the *EMC NetWorker Data Domain Devices Integration Guide*.

Using the nsrclone command

As of NetWorker 7.5, the **nsrclone** command has been enhanced to provide greater flexibility in selecting save sets for cloning by clients, groups, save set names, save set levels, and by number of valid copies or clones not yet created in the target pool. Also, be aware that as of NetWorker 7.6 Service Pack 1, most of the functionality provided in the **nsrclone** command is now provided in the Clone resource user interface. “[Setting up a schedule clone job](#)” on page 220 provides more information.

[Table 35 on page 234](#) provides the descriptions of the new options, in NetWorker 7.5, that can be used with the **nsrclone** command.

Table 35 List of nsrclone options and their descriptions

Options	Description
-C <i>less than copies in target pool</i>	Specifies the upper non-inclusive integer limit such that only save sets with a lesser number of clone copies in the target clone pool are considered for cloning. This option is useful when retrying aborted clone operations. Because the target is a clone pool, each save set's original copy or clone is never considered when counting the number of copies of the save set. Likewise, any AFTD read-only mirror clone is not considered because its read or write master clone is counted and there is only one physical clone copy between the related clone pair. Recyclable, aborted, incomplete and unusable save set or clones are excluded in the counting. This option can only be used with the -t or -e option.
-l <i>level or range</i>	Specifies the level or n1-n2 integer range from 0 to 9 for save sets that are considered for cloning. Manual for ad-hoc or client-initiated save sets, full for level full save sets, incr for level incremental save sets, and integers 0 through 9, where save set0 also means full, can be used. More than one level can be specified by using multiple -l options and the -l n1-n2 range format. This option can only be used with the -t or -e option.
-N <i>save set name</i>	Specifies the save set name for save sets that are considered for cloning. More than one save set name can be specified by using multiple -N options. This option can only be used with the -t or -e option.
-c <i>client name</i>	Specifies the save sets in the particular client. More than one client name can be specified by using multiple -c options. This option can only be used with the -t or -e option.
-g <i>group name</i>	Specifies the save sets in the particular group. More than one group name can be specified by using multiple -g options. This option can only be used with the -t or -e option.

Examples The following examples show how various options can be used with the **nsrclone** command:

Copy all save sets created in the last twenty-four hours for clients *mars* and *jupiter* with save set names */data1* and */data2* for only backup level full:

```
nsrclone -S -e now -c mars -c jupiter -N /data1 -N /data2 -l full
```

Copy all save sets that were not copied to the default clone pool in a prior partially aborted **nsrclone** session:

```
nsrclone -S -e now -C 1
```

Copy all save sets that were not copied to the default clone pool in a previous partially aborted **nsrclone** session and with extended retention and browse periods:

```
nsrclone -S -e now -C 1 -y 12/12/2010 -w 12/12/2009
```

This chapter covers these topics:

- ◆ Save set staging..... 236
- ◆ Working with staging policies..... 236

Save set staging

Save set staging is the process of transferring data from one storage medium to another medium, and then removing the data from its original location. For example, the initial backup data can be directed to a high performance file type or advanced file type device. In this way, the backup time is reduced by taking advantage of a file or advanced file type device. At a later time, outside of the regular backup period, the data can be moved to a less expensive but more permanent storage medium, such as magnetic tape. After the backup data is moved, the initial backup data can be deleted from the file or advanced file type device so that sufficient disk space is available for the next backup.

A save set can be staged from one disk to another as many times as required. For example a save set could staged from disk 1, to disk 2, to disk 3, and finally to a remote tape device or cloud device. Once the save set is staged to a tape or cloud device, it cannot be staged again. However, you could still clone the tape or cloud volume.

Staging can be driven by any of the following:

- ◆ Calendar-based process, such as keeping the save set for 30 days on the staging device before moving the data to the next device.
- ◆ Event-based process, such as when available space in the staging pool drops below a set threshold. When this happens, the oldest save sets are moved until available space reaches a preset upper threshold.
- ◆ Administrator-based process, such as allowing the administrator to either reset the threshold or manually select save sets to stage.

Staging does not affect the retention policy of backup data. Therefore, staged data is still available for recovery.

When the **nsrstage** process encounters an error after successfully cloning specified save sets, it deletes only those successful save sets from the source volume before the program is aborted. This ensures that only a single set of save sets exist in either of the source or clone volumes after staging.

Working with staging policies

This section describes how to work with staging policies.

[Chapter 11 page 242](#) provides information on advanced file type device (AFTD) and file type (FTD) configuration. The *NetWorker Data Domain Deduplication Devices Integration Guide* provides more information on NetWorker data domain devices.

Creating a staging policy

Before creating a staging policy configure all appropriate devices. Otherwise, no devices will be listed in the Devices attribute.

To prevent an advanced file type device from becoming full during backup, the staging policy must be set up so that save sets are automatically moved to another medium to make disk space available in the advanced file type device.

To create a staging policy:

1. In the **Administration** window, click **Configuration**.

2. In the left pane, select **Staging**.
3. From the **File** menu, select **New**.
4. In the **Name** attribute, type a name for the staging policy.
5. In the **Comment** attribute, type a description of the staging policy.
6. To enable staging to begin immediately or to be invoked automatically at a later time, set the **Enabled** attribute to **Yes**.

Note: You can enable or disable staging at any time.

7. In the **Devices** attribute, select the file type and adv_file type devices as the source device for staging.

Note: The adv_file device and its corresponding _AF_readonly device will both be selected automatically, even if only one device was selected as the source of staging.

You can assign multiple devices to the staging policy, but a given device cannot be controlled by more than one staging policy.

8. For the **Destination Pool** attribute, select the destination pool for the staged data.

Note: The Default volume can only be staged to the Default or Default Clone pool. Similarly, the Default Clone volume can only be staged to the Default or Default Clone pool and Archive data can only be staged to the Archive Clone pool. The other volume types can be staged to any pool. If the Clone pool you have selected is restricted to storage node devices, you will also need to modify Clone Storage Node attribute of the Client resource for the NetWorker server to include the storage node name.

9. In the **High-Water Mark (%)** attribute, type or select a number.

This value is the point at which save sets should be staged, measured as the percentage of available space used on the file system partition that the file device is on. Staging continues until the low-water mark is reached (see [step 10](#)).

Note: The high-water mark must be greater than the low-water mark.

10. In the **Low-Water Mark (%)** attribute, type or select a number. This is the point at which the staging process will stop, measured as the percentage of available space on the file system partition that the file device is on.
11. From the **Save Set Selection** attribute, select from the list to determine the save set selection criteria for staging.
12. In the **Max Storage Period** attribute, type the number of hours or days for a save set to be in a volume before it is staged to a different storage medium.

Note: The Max Storage Period attribute is used in conjunction with the File System Check Interval attribute. Once the Max Storage Period value is reached, staging does not begin until the next file system check.

13. In the **Max Storage Period Unit** attribute, select **Hours** or **Days**.
14. In the **Recover Space Interval** attribute, type the number of minutes or hours between recover space operations for save sets with no entries in the media database from file or advanced file type devices.
15. In the **Recover Space Interval Unit** attribute, select **Minutes** or **Hours**.

16. In the **File System Check Interval** attribute, type the number of minutes or hours between file system checks.

Note: At every **File System Check** interval, if either the **High-Water Mark** or **Max Storage Period** has been reached, a staging operation is initiated.

17. In the **File System Check Interval Unit** attribute, select **Minutes** or **Hours**.
18. To invoke the staging policy immediately, complete this step. Otherwise, skip this step.
 - a. Select the **Operations** tab.
 - b. In the **Start Now** attribute, select one of these operations:
 - **Recover space** — Recovers space for save sets that have no entries in the media database and deletes all recycled save sets.
 - **Check file system** — Checks file system and stage data, if necessary.
 - **Stage all save sets** — Stages all save sets to the destination pool.

The selected operation applies to all devices associated with this policy.

Note: The choice you make takes effect immediately after clicking **OK**. After the staging operation is complete, this attribute returns to the default setting (blank).

19. When all the staging attributes are configured, click **OK**.

Editing a staging policy

To edit a staging policy:

1. In the **Administration** window, click **Configuration**.
2. In the left pane, select **Staging**.
3. In the right pane, select the **Staging** policy to edit.

Note: You cannot edit the name of an existing staging policy.

4. From the **File** menu, select **Properties**.
5. Make any necessary changes and click **OK**.

Copying a staging resource

To copy an Staging resource:

1. In the **Administration** window, click **Configuration**.
2. In the left pane, select **Staging**.
3. In the right pane, select the **Staging** resource to copy.
4. From the **Edit** menu, select **Copy**. The **Create Staging** dialog box appears, containing the same information as the Staging resource that was copied, except for Name attribute.
5. Type the name for the new **Staging** resource in the Name attribute, edit any other attributes as appropriate, and click **OK**.

Deleting a staging policy

Note: The Default staging policy cannot be deleted.

To delete a staging policy:

1. In the **Administration** window, click **Configuration**.
2. In the left pane, select **Staging**.
3. Remove all devices from the **Staging** policy.
 - a. In the right pane, select the **Staging** policy to be deleted.
 - b. From the **File** menu, select **Properties**.
 - c. In the **Devices** attribute, ensure that all listed devices are unselected.
 - d. Click **OK**.
4. In the right pane, select the **Staging** policy to be deleted.
5. From the **File** menu, select **Delete**.
6. When prompted, click **Yes** to confirm the deletion.

Consideration for staging a bootstrap backup

Bootstrap backups can be directed to a disk device such as an AFTD or FTD device. However, if a bootstrap backup is staged to another device, the staging operation will complete and will be reported as complete even though the "recover space" operation will not be executed. This means that the staged bootstrap will remain on the original disk from which it was staged. Therefore, the original disk can be used to scan in the bootstrap data if the staged bootstrap is accidentally deleted. Also be aware that if the bootstrap data is not staged from the original disk, the data on the original disk will be subject to the same browse and retention policies as any other saveset backup and will, therefore, be subject to deletion after the retention policy has expired.

Staging and cloning from the command prompt

Staging a save set from the command prompt works differently than staging a save set from the NetWorker Console. When staging from the NetWorker Console, you select save sets that belong to a single device. When staging from the command prompt, specify the save set IDs to be staged.

When a save set is cloned, the cloned save sets are given the same save set ID as the original save set with a new clone ID. When staging a save set from the command prompt, the NetWorker software stages all the save sets with the specified save set ID and then removes those save sets. That means that any cloned versions of the save set are removed when the original is removed.

To ensure that all clones are not removed, specify a clone ID with the save set ID to indicate the source volume of the staging. For example:

```
nsrstage -m -S ssid/cloneid
```

To find the clone ID of a save set, use the **mminfo** command. For example:

```
mminfo -avot -r "volume,ssid,cloneid,name"
```

For information about **nsrstage** or **mminfo**, refer to the *EMC NetWorker Command Reference Guide* or the UNIX man pages.

This chapter covers these topics:

◆ Overview of device operations	242
◆ File type (FTD) and advanced file type (AFTD) devices	242
◆ Creating and configuring FTDs and AFTDs.....	247
◆ Create CIFS-mounted AFTD on Windows servers and storage nodes	258
◆ Recover savesets by using AFTD concurrent operations	260
◆ Recover savesets by using AFTD concurrent operations	260
◆ Delete FTD and AFTD.....	261
◆ License NetWorker DiskBackup solutions	261
◆ Device target and max sessions default values and ranges	261
◆ Compatible block size for UNIX and Windows	261
◆ Library device maintenance	262
◆ Device parameter settings.....	265
◆ Common device interface	268
◆ Device ordering	269
◆ Nonrewinding tape device usage (UNIX/Linux only)	272
◆ Block-size mode (UNIX/Linux only).....	272
◆ Silos	272
◆ Miscellaneous device operations	277
◆ Tips for using libraries.....	280

Overview of device operations

[Chapter 12, “Media Management”](#) provides information on operations involving storage media.

You can view and access all libraries in the enterprise by selecting the Libraries option in the Console window. The Libraries option displays a hierarchy of NetWorker servers, configured NetWorker storage nodes, and devices that exist in the enterprise. The library information displayed is updated periodically or when a user requests it. Library information is also updated when NetWorker servers are added to, or deleted from, the enterprise hierarchy.

The details describing a particular device can be viewed, and often changed, in the device’s Properties.

To see the full range of settings and options available in the Properties window, select **View > Diagnostic Mode**. For a description of the various fields and attributes on a given Properties tab, click **Field Help**.

As with other Console functions, users can view and work with only those NetWorker servers for which they have access permission.

File type (FTD) and advanced file type (AFTD) devices

The NetWorker DiskBackup solution reduces the time it takes to save and recover data when compared to the use of tape. NetWorker DiskBackup allows data to be saved to a computer’s local or network-attached disk, instead of using a tape device to write the data to storage media. The DiskBackup solution requires a DiskBackup option license.

NetWorker DiskBackup supports these configurations:

- ◆ A local disk on a NetWorker storage node is supported for both file type devices (FTDs) and advanced file type devices (AFTDs).
- ◆ A network-attached disk device that is NFS-mounted to a UNIX version of the NetWorker storage node. This is supported for both file type devices and AFTDs.
- ◆ A network-attached disk device that is CIFS-mounted to a NetWorker storage node running on Microsoft Windows. This is supported only on AFTDs.

[“Differences between FTDs and AFTDs” on page 244](#) provides information on the key differences between file type and AFTD devices.

Example 27 NetWorker DiskBackup within a system configuration

[Figure 27 on page 243](#) illustrates how to use NetWorker DiskBackup within a system configuration. In this example:

- ◆ The AFTDs are created on Disk Device 1, Disk Device 2, and the Local Disk is created on storage node A.
- ◆ A file type device is created on Local Disk 2.
- ◆ Linux/UNIX storage node A writes its backups to one of the following:
 - The AFTD through an NFS connection to Disk Device 1.
 - The AFTD on Local Disk 1.

- ◆ The Microsoft Windows storage node B uses a CIFS connection to back up to the AFTD on Disk Device 2. The file type device cannot be used on a CIFS connection.
- ◆ The Microsoft Windows Storage Node C writes its backups to the file type device on the Local Disk 2.

NetWorker DiskBackup can be tailored to the specific configuration of the system.

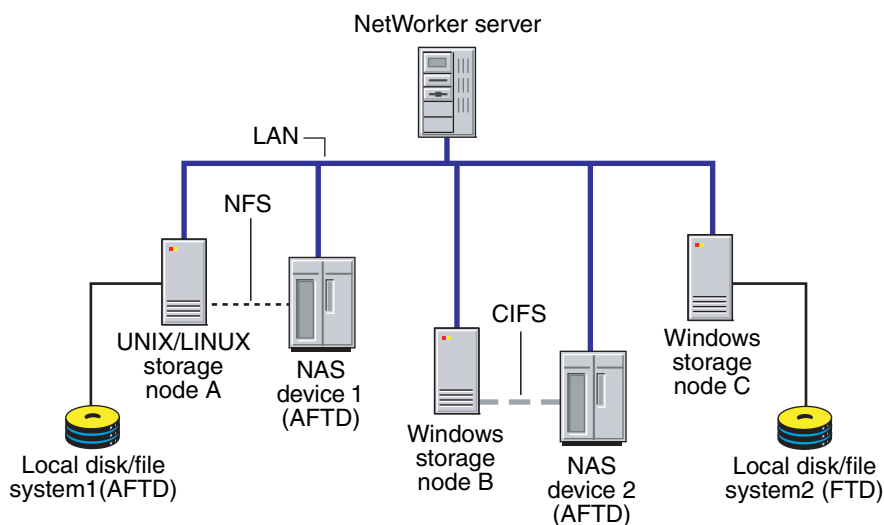

Figure 27 Sample NetWorker DiskBackup configuration

DiskBackup and staging

To prevent the file system from becoming full when backing up data to FTDs or AFTDs, a staging policy must be created to move the data off the disk as soon as possible. To make space for additional backups, perform one of these activities:

- ◆ Set up a staging policy.
- ◆ Review and, if required, modify the retention policy of the save sets.

Save set staging is helpful when used with either of these device types. [“Save set staging” on page 236](#) provides more information.

Differences between FTDs and AFTDs

Table 36 lists the functional differences between the file type device and the AFTD.

IMPORTANT

Data loss will result if a full FTD is made appendable while there is a backup pending completion with a save set partially written to the full FTD. In this case, the partial save set (currently in "incomplete" state) will be overwritten.

Table 36 Advanced file type and file type device differences (1 of 2)

Function or operation	AFTD	File type device
Create a device	Select media type: adv_file UNIX/Linux: local or NFS Windows storage node: <ul style="list-style-type: none"> Local or Common Internet File System (CIFS) Universal Naming Convention (UNC) path for CIFS: <ul style="list-style-type: none"> Remote user Password 	Select media type: file UNIX/Linux: local or NFS. Windows storage node: local path only
Label a device	<ul style="list-style-type: none"> Volume name must not exceed 60 characters. Automatically creates an <code>_AF_readonly</code> device, then labels and automounts (enables) a volume with a <code>.RO</code> suffix. 	<ul style="list-style-type: none"> Volume name must not exceed 63 characters.
Concurrent operations: "Recover savesets by using AFTD concurrent operations" on page 260 provides more information.	Yes	No
Save set ID/clone ID: "Recover savesets by using AFTD concurrent operations" on page 260 provides more information.	<ul style="list-style-type: none"> One save set ID with two clone IDs created for each save set. A second (virtual) clone created on <code>_AF_readonly</code> device. User can specify virtual clone ID for concurrent operations. 	One save set ID created with one clone ID for each save set.
Reclaiming or recovering space	<ul style="list-style-type: none"> Aborted save sets immediately removed. The <code>nsrim</code> program removes expired save sets, once every 24 hours, from the media database after a savegroup is completed (if volume recycle is set to Auto). Space on the AFTD is removed at the interval defined in the Reclaim Space Interval of the staging policy. 	The <code>nsrim</code> program removes both aborted and expired save sets, once every 24 hours, after a savegroup is completed (if volume recycle is set to Auto).
Volume default capacity for devices	Does not apply.	If the file type device was used prior to setting the Volume Default Capacity attribute, the data for that file type device must be staged or cloned to another device.
AFTD Percentage Capacity	A configurable setting for determining at what capacity the NetWorker software should stop writing to an AFTD spans from 1 to 100%.	Does not apply.

Table 36 Advanced file type and file type device differences (2 of 2)

Function or operation	AFTD	File type device
When file system or volume is full	<ul style="list-style-type: none"> • Message displayed stating file system requires more space. • The nsrim program invoked to reclaim space for expired save set on AFTD. • Notification sent by email stating device is full. • Device waits until space become available. The volume is never marked as full. 	<ul style="list-style-type: none"> • Waiting message displayed if no writable volume available or until volume becomes available. • Volume marked full and is no longer available for backups until the volume becomes appendable.
Save set continuation	No. Save sets that start on an AFTD must be completed on the same device.	Yes
Save set consolidation	Not supported.	Supported
Data format in device	Save stream (uasm) format (uses less space).	EMC Open Tape Format (OTF).

Differences in the cloning process

For both FTDs and AFTDs, save sets are cloned one at a time. Important differences exist, however, in the cloning process for the two types of devices:

- ◆ For file type devices, both automatic and manual cloning begins only after all the save sets in a savegroup are backed up.
- ◆ For AFTDs, automatic cloning begins after the save sets are backed up. Manual cloning of a save set can, however, begin as soon as it has finished its backup.
- ◆ For AFTDs, two simultaneous **clone** operations can be run from the command-prompt, as long as no **backup**, **recover**, or **stage** operations are running at the same time. The syntax is as follows:
 - **nsrclone -S [ssid/cloneid1]**
 - **nsrclone -S [ssid/cloneid2]**

The *EMC NetWorker Command Reference Guide* or the UNIX man page provides information about the **nsrclone** command.

File type devices

Configure the NetWorker server to back up data to a file type device by creating a new Device resource in the same way as for any other storage device.

The following restrictions apply to the configuration of a file type device:

- ◆ Multiple file type devices can be supported on a system. Each device must, however, have a different name.
- ◆ Dynamic Drive Sharing is not supported.
- ◆ To use multiple file type devices on the same disk, partition the disk and create only one file type device per partition.
- ◆ For most device types, the Volume Default Capacity attribute is an arbitrary value that is an estimate of what the volume capacity is likely to be. It has no impact on how much data is actually written to a volume. If the value is not set correctly, the percent used calculation will not be correct. For file type devices, the Volume Default Capacity is a hard limit to the amount of data that can be written to the device.

IMPORTANT

To avoid accidentally filling a file system, set the Volume Default Capacity attribute to restrict the size of the file type device. For example, if a Volume Default Capacity of 100 MB is set for a file type device, then the device will be marked full when the capacity of 100 MB is reached. This is true for any type of file system.

If the Volume Default Capacity of a volume changes, the changes do not take effect until the volume is relabeled, the directory contents are deleted, and the file device is re-created.

In the Console **Administration** interface, the Volume Default Capacity displays in the **Configuration** tab of the **Properties** window of a device when **Diagnostic Mode** is enabled. To enable Diagnostic Mode, select **View > Diagnostic Mode**.

Note: The value for the Volume Default Capacity attribute must be set to less than 4 TB.

Note: The advanced file type device ignores the Volume Default Capacity value to allow dynamic expansion of disk space.

- ◆ Save sets from FTDs can be cloned to an AFTD to take advantage of advanced file type device features.
- ◆ The following restrictions apply to FTDs created on a UNIX or Linux network file system (NFS):
 - The file system used for the FTD must not be used for any other data.
 - There must be one FTD per NFS system.
 - The Volume Default Capacity attribute for the FTD must be set to a size that is less than 100 percent of the total capacity of the file system.
- ◆ If the FTD was used prior to setting the Volume Default Capacity attribute, the data for that FTD must be staged or cloned to another device.
- ◆ When a FTD is used as a backup solution, the upper limits of save set size depend on either of these:
 - The upper limits supported by the operating system
 - The file size specified by the disk device vendor

Creating and configuring FTDs and AFTDs

The advanced file type (adv_file) is designed for large disk devices that use a volume manager to dynamically extend available disk space if the disk runs out of space while being accessed as an advanced file type device (AFTD) during backup. The *EMC Software Compatibility Guide* provides a list of supported volume managers. [“Differences between FTDs and AFTDs” on page 244](#) provides

Task 1: Set the AFTD allowed directories attribute

Before creating an AFTD, set the AFTD allowed directories to control access to storage node file systems. If this attribute is populated it limits the AFTD to the device path in the list of allowed directories. If the attribute is left empty, then there will be no restrictions on the path of an AFTD when it is created, with the exception that certain well known system level directories are always rejected.

1. Login to NMC as administrator.
2. In the **Enterprise** tab in NMC, right-click the NetWorker host, and select **New > Managed Application....**
3. Right-click NetWorker in the Managed Application column, and click **Launch Application....**
4. In **Devices**, right click the storage node on which the AFTD will be created.
5. In the storage node **Properties** window, type the directory path in the **AFTD allowed directories:** field.

If there is a conflict due to an existing AFTD, or if the device path does not exist, a notification displays, and the change of allowed directories is rejected.

Task 2: Create and configure an FTD and AFTD device

You can create an a FTD or AFTD by using either the Device Wizard or the device properties window. Choose one of the following methods:

- ◆ [“Create an AFTD by using the Device Wizard” on page 247](#)
- ◆ [“Create an AFTD or FTD by using the Properties window \(UNIX and Linux\)” on page 248](#)
- ◆ [“Create and configure an AFTD or FTD by using the Properties window \(Windows\)” on page 249](#)

Note: Do not modify directories or files created by file type devices or AFTDs. Changes to the device path or its contents prevent the NetWorker software from locating the device.

Create an AFTD by using the Device Wizard

To create an AFTD by using the Device Wizard:

1. In the **Enterprise** tab in NMC, right-click the NetWorker host, and select **New > Managed Application....**
2. Right-click NetWorker in the Managed Application column, and click **Launch Application....**
3. In **Devices**, right click **Devices**, and select **New Device Wizard**.
4. In the **Select the Device Type** window, click to select **AFTD**, and click **Next**.

5. In the **Select Storage Node** window, select a storage node from the list and then click either:
 - **Browse Storage Node Filesystem**, type the **Username** and **Password** in the respective fields, and click **Next**.
 - **Enter device path**, type the device path, and click **Next**.
6. In the **Select the Device Path** window, do either of these:
 - In the required drive, click to select the sub-directory in which to create the AFTD, and click **Next**.
 - Click **New Folder**, type a name for the folder, and click **Next**.
7. In the **Label and Mount device** window, complete these attributes:
 - Label and Mount device after creation... (click to enable this attribute.)
 - Pool Type
 - Backup
 - Backup Clone
 - Pool
Select the appropriate pool from the drop down list.
8. In the **Configure Device Attributes** window, complete the attributes as required, and click **Configure**.
9. Verify the device settings in the **Review the Device Configuration** window. Click **Next** to accept, or click **Back** to change settings if required.
10. Check that the **View results** window lists all the configuration settings for the new device, click **Finish**.

Create an AFTD or FTD by using the Properties window (UNIX and Linux)

To create a FTD or AFTD on UNIX and Linux:

1. Create one directory for each disk (or partition) to be used for an AFTD or file type device. AFTD and file type devices both require a directory to be created in the disk file system that the NetWorker server or storage node recognizes as the device name (and the destination for the data).

Note: Do not use the tmp directory for NetWorker DiskBackup devices because the data could be overwritten.

2. In the server's **Administration** interface, click **Devices**.
3. Right-click **Devices** in the navigation tree, and select **New**.

The **Create Device** window opens, with the **General** tab selected, and a default device name in the **Name** field of the **Identity** area of the window.

4. Replace the default name with the complete path of the directory created. For example:

```
/directory_name
rd=storage node: /directory_name
```

For an NFS-mounted file type device or AFTD, ensure the NFS mount point is available by either automounting or manually mounting it as required:

- a. If the device is configured on the server's storage node (file type or AFTD), the name is the simple device path, such as /backup/d0.

- b. If the device is configured on a remote storage node, then the name must indicate that the storage node is remote, by including **rd=** and the name of the remote storage node in the device path. For example, if the remote storage node is neptune, then the device path might be `rd=neptune:/backup/d0`.
5. In the **Identity** area:
 - a. Add a comment (optional) in the **Comment** field.
 - b. In the **Media Type** field, select a type from the menu:
 - file, for a file type device.
 - `adv_file`, for an AFTD.
6. In the **Status** area, make sure that the **Auto Media Management** feature for AFTD or file type device is not enabled.
7. In the **Cleaning** area, leave the options for cleaning at their default (disabled) settings, so that automatic cleaning is not invoked.
8. Select the **Configuration** tab to set these attributes as required:
 - Target Sessions
 - Max Sessions
 - **Local Backup to a Dedicated Storage Node** (maintain the default No setting)
9. Click **OK** when the configuration is complete.
10. Label and mount the NetWorker DiskBackup Device in the same manner as other offline media used for NetWorker backups.
 - Since the AFTD is never marked full, there is no need to add another device to the pool.
 - Because the AFTD automatically affixes the `.RO` suffix to a volume name, limit the volume name to 60 characters when labeling the volume.

Save set staging is especially useful when using either device type of the NetWorker DiskBackup feature.

Create and configure an AFTD or FTD by using the Properties window (Windows)

To configure an FTD or an AFTD on Windows:

1. Create one directory for each disk (or partition) to be used for AFTD or file type device.

Each disk (or partition) requires a directory that is used for file type device or AFTD storage. Each of these devices requires a directory in the disk file system that the NetWorker server recognizes as the device name (and the destination for the data).

Note: Do not use the temp directory for NetWorker DiskBackup devices. The data could be overwritten. Because AFTDs are never marked as full, there is no need to configure another device in the same pool.

2. In the server's **Administration** interface, click **Devices**.
3. Right-click **Devices** in the navigation tree, and select **New**. The **Create Device** window appears, with the General tab selected, and a default device name in the **Name** field of the **Identity** area of the window.
4. Replace the default name with the complete path of the directory created. For example:

```
H:\device01
rd=mercury:H:\device01
```
5. In the **Identity** area:

- a. Add a comment (optional) in the **Comment** field.
- b. In the **Media Type** field, select a type from the menu:
 - For a file type device, select **File**.
 - For an AFTD, select **Adv_file**.
6. In the **Status** area, make sure that the **Auto Media Management** feature for AFTD or file type device is not enabled.
7. In the **Cleaning** area, leave the options for cleaning at their default (disabled) settings, so that automatic cleaning is not invoked.
8. Select the **Configuration** tab to set these attributes as required:
 - Target Sessions
 - Max Sessions
 - **Local Backup to a Dedicated Storage Node** (maintain the default **No** setting)
9. Click **OK** when the configuration is complete. Label and mount the NetWorker DiskBackup Device in the same manner as other offline media used for NetWorker backups.

AFTD device formats for concurrent operations

Two devices are created when the primary (read-write) advanced file type device is labeled. The NetWorker software creates a secondary device with read-only accessibility. A second volume with the .RO suffix in its name is also created, and is automounted in this device. The read-only device and volume enable concurrent operations, such as reading from the read-only device while writing to the read-write device. Starting in NetWorker 7.6 SP 2, read-only devices are hidden by default. [“Displaying read-only AFTD or Data Domain devices and volumes” on page 251](#) describes how to display read-only devices and volumes.

[Table 37 on page 250](#) lists the device formats created when the AFTD is labeled.

Table 37 AFTD names

Device	AFTD name	Type	Volume
UNIX and Linux format	/mercury/dev1	adv_file	af_1
	/mercury/dev1/_AF_readonly	adv_file	af_1.RO
Windows format	d:\file_devices\dev1	adv_file	af_1
	d:\file_devices\dev_AF_readonly	adv_file	af_1.RO
Common Internet File System (CIFS)	(rd=storage_node:)\<CIFS_host>\sharepoint\dev1	adv_file	af_2
	(rd=storage_node:)\<CIFS_host>\sharepoint\dev1_AF_readonly	adv_file	af_2.RO

Note: The terms `_AF_readonly` name and the `.RO` suffix are reserved for AFTDs. Do not use these terms when naming devices or labeling volumes. Also be aware that because the AFTD automatically affixes the `.RO` suffix to a volume name, limit the volume name to 60 characters.

The following operations can be performed concurrently on a single storage node with an AFTD:

- ◆ Multiple backups and multiple recover operations.
- ◆ Multiple backups and one manual clone operation.
- ◆ Multiple backups and one automatic or manual staging operation.

It might be required to increase the server parallelism value to complete the concurrent operations with an AFTD device when the number of simultaneous save sessions reaches the maximum value for server parallelism.

For example, if server parallelism is set to 4, and there are 4 simultaneous saves going to an AFTD, set the server parallelism to 5 to complete a concurrent clone/stage operation from this AFTD while the four saves are in progress.

Displaying read-only AFTD or Data Domain devices and volumes

Starting with NetWorker 7.6 SP2, read-only devices and read-only volumes are not displayed by default in the NMC console or in reports. For some operations, you may need to display the corresponding read-only device or volume. For example, if you attempt to delete an AFTD or Data Domain device, both the read-write and the corresponding read-only device and volume must be unmounted. If the read-only device or volume is mounted, you must display the read-only device or volume and then unmount it.

To display read-only AFTD or Data Domain devices and volumes:

1. Click **Devices** from the Administration window.
2. Select **View > Display read-only devices and volumes**.

Note: In some cases, you must propagate changes that are made on the read-write device to its corresponding read-only device. Details on propagating changes to the read-only device are available in [“Propagate changes from the read-write Enabled attribute to the read-only Enabled attribute”](#) on page 251.

Propagate changes from the read-write Enabled attribute to the read-only Enabled attribute

When data is backed up, additional entries are added to the NetWorker media index for the data backed up to the device.

When a change is made to the Enabled attribute for the user-created, AFTD read-write device, the same change must immediately be made to the *_AF_readonly* device.

To propagate the changes:

1. Ensure that the read-only device/volume attribute is displayed.
 - a. Click **Devices** from the Administration window.
 - b. Select **View > Display read-only devices and volumes**.
2. Access the read-write device and change the **Enabled** attribute.
3. Access the read-only device and change the **Enabled** attribute to match the change made to the read-write device.

Note: Always make attribute changes first to the read-write device, and then make the changes to the read-only device.

Task 3: Provide sufficient disk space for the AFTD

When an AFTD runs out of disk space, the current backup is interrupted and the following message displays:

```
Waiting for more available space on filesystem device-name
```

Immediately following the message, the action associated with the **Filesystem Full — Recover adv_file Space** notification occurs. By default, the action for this notification uses the **nsrim** command to delete expired save sets. If enough space is cleared, the backup continues. If the recycle setting for the volume is manual, then the expired save sets are not removed from the volume.

The AFTD deletes expired save sets depending on the retention policy and the recycle setting. If sufficient storage space is not available after 10 minutes from when the expired savesets begin deletion, the associated **Filesystem Full—Waiting for adv_file Space** notification action occurs. By default, an email notification is sent to the root user on the NetWorker server on UNIX and Linux, and a message is logged in the media log file in *NetWorker_install_path*\logs on Windows. [“Viewing log files” on page 663](#) provides information about viewing log files.

When the notification is sent, and the message is logged in the media log file, the backup stops until space is available for the backup to continue. You can create customized notifications to change and expand how the NetWorker software behaves when an AFTD Filesystem Full notification occurs. Custom notifications can also invoke custom scripts and other programs to expand the capacity of existing AFTDs. [“Notifications” on page 447](#) and [“Configuring NetWorker SNMP notifications” on page 574](#) provides information on using notifications.

Create a custom notification to extend disk space

While the NetWorker default **Filesystem Full — Recover adv_file Space** notification works by removing its expired save sets, a custom notification could be configured to expand disk or file system space in other ways:

1. In the server’s **Administration** interface, click **Configuration**.
2. Right-click **Notifications** and select **New**.
3. For **Name**, type a unique name for this custom notification, such as First adv_full notice.
4. For **Event**, clear all choices *except* adv_file.
5. For **Priority**, clear all choices *except* Waiting.
6. For **Action**, specify the full path of the custom script configured to expand diskspace, for example: /mybin/my_first_custom_script.
7. Click **OK**.

Create a custom notification for insufficient disk space

The NetWorker default **Filesystem Full — Waiting for adv_file Space** notification works by sending an email notification, a custom notification could be configured to do whatever the user indicates. The wait time after the default notification is approximately 10 minutes.

1. In the server’s **Administration** interface, click **Configuration**.
2. Right-click **Notifications** and select **New**.
3. For **Name**, type a unique name for this second custom notification, such as Second adv_full Notice.

4. For **Event**, clear all choices *except* `adv_file`.
5. For **Priority**, clear all choices except **Critical**, **Emergency**, and **Alert**.
6. For **Action**, specify the full path of the custom script to be invoked, for example: `/mybin/my_second_custom_script`.
7. Click **OK**.

AFTD device target and max sessions

The defaults for AFTD target sessions and max device sessions are now set to the optimal values for AFTD performance:

- ◆ Device target sessions is 1
- ◆ Device max sessions is 32 to avoid disk thrashing

If required, both device target, and max session attributes can be modified to reflect values appropriate for the environment. [Table 38 on page 261](#) provides default target and max session values and recommendations for other device types.

AFTD load balancing

You can adjust the target and max sessions attributes per device to balance the data load for simultaneous sessions more evenly across available devices. These parameters specify the maximum number of save sessions to be established before the NetWorker server attempts to assign save sessions to another device.

For AFTDs, all volumes, depending on the selection criteria (pool settings), choose the AFTD with the least amount of data written to it, and join sessions based on the device's target and max sessions. If the number of sessions being written to the first device exceeds the target sessions setting, another AFTD is considered for new backup sessions and is selected from the remaining suitable AFTDs. The AFTD that is selected will be the AFTD with the least amount of NetWorker data written to it. The least amount of data written is calculated in bytes (not by percentage of disk space used) and only bytes that were written by NetWorker are counted.

To ensure that a new session always writes to the AFTD with the least amount of data written to it, you can set each AFTD device's **max sessions** attribute to **1**. However, setting the max sessions attribute to 1 may not be practical. Alternatively, set the **target sessions** attribute to **1**. In this way, load balancing will occur on a best efforts basis.

Space management for AFTD

A configurable setting for determining at what capacity the NetWorker software should stop writing to an AFTD spans from 1 to 100%. Setting the value to 0 or leaving the attribute empty in the AFTD Percentage Capacity attribute is equivalent to a setting of 100%. This means that the entire capacity of the filesystem can be used for the AFTD volume.

When set, the AFTD Percentage Capacity attribute is used to declare the volume full and to calculate high/low watermarks. When the percentage capacity attribute is modified, mount and re-mount the volume for the new settings to take effect.

The level watermark is calculated based on the percentage of restricted capacity, not on the full capacity of the filesystem.

In the Console **Administration** interface, the AFTD Percentage Capacity displays in the **Configuration** tab of the **Properties** window of a device when **Diagnostic Mode** is enabled. To enable Diagnostic Mode, select **View > Diagnostic Mode**.

Task 4: (Optional) Share an AFTD between storage nodes in a NAS or SAN environment

In a Network Attached Storage (NAS) environment, NetWorker operations can be performed concurrently on two storage nodes that share an AFTD. When sharing an AFTD, one storage node can save to a writable volume, while the other storage node either recovers or clones from a read-only volume.

In a Storage Area Network (SAN), NetWorker operations are performed sequentially when two storage nodes share an AFTD. Only one storage node at a time can use the shared AFTD.

Any staging occurs from the storage node that has the read-only volume mounted.

Certain configuration changes must be made to share an AFTD between storage nodes. [“Task 4: \(Optional\) Share an AFTD between storage nodes in a NAS or SAN environment” on page 254](#) provides more information.

When the configuration completes, however, no change is required in how to start these operations:

- ◆ Backup
- ◆ Recovery
- ◆ Cloning
- ◆ Staging

Shared AFTD considerations

Review these considerations before sharing AFTDs:

- ◆ Ensure that operating system permissions (directory and file) and sharing are set up properly between storage node hosts for the root user or Windows administrator, to enable proper sharing of AFTDs on the file system.

Use operating system commands to create, copy, or erase directories or files on the sharing disk (such as NAS, JBOD in SAN), to ensure that sharing is possible at file system level between machines. If the operating system does not permit such sharing, then the NetWorker software cannot change that.

- ◆ Consider the [“Shared AFTD limitations” on page 255](#) before creating shared AFTDs.
- ◆ To share an AFTD between storage nodes, ensure to:
 - Set the proper Storage Node and Clone Storage Node attributes in the Client resource.
 - Specify for the Staging resource, the proper Device attribute (the one with the read-only volume mounted).
- ◆ To share an AFTD in NAS on Windows storage nodes, ensure to:
 - Start the `nsrexecd` (NetWorker Remote Exec) service is started by a Windows Administrator account on the storage node.
 - Create the CIFS-mapped AFTD with UNC pathnames that have the appropriate remote user and password specified. An example of UNC path syntax is:

```
rd=sn_a:\\nas1\path\shared_aftd
```

[“Create CIFS-mounted AFTD on Windows servers and storage nodes” on page 258](#) provides more information.

Shared AFTD limitations

Shared AFTDs include these limitations:

- ◆ Read-only volumes might be automounted onto the writing storage node during saves. The workaround is to unmount all sharing instances of read-only and read-write AFTD volumes from all storage nodes, and then correctly remount them.
- ◆ Limitations on sharing AFTD between storage nodes in NAS/SAN:
 - Supports only homogeneous storage node platforms when sharing AFTD (such as Windows with Windows storage nodes, or UNIX with UNIX storage nodes).
 - The sharing read-write or read-only AFTD volume must be manually unmounted from one storage node before being mounted on another, in order to prevent a potential out-of-sync state for the volume.
 - All instances of the sharing read-write or read-only AFTD volume must be manually unmounted from all of the sharing storage nodes before relabeling the sharing AFTD, in order to prevent potential data loss.
 - For SAN only:

One storage node at a time can perform NetWorker operations.

Use operating system or SAN commands to mount or enable the sharing disk on the second storage node after unmounting or disabling from the first storage node. This ensures that file and directory sharing of the same disk is supported (set up) in the SAN from the sharing storage nodes, allowing the sequential sharing of the disk as an AFTD in the NetWorker software.

Configure a shared AFTD in a NAS environment

When sharing an AFTD between two storage nodes in a NAS environment, these conditions apply:

- ◆ For UNIX or Linux, NFS mount the NAS file system for AFTD on the sharing storage nodes.
- ◆ For Windows, CIFS mapping to the NAS file system is optional on the storage nodes.

Perform these steps to configure a shared AFTD in a NAS environment:

1. To create and label the AFTD on storage node A (*sn_a*):
 - On UNIX or Linux: `rd=sn_a:/shared_aftd`
 - On Windows: `rd=sn_a:\\nas1\path\shared_aftd`

The remote user and password must be specified if this requirement is set up in the NAS file system.
2. To create the same AFTD on storage node B (*sn_b*):
 - On UNIX or Linux: `rd=sn_b:/shared_aftd`
 - On Windows: `rd=sn_b:\\nas1\path\shared_aftd`
3. In the NetWorker software, mount the AFTD, but do not label it on storage node B, to create the read-only volume.
4. In the NetWorker software, unmount all volumes of the shared AFTD on storage nodes A and B.

5. To write (back up) to storage node A in the NetWorker software:
 - a. In the NetWorker software, unmount the read-write volume from storage node B (if it is mounted).
 - b. Mount the read-write volume on storage node A.
 - c. Configure the **Storage Nodes** attribute of the Client resource (*sn_a*).
 - d. Ensure that the NetWorker server's local storage node has a volume available for a bootstrap backup.
6. To read (recover, clone, or stage) from storage node B:
 - a. In the NetWorker software, unmount the read-only volume from storage node A if it is mounted.
 - b. Mount the read-only volume on storage node B.
 - c. Configure the Recover **Storage Nodes** attribute of the **Client** resource (*sn_b*).
 - d. Configure the **Clone Storage Nodes** attribute in the **Client** resource with the target of the clone (or stage) operation.
 - e. Configure the staging policy's **Devices** attribute to select `rd=sn_b:/shared_aftd` for autostaging from *sn_b*.

Configure a shared AFTD in a SAN environment

When sharing an AFTD between two storage nodes in a SAN environment, use the appropriate operating system command or SAN command to unmount (disable) the sharing disk from any machine, and mount (enable) the same disk on storage node A.

Perform the following steps to configure a shared AFTD in a SAN environment:

1. Create, label, and mount the sharing AFTD on storage node A.
2. Perform the **save**, **recover**, or **clone to** operation from storage node A (with the **Storage Nodes** attribute of the Client resource configured as storage node A).
3. Perform the **stage** operation from storage node A. Choose the shared AFTD from storage node A in the **Device** attribute of the Stage resource.
4. In the NetWorker software, unmount the AFTD volumes from the sharing storage node A.
5. Use the appropriate operating system command or SAN command to unmount (disable) the sharing disk from storage node A, and mount (enable) the same disk on storage node B.
6. Create the AFTD to share in a SAN for storage node B.

7. In the NetWorker software, mount the AFTD (but do not label it) on storage node B.
8. Perform the **save**, **recover**, or **clone to** operations from storage node B (with the **Storage Nodes** attribute of the Client resource configured as storage node B).
9. Perform the **stage** operation from storage node B. Choose the shared AFTD from storage node B in the **Device** attribute of the Stage resource.

Task 5: Verify FTD and AFTD operations

The FTD and AFTD can be deployed in varying environments with local disks, and with NFS-mounted or CIFS-mapped disks. The configuration of this feature affects its operation. Ensure that the AFTD is fully operational in the production environment before deploying it as part of regularly scheduled operations.

Note: Dynamic Drive Sharing is not supported with the AFTD.

As part of the validation process, test these operations:

- ◆ Backup
- ◆ Recover
- ◆ Staging
- ◆ Cloning
- ◆ Maximum file size compatibility between the operating system and a disk device
- ◆ Use of a volume manager to increase the file system size while the file system is in use
- ◆ File system behavior when the disk is full

Note: Some versions of Network File System (NFS) or Common Internet File System (CIFS) drop data when a file system becomes full. Be sure to use versions of NFS, CIFS, and operating systems that fully support full file systems.

On some disk devices, the volume labeling process can take longer than expected. This extended labeling time depends on the type of disk device used and does not indicate a limitation of the NetWorker software.

The upper limits of save set size depend on either the upper limits supported by the operating system or the file size specified by the disk device's vendor.

Do *not* edit device files and directories, it is not supported, and can cause unpredictable behavior and make it impossible to recover data.

Create CIFS-mounted AFTD on Windows servers and storage nodes

This section explains how to start the NetWorker service and configure the AFTD on a CIFS connection on a Microsoft Windows system. The NetWorker service must be started by a member of the Administrator group before the AFTD can be configured.

Start the NetWorker service on Microsoft Windows

To start the NetWorker services as a user with administrator rights:

1. Create an Administrators account. For example: NWservice.
2. Ensure that the user account created for the NetWorker **Remote Exec** service has Full control on the share where the AFTD is used.
3. Ensure that **User must change password at next logon** is cleared.
4. Ensure that **User cannot change password** is selected.
5. Ensure that **Password never expires** is selected.
6. Do not set the **Administrator** account to an account that has **login as a service** rights.
7. From the Windows Start menu, select **Settings > Control Panel > Administrative Tools > Services**.
8. Right-click **Services**.
9. Stop the appropriate service:
 - For a NetWorker server, stop the NetWorker **Backup and Recover** service and NetWorker **Remote Exec** service.
 - For a NetWorker storage node, stop the NetWorker **Remote Exec** service.
10. Right-click the NetWorker **Remote Exec** service that was stopped in step 9 and select **Properties**.
11. Select the **Log On** tab.
12. Select **This Account**.
13. Replace **Local System** with the Administrative user created (NWservice).
14. Type the administrator password in the appropriate field.
15. Click **OK**.

When a service is given a user account, it is automatically given login as a service rights. When the NetWorker Backup and Recover service is started, it will automatically start the NetWorker Remote Exec service.

Configure a CIFS-mapped AFTD on a Windows server and storage node

To configure a CIFS-mapped AFTD:

1. Create one directory for each disk (or partition) to be used for AFTD. AFTD and file type devices both require the creation of a directory in the disk file system that the NetWorker server recognizes as the device name and the destination for the data.
2. In the server's **Administration** interface, click **Devices**.

3. Right-click **Devices** in the navigation tree, and select **New**. The **Create Device** window appears, with the **General** tab selected, and a default device name in the **Name** field of the **Identity** area of the window.
4. Replace the default name with the complete path of the directory created by using the Universal Naming Convention (UNC):
 - `\\CIFS_host\share-point-name\path`
 - `rd=sn_host:\\CIFS_host\share-point-name\path`

Note: To configure a Microsoft Windows server, do not include `rd=<sn_host>` in the UNC.
5. For **Media Type**, select `adv_file`.
6. In the **Status** area, make sure that the **Auto Media Management** feature for AFTD or file type device is not enabled.
7. In the **Cleaning** area, leave the options for cleaning at their default (disabled) settings, so that automatic cleaning is not invoked.
8. Select the **Configuration** tab to set these attributes as required:
 - Target sessions
 - Max sessions
 - **Local Backup to a Dedicated Storage Node** (maintain the default No setting)
9. In the **Remote Host** area:
 - Leave NDMP unselected.
 - These are required if the CIFS file system is set up to require password access:
 - a. Type the CIFS file system username in the **Remote User** field. For example, in the configuration illustrated in [Figure 28 on page 259](#), type the administrator of the CIFS file system.
 - b. Type the CIFS password in the **Password** field. For example, in the configuration illustrated in [Figure 28 on page 259](#), type the password for the CIFS file system.
10. Click **OK**, when the configuration completes.

Note: If a new password for the CIFS AFTD is provided, the NetWorker services must be restarted on both the server and storage node in order for the new password to take effect, and to reestablish the CIFS connection correctly.

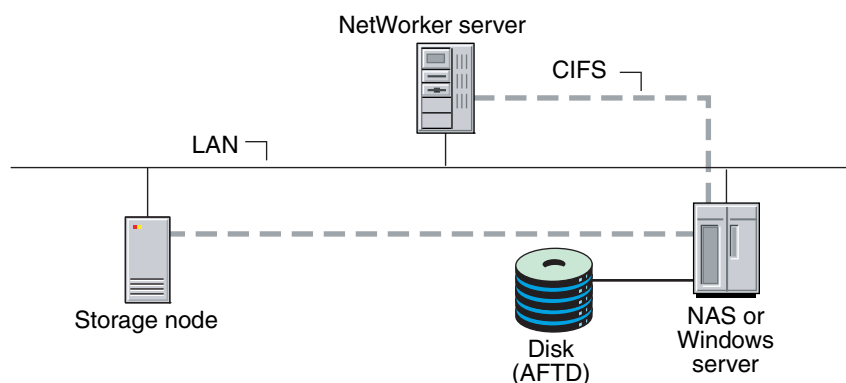

Figure 28 CIFS-mounted advanced file type device

Recover save sets by using AFTD concurrent operations

When recovering from an AFTD, save sets are recovered concurrently. Multiple save sets can be simultaneously recovered to multiple clients.

AFTD save sets can be cloned to two different volumes simultaneously. [“Differences in the cloning process” on page 245](#) provides more information.

[Figure 29 on page 260](#) shows a system configuration where both NetWorker client A and NetWorker client B can use NFS to recover files concurrently from AFTD1.

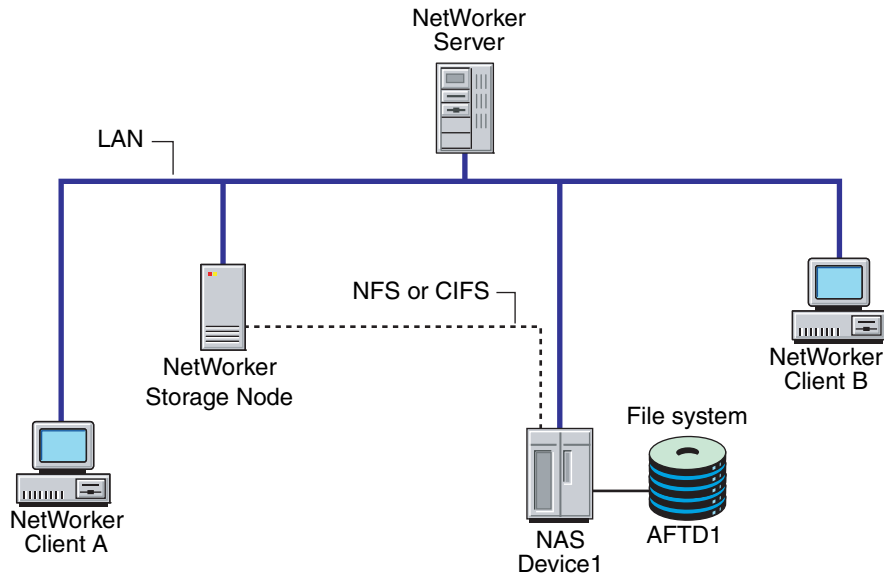

Figure 29 AFTD Configuration

Limitations with concurrent AFTD recovery operations

AFTD concurrent recovery currently has these limitations:

- ◆ Not available to the Windows recover interface (winworkr). Use the **recover** command. The *NetWorker Command Reference Guide* or the **recover** man page provides more information.
- ◆ Not available to nonfile recoveries, such as NDMP and NetWorker database modules.
- ◆ NetWorker release 7.2x clients on Windows recover data from AFTD storage nodes sequentially.

Concurrent recoveries must be performed from the command line by using the **recover** command, either by using multiple **-S** options to identify multiple save sets, or executing multiple **recover** commands concurrently.

Delete FTD and AFTD

“[Devices and libraries](#)” on page 98 provides information about deleting file type and advanced file type devices.

License NetWorker DiskBackup solutions

The NetWorker *Licensing Guide* provides information on licensing for the NetWorker DiskBackup option.

Device target and max sessions default values and ranges

[Table 38 on page 261](#) lists the default values and ranges for device target and max sessions in the NetWorker Administration interface.

Table 38 Default values and ranges for Target and max sessions attributes.

Device type	Default target sessions	Default max sessions	Recommended sessions*	Range
AFTD (traditional storage)	1	32	1 - 32	1 - 512
AFTD (Data Domain CIFS/NFS)	1	32	1 - 10	1 - 512
Data Domain (Boost)	1	10	1 - 10	1 - 60
Cloud	1	512	Any	1 - 512
NDMP	4	512	1 - 32	1 - 512
FTD	4	512	1 - 16	1 - 512
VTL/Tape (Traditional)	4	512	1 - 16	1 - 512
VTL/Tape (Data Domain / Deduplicated)	4	512	1 - 1	1 - 512

* The recommended session values are guidelines only and are subject to bandwidth, data type, and device capabilities.

Compatible block size for UNIX and Windows

Different SCSI hardware limitations exist between UNIX and Microsoft Windows operating systems. This can lead to compatibility problems (although they are less likely to occur now than in the past, given larger Fibre-Channel capacities). For example, with a device defined in UNIX that is physically attached to a Windows HBA, it is possible to define a block size greater than that allowed by the Windows hardware. This could lead to I/O errors in both write and read states on the device. In order to use both operating systems, it is necessary to determine a block size that is acceptable to both.

Determine the allowable block size

To determine the allowable block size, check the **Properties** window of a mounted volume while in **Diagnostic Mode**:

1. In the server’s **NetWorker Administration interface**, click **Devices**.

2. Select **View > Diagnostic Mode**.
3. Open the **Libraries** folder in the navigation tree and select the drive that contains the mounted volume with the block size being checked. The drive's detail table appears.
4. Right-click the drive in the detail table, and select **Properties**. The **Properties** window appears.
5. Select the **Volume** tab. In the **Loaded Volume** area, one of the displayed volume attributes is the **Volume Block Size**.
6. Click **OK**.

Set the block size for a device type

To set the block size for an entire device type:

- ◆ On UNIX, change the block size by setting this environment variable to the greatest common value for both systems. For example:

```
setenv NSR_DEV_BLOCK_SIZE MEDIA_TYPE value
```

where:

- *MEDIA_TYPE* is the backup device type available to the NetWorker server (also found in the Media Type attribute on the General tab of the device's properties). The media type syntax must be all uppercase, with underscores (_) replacing blank spaces and hyphens. Therefore, a device displayed in the NetWorker software as "8mm Mammoth-2" would be listed as:

```
8MM_MAMMOTH_2
```
- *value* must be a multiple of 32 KB, with a minimum value of 32 KB.
- ◆ On Microsoft Windows only, install a later model HBA, or upgrade to drivers that can support up to 128 KB blocks. Windows also accepts the same environment variable format as UNIX to set block size.

Restart the NetWorker server in order for changed environment variables to take effect.

Device block size for read and write operations

The blocksize for a volume is defined during the label operation.

The block size for both read and write operations uses the block size defined in the volume header during the label operation rather than the device block size.

Library device maintenance

This section describes how to maintain storage devices.

Periodic maintenance

Clean a storage device periodically to keep it working correctly. The NetWorker server provides automatic cleaning of drives located in libraries. The server does not support automatic cleaning for stand-alone devices. Cleaning is an option set during configuration.

The service mode feature allows a library to be taken offline temporarily for cleaning or other maintenance.

Automatic tape device cleaning

Tape device cleaning is an automated, self-contained operation. It is no longer part of a media-loading operation. Tape device cleaning is automatically triggered if one of these conditions exist:

- ◆ The last time the device was cleaned was a full cleaning interval ago.
- ◆ The Cleaning Required attribute for the device is set to Yes in one of the following ways:
 - Manually by the user.
 - Automatically by the NetWorker server, after it receives a "device needs cleaning" notification.

When one of these conditions is met for a device, cleaning begins as soon as the device becomes available. Loaded devices are unloaded before a cleaning operation begins. Loading a cleaning cartridge (with the `nsrjb -l cleaning cartridge` command) to force a cleaning operation is no longer supported.

How to manually select a tape device for cleaning

To set the cleaning attributes of a library:

1. In the server's **NetWorker Administration** interface, click **Devices**.
2. Open the **Libraries** folder in the navigation tree and select the drive that contains the mounted volume with the block size being checked. The drive's detail table appears.
3. Right-click the drive in the detail table, and select **Properties**. The **Properties** window appears.
4. Select the **General** tab.
5. Set the **Cleaning Required** attribute to **Yes**.

Note: Do not enable automated cleaning for silos in the NetWorker software. The automated device cleaning feature cannot be used in a silo, because it depends on fixed slot numbers. For information about how to clean devices in a silo, refer to the silo manufacturer's software documentation.

How to delay tape device cleaning

It is sometimes necessary to delay the cleaning of a tape device which is scheduled for cleaning.

To set the value for cleaning delay:

1. In the server's **NetWorker Administration** interface, click **Devices**.
2. Select **View > Diagnostic Mode**.
3. Open the **Libraries** folder in the navigation tree.
4. Right-click the appropriate library in the detail table, and select **Properties**. The **Properties** window appears.
5. Select the **Timers** tab.
6. Select a value in seconds for the **Cleaning Delay** attribute.

Tape alert

The TapeAlert feature provides, among other things, diagnostic information for devices for which hardware cleaning is enabled. To use this feature, select **enabled** for the **Cleaning** attribute of the **Device** resource so that automatic cleaning is enabled.

When the Common Device Interface (CDI) is enabled, TapeAlert attributes provide tape drive status. SCSI Commands must be selected for the CDI attribute on the Configuration tab of the relevant device's Properties. If CDI cannot be enabled, TapeAlert is not supported. "[Common device interface](#)" on page 268 provides more information about CDI.

Devices that are capable of TapeAlert perform constant self-diagnostics and communicate the diagnostic information via the **nsrmmmd** program to logs that can be viewed in the Monitoring task.

TapeAlert attributes are found in the device's Properties, on the Volume tab. Their respective descriptions are as follows:

- ◆ TapeAlert Critical: Displays critical diagnostic information, such as for media or drive failure, when user intervention is urgent and data is at risk.
- ◆ TapeAlert Warning: Displays a message when the media or device needs servicing.
- ◆ TapeAlert Information: Displays status information.

[Table 39](#) describes the nature of the tape alert levels.

Table 39 Tape alert severity

Severity	Urgently requires user intervention	Risks data loss	Explanatory
Critical	X	X	
Warning		X	X
Informative			X

The messages indicate tape and drive states related to tape drive read/write management, cleaning management, or drive hardware errors.

Informative messages

Informative messages indicate status information:

- ◆ A data or cleaning tape is nearing its end of life.
- ◆ A tape format that is not supported.

Note: When automatic cleaning is enabled, a diagnostic message to indicate that a drive needs cleaning initiates NetWorker drive cleaning.

Warning messages

Warning messages indicate the following types of drive errors:

- ◆ Recoverable read or write errors occurred.
- ◆ Media is at end of life.
- ◆ Read-only tape format is in the drive.
- ◆ Periodic cleaning is required.

Critical messages

Critical messages are warnings that a drive might be disabled and requires immediate attention to avoid data loss:

- ◆ Unrecoverable read or write errors occurred.
- ◆ Tape is marked read-only.
- ◆ Drive require immediate cleaning.
- ◆ Drive is predicting hardware failure.

Informative and warning messages should clear automatically by **nsrmmmd** once the reported issue is handled.

Critical messages about hardware errors are not cleared by **nsrmmmd** because they might indicate intermittent hardware problems.

Service mode

Use the service mode setting to take a device offline temporarily. Service mode differs from the disabled state in that the **nsrmmmd** process is not stopped.

While a device is in service mode, **save** or **recover** sessions that are either in process or pending are completed. No new sessions are assigned to the device while it is in service mode.

Although a drive in service mode is taken out of the collection of drives that the NetWorker software can select for automated operations, the drive is available for some manual operations that use the **nsrjb** or **nsrmm** command with the **-f** option. For more information, refer to the *EMC NetWorker Command Reference Guide* or the UNIX man pages.

The device might also go into service mode, rather than become disabled, if consecutive errors occur in excess of the maximum consecutive error count specified for the device. This means that if there are no hardware issues, the tape can be ejected and used in other drives. [“Media handling errors” on page 304](#) provides more information about how to set the maximum consecutive error count.

Note: The drive must be manually reset to Enabled for the NetWorker software to use the device again.

To put a device in service mode:

1. Open the device’s **Properties** window
2. On the **General** tab, set **Status Enabled to Service**.

Device parameter settings

In NetWorker release 7.3 and later, device parameters can be set in the NetWorker Administration interface for individual devices on a server. In earlier releases, environment variables were used to set device parameters for all devices on a given NetWorker server.

Environment variables can still be used to adjust several NetWorker device parameters, but the adjustment of environment variables should only be done by users who know the server environment and performance tuning (for example, an administrator who wants to fine-tune performance by changing a certain setting for all LTO devices on a particular NetWorker server).

The variables (and their equivalent names in the Administration interface) are described in these sections:

- ◆ “Device settings in the NetWorker Administration interface” on page 266
- ◆ “Device settings as environment variables” on page 266

Device settings in the NetWorker Administration interface

To locate and change the device parameters in the Administration interface:

1. In the server’s **Administration interface**, click **Devices**.
2. Select **View > Diagnostic Mode**.
3. Select **Devices** in the navigation tree. The Devices detail table appears.
4. Double-click the device in the devices table or right-click the device and select **Properties**. The **Properties** window appears, with the **General** tab selected.
5. Select the **Advanced** tab. In the **Device Configuration** area, the device settings are the first fields shown. The following table lists the fields and their corresponding environment variables:

Table 40 Device settings and environment variables

Device setting	Corresponding environment variable
Device Block Size	NSR_DEV_BLOCK_SIZE_MEDIA_TYPE
Device File Size	NSR_DEV_TAPE_FILE_SIZE_MEDIA_TYPE
Device Load Time	NSR_DEV_LOAD_TIME_MEDIA_TYPE
Device Eject Time	None
Device Poll Interval	NSR_DEV_LOAD_POLL_INTERVAL_MEDIA_TYPE
Device Min Load Tries	NSR_DEV_LOAD_TRY_LIMIT_MEDIA_TYPE
Device Default Capacity	NSR_DEV_DEFAULT_CAPACITY_MEDIA_TYPE
Device Tape Flags	None

When device parameters are set in this interface, it is not necessary to stop and restart the NetWorker server in order for the settings to take effect.

Device settings as environment variables

The device-related environment variables are:

- ◆ **NSR_DEV_BLOCK_SIZE_MEDIA_TYPE**
- ◆ **NSR_DEV_TAPE_FILE_SIZE_MEDIA_TYPE**
- ◆ **NSR_DEV_LOAD_TIME_MEDIA_TYPE**
- ◆ **NSR_DEV_LOAD_POLL_INTERVAL_MEDIA_TYPE**
- ◆ **NSR_DEV_LOAD_TRY_LIMIT_MEDIA_TYPE**
- ◆ **NSR_DEV_DEFAULT_CAPACITY_MEDIA_TYPE**

where:

MEDIA_TYPE is the backup device type available to the NetWorker server.

Note: The media type syntax must be all uppercase, with underscores (_) replacing blank spaces and hyphens. For example, a device displayed in the NetWorker software as "8mm Mammoth-2" would be listed as: 8MM_MAMMOTH_2

To determine the media type, right-click the device and select the **General** tab. The **Media Type** attribute contains the media type that should be used in these environment variables.

Microsoft Windows users use the Control Panel's System applet to set these system environment variables. The NetWorker Backup and Recover Server service must be restarted in order for the environment variables to take effect.

UNIX/Linux users set these environment variables in the NetWorker startup script before this line:

```
echo 'starting NetWorker daemons:') > /dev/console
```

Type the variables in this format:

```
ENV_VAR_NAME = value
```

```
export ENV_VAR_NAME
```

The NetWorker server must be restarted in order for the environment variables to take effect.

[Table 41](#) lists the location of NetWorker startup scripts on UNIX and Linux systems.

Table 41 NetWorker startup script location on UNIX/Linux systems

Operating system	Startup script location
Solaris, Linux, and IRIX	/etc/init.d/networker
HP-UX, HP Tru64	/sbin/init.d/networker
AIX	/etc/rc.nsr

NSR_DEV_BLOCK_SIZE_MEDIA_TYPE

NSR_DEV_BLOCK_SIZE_MEDIA_TYPE is organized in units of kilobytes. This environment variable will cause NetWorker to override the default block-size setting defined for the tape drive in the operating system. The value set must be a multiple of 32, with a minimum value of 32. Maximums are determined by platform, SCSI driver, and device. For example:

```
NSR_DEV_BLOCK_SIZE_4MM_20GB=64
```

For information about using this environment variable to set block-size compatibility between UNIX and Microsoft Windows. "[Compatible block size for UNIX and Windows](#)" on page 261 provides more information.

NSR_DEV_TAPE_FILE_SIZE_MEDIA_TYPE

NSR_DEV_TAPE_FILE_SIZE_MEDIA_TYPE is organized in units of **NSR_DEV_BLOCK_SIZE_MEDIA_TYPE** and is the number of blocks written between filemarks. These filemarks are used to locate a particular spot on the tape during recovery, and more filemarks generally lead to faster positioning. For example:

```
NSR_DEV_TAPE_FILE_SIZE_TZ89=512
```

On UNIX and Linux platforms, the NetWorker software writes a filemark by closing and reopening the tape device, which takes one or two seconds. If this value is too small, throughput could be slowed and recoveries may take longer to complete.

On Microsoft Windows platforms, the NetWorker software writes asynchronous filemarks. This setting has a minimal effect on performance.

NSR_DEV_LOAD_TIME_MEDIA_TYPE

`NSR_DEV_LOAD_TIME_MEDIA_TYPE` is the number of seconds that `nsrmmmd` polls and waits for a drive to become ready after the library inserts a tape into the device. `NSR_DEV_LOAD_POLL_INTERVAL_MEDIA_TYPE` is used to set the number of seconds `nsrmmmd` waits between polls during load time.

If the value of `NSR_DEV_LOAD_TIME_MEDIA_TYPE` is too short, there could be unnecessary load failures. If it is too long, then labeling new tapes takes longer than necessary. The minimum allowable value is 10 seconds. The maximum value is 600 seconds. For example:

```
NSR_DEV_LOAD_TIME_DTL8000=300
```

NSR_DEV_LOAD_POLL_INTERVAL_MEDIA_TYPE

`NSR_DEV_LOAD_POLL_INTERVAL_MEDIA_TYPE` is the number of seconds that `nsrmmmd` waits between each attempt to read a newly inserted tape. The minimum allowable value is 1 second, the maximum value is 30 seconds. For example:

```
NSR_DEV_LOAD_POLL_INTERVAL_DLT=10
```

NSR_DEV_LOAD_TRY_LIMIT_MEDIA_TYPE

`NSR_DEV_LOAD_TRY_LIMIT_MEDIA_TYPE` is the number of times that `nsrmmmd` will attempt to open a drive. The `nsrmmmd` program will poll the drive until the limit set in `NSR_DEV_LOAD_TIME_MEDIA_TYPE` is reached. After the limit is reached, it will retry until the `NSR_DEV_LOAD_TRY_LIMIT_MEDIA_TYPE` is reached. The default value and minimum allowable value is 2, the maximum value is 120.

```
NSR_DEV_LOAD_TRY_LIMIT_DLT=4
```

NSR_DEV_DEFAULT_CAPACITY_MEDIA_TYPE

`NSR_DEV_DEFAULT_CAPACITY_MEDIA_TYPE` is the size of the particular tape used to base the percent full calculation. This variable value has no effect on the actual tape capacity. Any integer value is allowed, with a KB, MB or GB designation to indicate a range of values. Any value less than 200 MB will be overridden by the normal default capacity. There is no obvious maximum, with the only practical limitation being the actual storage size. For example:

```
NSR_DEV_DEFAULT_CAPACITY_DTL7000=12GB
```

Common device interface

The common device interface (CDI) allows the NetWorker server to send commands to tape devices.

CDI support can be set in the NetWorker Administration interface:

1. In the server's **NetWorker Administration interface**, click **Devices**.
2. Select **View > Diagnostic Mode**.
3. Select **Devices** in the navigation tree. The Devices detail table appears.
4. Double-click a device in the **Devices** table (or right-click the device and select **Properties**). The **Properties** window appears, with the **General** tab selected.
5. Select the **Advanced** tab. In the **Device Configuration** area, locate the CDI settings:

- **Not Used:** Disables the CDI feature and uses standard tape driver calls for tape operations.
- **SCSI Commands:** Sends explicit SCSI commands to tape devices.

When enabled, the CDI feature:

- Provides clearer tape status messages.
- Informs when a tape is write protected.
- Enables Tape Alert, which provides diagnostic information for devices.

Although the CDI feature can be disabled through selecting the Not Used option, it can be time-consuming to disable a large number of devices.

In this situation, access the `/nsr/debug` directory and create a file named `cdidisable`. Then restart the NetWorker server. This file does not need any content, it just needs to exist. This disables the use of CDI for that server and all storage nodes controlled by that server.

The CDI feature is not supported in these cases:

- ◆ Within an NDMP environment.
- ◆ On an SGI IRIX server or storage node.

The CDI feature is not supported for tape devices connected directly on SGI systems. It can, however, be used by CDI-supported storage nodes (for example, Solaris) controlled by a NetWorker server that is running on SGI.

Note: Use of CDI does not change what is written to tape. A tape written with CDI enabled can be read with CDI disabled. Conversely, a tape written with CDI disabled can be read with CDI enabled. The CDI feature enables NetWorker software to collect better diagnostic information and facilitates tape usage when enabled. Only set or disable the CDI feature on the advice of an EMC Customer Support representative. If tape or SCSI issues occur while the CDI feature is enabled, go to the EMC Powerlink website.

Device ordering

The NetWorker server uses logical device names assigned by the operating system when communicating with devices. It is possible for the operating system to re-associate logical device names with the physical addresses of the devices, generally after rebooting the host or after plug-and-play events. This may cause device reordering, where the physical device will have a different device filename. As a result, tape devices configured in the NetWorker software no longer match the names of the devices as recognized by the operating system.

If device reordering occurs, the NetWorker software is unable to use any affected drives until the configuration is manually corrected.

The NetWorker server detects device reordering events by comparing the current serial number of the device to the serial number of the device at configuration. If the serial numbers do not match, the NetWorker server stops all operations on that device and an error message will be posted, similar to the alert identified for device serial number mismatch in the table [“Preconfigured notifications” on page 447](#). CDI must be enabled for this functionality. [“Common device interface” on page 268](#) provides more information about enabling CDI.

Persistent binding and naming

Some operating systems provide the persistent binding option to permanently bind logical and physical addressing so that the associations are retained. This guarantees that the operating system always uses and creates the same symbolic path for a device is known as persistent naming.

Proper configuration of the operating system to use persistent binding and persistent naming resolves issues related to device ordering by forcing the operating system to always assign the same device filename regardless of external events.

Persistent binding

Persistent binding guarantees that the operating system always uses the same SCSI target ID for SAN devices, regardless of reboots or other events, by statically mapping a target's WWN address to a desired SCSI address. On some operating systems, this is done by default, while on others it has to be set manually. The operating system documentation provides further information.

In most cases, persistent binding should also be set on the Host Bus Adapter (HBA) by using the configuration utility that comes with the Fibre Channel HBA. The HBA device driver documentation provides details.

Persistent binding is required for consistent library operations within NetWorker, because the NetWorker server communicates with the library controller over a SCSI address that is chosen during initial library configuration. If the SCSI address changes, the library will become unavailable. In this case, disable the library and change the "control port" address to reflect the new SCSI address of the library controller.

If devices have already been configured in NetWorker prior to enabling persistent binding on the host, delete existing devices from the library resource and perform a re-scan of devices followed by a reconfiguration of the tape library.

Persistent naming

Persistent naming is used to ensure that the operating system or device driver of a server always creates and uses the same symbolic path for a device (referred to as device file).

Once persistently named device files are created and present on the host, enable the use persistent names option when scanning for tape devices from the NetWorker Management Console.

If devices have already been configured in NetWorker prior to enabling persistent naming on the host, delete existing devices from the library resource and perform a re-scan of devices followed by a reconfiguration of the tape library.

Detecting device ordering issues

To determine if there is a problem with device ordering in your environment, you first determine if the device order that appears in `nsrjb` output matches the device order from the `inquire` and `sjisn` commands, then verify that the device configuration within your NetWorker configuration conforms to this.

To detect device ordering issues:

1. Execute the `inquire` command with the `-cl` option to determine the device path, scsi address, and serial number of the device.
2. Execute the `sjisn` command to determine the current order of the devices:

```
sjisn scsidev@bus.target.lun
```

where *bus.target.lun* is the SCSI address of the robotic arm returned by the inquire command in step 1, for example, 1.2.0.

3. Match the serial numbers of the devices in the sjisn output to the device names that correspond to these serial numbers in the inquire -cl output. This will give you the current device order by device filename.
4. Execute the **nsrjb** command to determine the order of devices as configured in NetWorker. Drive entries towards the end of the nsrjb output list the device order as configured in NetWorker.
5. Compare the device ordering as determined in step 3 and step 4. If the device ordering in these two steps do not match, the device ordering has changed and the library will need to be reconfigured.

Correcting drive ordering changes

After a drive ordering change has taken place and the NetWorker software is no longer correctly communicating with devices, you can correct the problem within your NetWorker configuration by using the NetWorker Console or the **jbedit** command line program.

Using NetWorker Console to correct drive ordering changes

To correct drive ordering changes by using the NetWorker Console:

1. Ensure that you have a current backup of the resource database.
2. Delete the library resource in the NetWorker Console. [“How to delete a library” on page 125](#) provides details.
3. Rescan the library. [“Scanning for libraries and devices” on page 110](#) provides more information.

Using the jbedit command to correct drive ordering changes

To correct drive ordering changes by using the jbedit command:

1. Use the **jbedit** command with the **-d** option to delete devices from the NetWorker configuration
2. Use the **jbedit** command with the **-a** option to add the devices again.

[“Using the jbedit command” on page 117](#), or the UNIX man page for **jbedit** or the *NetWorker Command Reference Guide* provides more information on the **jbedit** command.

Clearing device ordering/serial mismatch errors from the NetWorker Console

After a device ordering error has been detected, a message is displayed in the Alerts and Notifications windows of the NetWorker Management Console, as well as the log files. The error message is similar to the following:

```
“Check system device ordering. Moving device on %s to service mode. To correct, scan for devices in NMC and re-enable the device.”
```

An Event ID for the error is also created, which will be removed along with the alert when the problem is resolved. To resolve the problem and clear the error message:

1. Disable the drive.
2. Perform one of the above procedures to correct the problem.

3. Re-enable the drive, and retry the operation that was being performed prior to receiving the error.

The Alert will be removed and the event dismissed.

Nonrewinding tape device usage (UNIX/Linux only)

Tape drives used as storage devices must be accessed by nonrewinding device files. The NetWorker server assumes that a tape is in the same position in which it was the last time it was accessed. If the operating system's device driver rewinds the tape, then the position is lost, and previously written data will be overwritten by the next backup.

The NetWorker configuration software automatically chooses the correct device pathname for tape devices. If the user specifies the pathname, then it must be nonrewinding, and it must follow the Berkeley Software Distribution (BSD) semantic rules.

For example, `/dev/rmt/0mbn`, where:

- ◆ The *b* satisfies the BSD semantics requirement on Solaris and HP-UX.
- ◆ The *n* specifies nonrewinding behavior on Solaris, HP-UX, Linux, and HP-Tru64.

On AIX, the number following the decimal selects the BSD and nonrewinding behavior and must be either 1 or 5 for NetWorker software (for example `/dev/rmt2.1`)

Note: Never change a device pathname from nonrewinding (`/dev/rmt/0cbn`) to rewinding (`/dev/rmt/0cb`). When the pathname is changed to rewinding, the data could only be saved, but never recovered. All but the last save are overwritten by later saves.

Block-size mode (UNIX/Linux only)

Ensure that the block-size mode for tape devices that are used with NetWorker software is set to variable. Otherwise, data recovery might fail. The procedure for setting the device block size varies depending on the operating system.

The operating system's documentation provides information about setting the tape device block size in the operating system.

Silos

This section describes silos and silo devices. Silos and libraries are managed similarly by NetWorker software.

A silo tape library (STL) is a peripheral that usually contains many storage devices. Silos are controlled by silo management software, which is provided by the silo vendor and installed on a silo server. The silo server cannot be the same computer as the NetWorker server.

The silo can be shared among many applications, systems, and platforms. As with libraries, silos make data and media operations more automatic. Silos can load, change, and manage volumes, and clean the devices automatically.

[“Media management in a silo” on page 305](#) provides information on silo-specific, media-management concerns.

NetWorker software interactions with a silo

A NetWorker server acts as a client of the silo management software, which resides on the silo server. The NetWorker server communicates with the silo through the Silo Tape Library Interface (STLI), which must be installed on the NetWorker server that uses the silo.

To access the volumes and devices in a silo, the NetWorker server sends a request to the silo management software, in the form of an STLI call. For example, to mount a volume in a silo device, the NetWorker media service sends a request to the silo management software to mount the volume into a particular device in the silo. The silo server responds to the request and mounts the volume in the requested device.

The silo management software controls many of the operations that NetWorker software controls with a library. For example, the silo management software keeps track of the slot where each silo volume resides, and might control the deposit and withdrawal of volumes, as well as automated cleaning of silo devices.

Installing a silo

To install a silo for use with NetWorker software:

1. Install the silo management software on the silo server.
2. Install the **STLI** on the NetWorker server, if required. For more information, refer to the documentation from the silo vendor.

Note: For example, for a NetWorker server or storage node running Windows to control an STK silo, the **libattach** program must be installed.

On UNIX systems, do not install the STLI library on the following models, because all the necessary software is installed when the NetWorker software is installed:

- IBM 3494 on Solaris and AIX
 - StorageTek on Solaris, AIX, and HP-UX
 - DAS on Solaris, AIX, and HP-UX
3. Ensure that the NetWorker server is properly connected to the media devices in the silo.
 4. Add the silo. [Chapter 3, “Configuring Libraries and Devices”](#) provides more information.

Note: When adding a DAS silo, your hostname configuration files (for example, `etc/hosts` and `etc/inet/ipnodes`) must use the shortname for the server.

Naming conventions for silo devices

The silo name of the storage devices is supplied during the configuration process. The silo name is the name that the silo management software uses to refer to the storage device. Depending on the type of silo, the device name can take several forms. This section describes the naming conventions of the currently supported silos.

StorageTek

The StorageTek (STK) silo management software uses either a program called ACSLS that runs on a UNIX system, or a program called Library Attach that runs on a Multiple Virtual Storage (MVS) system. These programs name devices according to a coordinate system based on the physical location of the devices in the silo.

For tape drives, the name consists of four digits separated by commas:

- ◆ The first digit refers to the automated cartridge system (ACS) with which the drive is associated.
- ◆ The second digit refers to the library storage module (LSM) in which the drive is located.
- ◆ The third and fourth digits refer to the panel and slot location in which the drive is located.

A typical name for an STK drive is similar to: 1,0,1,0.

Ask the silo administrator for the drive names of the devices that the NetWorker server can use. There is no way to get this information from the NetWorker server. To connect to more than one drive, determine the SCSI IDs for each drive and properly match the IDs to the silo names. If the operating system device names and silo names are accidentally swapped, it is only possible to mount and unmount volumes. Volumes cannot be read or written to after they are mounted. To reconfigure the device names properly, use the Administration program to change the order of the device names in the STL Device Names attribute of the library's Properties.

IBM 3494

The silo management software for the IBM 3494 names devices with an eight-digit number to identify the 3590 drives in the silo. Use the appropriate utility to obtain the device names, as follows:

- ◆ On an AIX system, the NetWorker software obtains the name of the device from the device driver and displays the device name as the default value.
- ◆ On a Solaris system, the IBM-supplied **mtlib** command (**mtlib -l library_name -D**) must be used to determine the names of all the devices in the 3494, if the silo name is configured by using the **jbconfig** command from the command-prompt, rather than through the configuration interface. Either ask the silo administrator which device is reserved for the NetWorker software, or test to determine which silo drive name matches with each Solaris device name.

DAS

The silo management software for the DAS silos is a program called DAS (Dual Attach Station). DAS acts as a front end for the silo control program called AMU. When the silo is configured, the silo administrator gives each drive a symbolic name. The symbolic name can be any alphanumeric string.

Set up DAS to work with NetWorker software

To set up DAS to work with NetWorker software the silo administrator must:

1. Configure DAS to accept commands from the NetWorker server or storage node computer.
2. Perform one of these tasks:
 - Use the **dasadmin allocd** command to allocate one or more devices to the NetWorker server or storage node.

- Configure the NetWorker server or storage node as an administrator, to be able to execute the **dasadmin allocd** command to allocate devices from the NetWorker server or storage node computer.

Note: The Console cannot be used to configure a DAS silo. To configure a DAS silo, use the **jbconfig** command.

Find the assigned names for DAS devices in the silo

To find the names assigned to the devices in the silo, use the **dasadmin** utility, which is installed with the NetWorker software.

To find the names:

1. Set these three environment variables:
 - **DAS_SERVER**, the hostname of the silo management server, which runs DAS.
 - **DAS_CLIENT**, the hostname of the NetWorker server or storage node.
 - **ACI_MEDIA_TYPE**, one of these values: 3480, CD_THICK, CD_THIN, DECDLT, 8MM, 4MM, D2, VHS, 3590, CD, TRAVAN, DTF, BETACAM, AUDIO_TAPE, or **DAS_MEDIUM**, same value as **ACI_MEDIA_TYPE**.
2. Type this command to see a list of drives and the hostnames to which they are allocated:

```
dasadmin ld
```

Releasing a silo device

When a silo device is configured for use with a NetWorker server, it is possible to restrict silo access only to the NetWorker server. These restrictions allow increased availability to the silo for those with full access. These restrictions can be lifted by using the Release Device feature.

To release a silo device:

1. In the **Administration** window, click **Devices**.
2. Open the **Libraries** folder in the navigation tree. The **Libraries** detail table appears.
3. Select a silo in the navigation tree or double-click a silo in the **Libraries** detail table to open the double-paned **Library Operations** view. The silo's drives are listed in the **Device** column. The slots are listed in the **Slot** column.
4. Right-click a silo in the **Slot** column, and select **Release Device**. A window appears and asks whether to release devices.
5. Click **Yes**. The **Library Operation** window appears and displays this message:

```
The library operation has started.
Please see the Monitoring->Operations screen for its status.
```
6. Click **OK**.
7. Repeat [step 1](#) through [step 6](#) for each device to be released.

Cleaning silo devices

Do not enable automated cleaning for silos in the NetWorker software. The automated device cleaning feature depends on fixed slot numbers, so it cannot be used in a silo, which does not have fixed slot numbers. For information about how to clean devices in a silo, refer to the silo manufacturer's software documentation.

Environment variables for DAS and StorageTek silos

Environment variables must be set for DAS and StorageTek silos. [Table 42](#) lists the environment variables to set.

Table 42 DAS and StorageTek environment variables

Silo model	Environment variables
DAS	<p>DAS_SERVER = <i>name_of_DAS_server</i> DAS_CLIENT = <i>name_of_system_as_defined_to_DAS_server</i> DAS_MEDIUM = <i>type_of_tape_drive_used</i> ACI_MEDIA_TYPE = <i>type_of_tape_drive_used</i> For DAS_MEDIUM and ACI_MEDIA_TYPE, use one of these values:</p> <ul style="list-style-type: none"> • 3480 • OD-Thick • OD-Thin • DECDLT • 8MM • 4MM • D2VHS • 3590 • CD • TRAVAN • DTF • BETACAM • AUDIOTAPE <p>To specify the cartridge-access port or range of ports for depositing or withdrawing volumes, use these environment variables rather than the -P ports option with nsrjb:</p> <ul style="list-style-type: none"> • DAS_INSERT_AREA_NAME=<i>port</i> • DAS_EJECT_AREA_NAME=<i>port</i> <p>The default values for DAS_INSERT_AREA_NAME is I01, and the default value for DAS_EJECT_AREA_NAME is E01.</p>
StorageTek	<p>For UNIX systems:</p> <ul style="list-style-type: none"> • CSI_HOSTNAME = <i>name_of_ACSLs_system</i> <p>The following commands should also be running on the system and can be included in the NetWorker startup script:</p> <ul style="list-style-type: none"> • <networker_binaries_path>/mini_el & • <networker_binaries_path>/ssi & <p>For Windows systems:</p> <p>The LibAttach Configurator program is available from StorageTek. It creates an ssi process, and a link is available to start the mini_el process from Start > Programs > LibAttach menu tree. Once installed and configured, it starts on reboot.</p>

Set the environment variables for UNIX systems

To set environment variables for DAS and StorageTek silos for UNIX systems:

1. Locate the NetWorker startup script.

- Using a text editor, open the NetWorker startup script and add the environment variables after the lines:

```
(echo 'starting NetWorker daemons:') > /dev/console
```

- Type the environment variables by using the format:

```
ENV_VAR = value
export ENV_VAR
```

- Restart the NetWorker server in order for the environment variables to take effect.

Table 43 lists the locations of the NetWorker startup scripts.

Table 43 NetWorker Startup Commands

Operating system	Startup command
Solaris, IRIX	/etc/init.d/networker
HP-UX, HP Tru64 UNIX	/sbin/init.d/networker
AIX	/etc/rc.nsr

Set the environment variables for Microsoft Windows systems

To set environment variables for DAS silos for Microsoft Windows systems:

- From the **Start** menu, select **Settings > Control Panel > System > Advanced > Environment Variables > New > System Variables**.
- Type the environment variable names.
- Restart the system in order for the environment variables to take effect.

Miscellaneous device operations

This section covers various additional device operation topics.

Refreshing enterprise library views on request

To update enterprise library views on request:

- From the **Console** window, click **Libraries**.
- In the navigation pane, select a server to update, or select the top item in the hierarchy to update library information for all NetWorker servers.
- Right-click the server, and select **Refresh**.

Changing the polling interval for enterprise library views

Enterprise library views are updated periodically without user intervention.

To change the update interval:

- From the **Console** window, click **Setup**.
- From the **Setup** menu, select **System Options**.
- In the **Polling Interval for NetWorker Libraries** field, type the appropriate time, in hours.

4. Click **OK**.

Stopping a device operation

To stop a device operation that is in progress:

1. In the NetWorker **Administration** window, click **Monitoring**.
2. Select the **Operations** tab.
3. Right-click an operation, and select **Stop**.
4. Click **Yes** to stop the operation, or **No** to resume it.

Display device operations messages

To display device operations messages:

1. In the NetWorker **Administration** window, click **Monitoring**.
2. Select the **Operations** tab.
3. Right-click an operation, and select **Show Details**.
The details window for the selected device appears.
4. Click **Close** to exit the window, or **Save** to save the message.

Sharing libraries among NetWorker hosts

The NetWorker software permits different NetWorker hosts (a NetWorker server or storage node) within a datazone to control individual devices within a library. This is known as library sharing.

The presence of a SAN within the datazone is not required for library sharing.

Dynamic Drive Sharing (DDS) does not support sharing libraries across datazones.

How library sharing works

Library sharing enables one NetWorker host to control the library's robotic arm, while other NetWorker hosts (as well as the host controlling the robotic arm) can each control and use specific library devices. A specific device can be controlled only by a single NetWorker host. [Figure 30](#) shows how multiple NetWorker hosts can share library devices.

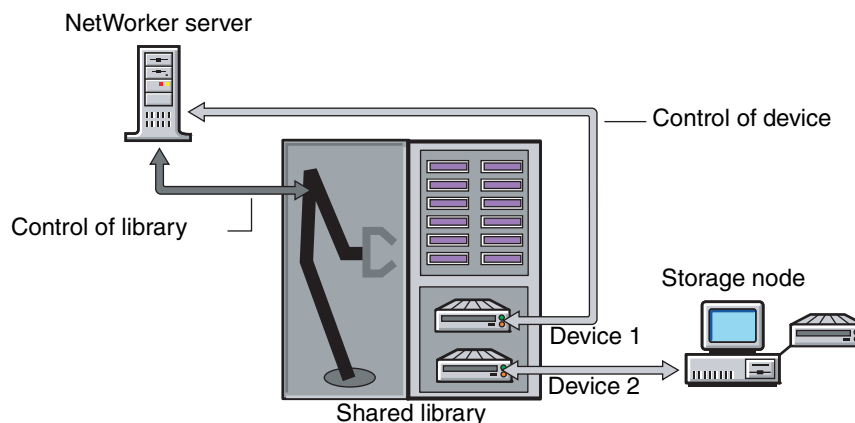

Figure 30 How library sharing works

Sleeping periods for library tasks

Library resources include attributes used by older, slower libraries that specify the number of seconds a library is inactive after certain operations (such as loading, unloading, or ejecting a volume). For example, once a tape is loaded, the library must read and, possibly, reposition the tape before the next operation can begin. This period of delay is known as *sleeping*.

While sleeping, the library cannot receive or perform other operations. Without the sleep period, the loading or unloading of volumes might fail.

The NetWorker software automatically configures default sleep periods. Change these values only when troubleshooting a library's performance, or if a NetWorker technical support specialist requests it. Typically, the higher the sleep values specified in the attributes, the longer it takes the library to perform the task. Be cautious when changing these values.

The sleep attributes and their default values are shown in [Table 44](#).

Table 44 Library resource sleep attributes

Attribute	Description	Default value
Load Sleep	Number of seconds that the NetWorker software waits for a library to complete loading a cartridge.	15 seconds
Unload Sleep	Number of seconds that the NetWorker software waits for a library to complete unloading a cartridge.	60 seconds
Eject Sleep	Number of seconds that the NetWorker software waits for an eject operation to complete.	60 seconds
Deposit Timeout	Number of seconds for a library to wait for a tape to be deposited in the mail slot before it times out.	15 seconds
Withdraw Timeout	Number of seconds for a library to wait for a tape to be withdrawn from the mail slot before it times out.	15 seconds
Cleaning Delay	Number of seconds that the NetWorker software waits between the completion of a drive cleaning operation and the ejection of the cleaning cartridge from the drive.	60 seconds
Idle Device Timeout	Number of minutes that the NetWorker software waits for a device to become idle after a backup has completed.	0 minutes
Port Polling Period	Number of seconds for a library to wait before polling a mail slot to check for the updated status.	3 seconds

Server Network Interface attribute

The Server Network Interface attributes in the Device resource are used to determine the network address or the hostname used by the **nsrmmnd** program to communicate with the NetWorker server. Similarly, the Server Network Interface attribute in the Library resource is used to determine the network address or the hostname used by the **nsrlcpd** program to communicate with the NetWorker server. These attributes are displayed in the NetWorker Console in diagnostic mode only. The Server Network Interface attributes are only relevant if the device or library is connected to a storage node.

Note: For devices, the `nsrmmd` program will read the Server Network Interface value for the first enabled device from the list of storage node devices, and each subsequent `nsrmmd` started by the NetWorker server will use the same value. Therefore, the NetWorker server will always use the same Server Network Interface value for every `nsrmmd` it starts or restarts, regardless of whether or not the Server Network Interface attribute is different for each device.

Tips for using libraries

This section provides additional suggestions for using libraries effectively and reliably.

Library notifications

The NetWorker server uses notifications to send messages about NetWorker events. Several preconfigured notifications, such as the following, provide information about various situations:

- ◆ Volumes in the library are 90% full.
- ◆ Library needs more volumes to continue.
- ◆ Library has a mechanical problem.
- ◆ Library device needs cleaning.
- ◆ Cleaning cartridge needs attention.

[“Notifications” on page 447](#) provides more information about notifications.

The NetWorker software automatically mounts a required volume as long as the volume is loaded in the library. If a recovery operation requires a volume that is not loaded in the library, the Tape mount request 1 notification sends an alert to **Monitoring > Alerts**, with a request to do something with a specific volume.

After a library problem is corrected, it might be necessary to mount a volume so the NetWorker server can continue to back up or recover files.

Recycling compared to adding more volumes

The NetWorker server saves files on volumes marked appen (appendable). If the volumes are marked full, they cannot receive backups.

If volumes are marked full, you can:

- ◆ Remove the full volumes and replace them with new media if the volumes are being kept for long-term storage.
- ◆ Change the volume mode to recyc (recyclable) if the data on the full volumes is not needed. The NetWorker server overwrites the data with new backups, but maintains the existing labels. [“Changing a volume’s mode” on page 291](#) provides information about changing the volume mode.

When all of the save sets on the volume have passed the time period specified by the retention policy, the mode of the volume automatically changes to recyclable.

There are advantages both to recycling media and adding more media to a pool. With recycling, the same volumes are used repeatedly, and there is no need to add new volumes to the pool. The volumes can, however, wear out over time and exhibit a higher failure rate.

On the other hand, if backups are to be stored for some time, then it might be necessary to add more media to the pool instead of recycling. For example, a library might need new volumes every three months if the company policy is to maintain the backups for a year. In this case, new media must be added to the pool until the volumes that contain expired or old backups can be recycled.

Resetting a library

A library must be reset each time the library and the NetWorker software become out of sync. [Example 5, “Host crash requires user intervention”](#) provides details. A library reset can be done using either the Administration interface or the command prompt.

Reset a library in the Administration interface

To reset a library in the Administration interface:

1. In the **Administration** window, click **Devices**.
2. Open the **Libraries** folder in the navigation tree. The **Libraries** detail table appears.
3. Select a library in the navigation tree or double-click a library in the **Libraries** detail table to open the double-paned **Library Operations** view.

The library's drives are listed in the pane on the left in the **Device** column. The library's slots are listed in the pane on the right.

4. Right-click a library in the **Device** column, and select **Reset**. You are prompted to reset the library.
5. Click **Yes**. The **Library Operation** window appears and displays this message:

```
The library operation has started.
Please see the Monitoring->Operations screen for its status.
```
6. Click **OK**.

Reset a library from the command-prompt

Use the **nsrjb -HE** command to reset a library from the command prompt. For example, the library inventory must be correct after adding drives to an SJI-compliant library, such as adding DLT7000 drives to an ETL 7/3500 device.

To make the NetWorker software aware of these new drives, execute **nsrjb -HE** to reset the library. The **-E** option reinitializes the library's element status. Some libraries can keep track of whether there is media in a component in the library. This feature is known as an *element status* capability.

A series of commands exists that allow direct interaction with libraries (**sj** commands) and tape drives (**cdi** commands). These commands should only be used by the most knowledgeable of NetWorker users, as the consequences of using them can be unknown. For information about these commands, refer to the *EMC NetWorker Command Reference Guide* or the UNIX man pages.

Using pools with libraries

If the backup strategy includes both full and nonfull backups, estimate the number of volumes needed for the full backups and assign them to the Full pool. This ensures that the full backups are located in a consecutive range of slots in the library. This allows all of the volumes to be removed at the same time. [“Media pools” on page 184](#) provides more information.

Device calibration

For information about the frequency and method for calibrating the loading mechanism for the device, refer to the library manufacturer’s documentation.

Reordering tape drive numbers (Microsoft Windows only)

If more than one tape drive is attached to the NetWorker server when both the server and drives are shut down, restart all of the tape drives, either before or immediately after the NetWorker server is restarted. If Windows does not locate all of its previously configured tape drives at the time of startup, it automatically reassigns the tape registry name.

For example, assume that these three tape drives are attached to the server:

- ◆ The first one, \\.\Tape0, is a 4 mm tape drive.
- ◆ The second, \\.\Tape1, is an 8 mm tape drive.
- ◆ The third, \\.\Tape2, is also an 8 mm tape drive.

If only the second and third tape drives are restarted, Windows reassigns the tape registry numbers so that the second storage device becomes \\.\Tape0 and the third storage device becomes \\.\Tape1. The tape registry numbers no longer match the defined storage devices within the NetWorker software. As a result, the server mishandles the drives and their volumes.

It might be easier to leave a nonoperational drive (device) attached to the server until a replacement is available. If the drive is removed, the name must be deleted, and then the new drive must be added.

To disable the drive, select **No** for the Enabled attribute in the device’s **Properties**.

Adding and removing media by using the library front panel

Certain media libraries allow for media to be added and removed by using the front panel display. This operation circumvents the NetWorker server's normal procedures for adding and removing volumes and may cause the server information to become out of sync with the library. Normally, you should use the NetWorker server procedures for adding and removing media, rather than the library's front panel display. This is more efficient and guarantees that the server and the library will be in sync.

If it is necessary to use the library's front panel display to add and remove volumes, do the following:

1. In the **Properties** window for the Library, on the **General** tab, set **Status Enabled** to **Service**.

Note: Putting the library in service mode will cancel all operations or wait for operations to complete that cannot be canceled, and then put the library into disabled mode.

2. Once the library is in disabled mode, use the library's front panel to add and remove tapes.
3. In the **Properties** window for the Library, on the **General** tab, set **Status Enabled** to **Enabled**.
4. Inventory the library. "[Inventorying library volumes](#)" on page 301 has information about inventorying libraries.

Note: When a library is partitioned, the NetWorker software does not become aware of the partitioning. This means that the entire physical library will be disabled, not just one partition.

This chapter covers these topics:

◆ Storage management operations.....	286
◆ Auto Media Management	288
◆ Volume operations	289
◆ Media handling errors	304
◆ Media management in a silo.....	305
◆ Volume save sets.....	310

Storage management operations

This section describes the components involved in the operation of storage volumes done through the NetWorker server. The details that describe a particular volume can be viewed, and often changed, by right-clicking the volume and making a selection from the menu. As with other Console functions, users can view and work with only those NetWorker servers for which they have access permission.

How the NetWorker server uses volume labels

A volume label is a unique internal code, applied by the NetWorker server, that initializes the volume for the server to use and identifies a storage volume as part of a specific pool. [“Using media pools” on page 184](#) provides more information about pools. Labeling a volume provides a unique name for tracking and recognizing the media, as well as references to volume labels in the records stored in the media database. The NetWorker server uses the media database records to determine which volumes are needed for backing up or recovering data.

When it labels a volume, the NetWorker server:

1. Verifies that the volume is unlabeled.
2. Labels the volume with the name specified in the **Volume Name** attribute by using one of the following:
 - The next sequential label from the label template that is associated with the chosen pool.

Note: If a recyclable volume from the same pool is relabeled, the volume label name and sequence number remain the same, but access to the original data on the volume is destroyed. The volume becomes available for new data.

- An override volume name that was entered by the user.

How the NetWorker server selects a volume

When a backup takes place, the NetWorker server searches for a volume from the appropriate pool to accept the data for backup. The available volumes are as follows:

- ◆ Mounted on stand-alone devices.
- ◆ Available for labeling and accessible to the NetWorker server through Auto Media Management or a library.
- ◆ Labeled for the appropriate pool and already mounted in a device, or are available for mounting, if a library is being used.

If two or more volumes from the appropriate pool are available, the server uses this hierarchy to select a volume:

1. Mounted volumes from the appropriate pool with the mode appendable are selected. This includes newly labeled volumes. If more than one mounted volume is appendable, the server uses this hierarchy:
 - a. Device availability. The server writes to the volume from the appropriate pool that is mounted on the device with the fewest current sessions.
 - b. Volume label time. The server writes to the volume with the oldest label time if the mounted volumes are appendable and session availability is not an issue.

2. If a library is in use and there is no mounted, appendable volume in the library, the server determines whether there is an unmounted, appendable volume available. This includes newly labeled volumes.
3. If multiple unmounted, appendable volumes are available, the volume with the oldest label time is selected.
4. If no mounted volumes are appendable and Auto Media Management is enabled, a mounted volume with the mode recyclable is selected. The server relabels and mounts the volume.

Note: A volume is automatically set to recyclable when all save sets on the volume, including partial save sets that span other volumes, are marked as recyclable.

5. If a stand-alone device is being used and Auto Media Management is not enabled, the server sends a mount request notification.
6. If a library is in use and no unmounted, appendable volumes exist, the server determines whether there is an unmounted, recyclable volume.
7. If Auto Media Management is not enabled, or if there are no appendable or recyclable volumes, the server sends a mount request notification.

[“Volume operations” on page 289](#) provides information about appendable and recyclable volumes.

Data recovery and volume selection

The NetWorker server determines which volumes are required for recovery. If the appropriate volume is currently mounted, the recovery begins. If the volume is not mounted and a library is used, the server attempts to locate and mount the volume. If a stand-alone device is used, or if the server cannot locate and mount the volume, the server sends a mount request notification.

If more than one volume is needed to recover the data, the NetWorker server displays all the volumes, in the order needed. During the recovery process, the server requests the volumes, one at a time.

Note: NetWorker will automatically unload volumes that have been placed in a jukebox device but have never been mounted (for example, `nsrjb -l -n <volume>`). Any command, such as the `scanner` command, that operates on volumes that have never been mounted will be affected by this behavior. To prevent NetWorker from unloading the volume, the device should be set to service mode while the command is being run.

Automatic volume relabel

If Auto Media Management is enabled and a volume has the mode recyclable, the server automatically relabels the volume. A volume is automatically set to recyclable when all save sets on the volume, including partial save sets that span other volumes, are marked as recyclable. The mode of a volume can also be manually changed to recyclable. [“Changing a volume’s mode” on page 291](#) provides information about changing the mode of a volume.

Auto Media Management

This section describes how NetWorker works with Auto Media Management.

Auto Media Management gives the NetWorker server automatic control over media loaded in the storage device. When Auto Media Management is enabled during device configuration, the NetWorker server automatically:

- ◆ Labels the volume (recognizes EDM labels and does not overwrite them).
- ◆ Mounts the volume.
- ◆ Overwrites volumes it considers to be unlabeled.

The NetWorker server considers a volume to be unlabeled under the following conditions:

- Has no internal label.
- Is labeled with information other than a NetWorker label.
- Is labeled with a NetWorker label, but the density indicated on the internal label differs from that of the device where the volume is mounted.
- ◆ Recycles volumes eligible for reuse that are loaded into the device.
- ◆ Because the Auto Media Management feature can relabel a volume that has a different density, it is possible, inadvertently, to overwrite data that still has value. For this reason, be careful if NetWorker volumes are shared among devices with different densities.
- ◆ When the Auto Media Management feature is not enabled, the NetWorker server ignores unlabeled volumes and does not consider them for backup.

Note: The NetWorker server considers volumes that were labeled by a different application to be valid relabel candidates if Auto Media Management is enabled. Once the NetWorker server relabels the volume, the previously stored data is lost.

Using Auto Media Management

This section describes how to use Auto Media Management.

Existing tapes with NetWorker labels

When Auto Media Management is used with tapes that have NetWorker labels that have not been recycled, the volumes must be removed from the media database before a utility such as **tar** is used to overwrite the labels. Also ensure that the tapes have been fully rewound before overwriting the labels. Auto Media Management can then properly relabel the tapes.

Enabling for stand-alone devices

The Auto Media Management feature can be enabled for stand-alone devices during manual device configuration, or from the Properties window after configuration.

When Auto Media Management is enabled for a stand-alone device, the following processes occur when a volume becomes full during a backup:

- ◆ A notification is sent that indicates that the server or storage node is waiting for a writable volume. Simultaneously, the NetWorker server waits for the full, verified volume to be unmounted.

Note: Nothing happens until the full volume has been unmounted by the operator.

- ◆ The device is monitored and the software waits for another volume to be inserted into the device.
- ◆ After a volume is detected, a check is performed to determine whether the volume is labeled. If so:
 - The volume is mounted into the device.
 - The NetWorker server checks to see whether the newly mounted volume is a candidate to receive data:
 - a. If yes, the write operation continues.
 - b. If no, the NetWorker server continues to wait for a writable volume to continue the backup.

Note: Again, nothing happens until the full volume has been unmounted by the operator.

- ◆ If the volume is recyclable and is a member of the required pool, it is recycled the next time a writable volume is needed.
- ◆ If the volume is unlabeled, it is labeled when the next writable volume is needed for a save.

Note: If a partially full volume is unmounted, the NetWorker server automatically ejects the volume after a few seconds. If a stand-alone device is shared between storage nodes, then Auto Media Management should *not* be enabled for more than one instance of the device. Enabling Auto Media Management for more than one instance of the stand-alone device will tie up the device indefinitely. No data is sent to the device and no pending message is sent.

Enabling for libraries

Auto Media Management is not enabled for libraries during autoconfiguration. Auto Media Management for a library can be set by changing the library's properties after configuration.

To enable auto media management:

1. In the server's Administration window, click **Devices**.
2. Select the **Libraries** folder in the navigation tree. The Libraries detail table appears.
3. Right-click the library, and select **Properties**. The **Properties** window appears.
4. Select the **Configuration** tab.
5. In the **Media Management** area, select **Auto Media Management**.
6. Click **OK**.

Volume operations

The volume operations sections describe the tasks involved in the operation of storage volumes done through the NetWorker server. Information about storage volumes is available for each device on a NetWorker server. All volume operations are performed in the Media task in the **Administration** window.

If a volume is not mounted when a backup is initiated, then one of three messages appears, suggesting that one of these tasks be performed:

- ◆ Mount a volume.
- ◆ Relabel a volume (only when Auto Media Management is enabled).
- ◆ Label a new volume (only when Auto Media Management is enabled).

During file recovery, the NetWorker server requests the volume name. If more than one volume is needed to recover the files, the server lists all the volumes in the order in which they are needed. During the recovery process, the server requests each volume, one at a time. If a library is used, the server automatically mounts volumes stored in the library.

The NetWorker server reports on the status of volumes using values such as:

- ◆ Volume name
- ◆ Written
- ◆ %Used
- ◆ Location
- ◆ Mode

Performing volume operations requires that the user have the correct permissions to use the NetWorker server and its storage nodes.

Viewing volume status information

To find information about a volume and its status:

1. In the server's **Administration** window, click **Media**.
Media-related topics appear in the navigation tree.
2. Select **Volumes**. The Volumes detail table appears. [Table 45 on page 290](#) lists the volume-related categories displayed in the Volumes detail table.

Table 45 Volumes detail (1 of 2)

Category	Description
Volume Name	Within the Administration interface, the volume name is the same as the name that appears on the volume label. At the end of the name, these designations might appear: <ol style="list-style-type: none"> 1. (A) indicates an archive volume. 2. (R) indicates a volume that is considered read-only. 3. (W) indicates that the volume is a write once, read many (WORM) device.
Barcode	Barcode label, if one exists.
Used	Indicates the amount of space currently in use on the volume (shown in KB, MB, GB, as appropriate). When Used is equal to full, there is no more space on the volume and the end-of-tape marker has been reached or an error with the volume has occurred.
% Used	An estimate of the percentage used, based on the total capacity of the volume, and on the specified value of the Media Type of the Device resource. When %Used is equal to 100%, it means that the value is equal to, or exceeds, the estimate for this volume. When the word "Full" appears in the % Used column, it is not based on an estimate of the volume's capacity. "Full" literally means that the volume is full. This attribute applies only to tape volumes. File type and advanced file type devices always display 0% Used.
Mode	Choices are appendable, read-only, and recyclable. Table 46 on page 291 lists the NetWorker volume modes and their definitions. " Changing a volume's mode " on page 291 provides information on changing volume modes.

Table 45 Volumes detail (2 of 2)

Category	Description
Expiration	Changing the expiration date is only possible from the command prompt. Use the nsrmm command to do this.
Location	Refers to an administrator-defined description of a physical location of the volume within the user's environment, for example, 2nd shelf, Cabinet 2, Room 42.
Pool	Name of the pool to which the volume belongs.

Table 46 Volume modes

Mode value	Meaning	Description
appen	appendable	This volume contains empty space. Data that meets the acceptance criteria for the pool to which this volume belongs can be appended.
man	manual recycle	This volume is exempt from automatic recycling. The mode can be changed only manually. The manual recycle mode and the option to change it are available from the Volumes menu. The default recycle mode is Auto.
(R)	read-only	The save sets on this volume are considered read-only. The mode can be changed only manually. “Using the read-only mode” on page 291 provides more information.
recyc	recyclable	The save sets on this volume have exceeded their retention policies.
full	full	The volume is full. There is no more space for data in the volume, and the save sets have not yet passed the time periods specified by the retention policies. This mode can be set only from the command-prompt. Use the nsrjb command with the -o option for libraries, and the nsrmm command with the -o option for stand-alone drives. Refer to the respective UNIX man pages of those commands (or to the <i>EMC NetWorker Command Reference Guide</i>) for more information.

Using the read-only mode

When the mode of a volume is read-only, no new data can be written to the volume. A read-only volume is *not* a write-protected volume. The save sets on the volume are still subject to their browse and retention policies, and the volume is not protected from being overwritten. When all the save sets on the volume have changed their status to recyclable, the mode of the volume changes to recyclable, and the volume becomes eligible for automatic recycling.

[“Changing a volume’s mode” on page 291](#) provides information on changing the volume mode.

Changing a volume’s mode

To change the mode of a volume:

1. In the server’s NetWorker **Administration** window, click **Media**.
2. In the navigation tree, select **Volumes**. The **Volumes detail** table appears, showing all of the server’s volumes.
3. Right-click a volume in the **Volumes detail** table, and select **Change Mode**. The **Change Mode** window appears.
4. Select a mode and click **OK**.

Recycling volumes

A volume's retention policy can be overridden by changing it to manual recycle. One reason to change to manual recycle is when save sets must be kept on a volume longer than its retention policy specifies. A volume marked for manual recycle can be changed back to recycle automatically, so that the volume once again uses its original retention policy.

Change a volume's recycle policy

To change a volume's recycle policy:

1. In the server's **Administration** window, click **Media**.
2. In the navigation tree, select **Volumes**. The **Volumes detail** table appears.
3. Right-click a volume in the **Volumes** detail table, and select **Recycle**. The **Recycle** window appears. It names the selected volume.
4. Select the recycle policy: **Auto** (default) or **Manual**.
5. Click **OK**.

Note: A volume that has been set to manual recycle retains that setting, even after relabeling. It must be explicitly reset to use auto recycle.

Labeling volumes

The NetWorker software labels each storage volume with a unique internal label that corresponds to a pool. During backup and other operations, this label identifies the pool to which a volume belongs. NetWorker software applies a label template to create a unique internal label for each volume. The NetWorker server uses label templates and pool configuration settings to sort, store, and track data on media volumes.

Note: Label templates are created in the Media task, but they are applied to volume labels in the Devices task. Data that exists on a tape is effectively gone after the tape has been relabeled.

Labeling a volume does the following:

- ◆ Writes a label on the volume.
- ◆ Adds the volume label to the media database.
- ◆ Prepares the tape to have data written to it.

During data recovery, the server asks for a specific volume that contains the required data, identifying the required volume by the name with which it was labeled.

[Chapter 7, "Sorting Backup Data"](#) provides information about label templates and pools.

Label templates

Several preconfigured label templates are supplied with the NetWorker software. These preconfigured label templates cannot be deleted. ["Naming label templates" on page 199](#) provides more information about label templates and preconfigured label template.

Label or relabel library volumes

Labeling volumes in a library is time-consuming, so consider labeling volumes before it is time to back up or recover files. Library volumes are labeled in the Devices task.

To label a library volume:

1. In the **Administration** window, click **Devices**.
2. Open the **Libraries** folder. The **Libraries** detail table appears.
3. In the navigation pane, right-click the appropriate library and select **Label**. The selected library's details appear, including divided tables for devices and slots. The **Label Library Media** window also appears.
4. The **Default** pool name appears in the **Target Media Pool** field. To select a different pool, click the field's down arrow for a list of other pool choices. The pool determines which label template is used in labeling the volume.
5. If the volume should not be recycled automatically, click **Allow Manual Recycle**. If **Allow Manual Recycle** is enabled when the volume is labeled, the volume is not automatically marked as recyclable when all of its save sets have expired. Only an administrator can mark the volume recyclable.

Note: A volume that has been set to manual recycle retains that setting, even after relabeling. A Manual Recycle policy cannot be changed back to Auto Recycle simply by unselecting the Manual Recycle checkbox. The volume must be explicitly reset to use auto recycle. ["Recycling volumes" on page 292](#) provides more information.

6. To be prompted before the existing label is overwritten, select **Prompt to overwrite label**.
7. Click **OK**. The **Library Operation** window appears, stating that the library operation has started.
8. Select **Monitoring**, then the **Operations** tab, to track the status of the label operation.
9. If **Prompt to overwrite label** was selected, right-click the label operation in the **Operations Status** window to confirm intent to overwrite the existing volume label with a new label, and select **Supply Input**.

A question window appears displaying this message:

Label <labelname> is a valid NetWorker label. Overwrite it with a new label?

10. Click **Yes** to overwrite the label with a new label, or **No** to cancel the label operation.

Note: When a volume is relabeled, that volume is initialized and becomes available for writing again.

Verifying the Label when volume is unloaded

If a SCSI reset is issued during a backup, the volume will rewind and NetWorker may overwrite the volume label. To detect if the label is overwritten in this circumstance, set the **Verify Label On Eject** attribute in the Device resource, or the **Verify Label On Unload** attribute in the Jukebox resource to Yes. When either of these attributes is set to Yes, NetWorker verifies that a volume label exists before ejecting the volume. If the volume label cannot be read, all save sets on the volume are marked as suspect and the volume is marked as full.

Empty slots in label operations

Slots that have been intentionally left empty (such as bad slots) are skipped during labeling operations. The NetWorker software logs a message similar to: "Slot 5 empty, skipping."

Using barcode labels

The option to label a library volume with a barcode is available during automatic device configuration. ["How to configure devices" on page 35](#) provides more information. This option can be set in the library's **Properties** tab after configuration.

Barcode labels make volume inventory fast and efficient. They eliminate the need to mount the volumes in a device. The library scans the external barcode labels with an infrared light while the volumes remain in their slots. Inventorying with barcode labels greatly reduces the time needed to locate a volume or determine the contents of a library.

Barcode labels also provide greater labeling accuracy. The labels are placed on the volumes before the volumes are loaded and scanned in the library. Once the library has scanned the barcode, the NetWorker server records and tracks the label in the media database. The NetWorker server uses barcode labels only to inventory volumes. A volume must have a label, but it need not have a barcode label.

Note: Libraries include hardware that reads barcode labels. The barcode information is then forwarded to the NetWorker server. Problems reading barcode labels indicate hardware problems. In the event of a barcode-related problem, consult the library's documentation or the hardware vendor.

Requirements for performing an inventory with barcodes

To perform an inventory by using barcodes, the following requirements must be met:

- ◆ The library must have a barcode reader.
- ◆ A barcode label must be present on the tape.
- ◆ The location field within the NetWorker media database must be correct or null. To view the location field, use the **mmlocate** command.

Configure a library to use volumes with barcodes

To select whether barcodes are used or matched after configuration:

1. In the **Administration** window, click **Devices**.
2. Open the **Libraries** folder. The **Libraries** detail table appears.
3. Right-click the appropriate library, and select **Properties**. The **Properties** window appears.
4. Select the **Configuration** tab.
5. In the **Media Management** area of the **Configuration** tab, select:
 - Bar Code Reader
 - Match Bar Code Labels
6. Click **OK**.

["Barcode labeling tips" on page 295](#) provides more information.

Use unmatched volume and barcode labels

Note: If unmatched volume and barcode labels are to be used, ensure that labels are attached to the outside of the volumes.

To use unmatched volume and barcode labels:

1. Apply barcode labels to the volumes.
2. Place the volumes with the barcode labels in the library.
3. In the **Administration** window, click **Devices**.
4. Open the **Libraries** folder. The **Libraries** detail table appears.
5. Right-click the appropriate library, and select **Properties**. The **Properties** window appears.
6. Select the **Configuration** tab.
7. In the **Media Management** area of the **Configuration** tab:
 - Select **Bar Code Reader**.
 - Ensure that Match Bar Code Labels is not selected.
8. Click **OK**. The NetWorker server uses the next available label from the label template for the volume name. It labels the volumes and records both labels in the media database.
9. Inventory the volumes to ensure that the NetWorker server has the most current volume information.
10. Use **Media > Volumes** to match the correct volume labels to the barcode labels. Consider making a list of the name correlations.

Note: If the barcode function is enabled, but no barcode label is affixed to the volume, an error message indicates that a barcode label does not exist.

Barcode labeling tips

The NetWorker server uses volume labels and barcode labels to identify volumes. Both label types are recorded in the media database. The volume label is also recorded internally on the media (internal volume label). The NetWorker server uses barcode labels to inventory volumes, and uses volume labels to identify the volumes needed for backup and recovery. A requirement to match the volume label with the barcode label can be set in the library's Properties window.

Follow these guidelines when using barcode labels with the NetWorker software:

- ◆ When NetWorker software relabels volumes automatically, it reuses the original volume label name. A label name can be changed only if the volume is relabeled manually. The NetWorker software scans the barcode label during the labeling process and updates the media database with the new volume name and its associated barcode label.
- ◆ Do not use identical barcode labels for any of the NetWorker volumes. The use of identical labels defeats the purpose of using barcode labels, which is to facilitate the inventory process and ensure label accuracy.
- ◆ Volume names must be unique on the NetWorker server. Give each volume a unique volume label. If a second volume is labeled with an existing barcode label and the Match Barcode Labels attribute in the library's properties is enabled, the

NetWorker server displays an error message and does not allow the second volume to be labeled. The error message identifies the library slots containing the two volumes with identical labels and the barcode label.

To correct this problem, either apply a different label to one of the volumes and restart the labeling process, or disable the Match Barcode Labels attribute in the library's properties while labeling the second volume.

- ◆ It is not necessary to label existing volumes with barcode labels if they are stored in a vault or offsite for long periods. These volumes are rarely, if ever, inventoried.
- ◆ Before using barcode labels on existing volumes, affix the barcode labels to them. Then, load and mount each volume individually, so that the NetWorker server can match the barcode label with the existing volume label.
- ◆ Record the volume label on the tape.
- ◆ A variety of barcode labels can be purchased from third-party vendors. Choose from among numeric labels, alphanumeric labels, or a special combination of numbers and characters. Furthermore, barcode labels can be ordered to match a current volume labeling scheme.
- ◆ Use a consistent labeling scheme. If volumes are labeled with the server name and an extension such as "001," order a range of labels starting with "server_name.001" and ending with "server_name.100", or as wide a range as necessary. Instructions for barcode labels should be provided with the library hardware documentation. Contact the hardware manufacturer with questions about barcode labels. A consistent labeling scheme helps better organize and track volumes. It also facilitates the inventory process if *all* of the volumes, use barcode labels.

Mounting and unmounting volumes

A volume must be mounted before files can be backed up. If no volume is mounted at the start of a backup, an error message appears and requests that a volume be mounted.

Mount or unmount a volume in a library

To mount a volume in a library:

1. In the **Administration** window, click **Devices**.
2. Open the **Libraries** folder in the navigation tree. The **Libraries** detail table appears.
3. Select a library in the navigation tree or double-click a library in the **Libraries** detail table to open the double-paned library operations view. The library's drives are listed in the **Devices** column, and its slots are listed in the **Slot** column.
4. To mount a volume:
 - a. In the **Devices** column, select the appropriate drive.
 - b. In the **Volume** column, right-click a volume to mount, and select **Mount**.
 - The **Library Operation** window displays this message:
The library operation has started.
 - The **Monitoring > Operations** screen displays its status.
 - c. Click **OK**.

5. To unmount the volume:
 - a. Right-click the device or the volume in the double-paned table view of the library and select **Unmount**.
 - The **Library Operation** window displays this message:
The library operation has started.
 - The **Monitoring > Operations** screen displays its status.
6. Click **OK**.

Mount or unmount a volume in a stand-alone tape drive

To mount a volume in a stand-alone drive:

1. Manually insert a volume in the stand-alone drive, or ensure that a volume is already loaded.

Note: In a stand-alone device, a volume that has been loaded into the drive is not considered to be mounted until it has been explicitly mounted in the user interface or from the command-prompt.

2. In the **Administration** window, click **Devices**.
3. Select **Devices** in the navigation tree. The **Devices detail** table appears.
4. Select the appropriate device. To mount the volume, in the **Devices detail** table, right-click the device and select **Mount**.
5. To unmount the volume, in the **Devices detail** table, right-click the device and select **Unmount**.
 - The **Library Operation** window displays this message:
The library operation has started.
 - The **Monitoring > Operations** screen displays its status.
6. Click **OK**.

Note: To perform an unattended backup using a stand-alone device, ensure that a labeled volume is mounted in the device before it is left unattended.

Label and mount a volume in one operation (stand-alone tape drive)

When more than one storage device is connected to the NetWorker server, the device to be used for labeling must first be selected from the list of available devices. Remember that labeling a volume makes it impossible for the NetWorker server to recover original data from that volume.

To label and mount a volume in a single operation in a stand-alone tape drive:

1. In the Administration window, click **Devices**.
2. Manually insert an unlabeled or recyclable volume in the NetWorker server storage device, or ensure that a volume of this type is already present for the NetWorker server to access.
3. Select **Devices** in the navigation tree. The **Devices detail** table appears.

4. Right-click the appropriate stand-alone device in the detail table, and select **Label**. The **Label** window appears:
 - a. Type a unique label name, or accept the default name associated with the selected pool.

Note: If the volume is unlabeled, the NetWorker server assigns the next sequential label from the label template associated with the selected pool. If a recyclable volume from the same pool is being relabeled, then the volume label name and sequence number remain the same. Access to the original data on the volume is destroyed, however, and the volume becomes available.

- b. Select a pool on the **Pools** menu. The NetWorker server automatically applies the label template associated with the **Default** pool unless a different pool is selected.
 - c. Select the **Manual Recycle** attribute if the volume should be manually recycled.

If the **Manual Recycle** attribute is enabled when the volume is labeled, the volume cannot automatically be marked as recyclable according to the retention policy. When a volume is marked manual recycle, the NetWorker server disregards the assigned browse and retention policies. Therefore, only an administrator can mark the volume recyclable.

Note: A volume that has been set to manual recycle retains that setting, even after relabeling. A Manual Recycle policy cannot be changed back to Auto Recycle by clearing the Manual Recycle checkbox. The volume must be explicitly reset to use auto recycle. [“Recycling volumes” on page 292](#) provides more information.

- d. The **Mount After Labeling** attribute is selected by default. The NetWorker server automatically labels the volume, and then mounts the volume into the device.
5. Click **OK**.
6. If the volume is recyclable, a message warns that the named volume is about to be recycled, and asks whether to continue. Click **Yes** to relabel and recycle the volume.
7. After a volume is labeled and mounted in a device, the volume is available to receive data. Since the NetWorker label is internal and machine-readable, place an adhesive label on each volume that matches that internal volume label.

[“Configure a library to use volumes with barcodes” on page 294](#) provides information on using barcode labels.

Note: If you are in the process of relabeling a mounted volume and you choose to not overwrite the existing label, the volume will be left in an unmounted state. To use this volume, mount it again.

Label without mounting

Volumes can be prelabeled without being mounted.

To label a volume without mounting, follow the same procedures as for labeling and mounting in one operation, but clear the **Mount After Labeling** attribute in the **Label** window.

Mount an uninventoried volume

To mount a volume that is not included in the library inventory, but which is a valid (properly labeled) NetWorker volume:

1. In the **Administration** window, click **Devices**.
2. Select **View > Diagnostic Mode** on the toolbar.
3. Manually insert the volume in an empty library slot.
4. Open the **Libraries** folder in the navigation tree. The **Libraries** detail table appears.
5. Select the library in the navigation tree in which the volume was manually inserted, or double-click the same library in the **Libraries** detail table. The **Libraries** detail table changes to the double-paned library operations view. The library's drives are listed in the **Devices** column, and its slots are listed in the **Slot** column.
6. In the **Devices** column, right-click the library in which the volume was manually inserted, and select **Inventory**. The **Inventory Library** window appears.
7. Type the slot number of the volume in both the **First** and **Last** field of the **Slot Range**.
8. Select **Operation Type**: either **Slow/Verbose** (the default) or **Fast/Silent**.
 - When **Slow/Verbose** is selected, the **Supply Input** option and icon on the **Operations** screen of the **Monitoring** window can be used to confirm the choice to relabel a volume. The device path appears in the **Device** field.
 - When **Fast/Silent** is selected, the **Supply Input** option and icon are not available, and relabeling proceeds automatically, without user input. The device path does not appear in the **Device** field. [“Supply user input” on page 400](#) provides details.
9. Click **OK**.
 - The **Library Operation** window displays this message:
The library operation has started.
 - The **Monitoring > Operations** screen displays its status.
The NetWorker software then inventories the specified slot.
10. Mount the inventoried volume as described in [Chapter 1, “Overview”](#).

Note: Unlabeled tapes may not be mounted for inventoring. Unlabeled tapes can only be mounted to be labeled. An attempt to mount an uninventoried volume by using unlabeled media results in an I/O error. The volume will also be ejected.

Automatic unmounting of volumes (idle device timeout)

At times, a volume that is mounted in one device might be needed by another device in the same library. For example, data being recovered by one device could span more than one volume, and the required volume could be mounted on another device. To address this need, a value can be defined in the Idle Device Timeout attribute for that particular library.

The Idle Device Timeout attribute, which applies only to shared libraries or libraries that are managed by AlphaStor software, specifies the number of minutes a mounted volume can remain idle before it is automatically unmounted from the device and returned to its slot, where it can then be accessed by another device. This attribute can

be useful in configuring shared drives. The attribute appears on the Advanced tab of a device's Properties when in diagnostic mode. The default value is 0 (zero) minutes, which means that the device never times out and the tape must be ejected manually. Select a time that is appropriate for the system configuration.

Using libraries with a volume import and export capability

The NetWorker software supports the use of the SCSI-II import/export feature found in many brands of library. Depending on the library model, this feature is also known as cartridge access port (CAP), mail slot, and loading port. The import/export feature deposits and withdraws (ejects) volumes from slots in the library. This feature enables the operator to deposit and withdraw cartridges without invalidating the device inventory list. Normally, if the operator opens the door to load or unload media, the element status of the autoloader is invalidated, which requires the reinitialization the library. The NetWorker server does not, however, automatically inventory the volume after a deposit and withdrawal.

The reinitialization usually consists of the following:

- ◆ An inventory of all slots
- ◆ A reset of the robotic arm
- ◆ A check to see whether each drive is working

The Deposit attribute causes a library to take the first available volume from the CAP and place it in the first empty library slot. The Eject/Withdraw attribute moves a volume from a slot (never from a drive) to the CAP.

Depositing a volume by using the import/export feature

Use these general instructions when working with a CAP. Specific instructions for working with a CAP can vary, depending on the library manufacturer. For specific instructions, refer to the library's documentation.

To deposit a volume from the CAP into a library:

1. Ensure that volumes are available in the CAP for deposit.
2. In the **Administration** window, click **Devices**.
3. Select **Libraries** in the navigation tree. The **Libraries detail** table appears.
4. Double-click the library in which to deposit the volume. The **Libraries detail** table changes to the double-paned library operations view.
5. Right-click either the device or the slot, and select **Deposit**. You are prompted to deposit the volume.
6. Click **Yes**. The **Library Operation** window displays this message:

The library operation has started.

The **Monitoring > Operations** screen displays its status.
7. Click **OK**.
8. Click **Monitoring** to go to the **Monitoring** window and select the **Operations** tab.
9. Right-click the **User Input** icon for the deposit job and select **Supply Input**. You are prompted to load the cartridges into the ports and type **Yes** to continue.
10. Click **Yes**.

11. Right-click the **User Input** icon for the deposit job and select **Supply Input** again. You are prompted to continue depositing volumes.
12. Click **Yes** to continue depositing volumes, or **No** when done.

Withdrawing a volume by using the import/export feature

To withdraw a volume from a library slot and place it in the CAP:

1. Ensure that the volume to be withdrawn is in a known slot, and that the CAP has an empty port to hold the withdrawn volume.
2. In the **Administration** window, click **Devices**.
3. Select **Libraries** in the navigation tree. The **Libraries** detail table appears.
4. Double-click the library from which the volume is to be withdrawn. The **Libraries** detail table changes to the double-paned library operations view.
5. Right-click the slot that contains the volume, and select **Eject/Withdraw**. You are prompted to withdraw the volume.
6. Click **Yes**.
 - The Library Operation window displays this message:
The library operation has started.
 - The **Monitoring > Operations** screen displays its status.
7. Click **OK**.
8. Select **Monitoring > Log** to see the result. A successful **Eject/Withdraw** operation ends with a **Succeeded** comment in the Log.

Note: If the library is partitioned into logical libraries and the import/export slots are shared between the partitions, you must withdraw volumes by using the `nsrjb` command with the `-P` option to specify the port or ports from which to withdraw volumes. Refer to the `nsrjb` man page or the *EMC NetWorker Command Reference Guide* for more information.

Inventorying library volumes

When the NetWorker software labels the contents of a library, the software registers the location of the volumes in the library slots when it assigns the volume label. This is called taking inventory. When the volumes in the library are inventoried, the NetWorker software reads the label of each volume and records its slot number. If the volumes are not moved in the library after they have been labeled, then the NetWorker server can access the volumes because each volume label is assigned to a specific slot.

If, however, the contents of the library are changed without being labeled, or if volumes are moved into new slots, the NetWorker software must be notified that the library now holds a different set of labeled volumes or that the volumes are in a different order. For example, if the library has more than one magazine, the volumes must be inventoried each time a magazine is removed and another one is loaded into the library.

When the volumes in a new magazine are labeled, there is no need to inventory them. The NetWorker software automatically records the slot number in which each newly labeled volume is located.

The NetWorker software can use barcode labels to speed up the inventory process. If the library supports the use of barcode labels, consider using them if large numbers of volumes and/or if the library contents change often. [“Using barcode labels” on page 294](#) provides more information on using barcode labels.

To inventory volumes in a library:

1. In the **Administration** window, click **Devices**.
2. Open the **Libraries** folder in the navigation tree. The **Libraries** detail table appears.
3. Select a library in the navigation tree or double-click a library in the **Libraries** detail table. The **Libraries** detail table changes to the double-paned library operations view.
4. Right-click anywhere within the **Devices** pane, and select **Inventory**. The **Inventory Library** window appears.
5. Type the numbers of the first and last slots to be inventoried in the **Slot Range** area.
6. Select **Operation Type**: either **Slow/Verbose** (the default) or **Fast/Silent**.
7. Click **OK**.
 - The **Library Operation** window displays this message:
The library operation has started.
 - The **Monitoring > Operations** screen displays its status.
8. Click **OK**. If the volumes do not have barcode labels, the NetWorker software must mount each volume, read its label, and unmount it. In this case, the inventory process can take some time to complete.

Working with volumes

This section describes how to work with volumes.

Removing volumes from the media database and online indexes

The main purpose of removing volume-based entries from the online indexes is to eliminate damaged or unusable volumes from the NetWorker server. A volume entry should be removed from the media database only if the volume has become physically damaged or unusable.

Both the client file index and media database entries can be removed. This action removes all information about the volume from the NetWorker server. Even if the database entries for a volume are removed, as long as the volume is undamaged, the data remains recoverable by using the **scanner** program.

In general, do not remove both the client file index and media database entries at the same time unless the volume is damaged or destroyed.

The presence of a clone of the particular volume prevents the deletion of the volume entry in the media database. This is because the NetWorker server accesses the cloned volume rather than the original volume as needed. The volume's entry in the media database is never actually purged. Because of this, removing volume entries from the media database is not a particularly effective way to reduce index size, although it does reduce the size of the online indexes by purging index entries associated with specific volumes.

Deleting volume data

To delete a volume:

1. In the **Administration** window, click **Devices**.
2. Open the **Libraries** folder in the navigation tree. The **Libraries** detail table appears.
3. Select a library in the navigation tree or double-click a library in the **Libraries** detail table.
 - The **Libraries** detail table changes to the double-paned library operations view. The library's drives and mounted volumes are listed, as well as its slots and all volumes, mounted or unmounted.
 - Only unmounted volumes can be deleted.
4. Right-click the volume to be deleted, and select **Delete**. The **Delete** window appears and displays a request to select from where the volume should be removed:
 - a. File and media index entries
 - b. File index entries only

Note: Do not remove the indexes of save sets on bad volumes.

5. Click the appropriate selection.
6. Click **OK**.
7. After a bad volume has been removed, type the **nsrck** command at the command prompt.

The **nsrmm** and **mminfo** UNIX man pages or the *EMC NetWorker Command Reference Guide* provide more information.

Marking a volume as full for offsite storage

When removing a volume from a library to store offsite, mark the volume as "full" so that the NetWorker software will not continue to ask for the volume.

To mark a volume as full, use the **nsrjb** command (for libraries) or the **nsrmm** command (for stand-alone drives) from the command-prompt. Note that the volume must be unmounted before this operation can be completed.

The format is as follows:

- ◆ For libraries:

```
nsrjb -o full valid
```
- ◆ For stand-alone drives:

```
nsrmm -o full valid
```

Where *valid* is the volume identifier of the volume. When a volume is marked as full, it is also marked as read-only.

You can also change the volume's Location attribute to an informational message, such as "Move to offsite storage in September 2009".

To change the volume's Location attribute:

1. In the **Administration** window, click **Media**. Media-related topics appear in the navigation tree.
2. Select **Volumes**. The **Volumes** detail table, which includes information about all of the server's volumes, appears.
3. Right-click a volume in the detail table, and select **Set Location**. The **Set Location** window appears.
4. Type a location description.

Note: This is descriptive information. Filling in this field does not send a volume anywhere.

5. Click **OK**.

Cloning volumes

["Volume cloning" on page 227](#) provides information about volume clone operations.

Media handling errors

The architecture of device drivers can produce media handling errors. The NetWorker software automatically retries a failed operation such as a **mount** or **read** of a volume. The number of times the NetWorker software retries the failed operation depends on the value of the Max Consecutive Errors attribute, which is set in the Advanced tab of the device's Properties window. The default value is 20. When the device's Max Consecutive Errors value is reached, the device stops retrying the operation and becomes disabled.

A mount or read operation might fail for several reasons, for example:

- ◆ Attempts to mount and read a damaged tape in a library can result in a loop of failed actions: the device might repeatedly try to mount the tape, replace it in the slot, and then retry the action with the same result. In this example, to bring the drive back into use, remove the damaged tape, then reenble the device.
- ◆ A drive that always reports a fixed number of failures before correctly mounting and reading a tape, even if the tape is not damaged, can cause a failure loop. In this example, ensure that the Max Consecutive Errors value is higher than the number of times that particular drive fails before working correctly.

Reenable a device

Once the number of retries equals the Max Consecutive Errors value, the device becomes disabled. After the problem that disabled the device has been fixed, the device (drive) must be reenbled before it can be used again.

To reenble a device:

1. Once the NetWorker computer is idle, remove any volume from the disabled drive and ensure that the drive is in good working order.
2. In the **Administration** window, click **Devices**. The **Devices** detail table appears.
3. Right-click the drive to be reenbled, and select **Properties**. The **Properties** window appears.
4. In the **Status** area of the **General** tab, set **Enabled** to **Yes**.

5. Click **OK**.

If the disabled drive is part of a library, it might be necessary to reset the device. To do this:

1. From the command prompt, change the path to the directory that contains the NetWorker binaries.
2. Type this command:

```
nsrjb -HE
```

Media management in a silo

More than one software application can use a single silo. Therefore, media management in a silo requires extra operations to prevent the NetWorker software from overwriting volumes used by other programs.

Numbering a silo slot

In a library, the NetWorker software specifies many functions by slot number. A library has a fixed number of slots, and NetWorker software uses the slot number to refer to a volume's physical location.

A silo works similarly, but a silo has a variable number of slots, starting at zero when it is first configured, and limited by the silo license purchased. The fundamental identifier of a silo volume is its barcode, or volser (volume serial number). The volser never changes over the life of a particular volume.

When the **nsrjb** command lists the contents of a silo, it also lists a slot number. Use the slot number to specify which volumes to mount, unmount, label, and inventory. Volumes are not always assigned the same slot number in the silo. The slot numbers in the silo are assigned dynamically, based on the sorted order of the barcodes that have been allocated. If additional barcodes that fall earlier in the sort sequence are allocated later, then the slot numbers change for all volumes that are later in the sequence.

The **nsrjb** UNIX man page or the *EMC NetWorker Command Reference Guide* provide more information.

Mounting and unmounting silo volumes

Mount and unmount operations for silos are the same as for library volumes:

- ◆ A volume must be mounted before it can be labeled, read, or had data written on it. The robotic mechanism mounts volumes in the devices of a silo.
- ◆ Volumes must be unmounted before they can be inventoried in a silo or removed from a NetWorker pool.

[“Mounting and unmounting volumes” on page 296](#) provides more information.

Labeling a silo volume

The NetWorker labels for volumes in a silo include both a regular NetWorker volume label (written on the media of the volume) and a silo barcode identifier. The volume label is usually based on the volume pool's label template. The barcode identifier is

written on a physical label on the outside of the volume, which the barcode reader in the silo can scan during inventory. “Labeling volumes” on page 292 and “Using barcode labels” on page 294 provide instructions on how to label silo volumes.

The use of barcodes with matching barcode labels and NetWorker volume labels, are both available for a silo. The Barcode Reader attribute must be selected, however the Match Barcode Labels attribute is optional. When both attributes are selected, the internal volume label that NetWorker software writes on the media of each volume will match the barcode label on the outside of the volume. When the labels match, it is easier to track volumes. But the NetWorker software does not require the internal and external labels to match.

With most silo management software, unlabeled volumes can be used. The silo management software assigns a “virtual” barcode label to those volumes. Although volumes can be used without barcodes, it is difficult to maintain integrity, since once the volume has been removed from the silo, the information about the virtual barcode is lost. Any volume without an actual barcode can be reinserted into the silo under a virtual barcode that NetWorker software (or another application) associates with some of the data.

Using a silo with volume import/export capability

NetWorker software supports the use of the import/export feature found in many brands of silos. Depending on the silo model, this feature is also known as CAP, mail slot, and loading port. The import/export feature deposits and withdraws volumes from slots in the silo.

The import/export feature enables the operator to deposit and withdraw cartridges without invalidating the device inventory list. If the operator opens the door to load or unload volumes, the element status of the autoloader is invalidated, requiring the time-consuming operation of reinitializing the silo. Note however, that NetWorker software does not automatically inventory the volume after a deposit.

Either NetWorker software or the silo management software can be used to control the import/export feature on the supported silos to deposit and withdraw volumes in a silo. But it is often more efficient to use the silo management software, especially to deposit or withdraw a large number of volumes.

On some silos (for example, StorageTek silos with the import/export feature set to automatic mode), the silo management software inserts volumes automatically. On these silos, the NetWorker software cannot be used to insert volumes.

To issue deposit and withdraw commands:

- ◆ To add and deposit volumes, type:

```
nsrjb -a -T tags -d
```
- ◆ To remove and eject/withdraw volumes, type:

```
nsrjb -x -T tags -w
```

where *tags* specifies the tags or barcodes of volumes in a remote silo.

Note: You cannot deposit a volume from the CAP (I/O Port) using the **nsrjb -d** command. A silo volume deposit requires the **-T** and **-a** options in sequence to add a volume in the media database.

The sequence of operations is: **nsrjb -d -T BarCode**

Ignore the error message that appears. **nsrjb -a -T Barcode**

Barcode IDs

A list of available barcode-labeled volumes is available from the silo management software. Refer to the silo manufacturer's documentation for how to generate the list of barcode IDs.

To specify a barcode identifier or template for the volumes from a command prompt, use the **-T** option with the **nsrjb** command. The **nsrjb** UNIX man page or the *EMC NetWorker Command Reference Guide* provides more information.

Allocating (adding) silo volumes

When volumes are added, the NetWorker server is directed to the volumes it can use.

Note: Because silos can be used by more than one software application, it is possible that a different application could read or write to volumes that belong to the NetWorker software. To prevent this from happening, most silo management software includes methods to limit access to volumes based on the hostname of the computer on which various programs run. The NetWorker software does not provide a method for setting up this sort of protection. The silo management software must configure it.

The addition of a volume causes the NetWorker software to query the silo management software to verify that the requested volume exists.

If the volume exists, the volume is allocated to the NetWorker software.

Add a silo volume

To add a silo volume:

1. In the **Administration** window, click **Devices**.
2. Open the **Libraries** folder in the navigation tree. The **Libraries** detail table appears.
3. Double-click a silo in the **Libraries** detail table to open the double-paned library operations view. The silo's drives are listed in the **Device** column, and its slots are listed in the **Slot** column.
4. Right-click a silo in the **Device** column, and select **Add**. The **Add Library Volumes** window appears, with the option to select either **Template** or **List** for barcode selection.
5. Select either **Template** or **List** to enter barcode volume identifiers.
 - The **Template** option allows the use of wildcards in creating a list of barcode IDs. Each entry should be on a separate line; for example, to name four tapes A01B, A02B, A03B, and A04B, type:

```
A0
1-4
B
```
 - The **List** option allows the entry of barcode IDs, separately. Each entry should be on a separate line; for example, type the name for each tape:

```
A01B
A02B
A03B
A04B
```
6. Type the appropriate volume identifiers in the **Barcodes** field.
7. Click **OK** (or **Cancel**, to continue adding to the list).

- Click "+" to add an entry.
- Click "<" to insert above a highlighted selection.
- Click "-" to delete an entry.

The **Library Operation** window displays this message:

```
The library operation has started.
```

```
The Monitoring > Operations screen displays its status.
```

8. Click **OK**. On return to the **Library** detail table, the added volumes will be shown.

Note: Silos do not display empty slots.

Troubleshooting

If the particular silo model does not automatically deposit the volume, then place the volumes in the insert area, right-click the volume and select **Deposit**.

To perform the **Deposit** and **Add** operations from a command prompt:

- ◆ On silos that require manual depositing, such as DAS:

```
nsrjb -a -T tags -d
```

where *tags* specifies the tags or barcodes of volumes in a remote silo. The **-d** flag performs the manual deposit.

- ◆ On silos where the silo management software deposits volumes automatically, such as StorageTek silos:

```
nsrjb -a -T tags
```

[“NetWorker software interactions with a silo” on page 273](#) provides more information on STLIs.

Deallocating (removing) silo volumes

When an STL volume in a silo is no longer needed, the volume can be deallocated from the silo. Deallocation is basically the same operation as removing a volume from a library. Although the volume cannot be loaded by the robotic mechanism, the entries in the NetWorker media database remain intact. If the volume is allocated again, NetWorker software can retrieve the data from it later.

Use deallocation when the silo license limits the number of usable slots, or when data is moved offsite for safer storage. When the license limits the number of slots, it might be possible to leave the volumes in the silo, if it is certain that the volumes will not be used by another application. That way, the volumes can easily be added again when the data on them must be accessible.

The allocation operation is not automatic. The volumes must be manually allocated again and inventoried to let the NetWorker server access the data. If the volume is to be removed from the silo for offsite storage, it must be removed with NetWorker software and then ejected from the silo by using the silo management software.

To remove a silo volume:

1. Unmount the volume from the device. [“Mounting and unmounting volumes” on page 296](#) provides instructions on unmounting volumes.
2. In the **Administration** window, click **Devices**.
3. Open the **Libraries** folder in the navigation tree. The Libraries detail table appears.

4. Double-click a silo in the **Libraries** detail table to open the double-paned library operations view. The silo's drives are listed in the **Device** column.
5. Right-click a silo in the **Device** column, and select **Remove**.
The **Remove Library Volumes** window appears, with the option to select either **Template** or **List** for barcode selection.
6. Select either **Template** or **List** to enter barcode volume identifiers.
 - The **Template** option allows the use of wildcards in creating a list of barcode IDs. For example, to name four tapes A01B, A02B, A03B, and A04B, type A0, 1-4, and B.
 - The **List** option allows the entry of barcode IDs, separately. For example, type the name for each tape: A01B, A02B, A03B, and A04B.
7. Type the appropriate volume identifiers in the **Barcodes** field.
8. Click **OK**.
 - The **Library Operation** window displays this message:
The library operation has started.
 - The **Monitoring > Operations** screen displays the silo's status.
9. Click **OK**. Notice that on return to the **Libraries** detail table, the removed volumes are no longer listed.

[“NetWorker software interactions with a silo” on page 273](#) provides information on STLs.

Inventoring a silo

Taking inventory of the volumes in a silo ensures that the mapping between slot number and volume name is correct, or reconciles the actual volumes in a silo with the volumes listed in the NetWorker media database.

The slot number of a silo volume is not a numbered slot inside the silo, as it is in a library. The slot number of a silo volume is the number of the volume's position in the list of volumes in a silo.

The tasks for inventoring volumes in a silo are the same as those for a library. [“Inventoring library volumes” on page 301](#) provides information about inventoring a library.

The NetWorker software examines all of the volumes in the silo and compares the new list of volumes to the NetWorker media database. Then the NetWorker software produces a message listing any volumes located in the silo that are not in the media database.

When the NetWorker software inventories a silo, the silo's barcode label reader reads the barcode labels on the outside of each volume. When a barcode matches an entry in the NetWorker media database, the volume does not need to be loaded. The inventory proceeds rapidly. If, however, the NetWorker software reads a barcode that does not match any of the entries in the media database, the volume must be mounted and read in order for a proper inventory to be taken.

Volume save sets

Information about individual save sets on volumes can be displayed from the Volumes detail table. Refer to this information to determine how resources are being used. For example, knowing the size of a save set can help in planning the amount of disk space needed for the online indexes.

Viewing save set details in the Volume Save Sets window

To view save set information in the Volume Save Sets window:

1. In the **Administration** window, click **Media**. Media-related topics appear in the navigation tree.
2. Select **Volumes**. The **Volumes** detail table, which includes information about all of the server's volumes, appears.
3. Right-click a volume in the detail table, and select **Show Save Sets**.
4. The **Volume Save Sets** window appears. [Table 47 on page 310](#) shows the attributes and their descriptions.
5. Click **OK** to close the **Volume Save Sets** window.

Table 47 Volume Save Sets window (1 of 2)

Category	Description
Client	Name of the NetWorker client computer that created the save set.
Save Set	Pathname of the file system containing the save set. This column also includes clone information. If the save set has a clone, the pathname is marked has clones and the cloned save set is marked clone save set.
SSID	Save set ID number.
Time	Date and time when the save set was created.
Level	Level of backup that generated the save set. This refers only to scheduled backups. For manual backups, the level is blank.

Table 47 Volume Save Sets window (2 of 2)

Category	Description
Status	Type of save set. Table 34 on page 224 provides a listing of save set values and descriptions.
Size	Save set size, in appropriate units.
Flags	<p>First flag shows which part of the save set is on the volume:</p> <ul style="list-style-type: none"> • c: Completely contained on volume. • h: Spans volumes, and head is on this volume. • m: Spans volumes, and a middle section is on this volume. • t: Spans volumes, and the tail section is on this volume. <p>Second flag shows save set status:</p> <ul style="list-style-type: none"> • b: In the online index and is browsable. • r: Not in the online index and is recoverable. • E: Marked eligible for recycling and may be overwritten at any time. • a: Aborted before completion. • i: Still in progress. <p>Optional third flag:</p> <ul style="list-style-type: none"> • N: NDMP save set • R: Raw partition backup (such as for a supported module). • P: Snapshot <p>Optional fourth flag:</p> <ul style="list-style-type: none"> • s: NDMP save set backed up by <code>nsrdsa_save</code> command to a NetWorker storage node.

Changing save set status within the Volume Save Sets window

To change the save set status within the **Volume Save Sets** window:

1. Select a save set.
2. Click **Change Status**. The **Change Save Set Status** window appears.
3. Select either:
 - Normal (default)
 - Suspect
4. Click **OK**, to leave the **Change Save Set Status** window.
5. Click **OK**, again, to leave the **Volume Save Sets** window.

Viewing save set details from the Save Set detail table

To view save set details from the Save Sets detail table:

1. In the **Administration** window, click **Media**. Media-related topics appear in the navigation tree.
2. Select **Save Sets**.

The **Save Sets** detail table appears with two tabs for configuring save set queries and listing save set details:

- The **Query Save Set** tab
 - The **Save Set List** tab
3. Select either tab. [“The Query Save Set tab” on page 312](#) and [“The Save Set List tab” on page 312](#) provide more information.

The Query Save Set tab

The **Query Save Set** tab allows users to search for save sets that meet specific criteria. Click the **Query Save Set** tab to access these query fields:

- ◆ Query Parameters area:
 - Client Name
 - Save Set
 - Save Set ID
 - Volume
 - Pool
 - Copies
 - Save Time (a range)
- ◆ Status area:
 - All
 - Select from:
 - Browsable
 - Scanned-In
 - In-Progress
 - Suspect
 - Recyclable
 - Recoverable
 - Aborted
- ◆ Type area:
 - All
 - Select from:
 - Normal
 - Deduplication
 - NDMP
 - Snapshot
 - Raw
- ◆ Maximum level area:
 - Full
 - 1 through 9
 - All

If no save sets are found that match the query parameters, an error message appears when closing the tab:

```
No save sets were found that matched the specified query.
```

The Save Set List tab

The **Save Set List** tab lists detailed save set information.

Click the **Save Set List** tab to view this tabular information:

- ◆ Save Set
- ◆ SSID (Save Set ID)
- ◆ Level

- ◆ Status
- ◆ Volume Name
- ◆ Type
- ◆ Client
- ◆ Size
- ◆ Files
- ◆ Pool
- ◆ Time

This chapter covers these topics:

◆ Choosing a recovery method.....	316
◆ Recovering by file selection	317
◆ Recovering by save set selection	325
◆ Recovering deduplication data	328
◆ Recovering with BMR.....	328
◆ Recovering encrypted data	328
◆ Disaster recovery	329
◆ Directing recoveries to another client.....	329
◆ Recovering online indexes for a NetWorker server	337
◆ Recovering the Console database	340
◆ Recovering backed-up client files from an old NetWorker server.....	340
◆ Recovering the Windows system configuration.....	341
◆ Recovering Windows volume mount points	347
◆ Recovering Windows DHCP and WINS databases	348
◆ Restoring Windows Content Index Server on Windows.....	348
◆ When you restart the service, the CIS re-indexes the entire catalog.....	349
◆ Restoring BOOT/BCD Data on Windows 2008 R2 and Windows 7	350

Choosing a recovery method

There are two main methods of recovering data:

- ◆ Recovery by file selection (index-based recovery)
- ◆ Recovery by save set selection

Recovery by file selection is the most flexible and easy to use method to recover data. However, save set recovery can be preferable especially when there is a large amount of data to be recovered or data is not available for quick access because it has passed its browse policy.

When to recover by file selection

Consider recovering data by file selection when:

- ◆ The exact name of the file or directory to recover is unknown and you want to browse the file system.
- ◆ A directed recovery is required. A directed recovery is a recovery where data that was backed up from one computer is recovered to another computer. [“Directing recoveries to another client” on page 329](#) provides information about directed recoveries.
- ◆ Only the files that are marked for recovery are recovered (not extra files).
- ◆ It is important to keep the recovery operation as simple as possible. A save set recovery can be a more complex operation.

When to recover by save set selection

Consider recovering data by save set selection when:

- ◆ You want to restore a large bulk of lost files, for example, in the event of a total disk failure. In this case, you do not have to mark individual files for recovery.
- ◆ The recovery of extra files is acceptable.
- ◆ Quick access to the backup data is not available because the data’s browse policy has expired. Quick access can be restored by re-creating the browsable client file index with the **scanner** program. However, this can be a time-consuming process. [“Restore a save set entry in the online indexes” on page 338](#) provides more information about the **scanner** program.
- ◆ Memory on the recovery host is an issue. Recovering by save set selection requires less memory than recovering by file selection.

Recovering by file selection

Recovering by file selection enables users to browse and select backed-up files and file systems for recovery. The earliest versions of files and file systems that are available for recovery are determined by the browse policy that was applied when the data was backed up. [“About browse and retention policies” on page 158](#) provides more information about browse policies.

To recover by file selection, the user on the local host (*user@localhost*) must:

- ◆ Belong to a NetWorker usergroup (identified as *User Groups* in the user interface) that has the “Recover Local Data” privilege. Members of the default NetWorker usergroups, Administrators, and Users, automatically have this privilege. [“NetWorker User Groups” on page 442](#) provides more information.
- ◆ Have operating system ownership of the files being recovered. The root user on UNIX or the Windows Administrator automatically have this privilege.
- ◆ Have local operating system “write” privileges to the local directories into which the files will be recovered. The root user on UNIX or the Windows Administrator automatically have this privilege.

If backed up data has exceeded its browse policy, you can still recover the data by using save set recovery. [“Recovering by save set selection” on page 325](#) provides more information about save set recovery. You could also recover data by re-creating the client file index with the **scanner** program. Re-creating the client file index enables users to browse and select files for recovery. However, re-creating the client file index can be a time-consuming process. [“Restore a save set entry in the online indexes” on page 338](#) provides more information about re-creating the client file index.

You can also recover files from other client computers by using directed recovery. [“Directing recoveries to another client” on page 329](#) provides details.

Recovering data on UNIX systems

To recover data to a UNIX client:

1. Start the **nwrecover** program by typing this command:

nwrecover

- Use the **-s servername** option with **nwrecover** to specify a particular NetWorker server on the network to use when recovering data. The `/servers` file, located in `/nsr/res/servers`, contains an entry for each available server.

If the **-s** option is not entered and there is only one server detected, that server will be connected to automatically. If there are no servers detected, or if there is more than one server available, the Change Server dialog box appears, allowing you to choose the server.

- Use the **-c client** option to specify a particular NetWorker client on the network. If the **-c** option is not used, the current client is assumed.

The **nwrecover** program displays a representation of the client’s file system.

2. Mark each directory and/or file to be recovered by selecting the checkbox next to each directory or file listed.

Note: To recover data from a scheduled backup other than the most recent one, you must change the browse time. See [“Recovering an earlier version of a file” on page 320](#).

3. Click **Start** to begin the recovery.
4. In **Recover Options** dialog box, select any appropriate options and click **OK**.
[“Resolving recovered data conflicts” on page 321](#) and [“Relocating recovered data” on page 323](#) have more information on options in the **Recover Options** dialog box.

The time it takes to recover the files, depends on file size, network traffic, server load, and tape positioning. During this time, messages appear so that you can monitor the recovery.

If the recovery is successful, a message similar to this appears:

```
Received 1 file(S) from NSR server server
Recover completion time: Tue Jan 21 08:33:04 2009
```

Recovering data on Windows systems

The information in this sections refers to using the NetWorker User program to recover data. If the NetWorker Module for Microsoft Applications Client User program is installed on the client computer, VSS data should be recovered with the NetWorker Module for Microsoft Applications Client User program. The *EMC NetWorker Module for Microsoft Applications Administration Guide* provides more information about the NetWorker Module for Microsoft Applications Client User program.

Note: If VSS is licensed and enabled, the databases must be taken offline before recovering Microsoft Exchange Server or SQL Server data.

To recover data to a Windows client using the NetWorker User program:

1. In the NetWorker **User** program, click **Recover** to open the **Source Client** dialog box.
2. Select the source client with the data you want to recover, and click **OK**. The local client is the default selection.
3. Select the destination client for the recovered data, and click **OK**. The local client is the default selection.
4. In the left pane of the **Recover** window, click the appropriate directory folder.

Note: If a drive letter is not present on the server, the drive is highlighted with a red question mark.

5. Mark each directory and/or file to be recovered by performing one of the following:
 - Select the directory or file, and from the **File** menu, select **Mark**.
To clear an item, select **Unmark** from the **File** menu.
 - Click the checkbox next to the directory or filename.
To clear an item, click the checkbox again.

If you select **My Computer** for recovery, all drives are recovered.

Note: To recover data from a scheduled backup other than the most recent one, you must change the browse time. [“Recovering an earlier version of a file” on page 320](#) provides details.

6. Click **Start** to begin the recovery.
 - It takes the NetWorker server a few moments to recover the files, depending on file size, network traffic, server load, and tape positioning. During this time, messages appear so that you can monitor the progress of the recovery.

Note: If an error occurs while recovering Microsoft Exchange Server or Microsoft SQL Server data by using VSS, you must restart the recovery process.

- If there is a naming conflict during recovery, you are prompted to select a workaround. “[Resolving recovered data conflicts](#)” on page 321 provides information about naming conflicts.
- If the recovery is successful, a message similar to this appears:

```
Received 1 file(S) from NSR server server
Recover completion time: Tue Jan 21 08:33:04 2009
```
- If the recovery fails due to a problem with VSS or a writer, an error message appears. Use the Windows Event Viewer to examine the event logs for additional information. VSS recovery error messages are also written to the NetWorker log file.

Note: The NetWorker User program does not recover any files in parallel. All files are recovered sequentially. To recover files using parallelism, perform recoveries from the command line.

Recovering data from the command prompt

You can also perform a recovery by using the **recover** program. For example, to recover C:\myfile from the server *jupiter*, type:

```
recover -s jupiter
Enter directory to browse: C:\recover: Current working directory is
C:\recover> add C:\myfile
C:\
1 file(s) marked for recovery
recover> recover
Recovering 1 file into its original location
Volumes needed (all on-line):
  jupiter.mars.com.001 at ../Tape.0

Received 1 file(s) from NSR server `jupiter'
Recover completion time: Tue Jan 21 08:33:04 2009
recover>
```

- ◆ If you do not specify the **-s** option with the **recover** command, the file(s) will be recovered from the NetWorker server defined in the `/nsr/res/servers` file that comes first in alphabetical order.
- ◆ To recover files or directories that begin with a dash (-) such as `-Accounting`, try one of the following options:
 - Run the **recover** command and enter **add ./-Accounting** to recover the `-Accounting` file or directory and its contents.
 - Run the **recover** command and use the **cd** command to change directories to `-Accounting` and then enter **add .** to add the current directory and its contents for recovery.

- If current directory is /temp and -Accounting is located in the /temp directory, run the **recover** command and then enter **add /temp/-Accounting** and the file or directory -Accounting and its contents will be added for recovery.
- ◆ You cannot recover Windows SYSTEM or VSS SYSTEM save sets by using the **recover** command in interactive mode. For information about recovering Windows SYSTEM save sets, see [“Recovering the Windows system configuration” on page 341](#). The *EMC NetWorker Command Reference Guide* or the UNIX man pages provide information about **recover** command.
- ◆ To avoid using the Windows version of **recover.exe** on Windows operating systems, do one of the following:
 - Include <NetWorker_install_path>\bin\recover.exe at the command prompt
 - Ensure that <NetWorker_install_path>\bin is listed before %SystemRoot%\System32 in the \$PATH environment variable.

Recovering an earlier version of a file

You can browse previous backups to recover an earlier version of a file. This is useful if the required data was deleted from the current file system and is not present in the most recent backup.

The earliest versions of files and file systems that are available for recovery are determined by the browse policy that was applied when the data was backed up. For example, to recover a lost file that was backed up six months ago requires the appropriate browse policy. [“About browse and retention policies” on page 158](#) provides more information about browse policies.

Recovering an earlier version of a file

Before changing the browse time to recover an earlier version of a file, verify that no files are currently marked for recovery. If files are currently marked for recovery and the browse time is changed, the marked files will still be selected for recovery even though they may have been backed up after the selected browse time.

On Windows

To recover an earlier version on Windows:

1. In the NetWorker **User** program, click **Recover** to open the **Source Client** dialog box.
2. Select the source client whose data you want to recover, and click **OK**.
3. Select the destination client for the recovered data, and click **OK**.
4. From the **View** menu, select **Change Browse Time**.
5. In the **Change Browse Time** dialog box, select a new day within the calendar. Select **Previous Month** or **Next Month** to change from the current month.
6. In the **Time** field, change the time of day by typing an hour, minute, and the letter a (for A.M.) or p (for P.M.). Use the 12-hour format.
7. Click **OK**.
8. Select the files or directories to recover as described in [“Recovering by file selection” on page 317](#).

Note: If there are no entries for files backed up at the time selected in the Time field, the files that were backed up at the closest preceding time are displayed.

On UNIX

To recover an earlier version on UNIX:

1. In the **nwrecover** program, select **Change Browse Time** from the **Options** menu.
2. In the **Choose Date** dialog box, select a new day within the calendar. Click the forward or back arrows to change from the current month.
3. In the optional **Time** attribute, change the time of day to use by changing the displayed time. Use the 24-hour format.
4. Click **OK**.
5. Select the files or directories to recover as described in [“Recovering by file selection” on page 317](#).

Note: If there are no entries for files backed up at the time selected in the **Time** attribute, the files that were backed up at the closest preceding time are displayed.

Resolving recovered data conflicts

By default, the NetWorker server attempts to recover data to its original location. If a name conflict occurs, the NetWorker software can respond either automatically or on an file-by-file basis.

Resolving data conflicts on UNIX

The **Recover Options** dialog box, which appears each time a recovery is started, provides options for resolving naming conflicts during recovery. [Table 48 on page 321](#) lists the available conflict resolution options.

Table 48 Options for resolving naming conflicts on UNIX

Option	Action
Relocate files to	Recovers selected files to the specified location.
Rename recovered file	Renames the recovered files by appending each conflicting name with .R.
Discard recover file	Discards the recovered file and keeps the existing file.
Overwrite existing file	Replaces the file on the file system with the recovered version.
Prompt me at every file conflict	If selected, redisplay the Naming Conflict dialog box for every file that has a naming conflict.

Resolving data conflicts on Windows

By default, the Naming Conflict dialog box appears each time there is a filename conflict during a recovery. [Table 49 on page 322](#) lists the conflict resolution options available during a recovery.

Table 49 Options for resolving naming conflicts on Windows

Option	Action
Rename Recovered File	Renames the recovered files. “Rules for renaming file on Windows” on page 322 provides more information.
Discard Recover File	Discards the recovered file and keeps the existing file.
Overwrite Existing File	Replaces the file on the file system with the recovered version.
Suppress Further Prompting	Automatically performs the selected option if additional conflicts are encountered during this recovery operation.

Rules for renaming file on Windows

When a naming conflict is encountered during recovery, the NetWorker server uses these guidelines to rename the recovered file:

- ◆ By default, a tilde (~) is appended to the beginning of the name of the recovered file:
~<filename>
- ◆ If a file named ~<filename> already exists, the recovered file is renamed ~00_<filename>.
- ◆ If a file named ~00_<filename> already exists, the recovered file is renamed ~01_<filename>, and so forth to ~99_<filename>.
- ◆ If this fails, the file will not be renamed automatically:
 - If the **recover** command is being used, the NetWorker server fails to rename the file.
 - If the NetWorker **User** program is being used, the user is prompted to type a name for the file.

Resolve name conflicts automatically on Windows

You can configure the NetWorker software to resolve all name conflicts automatically before a recovery is started.

To automatically resolve name conflicts before starting a recovery:

1. In the NetWorker **User** program, click **Recover** to open the **Source Client** dialog box.
2. Select the source client with the data to recover, and click **OK**.
3. Select the destination client for the recovered data, and click **OK**.
4. Select **Recover Options** from the **Options** menu.
5. Select a conflict resolution option, as described in [Table 49 on page 322](#) and then click **OK**.

Another way to avoid name conflicts is to relocate the recovered data prior to recovery. [“Relocating recovered data” on page 323](#) provides more information.

Relocating recovered data

By default the NetWorker server attempts to copy a recovered file to its original location. If an existing file on the local disk has the same name as the file being recovered, the server prompts for instructions on how to recover the file.

Alternatively, you can instruct the NetWorker server to relocate the recovered file prior to the recovery.

Relocate recovered data on Windows

To relocate recovered data:

1. In the NetWorker **User** program, click **Recover** to open the **Source Client** dialog box.
2. Select the source client with the data to be relocated, and click **OK**.
3. Select the destination client for the data, and click **OK**.
4. Select **Recover Options** from the **Options** menu.
5. In the **Relocate Recovered Data To** field, type the directory where the data should be relocated and then click **OK**.

Note: Provide the full pathname of the relocation directory.

6. Perform a data recovery as described in [“Recovering data on Windows systems” on page 318](#).

Relocate recovered data on UNIX

The **Recover Options** dialog box, which appears each time a recovery is started, allows you to select the location to which files should be relocated during recovery.

To relocate recovered data:

1. In the **nwrecover** program, start a recovery.
2. In the **Relocate file to** field of the **Recover Options** dialog box, click **Browse** and select the directory where the data should be relocated, or type the full pathname.
3. Click **OK**.

Viewing versions of a directory or file

Use the Versions option to view the backup details of a directory or file. Details include the name, size, modified time, volume, location, and so on.

View version details on Windows

To view the version details of backed-up data:

1. In the NetWorker **User** program, select **Relocate** from the **Options** menu.
2. Select the source client with the backup versions to view, and click **OK**.
3. Select the destination client for the recovered data, and click **OK**.
4. Highlight the file or directory to be recovered.
5. From the **View** menu, select **Versions**.

Versions are sorted according to the backup time (the most recent backup first). The selected version matches the one currently selected in the **Recover** window.

View version details on UNIX

To view the version details of backed-up data:

1. In the **nwrecover** program, select an item to view its details.
2. From the **Selected** menu, select **Versions**.

Versions are sorted according to the backup time (the most recent backup first).

Searching for a recoverable file

Users can search for and recover the most recently backed-up version of a file.

On Windows

To search for a recoverable file:

1. In the NetWorker **User** program, click **Recover** to open the **Source Client** dialog box.
2. Select the source client with the data to recover, and click **OK**.
3. Select the destination client for the recovered data, and click **OK**.
4. From the **File** menu, select **Find**.
5. Type the name of the file or directory. Use wildcards to expand the search; without wildcards, partial filenames result in a no match being found.

On UNIX

To search for a recoverable file:

1. In the **nwrecover** program, select **Find** from the **File** menu.
2. Type or select the base directory that will be searched.
3. Type the name of the file or directory. Use wildcards to expand the search, or use the **Contains** drop-down button to modify search criteria.
4. Click **More Options** to further modify the search criteria, such as selecting a time of the backup and an owner of the file.
5. Click **Find**.

Viewing the volumes required for data recovery

Users can view a list of the volumes needed to recover files and directories.

On Windows

To view a list of the volumes required for data recovery:

1. In the NetWorker **User** program, click **Recover** to open the **Source Client** dialog box.
2. In the **Source Client** dialog box, select the client with the data to be recovered and click **OK**.
3. In the **Destination Client** dialog box, select the client to which the data will be recovered and click **OK**.
4. In the **Recover** window, select the item with the volume requirements to be viewed.
5. Select **Required Volumes** from the **View** menu.

On UNIX

To view a list of the volumes required for data recovery:

1. In the **nwrecover** program, select the item with the volume information requirements to be viewed.
2. Select **Required Volumes** from the **Selected** menu.

Recovering by save set selection

Save set recovery enables you to recover data from a save set rather than by browsing and selecting files for recovery. Generally it is preferable to browse and select files for recovery. However, save set recovery may be preferable when there is a large amount of data to recover or when quick access to the backup data is not available because the data's browse policy has expired. [“Choosing a recovery method” on page 316](#) provides more information about deciding whether to perform a save set recovery or a recovery by file selection.

Backed up data that has not exceeded its retention policy is eligible to be recovered by save set recovery. However, if backed up data has exceeded its retention policy, it may still be recoverable by using the **scanner** program. [“About browse and retention policies” on page 158](#) provides information about retention policies. [“Restore a save set entry in the online indexes” on page 338](#) provides information about recovering data that has exceeded its retention policy.

Note: When you perform a save set recover operation, recover the last full backup first, then recover levels 1 to 9 and incremental backups in the chronological order that they were backed up. [“Backup levels” on page 147](#) provides information about the relationship between full backups, backup levels 1 to 9, and incremental backups.

Recover a save set on Windows

Note: Only members of the Windows Administrators group have permission to perform a save set recovery on Windows. In the case of a remote NetWorker client, members of the client's Windows Administrators group must have the Recover Local Data privilege to perform the save set recover. Members of the server's Windows Administrators group automatically have this privilege.

To perform a full save set recovery of a client:

1. In the NetWorker **User** program, select **Save Set Recover** from the **Operation** menu.
2. In the **Source Client** dialog box, select the appropriate client and click **OK**.
3. From the **Save Set Name** list of the **Save Sets** dialog box, select the name of the appropriate save set.
4. Select the particular version of the save set (if there are multiple versions).
You can also select to recover the cloned version of a save set if one is listed.
5. Click **OK** to begin the recovery. The recovery status appears in the **Recover Status** window.

Recover a save set on UNIX

Note: Only root has the permission to perform a save set recovery on UNIX. In the case of a remote NetWorker client, root@*client* must have the Recover Local Data privilege to perform the save set recover. The root@<networker_server> user automatically has this privilege.

To perform a full save set recovery of a client:

1. In the **nwrecover** program, select **Recover Save Set** from the **Operation** menu.
2. From the **Name** list, select the name of the appropriate save set.
3. In the **Instances** list, select the particular version of the save set (if there are multiple versions).
4. Click the **Recover** button.
5. Select the appropriate options in the **Recover Options** dialog box and click **OK**.

Recover a save set from the command prompt

To perform a save set recovery from the command prompt, use the **recover** command with this syntax:

```
recover -s servername -S ssid -d directory_path
```

The *EMC NetWorker Command Reference Guide* or the UNIX man pages provide information about the **recover** command.

Recover individual files or directories from a save set on Windows

To recover specific data from a save set:

1. In the NetWorker **User** program, select **Save Set Recover** from the **Operation** menu.
2. In the **Source Client** dialog box, select the appropriate client and click **OK**.
3. From the **Save Set Name** list of the **Save Sets** dialog box, select the name of the appropriate save set.
4. Select the particular version of the save set (if there are multiple versions).
5. Click **Files** to open the **Files** dialog box.
6. Type the exact names of the files and directories (including the full case-sensitive paths) that you want to recover in the **Files** text box. Each file or directory must appear on a separate line.
7. Click **OK** to begin the recovery. The recovery status appears in the **Recover Status** window.

Recover individual files or directories from a save set on UNIX

To recover specific data from a save set on UNIX, perform a regular recovery as described at [“Recovering data on UNIX systems” on page 317](#).

View volumes required for save set recovery

Use this procedure to display a list of each volume that needs to be available to recover a save set. If no volumes appear during this procedure, then no entries for the volume exist in the media database. Use the **scanner** program to re-create the media database entries. [“Restore a save set entry in the online indexes” on page 338](#) provides information about using the **scanner** program to re-create the media database.

- On Windows** To view a list of the volumes required for a save set recovery:
1. In the NetWorker **User** program, select **Save Set Recover** from the **Operation** menu.
 2. In the **Source Client** dialog box, select the appropriate client and click **OK**.
 3. From the **Save Set Name** list of the **Save Sets** dialog box, select the name of the appropriate save set.
 4. Select the particular version of the save set (if there are multiple versions).
 5. Click **Required Volumes** to display the volumes required for the recovery.
- On UNIX** To view a list of the volumes required for a save set recovery:
1. In the **nwrecover** program, select the appropriate save set instance.
 2. Select **Required Volumes** from the **Selected** menu.

Relocate recovered save set data

You can relocate recovered save set data from the data's original backup location to another place on the file system.

- On Windows** To relocate recovered save set data:
1. In the **nwrecover** program, select **Save Set Recover** from the **Options** menu.
 2. In the **Source Client** dialog box, select the appropriate client and click **OK**.
 3. Click **Options** to open the **Recover Options** dialog box.
 4. Type the path in the **Relocate Recovered Data To** text box or click **Browse** to select the destination directory.
 5. Click **OK**.
- On UNIX** The **Recover Options** dialog box, which appears each time a recovery is started, allows you to select the location to which files should be relocated during recovery.
- To relocate recovered data:
1. In the **nwrecover** program, start a recovery
 2. In the **Relocate file to** field of the **Recover Options** dialog box, click **Browse** and select the directory where the data should be relocated, or type the full pathname.
 3. Click **OK**.

Resolve conflicts with recovered save set data

You can configure the NetWorker server to resolve conflicts during the recovery.

On Windows

To resolve data recovery conflicts with save set data:

1. In the NetWorker **User** program, select **Save Set Recover** from the **Operation** menu.
2. In the **Source Client** dialog box, select the appropriate client and click **OK**.
3. Click **Options** to open the **Recover Options** dialog box.
4. Select the appropriate option for the **Duplicate File Resolution** attribute. [Table 50 on page 328](#) lists the options and actions taken for the Duplicate File Resolution.

Table 50 Options for resolving save set recovery naming conflicts on Windows

Option	Action
Always Prompt	Indicates that automatic naming conflict resolution is disabled.
Rename the Recovered File	Renames the recovered files. “Rules for renaming file on Windows” on page 322 provides more information.
Discard the Recover File	Discards the recovered file to prevent overwriting the existing file.
Overwrite the Existing File	Replaces the file with the recovered version.

5. Click **OK**.

On UNIX

The **Recover Options** dialog box, which appears each time a recovery is started, provides options for resolving naming conflicts during recovery. [Table 48 on page 321](#) lists the available conflict resolution options.

Recovering deduplication data

The *NetWorker Avamar Integration Guide* and the *NetWorker Data Domain Depulication Devices Integration Guide* provides more information on how to recover depulication data.

Recovering with BMR

[Chapter 26, “Support for HomeBase”](#) describes how to perform a BMR recovery or server migration with Homebase. The EMC HomeBase product documentation provides details and instructions about HomeBase Server and HomeBase Agents.

[“Support for Windows 2008 / 2008 R2 / Windows 7 Disaster Recovery” on page 597](#) provides information on performing a Windows BMR recovery with NetWorker.

Recovering encrypted data

To recover data that was encrypted with the current AES pass phrase, no special action is required. However, to recover data that was encrypted with an AES pass phrase that is different than the current pass phrase, follow the procedure in this section. The current pass phrase is listed in the Datazone Pass Phrase attribute of the NetWorker server. [“Set the Datazone pass phrase for a NetWorker server” on page 77](#) provides more information.

To recover AES encrypted data that was not encrypted with the current pass phrase, use the **-p** option with the command that is being used to recover data. For example:

```
recover -p pass_phrase
```

```
winworkr -p pass_phrase
```

To enter multiple pass phrases with the **-p** option, type:

```
recover -p pass_phrase1 -p pass_phrase2 -p pass_phrase3
```

Note: If an incorrect pass phrase or no pass phrase is entered, encrypted data is not recovered. Instead, the filenames will be created without data. However, if unencrypted data is also selected for recovery, it will be recovered.

Disaster recovery

For Windows disaster recovery, there are automated solutions. For more information see the following:

- ◆ [Chapter 23, “Support for Windows XP and 2003 Automated System Recovery,”](#)
- ◆ [Chapter 24, “Support for Windows 2008 / 2008 R2 / Windows 7 Disaster Recovery,”](#)

For non-automated Windows and UNIX disaster recovery information, refer to the *EMC NetWorker Disaster Recovery Guide*.

Notes on the use of the scanner program

Do not use the **scanner** program to restore the bootstrap after a disaster in which you lose the media database or the server’s res files. Instead, use the **mmrecov** command to restore these files.

Note: The **scanner** program can recover only the hash data from deduplication node backups if the save sets have been deleted from the Avamar server that is the deduplication node. If the backup-to-tape method described in [“Backup-to-tape for Avamar deduplication clients” on page 233](#) is used regularly, it provides a tape backup of the deduplicated data up to a particular point in time.

Directing recoveries to another client

Directed recovery allows a NetWorker administrator to remotely recover backed-up data from a NetWorker client (the source client) and direct it to another NetWorker client (the destination client).

Notes: Directed recovery of the Windows SYSTEM STATE is not supported.

[Figure 31 on page 330](#) shows a user on client saturn performing a directed recovery of data from a remote client (source) to the client mars (destination).

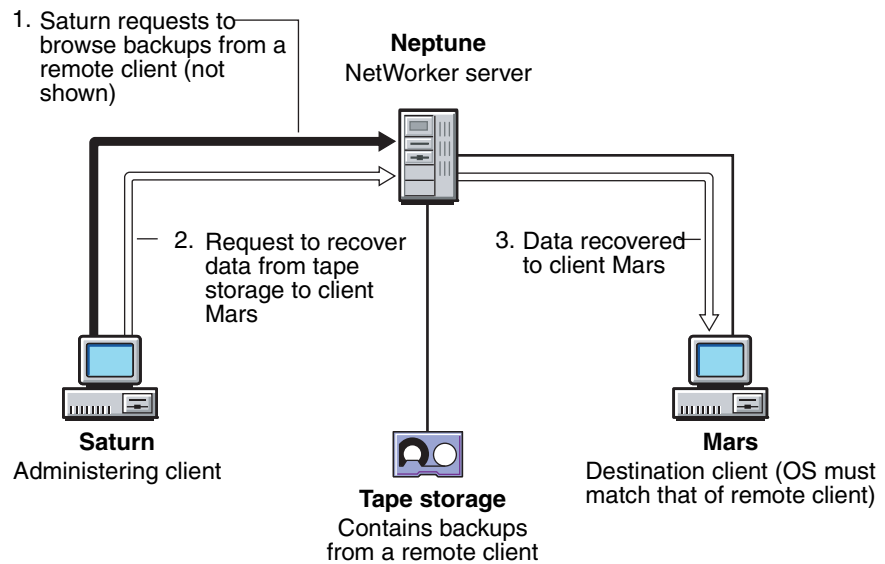

Figure 31 A directed recovery from a remote client

Note: For directed recoveries of deduplicated backups, the destination client must also have NetWorker release 7.4 with Service Pack 1 or later installed.

Uses for directed recovery

A directed recovery is particularly useful in these situations:

- ◆ When centralized administration is a requirement. All recoveries can be directed from a single administering computer.
- ◆ When recovering data to a shared server where users cannot recover the data themselves.
- ◆ When a computer is inoperable, a hard disk has crashed, or a network no longer recognizes a computer. Configure the replacement computer by recovering files from another client's backups.
- ◆ When you want to transfer files between two clients. For example, if one client's AUTOEXEC.BAT or .profile file is appropriate for a new client, recover it to the new client's hard disk.

Note: The original file ownership and permissions are always retained with directed recoveries.

Requirements for directed recovery

This section contains the requirements for directed recoveries and the procedures to enable directed recovery.

Client restrictions for directed recoveries

The destination client in a directed recovery can be any NetWorker client subject to these guidelines:

General restrictions:

- ◆ The source and destination clients must be of the same platform (UNIX-to-UNIX or Microsoft Windows-to-Microsoft Windows).
- ◆ The source and destination clients must use the same type of file system (for example, UXFS-to-UXFS, NTFS-to-NTFS).
- ◆ The administering host must be a client of the NetWorker server. The administering host is the host from which the graphical user interface is displayed.
- ◆ If the administering client is neither the source nor the destination client, it need not have the same platform and type of file system as the other clients.

Windows specific restrictions:

- ◆ For NetWorker clients running Microsoft Windows XP Professional, the NetWorker server and clients must be in a Microsoft Windows Domain, regardless of the username and password.
- ◆ For a Windows destination client, Windows File and Print Sharing must be enabled. For more information, refer to the Microsoft Windows documentation.
- ◆ Directed recovery of SYSTEM or VSS SYSTEM save sets is not supported.
- ◆ Directed recovery to a CIFS share on the destination client is not supported.
- ◆ [“Restrictions for Windows command line directed recovery” on page 335](#) provides additional restrictions.

UNIX specific restrictions

- ◆ Restrictions related to relocating non-ASCII directories on UNIX machines:
 - If the remote directory is an existing non-ASCII directory, the locale of the browsing session from which the directed recover is started must match the locale in which the remote directory was created.
 - If the remote directory does not exist, the relocation directory will be created on the remote machine’s file system based on the locale of the browsing session.

Enabling directed recoveries

Directed recovery is a restricted NetWorker function available only to users who have all privileges except for the Change security settings privilege, which is not required for directed recovery.

Note: Be selective in granting users the ability to perform directed recoveries. Directed recovery privileges enable users to browse all clients and recover data to any client.

If directed recoveries will be performed on a regular basis, establish the required permissions for each NetWorker server and client in the enterprise prior to accepting data recovery requests. “[Managing server access](#)” on page 440 provides general information about access requirements.

Access requirements to perform directed recoveries are as follows:

- ◆ Users in the Administrators group on the NetWorker server are automatically granted the necessary privileges. [Table 51 on page 332](#) provides specific access privileges that are required if a user is not a member of the NetWorker Administrators group.
- ◆ The recovery must be launched by the root user or Windows Administrator on the administering client.
- ◆ The root user or Windows Administrator on the administering client must have the Remote Access All Clients privilege on the NetWorker server.
- ◆ `SYSTEM@destination_client` must be listed in the source client’s Remote Access list.
- ◆ `SYSTEM@destination_client` must have the Recover Local Data privilege.

If the user on the destination client does not have Remote Access All Clients privileges, then the `user@destination_client` must be listed in the source client’s Remote Access list. “[Editing the servers file](#)” on page 487 provides information about editing a client.

[Table 51 on page 332](#) shows the access permissions and authorizations required to perform various combinations of directed recoveries.

Table 51 Access permissions used in directed recoveries (1 of 2)

Administering client	Source client	Destination client	Who may perform a directed recovery
UNIX	UNIX	UNIX	<ul style="list-style-type: none"> • The user must have the Remote Access All Clients privilege or the <code>user@destination_client</code> must be listed in the source client’s Remote Access list. • The <code>user@destination_client</code> must have the Recover Local Data privilege.
Windows	Windows	Windows	<ul style="list-style-type: none"> • The user must have the Remote Access All Clients privilege or the <code>user@destination_client</code> must be listed in the source client’s Remote Access list. • The <code>user@destination_client</code> must have the Recover Local Data privilege. • The <code>user@administering_client</code> must be added to the Windows Administrator Group on the administering client.
Windows	UNIX	UNIX	<ul style="list-style-type: none"> • The user must have the Remote Access All Clients privilege or the <code>user@destination_client</code> must be listed in the source client’s Remote Access list. • The <code>user@destination_client</code> must have the Recover Local Data privilege. • The recovery must be launched by a system administrator on the administering client.

Table 51 Access permissions used in directed recoveries (2 of 2)

Administering client	Source client	Destination client	Who may perform a directed recovery
UNIX	Windows	Windows	<ul style="list-style-type: none"> The user must have the Remote Access All Clients privilege or the user@destination_client must be listed in the source client's Remote Access list. The user@destination_client must have the Recover Local Data privilege. The recovery must be launched by root on the administering client.

Note: For security reasons, if a user with incorrect privileges attempts to perform a directed recovery, no error message will be issued.

Setting the Disable Directed Recover attribute

Directed recovery can be turned on or off for NetWorker clients by using the Disable Directed Recover attribute in the client's nsrla.res database. The default setting for the Disable Directed Recover attribute is No, which means that the client will accept directed recoveries from remote hosts.

To disable a remote host from directing a recovery to a client, set the **Disable Directed Recover** attribute to **Yes**.

[“Editing a client NSRLA database” on page 472](#) provides information about editing the nsrla.res database.

Adding a client computer to the remote client's servers file

[“Editing the servers file” on page 487](#) describes how to add a computer hostname to the remote NetWorker client's servers file.

Perform a directed recovery between Windows clients from the GUI

Note: Directed recovery of save sets on Windows is supported from the command line only. [“Perform a directed save set recovery by using the command line” on page 336](#) provides more information.

To perform a directed recovery:

1. Start the NetWorker User program by using the **-s** option to connect to the NetWorker server to which the source client data is backed up:

```
winworkr -s servername
```

If the **-s** option is not entered and there is only one server detected, that server will be connected to automatically. If there are no servers detected, or if there is more than one server available, the **Change Server** dialog box appears, allowing you to choose the server.

Note: Before you can perform a directed recovery of a virtual cluster client, the Client resource must be configured on the NetWorker server. [“Client configuration” on page 470](#) provides instructions on creating a Client resource. Be sure that the Client resource Remote Access attribute contains *both* of the cluster node names.

2. Click **Recover** to open the **Source Client** dialog box.

3. Select the source client, and click **OK**.
4. Select the destination client for the recovered data, and click **OK**.
5. In the **Recover** window, select the files and other items to recover.
6. Click **Start** to begin the directed recovery.

Special data handling features, such as compression, are not available for the items you select.

The selected destination client is the recipient of the recovered data. If files with the same name already exist, they are overwritten unless they have mixed-case names. Recovered files that contain mixed-case filenames do not replace newer versions of the same file that have been given a single-case filename.

Perform a directed recovery between UNIX clients from the GUI

To perform a directed file recovery:

1. Start the `nwrecover` program by using the `-s` option to connect to the NetWorker server to which the source client data is backed up:

```
nwrecover -s servername
```

The `/servers` file, located in `/nsr/res/servers`, contains entries for the NetWorker servers. If there is more than one server, the **Change Server** dialog box allows you to choose which server to connect to.

Note: Before you can perform a directed recovery of a virtual cluster client, the Client resource must be configured on the NetWorker server. "[Client configuration](#)" on page 470 provides instructions on creating a Client resource. Be sure that the Client resource Remote Access attribute contains *both* of the cluster node names.

2. Select files and other items to recover.
3. Click the **Start a recover operation** button.
4. In the **Recover Options** dialog, click **More Options**.
5. In the **Directed Recover** field, enter or select the name of the client to which the files should be recovered.
6. Click **Recover** to open the **Source Client** dialog box.
7. Click **OK**.

To perform a directed save set recovery:

1. In the `nwrecover` program, select **Recover Save Set** from the **Operation** menu.
2. From the **Name** list, select the name of the appropriate save set.
3. In the **Instances** list, select the particular version of the save set (if there are multiple versions) and click **OK**.
4. In the **Recover Options** dialog, select the relocation path in the window.
5. Click the **Recover** button.
6. Select the appropriate options in the **Recover Options** dialog box and click **OK**.

Perform a directed recovery from the command line

Use the **recover** command to perform a directed recovery from the command line. The **recover** command has a variety of options that you can add to modify the basic browse and recover functionality. [Table 52 on page 335](#) lists the options available with the **recover** command.

Table 52 Recover options

Option	Meaning
-d <i>destination</i>	Specifies the name of the directory for relocated recovered files. With this option, include a full path for destination, and use the proper syntax for the destination client's platform. The use of partial paths is not supported.
-s <i>server</i>	Specifies the name of the source client's backup server.
-c <i>client</i>	Specifies the name of the source client.
-S <i>SSID</i>	Specifies a save set to recover.
-R <i>recover_destination</i>	Specifies the name of the destination client.
-i (N,Y, R)	Specifies what the NetWorker server should do when there is a naming conflict between a recovered file and an existing file: <ul style="list-style-type: none"> • N — Skip restoring the file. • Y — Overwrite the existing file. • R — Rename the file. Each conflicted filename is appended with .R.
<i>directory_name</i>	Specifies the initial directory in which to begin browsing.

The *EMC NetWorker Command Reference Guide* or the UNIX man pages provide complete information about the **recover** command.

Example 28 The recover command

In this example, the source client's backup server is *venus*, the source client is *mars*, and the destination client is *jupiter*. All of the files in the specified directory are to be recovered. The recovered files should overwrite any existing files with the same name.

Type this command:

```
recover -s venus -c mars -R jupiter -iY directory_name
```

Restrictions for Windows command line directed recovery

In addition to the restrictions listed in [“Client restrictions for directed recoveries” on page 331](#), be aware of the following considerations when performing Windows directed recoveries from the command line.

- ◆ If the NetWorker servers and clients are running Microsoft Windows and the NetWorker server and target recover client are in the same domain:
 - Start the NetWorker server (nsrd) as a domain user that is in the Windows Administrators group on the NetWorker server machine.
- ◆ If the NetWorker servers and clients are running Microsoft Windows and the NetWorker server and target recover client are *not* in a domain, or they are *not* in the same domain, ensure that:
 - The NetWorker server (nsrd) is started as a local user that exists on both machines.

- The local user must have the same password on both machines.
- The local user must also be in the Windows Administrators group on the NetWorker server machine.
- ◆ To avoid using the Windows version of **recover.exe**, do one of the following:
 - Include `<NetWorker_install_path>\bin\recover.exe` at the command prompt.
 - Ensure that `<NetWorker_install_path>\bin` is listed before `%SystemRoot%\System32` in the `$PATH` environment variable.

Note: If a command line directed recovery fails, try to perform the directed recovery from the NetWorker User program. “[Perform a directed recovery between Windows clients from the GUI](#)” on page 333 provides details.

Perform a directed recovery of specific files and directories by using the command line

To perform a directed recovery of specific files and directories:

1. Type the **recover** command by using this syntax:

```
recover -s servername -c source_client -R destination_client -i  
recover_option [directory_name]
```

2. Navigate to the directory with the file to be selected for directed recovery. For example:

```
recover> cd /var/adm
```

3. Select a file or directory by typing this command:

```
recover> add file_name
```

4. Repeat [step 2](#) and [step 3](#) for each file or directory to be included in the directed recovery.

5. View the selected files or directory by typing this command:

```
recover> list
```

6. Start the directed recovery by typing this command:

```
recover> recover
```

- You can run the **recover** program from a Windows client to administer directed recoveries between NetWorker clients on UNIX, but only if both the source and destination clients are UNIX clients.
- You cannot recover data from UNIX clients to non-UNIX clients, or the reverse.

Perform a directed save set recovery by using the command line

Perform directed save set recover by using the following command:

```
#recover -s servername -R destination_client -iR -S SSID1 -S SSID2
```

Note: You can not recover save sets of different clients to a single client by using the same command line.

Recovering online indexes for a NetWorker server

This section includes procedures for recovering the client file index and the media database.

Recover a client file index

Client file index information is recovered by using the **nsrck** program.

To recover a client file index:

1. Log in as root or Windows Administrator and run the **nsrck** command:

```
nsrck -L5 client_name
```

The **-L5** option purges corrupted save set information from the index.

2. If the volume from which the client file index is being recovered is eligible for recycling, set the volume to read-only. This ensures that the volume will not be overwritten during the procedure:

- a. Verify whether the volume is eligible for recycling:

- To query by date:

```
mminfo -mv -c client_name -t time
```

- To query by save set ID:

```
mminfo -avot -S ssid
```

```
mminfo -mv volume_name
```

- b. If the volume is eligible for recycling, type:

```
nsrmm -o readonly volume_name
```

3. Run the **nsrck** command with the **-L7** option to recover the client file index:

```
nsrck -L7 client_name
```

To recover the client file index from a specific time, replace this step with the instructions included in [“Recovering a client file index from a specific time and date” on page 337](#).

Note: To completely remove a client file index, type **nsrck -R -Y client_name**, then type **nsrck -L7 client_name** to recover the index.

Recovering a client file index from a specific time and date

Use the **-t time date** option with **nsrck** to recover client file indexes at a specific time. The time and date formats are in **nsr_getdate** format. For details on the **nsrck** and **nsr_getdate** commands, refer to the *EMC NetWorker Command Reference Guide* or the UNIX man pages.

To recover a client file index for a specific date, type this command:

```
nsrck -t "time mm/dd/yyyy" -L7 client_name
```

Example 29 Recovering a client file index from a specific time and date

This command recovers a client file index from March 15, 2010:

```
nsrck -t "03/15/2010" -L7 client_name
```

When you recover a client file index from a time and date in the past, **nsrck** adds the full contents of the index from that time and date to a temporary subdirectory of the client file index directory. If no time value is specified, everything for the specified date (up to 23:59) will be included. After the index has been read from the backup media, the required index data is integrated fully into the client file indexes and the temporary subdirectory is removed. The “required index data” includes the indexes from the date specified to the first full backup that occurred prior to the date specified.

Be aware that if a saveset from the specified date runs into the next day, which would be March 16, 2010 in this example, then the index required to browse the saveset will not be recovered. To recover this index, you would have to specify March 16, 2010 as the recovery date as shown in the following command:

```
nsrck -t "03/16/2010" -L7 client_name
```

A check on the required index date may be necessary if index backups are set to be taken once daily. If the backup of the index does not take place until the following day, the date of the following day must be specified.

The browse policy will be reset on the recovered indexes. These index entries will be removed automatically after the new browse policy expires or they can be removed manually by using **nsrmm** after the file recovery is complete.

Restore a save set entry in the online indexes

These sections describe the process of restoring save set entries into either the client file index only, or into both the client file index and the media database.

The procedures in this section use the **scanner** command. When the **scanner** command is used to restore entries to the client file index or the media database, the entries assume the browse and retention policies of the original save set. For example, suppose a save set originally had a browse time of one month and a retention time of three months. However, the browse and retention times have expired. When you restore the save set entry by using the **scanner** program, the save set then remains browsable for one month and recoverable for three months.

Using the scanner command efficiently

In NetWorker 7.5 and higher, when a volume is marked with the scan needed flag, the user can specify the starting file and record numbers that needs to be scanned from the media database. For example:

```
scanner -f file -r record -i device
```

Use these options when a whole volume scan is not needed. This shortens the time required to run the **scanner** program. For more information, refer to the *EMC NetWorker Command Reference Guide* or the UNIX man pages.

Note: The **-i** option is not supported for cloud devices.

Restoring a save set entry to the client file index only

If a file is not browsable (which means that the save set’s browse policy has expired), but its save set is still tracked by the NetWorker server in the media database, you can make the file browsable by recovering the save set’s entry back into the client file index.

To recover the save set’s entry back into the client file index:

1. Log in as root or Windows Administrator.
2. Type the **mminfo** command at the command prompt:

```
mminfo -a -v volume_name
```

where *volume_name* is the volume that contains the client file index.
3. From the **mminfo** output, find the *ssid* that contains the required file. Make sure it is not the bootstrap *ssid*.
4. Type the **nsrmm** command with a new browse time:

```
nsrmm -S ssid -w browse_time
```

where *browse_time* is a time in the future.
5. Type the **scanner** command:

```
scanner -i -S ssid
```

The save set entry is restored to the client file index.

Restoring a save set entry to the client file index and media database

If a volume has a save set that does not appear in the media database and the save set's files are not browsable, you can restore these entries in the media database and the client file index so that the save set's files can be browsed.

To rebuild the save set's entry in the media database and the client file index:

1. Log in as root or Windows Administrator.
2. At the command prompt, run the **scanner** program on the volumes that contain the appropriate file or files:

```
scanner device_name
```
3. Use the output from the **scanner** program to determine:
 - Whether the save set to be rebuilt is on this volume.
 - Whether to reintroduce the contents of this volume into the online indexes. Locate *all* the volumes that contain this save set ID.
4. If the save set is found on multiple volumes and the order in which the volumes were written is unknown, complete this step. Otherwise, skip to [step 5](#).
 - a. On each volume that will be reintroduced into the online indexes, run this command:

```
scanner -m device_name
```

The media database is updated with information from each volume.

Note: If the volume contains data from an earlier version of NetWorker, there may be no pool information on the volume. In this case, the volume is considered to belong to the Default pool. To assign the volume to another pool, use the **-b pool_name** option in this step. If the volume already belongs to a pool, the **-b** option will have no effect.

- b. Query the media database to determine the sequence in which the volumes were written:

```
mminfo -a -v
```

In [step 5](#), the volumes must be reintroduced into the online indexes in the same order in which they were written.

5. Starting with the first volume that was written, run the **scanner** program:

```
scanner -i device_name
```

The **scanner** program prompts for a new volume until you terminate it. Scan in the remaining volumes in the order in which they were written.

6. Browse for the file to be recovered. [“Recovering by file selection” on page 317](#) provides information about browsing for a file.

Recovering the Console database

The Console database contains management data such as report information.

The *EMC NetWorker Disaster Recovery Guide* provides information about recovering a corrupted Console database.

Recovering backed-up client files from an old NetWorker server

This section describes how to move a NetWorker client to a new NetWorker server without losing the ability to recover the client files that were backed up on the old NetWorker server. To move a client to a new NetWorker server:

1. Record the **Client ID** attribute of the NetWorker client on the old server.
 - a. From the **Administration** window, click **Configuration**.
 - b. In the left pane, click **Clients**.
 - c. In the right pane, right-click the client to be renamed, then select **Properties**.
The **Properties** dialog box appears.
 - d. Click the **Globals (1 of 2)** tab.
 - e. Record the **Client ID** attribute listed for the client, then click **Cancel** to close the **Properties** dialog box.

2. On the new NetWorker server, create a new client:

- a. In the **Name** attribute, type a name for the client.

This can be the same name that was used on the old server, but it cannot be the same name as an existing client on the new server. If a client with the same name exists on the new server, use this format for the client name:

```
~hostname-#
```

where *hostname* is the hostname of the client.

For example, if the client's hostname is *jupiter*, and a client named *jupiter* already exists on the new server, type this name:

```
~jupiter-1
```

- b. Click the **Globals (1 of 2)** tab.
 - c. In the **Client ID** attribute, type the client ID determined in [step 1](#).
 - d. Complete other attributes as necessary, and click **OK**.
3. Import the client file index entries by using the **scanner** command:

```
scanner -i -c client_name device_name
```

where *client_name* is the name of the client that was set up on the old NetWorker server.

You can now recover data that was backed up when the NetWorker client was set up on the old NetWorker server.

Note: If **scanner -i** or **scanner -m** is used to import data before the Client resource is configured on the new server, the client ID for the imported save sets is maintained in the media database. If a client of the same name already exists on the new server, **scanner** stores the client name in the format described in [step 2](#). You can then create the client based on the client ID by completing that step. However, run **scanner -i** again after creating the **Client** resource to import save set information into the client file index.

Recovering the Windows system configuration

To recover a Windows client operating system configuration, recover the SYSTEM or VSS SYSTEM save sets. Recover all SYSTEM or VSS SYSTEM save sets for a client at the same time to prevent conflicts.

When All is entered in the Save Set attribute of the Client resource, these SYSTEM save sets are backed up if no VSS client license exists or VSS is disabled:

- ◆ SYSTEM STATE
- ◆ SYSTEM FILES
- ◆ SYSTEM DB
- ◆ SHAREPOINT (only if installed on the client to be backed up)
- ◆ ASR

Note: Non-VSS save sets are not supported with Microsoft Windows Vista or Windows Server 2008.

These VSS SYSTEM save sets are backed up if VSS is licensed and enabled. On Windows Vista and Windows Server 2008, VSS save sets are enabled automatically and no VSS license is required:

- ◆ VSS SYSTEM BOOT
- ◆ VSS SYSTEM FILESET
- ◆ VSS SYSTEM SERVICES
- ◆ VSS USER DATA
- ◆ VSS OTHER
- ◆ VSS ASR DISK (Windows Server 2003 only)

If VSS is licensed and enabled, at *minimum*, back up and recover VSS SYSTEM BOOT, VSS SYSTEM FILESET, VSS SYSTEM SERVICES, and all boot/system volumes to properly recover the entire system.

Note: To back up and recover SYSTEM or VSS SYSTEM save sets by using the NetWorker User program or from the command prompt, you must have local Windows Administrator privileges.

After recovery of the SYSTEM STATE, SYSTEM FILES, and SYSTEM DB save sets, reboot the operating system. Additionally, reboot the system if instructed to do so after recovery of any of the other VSS SYSTEM save sets. This ensures complete recovery of the components.

Do not attempt to restore the SYSTEM STATE or VSS SYSTEM BOOT save set twice in succession without rebooting after each operation. If you attempt to restore the VSS SYSTEM BOOT save set a second time without rebooting after the first restore, this error message will appear:

```
regsw:cannot replace Registry key. Access is denied
```

If you install a service or driver *after* a backup, then restore the backup, the newly installed service or driver may not be in the state you expect. Reinstall the service or driver, or use Control Panel to reconfigure the startup type.

Note: NetWorker software does not determine the Windows operating system version during recovery of the SYSTEM or VSS SYSTEM save sets. If you attempt to recover SYSTEM or VSS SYSTEM save sets to a different operating system, the system may be inoperable after the recovery.

For example, if you back up the SYSTEM or VSS SYSTEM save sets, then upgrade the Windows software to a new operating system. Do not recover the SYSTEM or VSS SYSTEM save sets that were backed up under the previous operating system.

Temporary disk space

Restoring the SYSTEM or VSS SYSTEM save sets requires extra disk space on the system drive for temporary files that are created during the recovery. The process might require as much extra space as the total size of the SYSTEM or VSS SYSTEM save sets.

Before restoring the SYSTEM or VSS SYSTEM save sets, run the **mminfo** command from the command prompt to check the size of the SYSTEM or VSS SYSTEM save sets to be restored:

- ◆ For NetWorker clients running a 32-bit version of Windows 2003, approximately 500MB of extra disk space is usually sufficient.
- ◆ For NetWorker clients running a 64-bit version of Windows 2003, approximately 1GB of extra disk space is usually sufficient.
- ◆ For NetWorker clients running a 32-bit or 64-bit version of Windows 2008, approximately 10GB of extra disk space is usually sufficient.

The default location for the restored system temporary files is a system drive where the original files reside. For the VSS SYSTEM save sets, the temporary files are placed in the temp directory on the system drive. For information on how to expand the available space in the temp directory by moving it to another large partition, refer to the Microsoft documentation.

When recovering SYSTEM or VSS SYSTEM save sets by using the NetWorker User program, verify that all save sets were recovered successfully. Do so by reviewing the messages in the **Recover Status** window (or the networkr log file) after the recovery is complete, but before rebooting the client computer.

Note: In Windows 2008 and Windows Vista, the BOOT / BCD (Boot Configuration Data) files that were in %systemdrive%\boot and %systemdrive%\bootmgr file are recovered to a temporary location under %systemdrive%\boot_restored-timestamp. A Windows Administrator can use these files to import BCD settings in a disaster recovery scenario.

Recovering the Windows SYSTEM from the command prompt

Before attempting to recover Windows SYSTEM components by using the commands described in this section, be aware of the following limitations:

- ◆ You cannot recover SYSTEM or VSS SYSTEM save sets by using the recover command in interactive mode. Instead, use the command line recovery procedures described in the following sections.
- ◆ You cannot perform a directed recovery of a VSS SYSTEM save set from the command prompt.
- ◆ A maximum of one SYSTEM or VSS SYSTEM save set can be included in the same **recover** command. To recover multiple SYSTEM or VSS SYSTEM save sets in one operation, use the NetWorker User program.
- ◆ File system directories cannot be specified in the **recover** command.
- ◆ A maximum of one SYSTEM or the VSS SYSTEM save set can be specified in an input file.
- ◆ File system directories cannot be specified in an input file. An input file is specified in a **recover** command with the -I option.

Examples of valid command line entries include:

```
recover -iY -s servername -N "VSS SYSTEM BOOT:"
recover -iY -s servername -N "VSS SYSTEM SERVICES:"
```

Examples of invalid command line entries include:

```
recover -iY -s servername -N "SYSTEM DB:" "SYSTEM STATE:"
recover -iY -s servername -N D:\letters "SYSTEM DB:"
```

Recover the SYSTEM save sets from the command prompt

To recover the SYSTEM save sets from the command prompt:

1. Recover the SYSTEM save sets in this order:
 - SYSTEM DB
 - SYSTEM FILES
 - SHAREPOINT
 - SYSTEM STATE

The command that is used to recover each save set should look similar to:

```
NetWorker_install_path\bin\recover.exe -iY
[-s NetWorker_server_name] -N "saveset_name"
```

2. Reboot the computer. The original SYSTEM files will be replaced by restored files.

Note: If the recovery process stops responding, terminate the process and perform the recovery operation again.

Recover the VSS SYSTEM save sets from the command prompt

To recover the VSS SYSTEM save sets from the command prompt:

1. Recover the VSS SYSTEM save sets in this order:
 - VSS SYSTEM SERVICES
 - VSS SYSTEM FILESET
 - VSS USER DATA

- VSS OTHER
- VSS SYSTEM BOOT

The command that is used to recover each save set should look similar to this:

```
NetWorker_install_path\bin\recover.exe -iY
[-s NetWorker_server_name] -N "save_set_name"
```

2. Reboot the computer. The original VSS SYSTEM files will be replaced by restored files.

Note: If the recovery fails, an error message appears. Use the Windows Event Viewer to examine the event logs for additional information. VSS recovery error messages are also written to the NetWorker log file.

Recover VSS SYSTEM save set components from the command prompt

You can recover individual components (writers) within these VSS SYSTEM save sets:

- ◆ VSS SYSTEM SERVICES
- ◆ VSS USER DATA
- ◆ VSS OTHER

Note: You cannot recover individual components of the VSS SYSTEM save sets by using the **recover** command in interactive mode. Instead, use the procedure described in this section or use the NetWorker User program.

To recover selected components:

1. Type the following at the command prompt:

```
NetWorker_install_path\bin\recover.exe -iY [-s
NetWorker_server_name] [-t browse_time] -N
"VSS_SYSTEM_SAVESET_NAME:\component_name"
```

2. Place a semicolon (;) between multiple component names.

For example, to recover the Event Log Writer writer and the WMI Writer writer, type:

```
C:\Program Files\Legato\nsr\bin\recover.exe -iY
-s jupiter -N "VSS SYSTEM SERVICES:\Event Log Writer;WMI Writer"
```

Note: Windows Server 2008 and Windows Vista do not have an event log writer. The event logs will not be backed up as part of the VSS system save sets. The event logs are backed up as part of the file system. To back up the event logs, you should perform a regular (non-VSS) backup of the system32\winevt\logs folder.

Point-in-time recovery of the SYSTEM and VSS SYSTEM save sets

To recover the SYSTEM or VSS SYSTEM save sets to a specific point in time from the command prompt, specify the ID of the save set to be restored. To browse a list of valid save set IDs:

1. From the **NetWorker Console Administration** window, click **Media**.
2. In the expanded left pane, select **Volumes**.
3. In the right pane, right-click one of the volumes listed and select **Show Save Sets**.
4. In the **SSID** column, note the appropriate save set ID.

5. Type this command on the NetWorker client host to restore the system state or system database to a particular point in time:

```
NetWorker_install_path\bin\recover.exe -iY [-s
NetWorker_server_name] -S SSID
```

where *SSID* is the save set ID that was noted in [step 4](#).

Note: If the recovery fails due to a problem with VSS or a writer, an error message appears. Use the Windows Event Viewer to examine the event logs for additional information. VSS recovery error messages are also written to the NetWorker log file.

Point-in-time recovery of Microsoft SQL Server or Exchange Server from earlier versions of NetWorker

This version of NetWorker can perform a point-in-time recovery of a Microsoft Exchange Server or Microsoft SQL Server database that was backed up with the NetWorker Client release 7.2.x.

In NetWorker release 7.3 or later, use the following EMC NetWorker modules for backup and recovery of Microsoft servers and server applications:

- ◆ **EMC NetWorker Module for Microsoft Exchange** to back up and recover the Exchange Server.
- ◆ **EMC NetWorker Module for Microsoft SQL Server** to back up and recover the SQL Server.
- ◆ **NetWorker Module for Microsoft Applications** to back up and recover Exchange Server, SQL Server, Office Sharepoint Server, and Data Protection Manager Server.

Performing a point-in-time recovery of an Exchange Server database

If VSS is licensed and enabled, a point-in-time recovery of a Microsoft Exchange Server database can be performed.

Note: These steps are not required if the NetWorker Module for Microsoft Exchange Server is being used.

To perform a point-in-time recovery of an Exchange server database:

1. Take the Microsoft Exchange Server databases offline.
2. Go into the storage group and delete all the *.log and *.chk files from the Exchange data directories.
3. Complete the recovery.
4. Bring the Exchange Server databases back online.

Performing a point-in-time recovery of a SQL Server database

If VSS is licensed and enabled, a point-in-time recovery of a Microsoft SQL Server database can be performed.

To perform a point-in-time recovery of a SQL Server Database:

1. Take the Microsoft SQL databases offline.
2. Run the NetWorker **User** program, and in the left pane of the **Recover** window expand **VSS SYSTEM SERVICES**.

3. Mark the **MSDE Writer** folder.
4. Complete the recovery.
5. Bring the SQL Server databases back online.

Preparing to recover the Windows SYSTEM STATE save set

[Table 53 on page 346](#) describes components of the SYSTEM STATE save set that require special preparation before being recovered.

Table 53 Preparing to recover the SYSTEM STATE save Set

Component	Recover preparation
Active Directory (if installed)	<ol style="list-style-type: none"> 1. When the computer is restarting, "Directory Services Restore Mode" must be specified. 2. On any domain controller that is a DNS server, ensure that the %SystemRoot%\system32\drivers\etc\hosts file includes the name and IP address of the NetWorker server. <p>The <i>EMC NetWorker Disaster Recovery Guide</i> provides complete details.</p>
Certificate Server (if installed)	<ol style="list-style-type: none"> 1. Reinstall the Certificate Server after reinstalling the operating system. 2. Specify the same name for the Certificate Server database, and the same paths for the database and log files, as when the system was backed up. 3. Copy the EFS keys. For information about EFS keys, "Encrypting file system" on page 736 provides more information.
Cluster Server (if installed)	<p>Shut down the Cluster Service on any nodes in the cluster on which the service is running , except for the node on which the recover will be performed. To shut down the cluster service, performing <i>one</i> of the following:</p> <ul style="list-style-type: none"> • Type the net stop clussvc command at the command prompt. • Use the Microsoft Computer Management program.
COM+ Database	Set the TEMP environment variable to a valid temporary directory.
SYSVOL (if installed)	None
Internet Information Server	None
Performance Counters	None

Preparing to recover the SYSTEM DB save set

[Table 54 on page 346](#) describes components of the SYSTEM DB save set that require special preparation prior to recovery.

Table 54 Preparing to recover the SYSTEM DB save set

Component	Recovery Preparation
Disk Quota Database	<ul style="list-style-type: none"> • Subsystem for drive being recovered must be created with same drive letter as the original. • Subsystem must be enabled. • Drive must be in NTFS format.
Removable Storage	Removable Storage database backup and recovery is not supported.
Terminal Services Licensing (if installed)	Terminal Services Licensing must be running.
WMI	None

Recovering Windows volume mount points

A volume mount point (or *mount point*) is a disk volume that is grafted into the namespace of a host disk volume. This allows multiple disk volumes to be linked into a single directory tree, similar to the way DFS links network shares into a unified structure.

Assigning a drive letter to a mount point is optional. Many disk volumes can be linked into a single directory tree, with a single drive letter assigned to the root of the host volume.

Recovering mount points

Perform separate recovery operations to recover the mount point and the mounted volume's data.

Note: The NetWorker Save Set Recovery feature does not support recovery of mount points. To recover mount points and their data, use these special procedures. These procedures do not apply if Automated System Recovery (ASR) is used. [Chapter 23, "Support for Windows XP and 2003 Automated System Recovery"](#) provides information about support for ASR.

Recovering a mount point and its data

To recover a Windows mount point and its data:

1. Manually create the mountpoint, if it does not exist already.
2. Start the NetWorker **User** program and recover the data under the mount point. ["Recovering by file selection" on page 317](#) provides more information about performing data recoveries.

Recovering nested mount points

To recover nested mount points and their data:

1. If the mount points do not already exist, manually create the top-level mount point, then work down the hierarchy and create each successive mount point.
2. Start the NetWorker **User** program and recover the data under the mount points.

Recovering Windows DHCP and WINS databases

If VSS is licensed and enabled, the DHCP and WINS databases are automatically included when performing a backup of save set All, Consequently, these procedures are not required.

Recover a DHCP database

To recover the DHCP database:

1. Using the NetWorker **User** program, recover the %SystemRoot%\System32\dhcp directory.
2. Using Microsoft DHCP administrative tools, restore the **DHCP** database. The Microsoft documentation provides detailed instructions about Microsoft DHCP administrative tools.

Recover a WINS database

To recover a WINS database:

1. Use the NetWorker **User** program to recover the backup configured in the WINS backup procedure. [“Backing up a WINS database” on page 84](#) provides more information.
2. Use Microsoft WINS administrative tools to restore the **WINS** database.

Note: For detailed instructions about Microsoft WINS administrative tools, refer to the Microsoft documentation.

Restoring Windows Content Index Server on Windows

The Windows Content Index Server (CIS) indexes the full textual contents and property values of files and documents stored on the local computer.

The backup and recovery of the CIS occurs as part of the SYSTEM DB save set. If VSS is enabled, the CIS is automatically regenerated upon system reboot.

Note: If you delete a nondefault CIS database and then try to restore it, the restored database cannot be active until the registry is restored as part of a SYSTEM STATE save set recovery.

During a CIS restore:

- ◆ If you are using the CIS in a program that provides search capability (for example, a website), the search functionality will not be available.
- ◆ Queries can be issued, but response time might be slow.

After a restore, the CIS automatically updates the catalogs to reflect the current data. Therefore, if it has been a long time since the last backup, it may be more efficient to rebuild the catalog than to restore it. However, if the catalog is very large, restoring it might be faster than rebuilding it.

Note: After a restore, all catalog directories automatically restart, even if they were stopped at the time of the backup.

If a restore of the CIS fails, rebuild the CIS:

1. Right-click **My Computer** and select **Manage** to open the **Computer Management** console.
2. Expand **Services and Applications**.
3. Right-click the catalog to be rebuilt and select **All Tasks>Empty Catalog**.
4. Manually stop the CIS and restore the CIS again.
5. Restart the CIS.

When you restart the service, the CIS re-indexes the entire catalog.

Restoring BOOT/BCD Data on Windows 2008 R2 and Windows 7

In Windows 7 and Windows 2008 R2, the BCD store contains the boot configuration parameters and controls the computer's boot environment.

BCDEdit is a command-line tool provided by Microsoft to add, delete, edit, and modify data in a BCD store.

During recovery, the BCD file is recovered to the folder C:\boot_restored-{timestamp}. To restore the recovered file, import the file by using the following command:

```
bcdedit /import c:\boot_restored-{timestamp}\BCD
```

Note: Restoring the recovered file is optional.

This chapter covers these topics:

◆ Gathering report data	352
◆ Data retention and expiration policies	353
◆ Setting expiration policies for data retention	354
◆ Running a jobquery	354
◆ Report categories	355
◆ Report types	356
◆ Configuring reports	357
◆ Viewing reports	360
◆ Preconfigured reports	366
◆ Customizing and saving reports	381
◆ Sharing reports	383
◆ Exporting reports	384
◆ Command line reporting	385
◆ Printing reports	386

Gathering report data

To facilitate trend analysis, capacity planning, and problem detection, NetWorker software automatically collects data on a continual basis from the NetWorker enterprise. NetWorker Console stores the collected information in the Console database for a specified number of days, as described in [“Data retention and expiration policies” on page 353](#).

NetWorker software then integrates and processes this data to produce a number of reports on backup status, backup statistics, events, inactive files, hosts, users, and devices. [“Report categories” on page 355](#) provides detailed information about the various types of reports.

The following options are available through the NetWorker Console reporting feature:

- ◆ Data collection for the entire enterprise or for specific NetWorker servers.
- ◆ Creating of various types of reports.
- ◆ User preferences for report data, such as font, size, and whether or not to use bold. This can be useful in I18N environments.
- ◆ Selection of columns to display when viewing reports in a table format, and the order in which to display them.
- ◆ The ability to save customized reports for repeated use.
- ◆ The ability to determine how long collected data should be retained.
Only NetWorker administrators can modify these time periods.
- ◆ The ability to share reports, or restrict the sharing of reports, with other users by giving them access to the reports.
- ◆ The ability to hide shared reports of other users when listing reports.
- ◆ The ability to run reports from the command prompt.

Note: The NetWorker Console is unable to generate reports when deployed in a pure IPv6 environment due to a Sybase iAnywhere 9 limitation.

Enabling/Disabling the gathering of report data

The Gather Reporting Data feature is set by default when a host is added to the enterprise. If the NetWorker server to be monitored is not yet in the enterprise, you can enable the Gather Reporting Data feature when adding the NetWorker server to the enterprise. [“Adding a managed host” on page 428](#) provides details.

To enable or disable the gathering of report data:

1. From the **Console** window, click **Enterprise**.
2. Select the **NetWorker** server for which the collection of report information is to be enabled.
3. Right-click the NetWorker managed application, then select **Properties**. The **Managed Application Properties** dialog box appears.
4. Under **Features**, select **Gather Reporting Data**, then click **OK**.

To disable the gathering of reporting data, clear the **Gather Reporting Data** checkbox, then click **OK**.

Data retention and expiration policies

NetWorker Console provides separate expiration policies for retaining different types of data, in the NetWorker Console database, to meet the needs of the environment as described in [Table 55 on page 353](#). Only a Console Application Administrator can modify these policies.

Table 55 Data retention policies

Retention policy	Type of data to be retained	Default
Completion Data (in Backup Status reports, <i>except</i> in the save set output). Retention policy for completion data can affect multiple reports.	Savegroup and save set completion data and drive data.	One month
Completion Message (in Backup Status reports, <i>only</i> in the save set output). Retention policy for completion messages can affect multiple reports.	Messages, such as error messages for failed save sets.	Two weeks
Save Set Data (in all Backup Statistics reports). Retention policy for save set data can affect multiple reports.	Save set records.	One year
Audit Data (in User Audit reports). Retention policy for audit data affects only audit reports.	Reports on all NetWorker tasks (except License Manager tasks) performed by specified users (but only when the NetWorker User Auditing system option is activated).	One year
Recover Statistics Save Set Data in Recover Statistics reports.	Save set records.	One year

You can view the retention policies for data to which they have access by following the first three steps in [“Setting expiration policies for data retention” on page 354](#). These different policies give administrators the flexibility to retain certain types of information for less time than others, as demonstrated in [Example 30 on page 353](#).

Note: Reports not mentioned in [Table 55 on page 353](#) have no retention policies.

Example 30 Retention flexibility

An administrator might want to set the completion message policy to a shorter period than the completion data policy. The precise error messages about what caused a save set backup to stop might not be relevant over a longer time period. But it might be useful to save the completion data for a somewhat longer period to help with load balancing and trends.

The longest time period (one or more years) might be a suitable selection for save set data. This data is used to generate the NetWorker Backup Statistics reports. These reports can be used to determine historical trends about backups and to help guide capacity planning.

Note: The expiration policies restrict the data that can be retrieved by NetWorker Console. In other words, reports cannot include data that is older than the data retention policy. Once data is purged because of the retention policy, it *cannot* be retrieved except by recovering the full database.

If, for example, an administrator changed a policy expiration period from 1 year to 1 month and soon afterwards reset it to 1 year, 11 months of data would be lost.

Setting expiration policies for data retention

Note: Only a Console Application Administrator can perform this procedure.

To set expiration policies:

1. From the **Console** window, click **Reports**.
2. From the **Reports** menu, select **Data Retention**. The **Data Retention** dialog box appears.
3. For each policy, type the number of periods and select a period of time (year, month, week, day).
4. To save the configuration of the data retention policies, click **OK**.

Note: There must be adequate space in the Console database to hold the data. If the data retention policy settings cause the Console database to run out of storage space, it stops running. The *NetWorker Installation Guide* provides information about estimating the size of the Console database .

Running a jobquery

The **jobquery** command is a command that can be used to view jobs by type and by status. A query is defined by an attribute list that is made of one or more attribute names with or without values.

In the query, the attribute name (for example, 'type') is preceded by a '.', and optionally followed by a ':' and a comma-separated list of values (for example, "host: mars"; "job state: STARTED, ACTIVE, SESSION ACTIVE"). When a query consists of more than one attribute names, attributes are separated by a ';'. When an attribute name is specified without values, any resource descriptor that contains this attribute is a match. If an attribute name is followed by one or more values, a resource whose value list matches at least one of the values for the specified attribute satisfies the criteria.

Running **jobquery -s <server>** will connect to specified server and return a prompt where you can then run a query with the following commands:

- ◆ **types** — a command that lists all job types currently known by **nsrjobd** that does not take any argument (for example, **types** will return a list indicating **Known types: save job, savegroup job**, and so on).
- ◆ **.** — a command that sets the query criteria and is followed by one or more attribute names, or lists current query criteria when not followed by any attribute.

Query criteria may contain several attributes, including job type, host, and job state, with each attribute separated by a semi-colon and each value separated by a comma, as in the following example:

```
jobquery> . type: savegroup job; host: mars; job state: ACTIVE,
COMPLETED
```

The above example would return information on all savegroup jobs from the machine mars that are either in progress or in completed state.

- ◆ **show** — restricts the list of attributes returned for each resource descriptor that matches the query. For the above example, specifying the following:

```
show name; job id; completion status; completion severity
```

will return the names, job ids, completion status and completion severity for all matched completed and active savegroups.

- ◆ **print** — executes the query and displays the results. If show list is in effect, each resource descriptor in the result list is restricted to desired attributes.
- ◆ **all** — returns all resource descriptors in the jobs database. If show list is in effect, result is restricted to desired attributes.
- ◆ **help** — displays help text.
- ◆ **quit** — exits jobquery.

Note: If no server is specified, **jobquery** attempts to connect to **nsrjobd** on the local host. If there is no **nsrjobd** running on the specified server or the local host, an error is returned.

Running **jobquery -i <input file>** reads input from the file for non-interactive usage.

Report categories

[Table 56 on page 355](#) describes the various report categories included in NetWorker software. Each of these categories is discussed in detail in [“Preconfigured reports” on page 366](#).

Report categories appear as folders within the Reports window. These reports can be run either from the Console window or from the command prompt.

Table 56 Report categories(1 of 2)

Category of report	Purpose
NetWorker Backup Statistics	Provide statistical information about save sets from the media database. Include summaries of size, number of files, and number of save sets backed up. “NetWorker backup statistics reports” on page 367 provides more information.
NetWorker Backup Status	Provide status information about savegroup completion and save set backups. “NetWorker backup status reports” on page 368 provides more information.
Clones	Provides the history of automatic and scheduled clone operations performed on NetWorker servers on version 7.6 Service Pack 2 and later. “NetWorker clone reports” on page 370 provides more information.
Events	Provide summary and detailed information about NetWorker events. “Event reports” on page 376 provides more information.
Hosts	Provide a listing of NetWorker servers in the Enterprise, including information about event and reporting features. “Host reports” on page 378 provides more information.
Users	Provide lists of defined NetWorker Console users, logout and login reports, audit reports, and users with restricted views. “User reports” on page 378 provides more information.
Devices	Provide information about the way devices are being used. “Device reports” on page 378 provides more information.
Inactive Files	Manages inactive files on a client or group and sets the NetWorker software to automatically generate a list of inactive files in an environment. “Inactive files report” on page 380 provides more information.

Table 56 Report categories(2 of 2)





Category of report	Purpose
NetWorker Recover	Provide the history of recovery operations that have been performed by NetWorker servers. “NetWorker recovery reports” on page 372 provides detailed information about the reports in this category.
Avamar Statistics	Provide deduplication backup statistics for each selected NetWorker client. “Avamar Statistics reports” on page 374 provides more information.
Cloud Backup and Recover	Provide information on the Cloud usage for scheduled backups and recovers that are performed by the NetWorker server to and from the Cloud storage device. “Cloud backup and recover reports” on page 379 provides more information.
Data Domain Statistics	Provides deduplication backup statistics for each selected NetWorker client. <i>NetWorker Data Domain Deduplication Devices Integration Guide</i> provides more information.

Report types

All of the reports are listed within the report category folders. These folders are seen in the left pane of the Reports window. Each folder contains basic and drill-down reports. [“Basic reports” on page 356](#) and [“Drill-down reports” on page 357](#) provide detailed information.

Different icons represent the different types of reports:

Table 57 Report icons

Icon	Description
	Basic report
	Shared basic report
	Drill-down report
	Shared drill-down report

Basic reports

The basic reports organize the collected data in a manner that focuses on a specific datazone component, time span, or attribute. For example:

- ◆ A Server Summary of Backup Statistics provides backup statistics in a server-centric manner.
- ◆ A Monthly Summary of Backup Statistics provides the backup statistics in a date-centric manner.
- ◆ A Priority Summary of Events provides a report in an attribute-centric manner.

Select the basic report that best provides the information you need.

Drill-down reports

Drill-down reports are preset sequences of basic reports, and can be saved as customized reports in shared mode.

Move up and down through a sequence to compare the information provided by the different focal points. For example, from the NetWorker Backup Status category, it is possible to select the Group Status by a Server drill-down report. This report starts at the server level, then drills down to display a summary report for each of the following:

- ◆ A selected group
- ◆ A selected monthly summary
- ◆ A selected daily summary

Note: In “document mode” for drill-down reports, the print and export commands do not print or export the entire drill-down report, just the basic report that is currently displayed. Also note that drill-down reports cannot be run from the command prompt.

Customized reports

A report that is included with NetWorker software is known as a “canned report” and includes several configuration parameters that allow the tailoring of report data. With customized reports, report versions can be configured—a single time—to fit the needs of the enterprise, and then saved and rerun whenever necessary, without having to be configured again. This saves time, especially with regularly run reports that include complex combinations of parameters. Customized reports can be run either on demand, or according to a preset schedule. The owner of a saved report can also allow it to be shared with all users.

The Hide Other Users Reports option toggles the view of reports between:

- ◆ The owner’s reports (private and shared)
- ◆ The owner’s reports, plus all shared custom reports

“Customizing and saving reports” on page 381 and “Sharing reports” on page 383 provide more information.

Configuring reports

Each type of report includes its own configuration parameters that act as filters limiting the data used to build the report output. By default, these parameters are set to include all the information available in the report, which means that the filters are turned off to begin with.

For example, the NetWorker Backup Statistics Server Summary report includes these configuration parameters:

- ◆ Server name
- ◆ Backup type
- ◆ Backup level
- ◆ Save time

In this example, accepting the default configuration of selected parameters results in a report that includes backup statistics for all the servers in the enterprise. The statistics reported for each server would include all backup types and levels, and the time range would include all the data available.

Note: For Drive Utilization reports, the time range cannot exceed eight days. [“Date and time formats” on page 358](#) provide more information about this limitation, or for details on how to set this range.

The scope of a report can be limited by filtering out one or more parameter options, for example:

- ◆ To exclude certain servers in the enterprise from the report, remove selected server names from the Server Name Selected box.
- ◆ To select only full backups, remove the other backup types from the Server Name Selected box.
- ◆ To include only the statistics for the past month, specify that time range. Time ranges are localized. The input format follows the format specified in locale settings of the operating system.

When a parameter is removed from the Server Name Selected box, it goes into the Server Name Available box. To include that parameter again, click **Add (➤)**.

How to configure a report

To configure a report:

1. From the **Console** window, click **Reports**.
2. Expand a report category folder, then select an available report type.
 - When a report type has been selected, the **Configure** tab for that report appears in.
 - The possible parameters for that report appear by default in the **Selected** boxes.
3. To limit the scope of the report, click any of the parameters in the **Selected** box, then click **Remove (◀)**.
 - To remove all of the parameters from the **Selected** box, click **Remove All (◀◀)**.
 - Removed parameters appear in the **Available** boxes.
4. To return:
 - A single parameter to the **Selected** box, select it from the **Available** box and click **Add (➤)**.
 - All available parameters to the **Selected** box, click **Add All (➤➤)**.
5. To display the report, select the **View Report** tab.

Date and time formats

If a report includes a date-and-time-range parameter, specify the beginning and end date and time in the To and From text boxes. Clicking the arrow of a time input field displays a calendar and clock selector, including adjustment arrows for setting values.

In US English locales, the default “From” hour is 12:00:00 (midnight/morning) on the “From” date, and the default “To” hour is 11:59:59 (night) on the “To” date. The US English locale is the only one that includes a box for an A.M. or P.M. value.

In non-US English locales, the default “From” hour is 00:00:00 (midnight/morning) on the “From” date, and the default “To” hour is 23:59:59 (night) on the “To” date.

The option of displaying times in 12- or 24-hour formats is determined by the Regional and Language Settings on the system.

Input formats

Date and time input formats in the NetWorker software vary. Some acceptable input formats for a collection of common locales are shown in [Table 58 on page 359](#).

Table 58 Date and time input formats for common locales

Language	Date formats	Time formats
US English	<ul style="list-style-type: none"> EEEE, MMMM D, YYYY (Monday, March 8, 2009) MMMM D, YYYY (March 8, 2009) MMM D, YYYY (Mar 8, 2009) M/D/YY (3/8/07) 	<ul style="list-style-type: none"> h:mm:ss a z (11:27:30 P.M. PST) h:mm:ss a (11:27:30 P.M.) h:mm a (11:27 A.M.)
UK English	<ul style="list-style-type: none"> DD MMMM YYYY 08 March 2009 DD-MMM-YYYY (08-Mar-2009) DD/MM/YY (08/03/07) 	<ul style="list-style-type: none"> HH:mm:ss z (23:27:30 PST) HH:mm:ss (23:27:30) HH:mm (23:27)
French	<ul style="list-style-type: none"> EEEE D MMMM YYYY (lundi 8 mars 2009) D MMMM YYYY (8 mars 2009) D MMM YYYY (8 mar. 2009) DD/MM/YY (08/03/07) 	<ul style="list-style-type: none"> HH:mm:ss z (23:27:30 PST) HH:mm:ss (23:27:30) HH:mm (23:27)
German	<ul style="list-style-type: none"> EEEE, D. MMMM YYYY (Montag, 8. März 2009) D. MMMM YYYY (8. März 2009) DD.MM.YYYY (08.03.2009DD) MM.YY (08.03.07) 	<ul style="list-style-type: none"> HH:mm:ss z (23:27:30 PST) HH:mm:ss (23:27:30) HH:mm (23:27)
Japanese	<ul style="list-style-type: none"> YYYY/MM/DD (2009/03/08) YY/MM/DD (07/03/08) 	<ul style="list-style-type: none"> HH:mm:ss z (23:27:30 JST) HH:mm:ss (23:27:30) HH:mm (23:27)
Simplified Chinese	<ul style="list-style-type: none"> YYYY-M-D (2009-3-8) YY-M-D (07-03-8) 	<ul style="list-style-type: none"> HH:mm:ss (23:27:30)

In [Table 58 on page 359](#), note that:

- ◆ Formats shown as single digits (M, D, h) may also be entered as double digits. For example, M could be either 7 or 07 for the seventh month.
- ◆ In the time-formats column:
 - The **a** character denotes a 12-hour format.
 - The absence of an **a** character denotes a 24-hour format.
 - The **z** character indicates time zone. If the **z** is present, then the output time will contain a time zone.

Relative times can also be entered in the From and To fields. A valid relative time consists of an number followed by a unit of time, for example, *2 months*. Time units can include Hour, Day, Week, Month, and Year.

Remember that these reports are run by using dates that have already occurred. Consequently, even the *To* date is always a past date. The relative time *4 months* would provide report data covering the past 4 months. A report specifying *from 9 months to 1 month* includes data from nine months ago up to one month ago.

Note: For Drive Utilization reports, the time range cannot exceed 8 days. That is, the date entered in the *To* field cannot exceed 8 days from the date entered in the *From* field. If typing a relative time in the *To* field, the value cannot exceed 8 days.

Viewing reports

Before displaying a report, select the scope of the report by specifying Configuration parameters. [“How to configure a report” on page 358](#) provides information on configuring reports.

In addition, reports can be printed or exported to various file formats. [“Printing reports” on page 386](#) and [“Exporting reports” on page 384](#) provide information about printing and exporting.

The administrative user can restrict a user’s view of the enterprise to certain servers, affecting the user’s view and scope of his or her reporting.

View reports

To view reports:

1. From **Console** window, click **Reports**.
2. Select a report type.
3. To limit the scope of the report, specify parameters on the **Configuration** tab.
4. Click the **View Report** tab. Most reports display initially in interactive mode and table format.
5. To modify the current view, right-click on the **View Report** tab and select the appropriate view option.

Reports can be displayed in either interactive or document mode. Depending on the report, you may also select to display the content of the report as a table or as a chart. NetWorker supports the following report modes:

- ◆ [“Interactive mode” on page 360](#)
- ◆ [“Document mode” on page 362](#)
- ◆ [“Interactive and document mode chart types” on page 363](#)

In addition, NetWorker includes these restrictions and processing considerations:

- ◆ [“Restricting report views” on page 366](#)
- ◆ [“Background processing of reports” on page 366](#)

Interactive mode

Interactive mode displays a report with dynamic components. The effect of the dynamic components depends on whether a report is viewed as a table or as a chart.

Interactive mode allows access to drill-down reports. Drill-down reports conveniently group related reports to make it easier to view increasing levels of granularity in report data.

Interactive Mode also offers a set of chart selection choices. These choices limit the data in a report by including or excluding certain parameters. Examples of chart-selection parameters include:

- ◆ Duration
- ◆ Save set size
- ◆ Number of files
- ◆ Amount of data
- ◆ Number of save sets

Not all parameters apply to each chart type.

Interactive mode table view

In the table view of the interactive mode, you can:

- ◆ Scroll through rows of the table.
- ◆ Sort, rearrange, or resize columns in the table.
- ◆ Choose which columns to display, and the order in which to display them.

Note: In interactive mode, tables can be sorted just as they can be sorted within other Console windows.

Interactive mode chart view

When a chart is displayed in interactive mode, you can:

- ◆ Switch back and forth between different chart formats by selecting a format from the Chart Type list.

A simplified list of chart formats is provided in [Table 59 on page 363](#).

Note: When viewing a Drive Utilization report as a chart, it automatically displays as a Gantt chart. The chart type cannot be changed.

- ◆ Change selections by using the Data Selector, where applicable.

The Data Selector is available in select reports, and includes control-column information that works in conjunction with a graph of numerical data. While the Data Selector is useful in table format, it can also be used to display interesting and useful data groupings in chart format.

For example, in a Group Summary by Server report displayed in Bar Chart format, the bar chart displays the amount of data in each group, and the Data Selector lists the "Server" control column, making it possible to see—in one place—a summary of groups across all servers, simply by moving through the list of servers in the Data Selector. This could be useful for finding the group that backed up the most data, or for balancing groups on servers.

- ◆ Limit the set of X and Y axes in the report by clearing one or more options from the Chart Selector checkboxes. This does not apply to Drive Utilization reports.
- ◆ For Drive Utilization reports, hover over a chart in Save Set view or Drive view to display a tool tip that includes this information:
 - Drive (Drive view only)

- Save Set Name (Save Set view only)
- Start Time
- End Time
- Client Name
- Throughput (B/Sec)

Note: The tool tip feature for Drive Utilization reports is available only in Interactive mode.

Document mode

Document mode displays a static report that resembles the view in Print Preview as shown by a PDF file viewer. Within Document mode, these options are available:

- ◆ Orientation (portrait or landscape)
- ◆ Table or chart format
- ◆ Size (zoom level)

Note: In Document mode, for any chart type that displays X-Y axes, two graphs are displayed. If the top graph contains excessive Y-axis data, the data displayed in both graphs could be truncated.

In Document mode, the columns of a tabular report cannot be sorted, rearranged, or resized. In addition, you cannot choose which columns to display, and the order in which to display them. Likewise, the chart format cannot be modified while viewing a report. NetWorker software does not maintain any customized changes made while displaying a report in interactive mode (such as sorting or rearranging the columns in a table), except for charts (in Chart Type and Chart Selector). Instead, document mode displays the report in a standard table or chart format, as specified by the internal report definition within NetWorker software.

Unlike Interactive Mode, which offers a set of parameters for chart selection that limit the data that is displayed, a report in Document mode displays all of the data. As a result, report views in Document mode often consist of several screens. For this reason, the viewing choices in Document mode include these options for paging through the output:

- ◆ First
- ◆ Previous
- ◆ Next
- ◆ Last

Document mode table view

Document-mode reports displayed as a table contain several columns of information:

- ◆ One or more *control* columns represent report information that *cannot* be summed as quantitative data (for example, Server name, Save set name, Backup type, and so on). The control columns topics are generally shown as X-axis data in charts.
- ◆ One or more *data* columns represent report information that can be summed as quantitative data (for example, Amount of data, number of files, number of save sets, and duration). The data columns topics are generally shown as Y-axis data in charts.

The bottom line of each report gives subtotals and totals of all the columns of quantitative data shown in the report.

For example, a report on Save Set Details by Client:

- ◆ Lists each client.
- ◆ Provides:
 - Subtotals of the data columns for each of that client's save sets.
 - Totals of all the data columns for each client.
 - Totals of the data for all clients in the report.

This makes it easy to parse the data, visually, on a per-client basis, on a save set-per-client basis, and for all clients in the report.

Interactive and document mode chart types

These chart types are available in both interactive and document mode:

- ◆ Bar chart
- ◆ Pie chart
- ◆ Plot chart
- ◆ Stacking bar chart
- ◆ Gantt chart (for Drive Utilization reports only -- more information is provided in the section [“Types of Device reports and configuration”](#) on page 378).

Note: When displaying reports in chart format, the size and appearance of the chart may differ depending on the orientation (portrait or landscape) and the presentation format—that is, whether viewing it in the Console window, or in other file formats, such as PDF, HTML, or PostScript. When displaying reports as charts in document mode, or when printing or exporting to HTML or PostScript, the charts are always displayed on a single page, regardless of their size. As a result, some data and labels may not display. To see full report details, view the chart in interactive mode.

[Table 59 on page 363](#) shows a simplified version of chart format options.

Table 59 Report chart formats(1 of 2)





Format	Example
Bar	
Plot	

Table 59 Report chart formats(2 of 2)

Format	Example
Pie	
Stacking Bar	
Gantt	

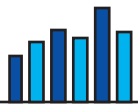
Bar chart

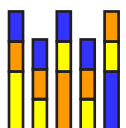
A bar chart uses bars to illustrate the different types of data. For example, in a bar chart of a NetWorker Backup Statistics Server Summary report, the vertical bars show the amount of data backed up by each server. The additional lines show the corresponding numbers of files and save sets backed up by each server.

The set of axes displayed in the report depends on the type of report.

To select various elements for display, select or clear the appropriate checkboxes in the Chart Selector.

Plot chart

Plot charts display data graphed as points along X and Y axes.

To select various elements for display, select or clear the appropriate checkboxes in the Chart Selector.

Pie chart

Pie charts display data graphically as a percentage of a circular “pie.” When specifying this chart type from the Console window, the Chart Selector includes a radio button that allows the display of only one element, or axis, at a time. If an additional element is selected, it replaces the first. This limitation does not occur when this chart type is specified from the command prompt:

- ◆ When this chart type is selected from the Console window, all applicable data axes are shown.
- ◆ When this chart type is specified from the command prompt, only the requested information is included.

Stacking bar chart

The stacking bar charts are most appropriate for reports where the data is grouped and measured according to more than one category. For example, use of a stacking bar chart to display a report that measures data according to only a single point of focus would display just a simple bar chart. Stacking bar chart reports generally include *by* in the name, such as *by date* or *by host*.

In Interactive mode, movement of the cursor over a section of stacked color causes a pop-up legend to appear. The legend describes the data represented by that color. This chart type is inappropriate for complicated data in Document mode, since the cursor does not display a legend describing the data represented by that color. Instead, in Document mode, select a different chart type (bar, pie, or plot) if the report data is complicated.

When specifying this chart type from the Console window, the Chart Selector includes a radio button that enables the display of only one element, or axis, at a time. If an additional element is selected, it replaces the first. This limitation does not occur when this chart type is specified from the command prompt.

- ◆ When this chart type is specified from the Console window, all applicable data axes are shown.
- ◆ When this chart type is specified from the command prompt, only the requested information is shown.

[Example 31 on page 365](#) describes appropriate use of the stacking bar chart type.

Example 31 Appropriate usage of the stacking bar chart

To appreciate the different ways in which a stacking bar chart may be used, consider these reports:

- ◆ A NetWorker Backup Statistics Group Summary by Server shows statistics broken down by savegroup for each server. Different blocks of color are used for the amounts of data backed up by each savegroup within the vertical bars that represent the amount of data that are backed up by servers.
- ◆ A NetWorker Backup Statistics Server Summary shows data from only one focus, a server-centric point of view. If a stacking bar chart is selected to display a NetWorker Backup Statistics Server Summary, the chart would display solid bars of color to represent the servers. There would, however, be no blocks of color within the bars, because the report focuses only on the server level. The result would therefore look like a simple bar chart.

Gantt chart

When viewing a Drive Utilization report as a chart, it automatically displays as a Gantt chart, and the chart type cannot be changed. The Drive Utilization report is the only report that displays as a Gantt chart.

In Save Set view, the X axis displays the time, and the Y axis displays save set data. Hovering over the chart in Save Set view displays a tool tip that provides this information:

- ◆ Save set name
- ◆ Start time
- ◆ End time
- ◆ Client name
- ◆ Throughput value

In Drive view, the X axis displays the time, and the Y axis displays drive data. Hovering over the chart in Drive View displays a tool tip that provides this information:

- ◆ Drive
- ◆ Start time

- ◆ End time
- ◆ Throughput value

Chart axis selection

Document mode can display more than one chart in the document. Any or all available Y axes can be inserted into the report. When a user changes to document mode, prints or exports a report, or saves a configuration, the axis selection currently set in the Chart Selector section of the Configuration tab is used.

The exceptions to this are stacked bar and pie charts, which display all axes when the `gstclreport` command is used to generate a report.

Restricting report views

When a NetWorker Console user is added or reconfigured, the user's views of NetWorker servers, groups, and clients within the enterprise determines the content of reports that he or she can produce.

Since each user can have different access restrictions, the view of each report can potentially be different. This applies to all report types, whether customized, private, or shared.

For example, a shared backup summary report entitled "Building C Backups" will show different data for different users if the users' access permissions include different NetWorker servers. This is so even if the reports are run at the same time.

In the Reports function, report parameters for a specific user display only the allowed NetWorker servers, groups, and clients as sources of report information. The resulting reports contain data only from those servers. A user may only run reports for servers he or she is allowed to manage.

Note: If no data is available for a given server, that server will not appear in any lists, regardless of the user's view or access.

Background processing of reports

When the **View Report** tab is selected, the report data is removed from the server. This process happens in the background and could take awhile. Other portions of the interface are usable while the report data is being processed. The requested report appears upon returning to the **View** tab.

Note: Do not request multiple reports at the same time. Since reports are run sequentially in the background, a user can navigate around in the user interface while a report is running. If a new report is started before an earlier report is finished, then the earlier report is terminated and deleted. A report is either complete or deleted, the results are never partial.

Preconfigured reports

To facilitate the dissemination of information, NetWorker software includes a variety of reports:

- ◆ ["NetWorker backup statistics reports" on page 367](#)
- ◆ ["NetWorker backup status reports" on page 368](#)
- ◆ ["NetWorker clone reports" on page 370](#)
- ◆ ["NetWorker recovery reports" on page 372](#)

- ◆ “Data Domain statistics reports” on page 374
- ◆ “Avamar Statistics reports” on page 374
- ◆ “Event reports” on page 376
- ◆ “Host reports” on page 378
- ◆ “User reports” on page 378
- ◆ “Device reports” on page 378
- ◆ “Cloud backup and recover reports” on page 379
- ◆ “Inactive files report” on page 380

NetWorker backup statistics reports

The different types of reports included within the NetWorker Backup Statistics report category provide backup statistics for each selected NetWorker server within the enterprise.

NetWorker Backup Statistics reports may include this information:

- ◆ Amount of data backed up.
- ◆ Number of files backed up.
- ◆ Number of save sets backed up.

Types of NetWorker backup statistics reports and configuration

The NetWorker Backup Statistics report category includes basic and drill-down reports.

The Configure tab allows you to limit the scope of the report that was selected.

The parameters available within the NetWorker Backup Statistics report category are described in [Table 60 on page 367](#). The specific parameters available depend on which NetWorker Backup Statistics report is selected.

Table 60 NetWorker backup statistics parameters

Parameter	Description	Options
Server Name	Selects managed hosts within the enterprise.	Selected server names
Group Name	Selects one or more groups.	Selected group names
Client Name	Selects one or more clients.	Selected client names
Save Set Name	Selects one or more save sets.	Selected save set names
Backup Type	Selects one or more file types.	List of supported file types
Level	Select one or more backup levels.	List of backup levels such as, Full, Incremental, Skip, or Level 1-9
Save Time	Limits the report to a specified time range. The default range is one day for save set details reports. Note: The date/time format available depends on the language locale of the operating system.	Save time (range)

The parameters available for each report type in the NetWorker Backup Statistics report category are listed in the user interface.

Save set data retention policy and configuration

Settings for the save set retention policy impact the data that is available to the NetWorker Backup Statistics reports. If a save set retention policy of 6 months is specified, NetWorker software cannot query the database for a time range that extends back more than 6 months. The report cannot display data that has expired because that data has been removed from the database. Thus, even if a save time parameter of one year is specified, the report can display only six months of data if the limit of the save set retention policy is six months.

Backup statistics basic reports

Within the NetWorker Backup Statistics report category, choose any of the basic reports listed in the user interface. Once a report is chosen, the Configuration tab displays boxes with lists of the selected parameters for that report. To exclude unwanted parameters from the report, delete them from the list. [“How to configure a report” on page 358](#) provides information on selecting and removing parameters .

Except for the Avamar Backup Summary report, these basic reports do not distinguish between regular and deduplication clients.

Backup statistics drill-down reports

The drill-down reports consist of multiple NetWorker Backup Statistics basic reports, connected in a predetermined sequence. [“Drill-down reports” on page 357](#) provides general information about drill-down reports.

The configuration parameters for a drill-down report are the same as the parameters for the top-level report in the report sequence. Thus, if the top layer of the drill-down report is a Monthly Summary report, the configuration parameters are the same as they would be for the basic report, Monthly Summary.

When a report is chosen, the Configuration tab displays boxes that list the selected parameters for the top-level report. To exclude unwanted parameters from the report, delete them from the list. [“How to configure a report” on page 358](#) provides information on selecting and removing parameters.

NetWorker backup status reports

The NetWorker Backup Status reports consolidate information about the success of scheduled group backups. As with the NetWorker Backup Statistics reports, these reports can provide either an enterprise-wide or a more focused summary of activity over a specified time range.

The NetWorker Backup Status reports provide the same basic function as selecting Show Details for a group in the Monitoring window of the Administration window. The NetWorker Backup Status reports, however, allow you to select the scope and level of detail.

Note: The report calculates the amount of time taken by each backup group individually. Consequently, if several groups run in parallel, their total combined backup time is greater than the time elapsed between the start of the first group and the completion of the last group. For example:

- Group A starts at 13:00 and completes at 15:00.
- Group B starts at 13:30 and completes at 15:30.
- Although the groups both completed within a 2.5-hour period, the total group runtime is counted as 4 hours.

NetWorker Backup Status reports can include this information:

- ◆ Total group runs
- ◆ Totals of successful, failed, and interrupted group runs
- ◆ Success ratio
- ◆ Backup duration
- ◆ Backup level
- ◆ Backup type
- ◆ Save type

These backup status reports cover both regular and deduplication clients.

Backup type and save type information

Backup type is one of the configuration parameters for both NetWorker Backup Statistics and NetWorker Backup Status reports, and it is one of the fields of information included in these reports. The backup type indicates whether the files backed up were regular files, bootstrap files, indexes, or a particular database file.

Specialized NetWorker modules (such the Module for Oracle and Module for SAP) are used to back up the various databases. Most of these modules apply a distinct prefix when backing up a save set. This prefix enables NetWorker software to identify the backup type and include it in the reports.

A couple of the Backup Status reports (Save Set Details and Save Set Details by Client) include an additional field of information called save type. The save type can be any one of the following:

- ◆ Bootstrap
- ◆ Index
- ◆ Save
- ◆ **Save** (backup command)

Types of NetWorker backup status reports and configuration

The NetWorker Backup Status Report category includes both basic and drill-down reports. The report's Configure tab allows you to limit the scope of the report selected. The choice of available parameters depends on which report is to be generated.

The parameter options available within the NetWorker Backup Status Report category are described in [Table 61 on page 369](#).

Table 61 NetWorker backup status parameters (1 of 2)

Parameter	Description	Options
Server Name	Selects one or more NetWorker servers.	Selected server names
Group Name	Selects one or more savegroups.	Selected group names
Group Start Time	Limits the report to a specified time range. The default range is one day for save set details reports.	Start and end dates
Client Name	Selects one or more clients.	Selected client names
Save Set Name	Selects one or more save sets.	Selected save set names

Table 61 NetWorker backup status parameters (2 of 2)

Parameter	Description	Options
Backup Type	Selects one or more file types.	List of supported file types.
Level	Selects one or more backup levels.	<ul style="list-style-type: none"> • Full • Incremental • Skip • Level 1-9 (Partial list of options)
Status	Selects status.	<ul style="list-style-type: none"> • Successful • Failed • Interrupted

The parameters available for each report type are listed in the user interface.

Completion data retention and NetWorker backup status

The settings for the completion data policy impact the data that is available to the NetWorker Backup Status reports. The report cannot display data that has expired, because it has been removed from the database.

Thus, even if a one-year time range is specified for the Group Start Time parameter, the report displays only six months if the limit of the completion data policy is six months.

Backup status basic reports

Within the NetWorker Backup Status report category, choose any of the basic reports listed in the user interface. When a report has been chosen, the Configuration tab displays boxes listing the selected parameters for that report. To exclude unwanted parameters from the report, remove them from the list. [“How to configure a report” on page 358](#) provides information on selecting and removing parameters.

Backup status drill-down reports

The drill-down reports are comprised of multiple NetWorker Backup Status basic reports, connected in a predetermined sequence. [“Drill-down reports” on page 357](#) provides general information about drill-down reports. When a report has been chosen, the Configuration tab displays boxes with lists of the selected parameters for the top-level report. Thus, if the top layer of the drill-down report is a Daily Summary report, the configuration parameters are the same as they would be for the basic report, Daily Summary.

To exclude unwanted parameters from the report, remove them from the list. [“How to configure a report” on page 358](#) provides information on selecting and removing parameters.

NetWorker clone reports

The Clone reports, available from the Reports task pane in the Console window, allow you to view the history of automatic and scheduled clone operations that have been performed by NetWorker servers for any server version 7.6 Service Pack 2 and later.

Four different types of clone reports can be generated:

- ◆ Server Summary
- ◆ Clone Details

- ◆ Save Set Details
- ◆ Clone Summary Over Time

Be aware that clone reports may not be up-to-date because clone records are gathered by the console server every 12 hours.

Types of NetWorker clone reports and configuration

The NetWorker clone report category includes basic and drill-down reports for each selected NetWorker server within the enterprise. The Configuration tab allows you to limit the scope of the report that was selected.

The parameters available for clone reports are described in [Table 62 on page 371](#). The specific parameters available depend on which clone report is selected.

Table 62 Clone report parameters

Parameter	Description	Options
NetWorker Server	Select one or more NetWorker servers.	Selected server names
Client Name	Name of the NetWorker client whose save sets were cloned.	Selected client names
Clone Name	Name of the scheduled clone resource used for cloning.	Selected clone resource
Save Set	Cloned saveset name.	Selected save set names
Level	Backup level of the clone.	<ul style="list-style-type: none"> • Full • Incremental • Skip • Level 1-9 (Partial list of options)
Status	Final completion status of the clone.	<ul style="list-style-type: none"> • Successful • Failed • No save sets found
Type	Type of clone operation.	<ul style="list-style-type: none"> • Scheduled • Manual
Start / End Time	Limits the report to a specified time range. The default range is one day for save set details reports. Note: The date/time format available depends on the language locale of the operating system.	Start time of clone End time of clone

Clone basic reports

Within the Clone report category, choose any of the basic reports listed in the user interface. Once a report is chosen, the Configuration tab displays boxes with lists of the selected parameters for that report. To exclude unwanted parameters from the report, remove them from the list. [“How to configure a report” on page 358](#) provides information on selecting and removing parameters.

Clone drill-down reports

The Clone Summary over Time drill-down report consists of the basic clone reports, connected in a predetermined sequence. [“Drill-down reports” on page 357](#) provides general information about drill-down reports.

The configuration parameters for the drill-down report are the same as the parameters for the Server Summary basic clone report.

To generate the Clone Summary Over Time report, first specify the same parameters as those in the Server Summary clone report, which will be the first report displayed in the sequence.

To drill down to the clone detail level, perform one of the following, depending on your viewing mode:

- ◆ When in Table mode, double-click on any individual row referencing the desired NetWorker server.
- ◆ When in Chart mode, click anywhere in the chart area of the desired NetWorker server.

The Clone Details report for the selected NetWorker server appears. Return to the Server Summary report to select another server to explore.

To drill down to the Save Set Details level, perform one of the following, depending on your viewing mode:

- ◆ When in Table mode, double-click on any individual row referencing the desired clone resource name.
- ◆ When in Chart mode, click anywhere in the chart area of the desired clone resource name.

The Save Set Details report for the selected clone resource appears. Return to the Clone Details report to select another client to explore.

NetWorker recovery reports

The Recovery reports, available from the Reports task pane in the Console window, allow you to view the history of recovery operations that have been performed by NetWorker servers for any server version 7.3 and later. Additionally, NMC checks for new recovery operations and stores the recover statistics in the Console database every 12 hours and every time a scheduled savegroup backup completes.

Note: Since NMC gathers reporting data from pre-7.6 servers, and allows for recovery jobs for pre-7.6 clients, there may be missing fields in the recover statistics for these jobs. However, NMC still populates the Console database with information about those jobs and generates the reports, leaving any missing fields empty.

Reports can be viewed in both Chart and Table modes, with the Table mode set as the default mode. Four different types of recover reports can be generated:

- ◆ Server Summary
- ◆ Client Summary
- ◆ Recover Details
- ◆ Recover Summary Over Time

Be aware that recovery reports may not be up-to-date because recover job history is gathered by the console server every 12 hours and on completion of every scheduled backup.

Types of NetWorker recovery reports and configuration

The NetWorker recovery report category includes basic and drill-down reports. The different types of reports included within the NetWorker Recover Statistics report category provide recover statistics for each selected NetWorker server within the enterprise.

The Configuration tab allows you to limit the scope of the report that was selected.

The parameters available within the NetWorker Recovery report category are described in [Table 63 on page 373](#). The specific parameters available depend on which NetWorker Recovery Statistics report is selected.

Table 63 NetWorker recovery statistics parameters

Parameter	Description	Options
NetWorker Server	Managed hosts within the enterprise.	Selected server names
Source Client Name	One or more clients whose data is being recovered.	Selected client names
Target Client	The client where the data is being recovered to.	Selected target client names
Initiating Client	The client that initiated the recover.	
User	Name of the user who initiated the recover.	Selected usernames
Size	The size of the recover	
Number of files	For file system recoveries, the number of files in the recover.	
Start time/End time	Limits the report to a specified time range. Note: The date/time format available depends on the language locale of the operating system.	Start time of recover End time of recover
Completion Status	Final status of the recover	<ul style="list-style-type: none"> • Successful • Failed

The parameters available for each report type in the NetWorker Recovery Statistics report category are listed in the user interface.

Recovery Statistics basic reports

Within the NetWorker Recovery Statistics report category, choose any of the basic reports listed in the user interface. Once a report is chosen, the Configuration tab displays boxes with lists of the selected parameters for that report. To exclude unwanted parameters from the report, delete them from the list. [“How to configure a report” on page 358](#) provides information on selecting and removing parameters.

Recovery Statistics drill-down report

This drill-down report consists of multiple NetWorker Recovery Statistics basic reports, connected in a predetermined sequence. [“Drill-down reports” on page 357](#) provides general information about drill-down reports.

The configuration parameters for a drill-down report are the same as the parameters for the top-level report in the report sequence. Thus, if the top layer of the drill-down report is a Server Summary report, the configuration parameters are the same as they would be for the basic report, Server Summary.

When a report is chosen, the Configuration tab displays boxes that list the selected parameters for the top-level report.

To exclude unwanted parameters from the report, delete them from the list. “[How to configure a report](#)” on page 358 provides information on selecting and removing parameters.

Recover Summary Over Time

Recover Summary Over Time is a drill-down report sequence that allows you to explore the history of recover jobs that were performed by NetWorker servers over a period of time.

To generate the Recover Summary Over Time report, you must first specify the same parameters as those in the Server Summary report, which will be the first report displayed in the sequence.

To drill down to the client level, perform one of the following, depending on your viewing mode:

- ◆ When in Table mode, double-click on any individual row referencing the desired NetWorker server
- ◆ When in Chart mode, click anywhere in the chart area of the desired NetWorker server.

The Client Summary report for the selected NetWorker server appears. Return to the Server Summary report to select another server to explore.

To drill down to the Recover Details level, perform one of the following, depending on your viewing mode:

- ◆ When in Table mode, double-click on any individual row referencing the desired NetWorker client
- ◆ When in Chart mode, click anywhere in the chart area of the desired NetWorker client

The Recover Details report for the selected NetWorker client appears. Return to the Client Summary report to select another client to explore.

Recovery data retention policy and configuration

The retention policy for the recover statistics used to generate these reports can be set with the other retention policies currently defined from the Data Retention page in the Reports task pane. The default retention policy for these statistics is 1 year.

Data Domain statistics reports

The Data Domain reports, available from the **Reports** task pane in the Console window, provide Data Domain deduplication backup statistics for each selected NetWorker client.

Information on Data Domain reports is provided in the *EMC NetWorker Data Domain Deduplication Devices Integration Guide*.

Avamar Statistics reports

The NetWorker Avamar Statistics reports, available from the **Reports** task pane in the Console window, provide deduplication backup statistics for each selected NetWorker client.

Reports can be viewed in Table mode. There are four different types of reports that can be generated from the deduplication statistics:

- ◆ Client Summary

- ◆ Save Set Summary
- ◆ Save Set Details
- ◆ Backup Summary

Types of Avamar Statistics reports and configuration

The Avamar Statistics report category includes basic and drill-down reports.

The Configure tab allows you to limit the scope of the report that was selected.

The parameters available within the NetWorker Deduplication Statistics report category are described in [Table 64 on page 375](#). The specific parameters available depend on which NetWorker Deduplication Statistics report is selected.

Table 64 Avamar Statistics parameters

Parameter	Description	Options
Server Name	Selects one or more servers	Selected server names
Client Name	Selects one or more clients.	Selected client names
Group Name	Selects one or more groups	Selected group names
Save Set Name	Selects one or more save sets.	Selected save set names
Save Time	Limits the report to a specified time range. The default range is one day for save set details reports. Note: The date/time format available depends on the language locale of the operating system.	save time (range)
Backup Level	Select one or more backup levels.	<ul style="list-style-type: none"> • Full • Incremental • Skip • Level 1-9 (Partial list of options)

The parameters available for each report type in the Avamar Statistics report category are listed in the user interface.

Avamar Statistics basic reports

Within the Avamar Statistics report category, choose any of the basic reports listed in the user interface. Once a report is chosen, the Configure tab displays boxes with lists of the selected parameters for that report. To exclude unwanted parameters from the report, delete them from the list. [“How to configure a report” on page 358](#) provides information on selecting and removing parameters.

Avamar Statistics drill-down reports

The drill-down report, Backup Summary, consists of multiple NetWorker deduplication Statistics basic reports, connected in a predetermined sequence. [“Drill-down reports” on page 357](#) provides general information about drill-down reports.

The configuration parameters for the drill-down report are the same as the parameters for the top-level report in the report sequence. Thus, if the top layer of the drill-down report is a Client Deduplication Summary report, the configuration parameters are the same as they would be for the basic report, Client Deduplication.

When a report is chosen, the Configure tab displays boxes that list the selected parameters for the top-level report. To exclude unwanted parameters from the report, delete them from the list. [“How to configure a report” on page 358](#) provides information on selecting and removing parameters.

Event reports

These reports provide summary information about current events on NetWorker, Avamar, and Console servers within the Enterprise. Additional details about a particular event can be displayed, including annotation contents. While the Events window within the NetWorker Console displays the current events of the NetWorker servers (and Avamar server system events), the Event reports provide additional features. The reports enable you to organize, export, and print the event data.

The *NetWorker Avamar Integration Guide* provides information on Avamar.

Event reports can include this information:

- ◆ Number of events
- ◆ Priority of events
- ◆ Category of events
- ◆ Server name
- ◆ Server type
- ◆ Event time
- ◆ Notes and annotations

Note: When an event has been resolved, it does *not* remain in the records.

Types of event reports and configuration

The Events report category includes both basic and drill-down reports.

The report's Configure tab allows you to limit the scope of the report.

The Event parameters are described in [Table 65 on page 377](#). The specific parameters available depend on which Event report is being configured.

Note: Data retention policies do *not* have any impact on Event reports.

Table 65 Event parameters

Configuration parameter	Description	Options
Server Name	Selects one or more managed hosts.	Selected server names
Server Type	Selects some or all server types in the enterprise. Only the names of servers that have current events are shown.	Console NetWorker Avamar
Priority	Selects only priority events. Priority represents the relative severity of the event. Table 70 on page 390 provides descriptions of the priorities.	Warning Waiting Notice Info Emergency Critical Alert
Category	Selects only category events, or all categories. Category refers to the source of the event.	Database Backup Registration Savegroup
Event Time	Selects a time range. This parameter applies only to the Annotation Details report.	Event time (range)

Event basic reports

Within the Events report category, select any of the basic reports listed in the user interface. When a report has been chosen, the Configuration tab displays boxes listing the selected parameters for that report.

To exclude unwanted parameters from the report, remove them from the list. [“How to configure a report” on page 358](#) provides information about selecting and removing parameters.

Additional information

These resources provide more information about the contents of Event reports:

- ◆ [“Working with notes” on page 390](#) provides information on NetWorker Console notes.
- ◆ The *EMC NetWorker Error Message Guide* provides descriptions of NetWorker software error messages and troubleshooting procedures.
- ◆ [Chapter 27, “Troubleshooting”](#) provides information on troubleshooting NetWorker software issues.

Event drill-down reports

The drill-down reports consist of multiple Event basic reports, connected in a predetermined sequence. [“Drill-down reports” on page 357](#) provides general information about drill-down reports.

The configuration parameters for a drill-down report are the same as the parameters for the top-level report in the report sequence. Thus, if the top layer of the drill-down report is a Server Summary report, the configuration parameters are the same as they would be for the basic report, Server Summary. When a report has been chosen, the Configuration tab displays boxes listing the selected parameters for the top-level

report. To exclude unwanted parameters from the report, remove them from the list. [“How to configure a report” on page 358](#) provides information on selecting and removing parameters.

Host reports

The Hosts report category includes only basic reports. There are two basic reports, as described in [Table 66 on page 378](#).

Table 66 Host reports

Report name	Purpose	Configuration parameters	Default
Host List	Provides an overview of servers in the enterprise, including: <ul style="list-style-type: none"> • Whether the Capture Events feature is enabled for the server. • Whether the Gather Report Data feature is enabled for the server. • Where the server is located in the enterprise path. 	None	All servers
Enterprise Inventory	Allows movement through the Enterprise. Limit the report's scope by first viewing one of the lower-level folders within the Enterprise: <ul style="list-style-type: none"> • Start from Enterprise folder. • Start from selected folder. 	Enterprise Path	Start from Enterprise folder

[“Enterprise” on page 426](#) provides a description of the Enterprise and its folders.

User reports

The Users report category provides information on NetWorker Console user activity. [Chapter 16, “Console Server Management”](#) provides information about NetWorker Console users and creating user accounts.

The Users report category includes only basic reports, no drill-down reports. The **Full Name** and **Description** information appears in the User reports only if this information was specified when the user was created.

Device reports

Device reports provide information about the way devices are being used. They show scheduled and manual backup activity on one or more selected devices over time. You can identify periods of heavy activity or inactivity. Device reports aid NetWorker administrators in performance tuning, and they help identify bottlenecks. For example, if all drives are being used continuously for a long period of time, at maximum throughput, backup speeds may improve by adding tape drives or moving clients to another backup server.

Types of Device reports and configuration

The Devices report category includes only one report, the Drive Utilization report. This report, which is a drill-down report, supports NetWorker servers running NetWorker software release 7.3 or later. The report includes backup activity data for all device types, including advanced file type devices and digital data storage devices.

When viewing a Drive Utilization report as a chart, it is automatically displayed as a Gantt chart, where the backup activity level of one or more devices is depicted in relation to time. Unlike with other reports, you cannot choose an alternate chart type.

Placing the cursor over the chart in Save Set view displays a tool tip that provides this information:

- ◆ Save set name
- ◆ Start time
- ◆ End time
- ◆ Client name
- ◆ Throughput value

Placing the cursor over the chart in Drive View displays a tool tip that provides this information:

- ◆ Drive
- ◆ Start time
- ◆ End time
- ◆ Throughput value

Note: One of the activities included in the Drive Utilization report is throughput. Since the Drive Utilization Report provides data for backup activities only, throughput values will normally be non-zero. However, zero (0) is considered a valid throughput value.

Cloud backup and recover reports

Cloud backup and recover reports display information on the Cloud usage for scheduled backups and recovers that are performed by the NetWorker server to and from the Cloud storage device.

Types of Cloud backup and recover reports and configuration

The Cloud backup and recover reports category includes basic and drill-down reports. [“Drill-down reports” on page 357](#) provides general information about drill-down reports.

The Configure tab allows you to limit the scope of the report that was selected. The parameters available within the Cloud backup and recover report are described in [Table 67 on page 379](#). The specific parameters available depends on which Cloud backup and recover report is selected.

Table 67 Cloud backup and recover parameters

Parameter	Description	Options
Server Name	Selects managed hosts within the enterprise.	Selected server names
Start Time	Limits the report to a specified time range. The default range is one day for the Backup Details report. Note: The date/time format available depends on the language locale of the operating system.	start time (range)

Table 67 Cloud backup and recover parameters

Parameter	Description	Options
Device Name	Selects the devices used for backup and recover.	Selected device names

Cloud backup and recover reports

Within the Cloud backup and recover report category, choose any of the basic reports listed in the user interface. Once a report is chosen, the Configuration tab displays boxes with lists of the selected parameters for that report. To exclude unwanted parameters from the report, delete them from the list. [“How to configure a report” on page 358](#) provides information on selecting and removing parameters.

Cloud backup and recover reports can include this information:

- ◆ NetWorker server — Name of the server.
- ◆ Device name — Name of the device used for backup or recover.
- ◆ Device type — Type of the Cloud storage device, for example, Atmos.
- ◆ Login Account — Cloud username used for logging in.
- ◆ Size — Backup or Recover size.
- ◆ Compression ratio — Ratio of the bytes of information written to or read from the Cloud to the total size of the backup or recover.
- ◆ Bytes transferred — Total number of bytes written to or read from the Cloud.
- ◆ Start time — Start time for the backup or recover.
- ◆ End time — End time for the backup or recover.
- ◆ Save Set Name — Displayed only for backup.
- ◆ User name — Name of the user who initiated the recover. Displayed only for recover.
- ◆ Client name — Displays the name of the client that was backed up. In case of recover, source client name is displayed.
- ◆ Status — Displays the status of backup or recover. For example: succeeded, failed, and so on.

The Device Backup Summary and Device Recover Summary reports can be viewed in both Chart and Table modes. The other reports can be viewed in Table mode. [“Interactive and document mode chart types” on page 363](#) provides general information on charts.

Inactive files report

A NetWorker administrator can manage inactive files on a client or group and set the NetWorker software to automatically generate a list of inactive files in an environment. Inactive files are files that have not been accessed or modified other than being backed up regularly. The period of time a file has been inactive is called the Inactivity Threshold.

The inactivity files report is not supported on releases earlier than release 7.4 of the NetWorker servers.

Client support for this feature will be enabled only on Windows platforms.

The Inactive files report is a drill-down report that lists the inactive files from the latest scheduled backup. The report operates at both the client and group level.

The inactive files report can do the following:

- ◆ Generate a report on the percentage of inactive files backed up as part of a group.
- ◆ Set the threshold time periods per group so that the percentage of inactive files in that group does not exceed the threshold time period.
- ◆ Set alerts so that the NetWorker software sends an alert when the threshold set for a group is exceeded.
- ◆ Provide a report that details the percentage of inactive files backed up as part of a group.
- ◆ Report the percentage of inactive files per client.

The range limit specification given to configure File Inactivity Threshold and File Inactivity alert threshold attributes can be configured within the following ranges:

- ◆ File Inactivity Threshold attribute can be set between 0-365 days.
- ◆ File Inactivity Alert Threshold attribute can be set between 0-99.

Group File Details

The Group file Details report provides statistical information about inactive files that are included in a scheduled backup. Data will be provided for every requested NetWorker group at the time of the last backup. Chart mode is the default mode for the report. The data can also be viewed in tabular mode for more detailed information.

When generating the Group Details report, you can specify the following parameters:

- ◆ One or more NetWorker servers. Only servers that have the Gather Reporting Data attribute turned on will appear in the selection list.
- ◆ One or more NetWorker groups for the selected NetWorker servers.

Client File Details

The Client File Details report provides information about inactive files backed up for selected NetWorker clients. Data will be provided for every requested NetWorker client at the time of the last backup. Chart mode is the default mode for the report. The data can also be viewed in tabular mode for more detailed information.

When generating the Client File Details report, you can specify the following parameters:

- ◆ One or more NetWorker servers. Only servers that have the Gather Reporting Data attribute turned on will appear in the selection list.
- ◆ One or more NetWorker groups for the selected NetWorker servers.
- ◆ One or more NetWorker clients for the selected NetWorker servers.

Customizing and saving reports

A customized report is a changed copy of a canned report. Canned reports can be changed and then saved under different names. You can preserve the report configuration parameters that are most useful for the enterprise.

A customized report can be rerun exactly the same way at a later time, and even by another user. This saves time if the same report information must be generated repeatedly.

Customized reports offer these additional options:

- ◆ Delete
- ◆ Rename
- ◆ Save
- ◆ Save As...
- ◆ Share

Since it is a copy, a customized report can be changed again and resaved, or even deleted. Reports can be saved either to preserve particular configurations (such as which servers are polled) or to save the view type (such as pie or bar chart).

Note: For NetWorker reporting purposes, the terms *customized* report and *saved* report are basically synonymous.

Customized reports appear alphabetically in the report hierarchy below the canned report from which they were created. They are stored in the Console database, which means that users can access them from wherever they are logged in to the NetWorker Console. This also makes them accessible by the command line reporting feature. [“Command line reporting” on page 385](#) provides more information about command line reporting.

These types of information are stored in customized reports:

- ◆ All options from the report’s Configure tab
- ◆ Column display preferences for tables
- ◆ Orientation (portrait or landscape)
- ◆ Current view type (table or chart)

If the view type is Chart, then the current chart type (bar, pie, plot, or stacked bar) is also saved. For charts, the current chart axis selection is also saved. [“Chart axis selection” on page 366](#) provides more information about chart axis selection.

Naming reports

When naming a report to save, keep in mind that the set of usable characters is limited in the same way as for hostnames and usernames. Report names may not contain:

- ◆ Characters having an ASCII representation number less than ASCII 32 (such as carriage return, bell, newline, escape)
- ◆ Comma (,)
- ◆ Slash (/) or backslash (\)
- ◆ Double quote (") or single quote (')

Note: Report names are *not* case-sensitive. Also, canned reports cannot be deleted or customized, and then saved under the same name as a report that already exists under the same parent folder or directory.

Saved file ownership and deleted users

When a user saves a report by using the **Save As** command, that user becomes the owner of the new report. When a Console Application Administrator deletes from the system a user who owns reports, then the Console Application Administrator sees a dialog box that shows all of the reports owned by that user, and can choose either to delete the reports or reset the owner to a different user.

Sharing reports

By default, customized reports are stored as private for each user. This means that if a user saves a report, it appears only in that user's report hierarchy. A report's owner or the Console Application Administrator may, however, enable it for sharing.

Only the original owner of a customized report or the Console Application Administrator may select:

- ◆ **Delete**, to delete the report.
- ◆ **Rename**, to rename the report.
- ◆ **Save**, to resave the report.
- ◆ **Share**, to add sharing to, or remove sharing from, the report.
- ◆ If the Console Application Administrator removes sharing, the report becomes private again to the original owner, the report's creator.



Any user viewing a sharable report may perform these operations on the report:

- ◆ Change any runtime parameter of the report (such as configuration or view type).
- ◆ Run the report, but not save changes to the report.
- ◆ Copy the report by using the **Save As** command.
- ◆ Chose the **Hide Other Users' Reports** option to toggle the view of reports between only those owned by the user (both private and shared) and all shared custom reports.

If a user copies a sharable report with the **Save As** command, that user becomes the owner of the new report, which is initially set as not shared.

Sharing a report

To enable sharing of a customized report:

1. From the **Console** window, click **Reports**.
2. Expand the report folder that contains the customized report to share.
3. Right-click the customized report, then select **Share**. The report is now shared, and is represented in the report hierarchy by a shared-report icon  or .

Once a report has been enabled for sharing, all users can see it in the report hierarchy.

Note: The Share option is a toggle. To disable sharing, right-click the shared report and select **Share**.

Exporting reports

Reports can be converted into other file formats and shared with others. [Table 68 on page 384](#) lists the file formats available when exporting reports.

Table 68 Report export formats

Format	Purpose
PostScript	For printing. Shows data totals.
PDF	For printing or viewing with a PDF viewer such as Adobe Acrobat. Shows data totals.
HTML	For viewing in a browser. Shows data totals.
CSV	For importing into other programs (such as spreadsheets) that accept the comma separated values (CSV) format. Does not show data totals. <hr/> Note: For raw data only. <hr/>

Exporting a report

You can choose to export a report as a file in a different format (for example, HTML, PDF, CSV, or PostScript). To export a report to a different file format:

1. From the **Console** window, click **Reports**.
2. Expand the report folder that contains the report to export, then click the report.
3. Click the **View Report** tab to display the report.
4. Right-click the **View Report** tab, select **Export**, then select a format.

Note: To sort or rearrange table columns in a report, export the report to CSV format. The columns then can be sorted or rearranged in a spreadsheet program.

5. In the **Save** dialog box, specify the filename and file location and then click **Save**.

Exporting non-ASCII characters

Due to a limitation in the embedded reporting tool, reports that contain multibyte characters cannot be exported to PostScript or PDF formats. Such characters are replaced by a “?” character.

To obtain a printed version of such a report, print directly from the Console window, or export to HTML format.

Note: ISO8859-1 characters can be exported to PostScript or PDF formats.

Command line reporting

Command line reporting offers these features:

- ◆ Allows reports to be run offline, either as needed or by using scheduling software that makes reports available at predetermined times.
- ◆ Makes use of both canned and customized reports, which can be exported in various formats.
- ◆ Provides a more advanced feature that requires a fair amount of knowledge about running and scripting from the command prompt of the Console server. This feature should be reserved for advanced users.

Note: Command line reports may only be printed or run to generate exported output. They cannot be saved or shared. Drill-down reports cannot be run from the command line.

The command line reporting program

The command line reporting program is **gstclreport**. It uses the JRE to run. Additionally, command line reports must be run on the NMC Console server host.

The options are typical command line options in the form of a hyphen (-) followed by one or two letters and an argument, if applicable. The *EMC NetWorker Command Reference Guide* or the UNIX man pages provide a complete description of the command and its options.

System performance

Each time the **gstclreport** command is run, it starts a separate JVM, which can use many system resources. The **gstclreport** command runs a database query and generates report output by using the results. Since this uses both CPU and memory resources on the host computer, it could affect performance of NetWorker software and of the host. Consequently, depending on the system used, it is probably not wise to run more than a few instances of the **gstclreport** command at the same time.

Security

The **gstclreport** command must contact the Console server in order to run a report. The command requires a valid username and password. A user either uses the **-P** option to type the password, or the command checks standard input to see whether the password is there. If a password is not supplied, the program prompts for a password.

On UNIX systems, use of the **-P** option is a security concern, because a user may type the **ps** command and see the commands that were used to start any program that is running.

To solve this problem, use scheduling software that can conceal password input. Alternatively, ensure that the scheduling system sends the password as standard input. For example:

```
echo password | gstclreport
```

A **cron** command can be used to schedule the report, or the command could be placed in a secure script file that is invoked by the **cron** command.

Java runtime environment

Support of command line reporting requires JRE version 1.6 or later to run the **gstclreport** command. The JRE must be installed before installing NetWorker software.

Additionally, you must add an environment variable named JAVA_HOME to your NetWorker server host. Open either the `gstclreport.bat` or `gstclreport.sh` file and follow the instructions at the top of the file to set up the correct environment for command line reporting.

Printing reports

All reports can be printed. This allows for the sharing of report data with users who are unable to view it online.

To print a report:

1. From the **Console** window, click **Reports**.
2. Expand the report folder that contains the report to print, then click the report.
3. Click the **View Report** tab to display the report.
4. Right-click anywhere on the **View Report** tab, then select **Print**.
5. From the **Print** dialog box, select the appropriate options on each tab, then click **Print**.

The `-x print` option in the **gstclreport** command is also available.

This chapter covers these topics:

- ◆ Overview of events and monitoring 388
- ◆ Events..... 388
- ◆ Monitoring window..... 392

Overview of events and monitoring

The NetWorker Management Console (NMC) provides the ability to view details of current NetWorker, Avamar, and Data Domain systems. Information that can be monitored includes activities and operations related to devices and libraries, and events that require user intervention. NMC makes the administration of servers more efficient by providing a centralized means of monitoring activity throughout an enterprise. [“Managing various servers in the enterprise” on page 428](#) provides details on adding hosts to be monitored.

Events

An event signals that user intervention is required. For example, if a NetWorker server needs a new tape, the server alerts users to the situation by posting an event to the Console window.

NetWorker software generates an event based on various factors, including the following scenarios:

- ◆ The software or hardware encounters an error that requires user intervention to resolve.
- ◆ A NetWorker savegroup has failed.
- ◆ Drive ordering or serial number mismatch issues — a description of the problem is provided, along with a corrective action to fix the problem.
- ◆ Capacity monitoring — for example, reaching the space threshold on the deduplication node.
- ◆ NetWorker software is unable to poll a host it is monitoring for events or for generating reports.
- ◆ A license or enabler code managed by the License Manager is about to expire.

Some situations do not result in the generation of an event. For example, when a license managed by the NetWorker Console (instead of by the License Manager) approaches its expiration date. In this situation, a message is recorded in the NetWorker logs, but an event is not generated until the expired license causes a backup to fail. Check the Administration window from time to time for important messages.

Polling for System Events

From the System Options dialog box, you can set the poll interval for events and activities generated at system-level for the following:

- ◆ Events and reporting (in seconds)
- ◆ NetWorker activities (in seconds)
- ◆ Data Domain events (in seconds)
- ◆ NetWorker libraries (in hours)
- ◆ Avamar events (in hours)

Note: Event polling for NetWorker libraries and Avamar events can only be done to a maximum of once per hour. [“Console system options” on page 416](#) provides information on setting polling intervals.

Enabling or disabling the Capture Events option

The Capture Events option must be enabled for a given server before NetWorker software can monitor that server for events. This option is selected by default when a host is added.

To disable or reenable the **Capture Events** option:

1. From the **Console** window, click **Enterprise**.
2. Select the host for which the capturing of events is to be disabled or enabled.
3. Right-click the appropriate application, then select **Properties**.
4. Complete one of these steps as required:
 - To enable captured events, select **Features > Capture Events**.
 - To disable captured events, select **Features**, clear the **Capture Events** checkbox.

For Avamar servers, the **Capture Events** option monitors only system-level events. The Avamar documentation provides other event information.

5. If the host is a Data Domain system, select the **Configure SNMP Monitoring** tab.
 - a. Enter **public** in the SNMP community string field.
 - b. Enter the value of the SNMP process port. The default port is **162**.
 - c. Select the **SNMP Traps** (Data Domain system events) to be monitored by NetWorker.
6. Click **OK**.

Viewing events

To view events, from the **Console** window, click **Events**. If any events exist, they are displayed in the Console window.

The **Console** window includes columns that provide specific types of information about each event. [Table 69 on page 389](#) describes the various columns and the information they provide for NetWorker events.

Table 69 Events columns (1 of 2)

Column	Description
Priority	Represents the relative severity of the problem by displaying one of seven icons. Table 70 on page 390 describes each priority.
Server Name	Identifies the host that caused the event to be generated.
Server Type	Identifies the type of server to which the event belongs. Server types include but are not limited to NetWorker, Avamar, and Data Domain.
Time	Indicates the day of the week and time that the Console server discovered the problem. The time which an event is reported is always based on the time zone of the Console server. For example: If a savegroup fails at 11:00 A.M. in New York, a Console server in Los Angeles reports the event for the savegroup as occurring at 8:00 A.M. Note: The time format presented depends on the current locale setting. " Date and time formats " on page 358 provides more information.
Category	Classifies the source of the problem.







Table 69 Events columns (2 of 2)

Column	Description
Message	Displays the text of the error message that generated the event.
Annotation	Displays an icon when an annotation has been made. An annotation is a log associated with an event. “Working with annotations” on page 391 provides more information.
Note	Provides an editable field for making brief notes associated with an event. “Working with notes” on page 390 provides more information.

Event priorities

Each event is designated one of seven possible priorities. [Table 70 on page 390](#) lists the event priorities and the information they provide. When the Console window sorts events by priority, it lists the events in alphabetical order, with *Emergency* between *Critical* and *Information*.

Table 70 Event priorities

Icon	Priority	Description
	Alert	Error condition detected by the NetWorker server that should be fixed by a qualified operator.
	Critical	Severe error condition that demands immediate attention.
	Emergency	Condition exists that may cause NetWorker software to fail unless corrected immediately. This icon represents the highest priority.
	Information	Information about the current state of the server. This icon represents the lowest priority.
	Notification	Important information.
	Waiting	Indication that the NetWorker server is waiting for an operator to perform a routine task, such as mounting a tape.
	Warning	Non-fatal error has occurred.

Working with notes

The **Note** column of the **Console** window provides a place to record brief administrative information about an event. For example, you can enter:

- ◆ Name of the NetWorker administrator or operator assigned to the event.
- ◆ Letters or numbers that allow the sorting of events into a preferred order.

A note can contain up to 30 characters, and can be edited or deleted.

Adding a note

To add a note for an event:

1. From the **Console** window, click **Events**.
2. Double-click the cell of the **Note** column corresponding to the appropriate event, then type the text of the note in the cell.

3. After entering the text, click outside the cell.

Editing a note

To edit a note for an event:

1. From the **Console** window, click **Events**.
2. Double-click the note to edit, then change the text as appropriate.
3. After editing the note, click outside the cell.

Deleting a note

To delete a note from an event:

1. From the **Console** window, click **Events**.
2. Double-click the note, highlight the text in the cell, then press **Delete**.
3. After deleting the note, click outside the cell.

Working with annotations

The Annotation column provides a place to record comments associated with an event, and can accommodate more information than the Note column. Each annotation can be up to 12 KB in size. For example, use annotations to log steps taken to resolve an event.

When an annotation has been added to an event, an icon appears in the Annotation column of the Events window. Multiple annotations can be added to a single event, and unlike notes, they cannot be edited or deleted.

Viewing annotations

To view an annotation:

1. From the **Console** window, click **Events**.
2. Right-click the event with the annotation to be viewed, then select **Annotation**. Annotations are listed in descending order, with the most recently added annotation at the top of the list.
3. After viewing the annotation, click **Cancel** to close the dialog box.

Adding an annotation

To add an annotation:

1. From the **Console** window, click **Events**.
2. Right-click the event to be annotated, then select **Annotation**. The **Event Annotation** dialog box appears.
3. Type the text of the annotation.
4. To clear the text just entered, click **Reset**.
5. Click **OK**.

Dismissing an event

After an event has been viewed and acted on, it can be dismissed from the Console window. This helps prevent other users from acting unnecessarily on events that have already been resolved.

Note: Dismissing an event makes it disappear from the Console window for all NetWorker users.

To dismiss an event:

1. From the **Console** window, click **Events**.
2. Right-click the event to dismiss, then select **Dismiss**.
3. Click **Yes** to confirm the dismissal.

There are slight differences in how event dismissals are handled, depending on the source:

- ◆ Events from NetWorker software are automatically dismissed in the Console window when the problem that triggered the event is resolved.
- ◆ Events from device ordering or serial mismatch issues are automatically dismissed in the Console window when the problem is resolved via the corrective action provided.
- ◆ System events from an Avamar server (deduplication node) are *not* automatically dismissed in the Console window when the problem that triggered the event is solved. These events must be manually dismissed in the Console window.

Monitoring window

Open the Monitoring window from the Administration window taskbar to view details of current NetWorker server activities and status, such as:

- ◆ Running of automatic and manual savegroups
- ◆ Archiving, cloning, recovering, and browsing of client file indexes
- ◆ Alerts and log messages, and operations related to devices and jukeboxes

While the Monitoring window is used primarily to monitor NetWorker server activities, it can also be used to perform certain operations. These operations include starting, stopping, or restarting a group backup, as well as, starting and monitoring save set clones.

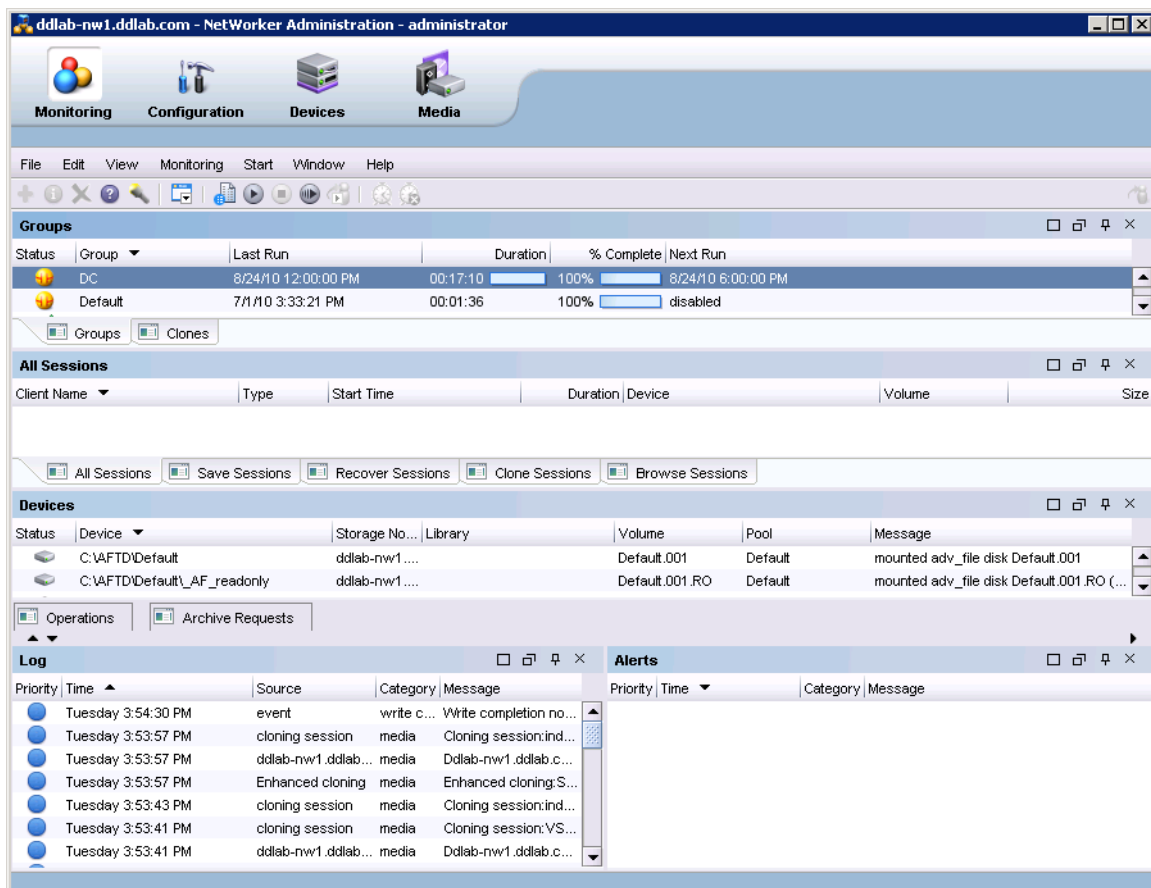

Viewing the Monitoring window

To view the full Monitoring window:

1. From the **Console** window, click **Enterprise**.
2. Highlight the host's Managed Application, then right-click and select **Launch Application...**

The **Administration** window appears.

3. From the **Administration** window, click **Monitoring**. The Monitoring window includes a docking panel that displays specific types of information.
4. Select the types of information you want to view from the docking panel.

A portion of the Monitoring window, known as the task monitoring area, is always visible across all windows. A splitter separates the task monitoring area from the rest of the window. You can click and move the splitter to resize the task monitoring area. The arrow icon in the top-right corner of the Monitoring window allows you to select which tasks you want to appear in this view.

Smaller windows appear within the Monitoring window for each window listed in [Table 71](#). Each smaller window, once undocked, is a floating window and can be moved around the page to customize your view. You can select multiple types from the panel to create multiple floating windows that can be viewed at the same time.

[Table 71](#) describes the various types of information available in the docking panel and the details each one provides.

Table 71 Monitoring window panel

Window	Information provided
Groups	Lists all groups related to the server, the backup status, the time the last backup was run, the duration of the backup, the completion percentage, and the next time the backup will run.
Clones	Lists all scheduled clone jobs with the last start time, the last end time, and additional details on the included save sets.
Sessions	Allows you to customize whether to display all session types, or only certain session types. The information provided depends on which session type you select. For example, if you select Save Sessions, the window lists clients, save sets, groups, backup level, backup start time, duration of the backup, devices, rate, and size.
Alerts	Lists the priority, category, time, and message of any alerts.
Devices	Lists devices, device status, storage nodes, libraries, volumes, pools, and related messages.
Operations	<p>Lists the status of all library and silo operations, including nsrjb operations run from the command prompt. Also lists user input, libraries, origin, operation data, operation start time, duration of the operation, progress messages, and error messages.</p> <p>The Operations window will display library data only for servers running NetWorker software release 7.3 or later.</p> <hr/> <p>Note: When displaying Show Details from the Operations window, the length of time that the window is displayed is controlled by the value entered in the Operation Lifespan attribute on the Timers tab of the Properties dialog box for the corresponding library. To access library properties, click Devices in the taskbar.</p> <hr/>
Log	Lists messages generated by the NetWorker server, including the priority of each message, the time the message was generated, the source of the message, and the category.
Archive Requests	Lists the status of all Archive Requests configured on the server, including the last time the data was archived, the date and time of the next scheduled archive, and any annotations.

Groups window

The Groups window displays groups that are in the process of completing, or have completed, their backup. You can use this window to identify which groups backed up successfully and which groups failed, and also to start, stop, or restart group backups.

The backup of a client group may fail for one of the following reasons:







- ◆ The NetWorker server failed.
- ◆ The NetWorker client failed.
- ◆ The network connection failed.

To find out more about a backup failure, check Group Backup details. [“Viewing group backup details” on page 396](#) provides more information.

Groups window backup status

The backup status is represented by an icon. [Table 72 on page 395](#) lists and describes each of the icons.

Table 72 Groups window icons

Icon	Label	Description
	Being cloned	The group backup is being cloned.
	Failed	The group backup failed.
	Interrupted	The group backup was interrupted.
	Never ran	The group backup never ran.
	Running	The group backup is running.
	Successful	The group backup successfully completed.
	Probing	The group is in a probing state.

When items on the Groups window are sorted by the Status column, they are sorted in alphabetical order based on the label of the icon.

When a group is in probing state, a message is sent when the group starts and finishes probing, and the results of the probing (run backup/do not run backup) are also logged. Probes do not affect the final status of the group, and the group status does not indicate the results of the probe. If probing indicates that a backup should not run, then the group status reverts back to its state prior to the group running.

IMPORTANT

Be sure to check the results of the probe in the log window to ensure that the probes indicated the backup be taken.

Groups backup operations

This section describes how to use the Monitoring window to start, stop, and restart group backups.

Starting a group immediately

You can override the scheduled backup start time and start the group manually. This is equivalent to selecting **Start Now in the Autostart** attribute of the Group resource.

Note: When a group backup is started manually, the NetWorker server runs the backup at the level of the next scheduled backup, such as full, levels 1 through 9, incremental, or consolidated.

To manually start a group backup:

1. From the **Administration** window, click **Monitoring**.
2. Click **Groups** in the docking panel.
3. Right-click the group to start, then select **Start**.
4. Click **Yes** to confirm the start.

The NetWorker server immediately backs up the clients in the group.

Stopping a group

To stop a group backup:

1. From the **Administration** window, click **Monitoring**.
2. Click **Groups** in the docking panel.
3. Right-click the group to stop, then select **Stop**.
4. Click **Yes** to confirm the stop.

Restarting groups

To restart a group backup:

1. From the **Administration** window, click **Monitoring**.
2. Click **Groups** in the docking panel.
3. Right-click the group to restart, then select **Restart Group**.
4. Click **Yes** to confirm the restart.

The backup continues from the point at which it was stopped.

Viewing group backup details

To view detailed information about a group backup:

1. From the **Administration** window, click **Monitoring**.
2. Click **Groups** in the docking panel.
3. Right-click the group to view, then select **Show Details**. The **Group Backup Details** dialog box appears.
4. View detailed information related to the group backups. If any messages were generated, the **Show Messages** button is enabled. Click **Show Messages** to view the messages.
5. Click **OK** to close the **Group Backup Details** dialog box.

Clones window

The Clones window displays the scheduled clone jobs and their completion status. This window also identifies which client save sets were cloned successfully and which save sets were not cloned successfully. You can also use this window to start a scheduled clone job immediately.

Scheduled clone operations

This section describes how to use the Monitoring window to start a scheduled clone operation and how to view the clone details for a client's save set.

Starting a scheduled clone immediately

You can start a scheduled clone job at any time instead of waiting for the scheduled start time.

To start a scheduled clone job immediately:

1. From the **Administration** window, click **Monitoring**.
2. Click **Clones** in the docking panel.
3. Right-click the scheduled clone to start, then select **Start**.
4. Click **Yes** to confirm the start.

The NetWorker server immediately starts the scheduled clone job.

Viewing the save sets for a scheduled clone

You can view the NetWorker clients and their save sets that are included in a schedule clone job. You can also determine which save sets were cloned successfully and which ones were not.

To view the clients and save sets for a scheduled clone job:

1. From the **Administration** window, click **Monitoring**.
2. Click **Clones** in the docking panel.
3. Right-click the scheduled clone to view, then select **Show Details**. The **Clone Details** dialog box appears.
4. Click **OK** to close the **Clone Details** dialog box.

Sessions window

Use the **Sessions** window to view the sessions that are running on a NetWorker server. You can change the view of this window to display these sessions:

- ◆ Save
- ◆ Recover
- ◆ Clone
- ◆ Browse
- ◆ All

The default setting for the Sessions window is to display Save sessions. [“Changing displayed session types” on page 397](#) provides instructions on viewing other session types.

Changing displayed session types

To change the type of sessions displayed on the Sessions window:

1. From the **Administration** window, click **Monitoring**.
2. Click **Sessions** in the docking panel.
3. Go to **View > Show** and select the type of sessions to display. To display all sessions currently running on the NetWorker Server, regardless of type, select **All Sessions**.

The column headings displayed on this window will differ depending on the type of sessions you chose to display.







Note: The ability to change the type of session being displayed is available only for NetWorker release 7.3 and higher.

Alerts window

The Alerts window displays alerts generated by a particular NetWorker server or Data Domain system that has devices configured on the NetWorker server. It includes priority, category, time, and message information.

The alert priority is represented by an icon. [Table 73 on page 398](#) lists and describes each of the icons.

Table 73 Alerts window icons

Icon	Label	Description
	Alert	Error condition detected by the NetWorker server that should be fixed by a qualified operator.
	Critical	Severe error condition that demands immediate attention.
	Emergency	Condition exists that could cause NetWorker software to fail unless corrected immediately. This icon represents the <i>highest</i> priority.
	Information	Information about the current state of the server. This icon represents the <i>lowest</i> priority.
	Notification	Important information.
	Waiting	The NetWorker server is waiting for an operator to perform a task, such as mounting a tape.
	Warning	Non-fatal error has occurred.

When items on the Alerts window are sorted by the Priority column, they are sorted in alphabetical order based on the label of the icon.

Devices window







The Devices window allows you to monitor the status of all devices, including NDMP devices. If the NetWorker server uses shared and logical devices, the window is adjusted dynamically to present a set of columns appropriate for the current configuration.

If the current server configuration includes a shared device, a Shared Device Name column appears on the Devices window. The name of the shared device appears in the Shared Device Name column. If other devices for that configuration are *not* shared devices, then the Shared Device Name column is blank for those devices. Additionally, since only a single device per hardware ID can be active at any given moment, the information for inactive shared devices is filtered out, so only one device per hardware ID is presented on the window at any time.

If the current server uses an AlphaStor library, then a Logical Name column is added to the Devices window to accommodate logical devices.

The device status is represented by an icon. [Table 74 on page 399](#) lists and describes each of the icons.

Table 74 Devices window icons

Icon	Label	Description
	Library device active	The library device is active.
	Library device disabled	The library device is disabled.
	Library device idle	The library device is idle.
	Stand-alone device active	The stand-alone device is active.
	Stand-alone device disabled	The stand-alone device is disabled.
	Stand-alone device idle	The stand-alone device is idle.

When items on the Devices window are sorted by the Status column, they are sorted in alphabetical order based on the label of the icon.

Operations window

The Operations window displays information about device operations. It includes this information:

- ◆ Status of the operation.
- ◆ Name of the library.
- ◆ Whether or not the operation requires user input.







For example, a labeling operation may want the user to acknowledge whether the system should overwrite the label on a tape. [“Supply user input” on page 400](#) provides instructions on how to deal with a user input notification.

- ◆ The origin, or source, of the operation.
For example, the interface, **nsrjb** or the NetWorker server.
- ◆ Time the operation started.
- ◆ Type of operation.
- ◆ Duration of the operation.
- ◆ Status messages from the operation.
- ◆ Any error messages.

Note: Only the last error message of the operation will appear in the Error Messages column. Move the mouse pointer over the cell containing the last error message to display the entire list of error messages.

The operation status is represented by an icon. [Table 75 on page 400](#) lists and describes each of the icons.

Table 75 Operations window icons

Icon	Label	Description
	Failed	The operation failed.
	Queued	The operation is waiting in the queue to run.
	Retry	The operation failed, but may work if you try again.
	Running	The operation is running.
	Successful	The operation completed successfully.
	User Input	The operation requires user input.

When items on the Operations window are sorted by the Status column, they are sorted in alphabetical order based on the label of the icon.

View operation details

To view detailed information about an operation:

1. From the **Administration** window, click **Monitoring**.
2. Click **Operations** in the docking panel.
3. Right-click the appropriate operation, then select **Show Details**.

The **Operation Details** dialog box opens, providing information about the completion of the operation. The **Completion Time** displays the time the operation finished. The time it took to complete the operation is the difference between the completion and start times of the operation.

To save operation details to a file, click **Save** in the **Operation Details** dialog box. When prompted, identify a name and location for the file.

Stop an operation

Certain operations can be stopped from the Operations window. To stop an operation:

1. From the **Administration** window, click **Monitoring**.
2. Click **Operations** in the docking panel.
3. Right-click the operation to stop, then select **Stop**.
4. Click **Yes** to confirm the stop.

Note: Operations that were started from a command line program such as the **nsrjb** command, cannot be stopped from the **Operations** window. To stop these operations, press **Ctrl-c** from the window where the command was started.

Supply user input

If the system requires user input, select the labeling operation in slow/verbose mode and the Supply User Input icon appears.

To supply input:

1. Right-click the operation, then select **Supply Input**.
2. Confirm whether or not to supply input.
 - If **Yes**, and input is supplied, the icon in the User Input column disappears.
If two users attempt to respond to the same user input prompt, the input of the first user will take precedence, and the second user will receive an error message.
 - If **No**, and input is not supplied, the operation will time out and fail.







Log window

To view the most recent notification logs, click the Log window from the docking panel in the Monitoring window. The Log window provides the priority, time, source, category, and message for each log.

Note: If a particular log file is no longer available, check the log file on the NetWorker server. The log files are located in this directory: <NetWorker_install_path>\logs. “[Viewing log files](#)” on page 663 provides information about viewing log files.

The log priority is represented by an icon. [Table 76 on page 401](#) lists and describes each of the icons.

Table 76 Log window icons

Icon	Label	Description
	Alert	Error condition detected by the NetWorker server that should be fixed by a qualified operator.
	Critical	Severe error condition that demands immediate attention.
	Emergency	Condition exists that could cause NetWorker software to fail unless corrected immediately. This icon represents the <i>highest</i> priority.
	Information	Information about the current state of the server. This icon represents the <i>lowest</i> priority.
	Notification	Important information.
	Waiting	The NetWorker server is waiting for an operator to perform a task, such as mounting a tape.
	Warning	Non-fatal error has occurred.





When items on the Log window are sorted by the Priority column, they are sorted in alphabetical order based on the label of the icon.

Archive Requests window

The Archive Requests window displays the current status of all archive requests that are scheduled on the NetWorker server. Use this window to identify which archive requests are running, completed, or failed, as well as when they were last run, and when they are scheduled to run next.

The archive status is represented by an icon. [Table 77 on page 402](#) lists and describes each of the icons.

Table 77 Archive requests window icons

Icon	Label	Description
	Disabled	The scheduled archive is disabled.
	Failed	The archive failed.
	Running	The archive is running.
	Scheduled	The archive is scheduled to run.
	Successful	The archive completed successfully.

When items on the Archive Requests window are sorted by the Status column, they are sorted in alphabetical order based on the label of the icon.

Viewing details of an archive operation

From the Monitoring window, you can view the details of an archive request, including the start time, the most recent completion time, and other information such as the pool and clone pool to which the archive request will write its data.

To view details of an archive operation:

1. From the **Administration** window, click **Monitoring**.
2. Click **Archive Requests** in the docking panel.
3. Right-click the appropriate archive request, then select **Show Details**.

The **Archive Request Details** dialog box opens, providing information about the completion of the archive request. The **Completion Time** displays the time the archive finished. The time it took to complete the archive is the difference between the completion and start times of the archive.

To save archive request information to a file, click **Save** in the **Archive Request Details** dialog box. When prompted, identify a name and location for the file.

Archive request operations

Use the Monitoring window to perform a number of archive request operations, such as canceling manual clone jobs, or starting, stopping, restarting, and disabling archive requests. The Monitoring window can also be used to schedule archive requests to start at a specific time in the future. These operations are equivalent to changing the Status attribute of the Archive Request resource, described in [“Scheduling data archives” on page 209](#).

Starting an archive immediately

You can start an archive immediately from within the Monitoring window. This will override and disable any scheduled archive for the selected archive request.

To start an archive immediately from the Monitoring window:

1. From the **Administration** window, click **Monitoring**.
2. Click **Archive Request** in the docking panel.
3. Right-click the appropriate archive request, then select **Start**.

4. Click **Yes** to confirm the start.

Stopping an archive in progress

To stop an archive in progress:

1. From the **Administration** window, click **Monitoring**.
2. Click **Archive Request** in the docking panel.
3. Right-click the appropriate archive request, then select **Stop**.
4. Click **Yes** to confirm the stop.

Scheduling an archive to start automatically

You can also use the Monitoring window to schedule an archive to start automatically at a later time.

To schedule an archive to start automatically at a later time:

1. From the **Administration** window, click **Monitoring**.
2. Click **Archive Request** in the docking panel.
3. Right-click the appropriate archive request and select **Schedule Archive**.
4. In the **Schedule Archive Request** dialog box, type the time that the archive should start, by using the *hh:mm* format.
5. Click **OK**. The **Next Run** column on the **Archive Requests** window displays the entered time.

Disabling a scheduled archive

If an archive request has a scheduled start time, you can disable the scheduled archiving.

To disable a scheduled archive:

1. From the **Administration** window, click **Monitoring**.
2. Click **Archive Requests** in the docking panel.
3. Right-click the appropriate archive request, then select **Disable Archive**.
4. Click **Yes** to confirm the disable.

This chapter covers these topics:

- ◆ Managing NetWorker Console server users 406
- ◆ Moving the Console server 413
- ◆ Setting system options..... 415
- ◆ Setting environment variables..... 419
- ◆ Accessing the Console Configuration Wizard 420
- ◆ NetWorker Console server maintenance tasks 421
- ◆ Displaying international fonts in non-US locale environments 423
- ◆ NetWorker License Manager 423

Managing NetWorker Console server users

The NetWorker Console (Console) server restricts user privileges based on the three roles described in [Table 78 on page 406](#). These roles cannot be deleted and their privileges cannot be changed.

Table 78 Console roles

User Role	Privileges
Console Security Administrator	<ul style="list-style-type: none"> • Add, delete, and edit users • Configure login authentication • Control user access to managed applications such as a NetWorker server • All tasks available to a Console User role
Console Application Administrator	<ul style="list-style-type: none"> • Configure Console system options • Set retention policies for reports • View custom reports • Specify the NetWorker server to backup the Console database • Specify a NetWorker License Manager server • Run the Console Configuration wizard • All tasks available to a Console User role
Console User	All tasks except for those tasks explicitly mentioned for the Console Security Administrator and the Console Application Administrator.

When Console is first opened, the default administrator user is assigned to all three Console user roles.

Login authentication for Console users

Console server supports two types of login authentication:

- ◆ Native Console authentication
- ◆ External authentication to an LDAP v3 compliant server

Native Console authentication is enabled by default and requires that user names and passwords be maintained on the Console server. No additional set up is required to enable native Console login authentication.

LDAP authentication enables you to log in to the Console server with user names and passwords that are maintained on a centralized LDAP v3 compliant server such as a Microsoft Active Directory server. Console user privileges are controlled by mapping LDAP user roles or LDAP user names to Console user roles. There is no need to add user names and passwords on the Console server. However, one must still add LDAP user names to user groups on the NetWorker server to enable privileges on the NetWorker server.

Note: You must use either native Console authentication or LDAP authentication. To switch from one mode to the other, use the Configure Logon Authentication wizard.

Configuring login authentication

To enable LDAP authentication:

1. Log in to the Console server as a user, such as the default administrator, who belongs to the Console Security Administrator role.
2. On each NetWorker server, add an external LDAP user to the NetWorker server Administrator's user group. This step ensures that once LDAP is enabled, at least one user will be able manage the NetWorker server and to add additional NetWorker users as required.

The LDAP user that you add should also belong to the LDAP user roles or LDAP user names that you specify later in [step 7](#).

- a. Click the **Enterprise** button on the taskbar.
- b. Highlight a host in the navigation tree, right-click **NetWorker**, and select **Launch Application**. The Administration window appears.
- c. Click the **Configuration** button on the taskbar.
- d. In the navigation tree, select **User Groups**.
- e. In the **User Groups** list, right-click **Administrators** and select **Properties**.
- f. Add the LDAP user to the **User** attribute. Use the following format to add the user:

```
User=LDAP_username, host=console_host
```
- g. Click **OK**.
3. From the **Console Setup** menu, select **Configure Login Authentication** to launch the **Configure Login Authentication** wizard.

The **Select Authentication Method** panel appears.

4. Select the **External Repository** radio button and click **Next**. The **Manage Authentication Authorities** panel appears.
5. Click **Add** and then provide information about your authentication authority in the remaining fields. For help on a field, click the question mark (?) at the bottom left side of the wizard panel.
6. Click **Next** when finished. The **Setup Console Security Administrator** panel appears.
7. Enter the LDAP user roles or LDAP user names that will be mapped to the Console Security Administrator role and click **Finish**.

Note: The LDAP user that was added to the NetWorker Server Administrator's list in [step 2](#) must also be added to the Console Security Administrator role.

You can now log in to the Console server using an LDAP user name and password that was mapped in this step.

Note: In LDAP mode, the user name *Administrator* is not allowed to log in even if it is defined in LDAP.

Post LDAP set up requirements

After LDAP authentication is enabled, perform the following tasks:

- ◆ Map additional LDAP user roles to Console user roles. [“Adding Console users and assigning to Console roles” on page 408](#) provides more information.
- ◆ Optionally, restrict access from the Console server to managed servers. [“Restricting a Console user’s view of managed servers” on page 409](#) provides more information.
- ◆ Add LDAP user names to NetWorker server user groups. This task enables users to perform operations on the NetWorker server. [“Granting Console users privileges on a NetWorker server” on page 410](#) provides more information.

Adding Console users and assigning to Console roles

This section describes how to add Console users and assign those users to Console roles. These procedures differ depending on whether native NetWorker login authentication or external LDAP login authentication is being used.

By default, Console users can view all managed NetWorker servers. However, Console users must still be granted explicit privileges on a NetWorker server. [“Granting Console users privileges on a NetWorker server” on page 410](#) describes how to manage access to NetWorker servers.

Adding Console users when using native authentication

To add Console users when using native login authentication:

1. Log in to the Console server as a Console Security Administrator.
2. From the **Console** window, click **Setup**.
3. In the left pane, right-click **Users**, then select **New**. The **Create User** dialog box appears, with the **General** tab displayed.
4. Enter a username.
 - Do not exceed 20 characters.
 - Do not use spaces, or any of these characters: < > /
 - Do not use characters with an ASCII value less than or equal to 32.
 - Do not begin a username with an underscore (_) character.
5. (Optional) Enter the full name of the user and a user description.
6. Select the Console user roles to be given to the user. [Table 78 on page 406](#) provides more information about Console user roles.
7. Enter the user password.

Note: Passwords must be at least eight characters long and cannot be the same as the user name. This requirement is enforced for all newly created or edited users. For customers upgrading from a previous release, this requirement will be enforced when user passwords are changed.

8. Reenter the password in the **Confirm Password** attribute and the click **OK**.

Adding Console users when using LDAP authentication

When an LDAP user logs in for the first time, a user object is automatically created on the Console server. You need only map LDAP user roles or LDAP user names to Console user roles.

If necessary, you can also create user objects before users log in for the first time. For example, you may want to restrict user access to managed servers before the user logs in for the first time.

To add Console users when using LDAP authentication:

1. (Optional) Create the Console user manually:
 - a. Log in to the Console server as a Console Security Administrator.
 - b. From the **Console** window, click **Setup**.
 - c. In the left pane, right-click **Users**, then select **New**. The Create User dialog box appears, with the Identity tab displayed.
 - d. In the User Name attribute, enter the LDAP user name.
 - e. Optionally, enter the full name of the LDAP user and a general description in the remaining attributes.
 - f. Click **OK**.
2. Map LDAP users to Console roles.
 - a. In the left pane, select **Roles**.
 - b. In the right pane, right-click a Console user role and select **Properties**.
 - c. In the External Roles attribute, add each LDAP user role or LDAP user name that is to be mapped. Add each entry on a separate line.
3. Click **OK**.

Restricting a Console user's view of managed servers

You can restrict Console users from viewing NetWorker servers by setting the permissions on the user object. [“Implications of restricting a Console user's view of managed servers” on page 410](#) provides information about the implications of restricting user views, see . [“Restricting report views” on page 366](#) provides information on how restricting views affects reporting.

To set permissions for a user to view servers:

1. Log in as Console Security Administrator.
2. From the **Console** window, click **Setup**.
3. In the left pane, click **Users**.
4. Right-click a username, then select **Permissions**. The **Edit User** dialog box appears, with the **Permissions** tab displayed.
5. To grant permission for the user to view various hosts, use the arrow keys to select the allowed hosts.
6. Click **OK**.

Note: Console users can manage data only on the servers they are allowed to view. However, to perform operations on the NetWorker server, Console users must also be granted explicit privileges on the NetWorker server. [“Granting Console users privileges on a NetWorker server” on page 410](#) provides more information.

Implications of restricting a Console user’s view of managed servers

Users can manage data, such as report data, only on servers they are allowed to view. However, even when they have permission to view a given server, the management operations they can perform on it are determined by their privileges on that server. [“Granting Console users privileges on a NetWorker server” on page 410](#) provides information on how these privileges are set.

The effects of restricting user views for various functions are as follows:

- ◆ In the **Events** window: The user sees only events from allowed NetWorker servers.
- ◆ In the **Enterprise** window: The user sees all of the hierarchy folders, but only the allowed NetWorker servers appear in those folders.
- ◆ In the **Libraries** window: The user sees only the devices controlled by allowed NetWorker servers.
- ◆ In the **Reports** window: The user sees report data only from allowed NetWorker servers.
- ◆ In the **Setup** window:
 - The user sees properties for all users, and his or her own properties and permissions.
 - The user can edit his or her own properties, but not permissions. Only the Console Security Administrator can edit user permissions, and see and edit permissions.

Note: Because each user can view and manage different sets of NetWorker servers, the contents of the reports can vary among users. For example, a shared backup summary report entitled “Building C Backups” will show different data for different users (even if the report is run at the same time) if the users’ permissions include different NetWorker servers. This applies to all report types, whether canned or customized, private or shared.

If no data is available for a given server, that server will not appear in any lists or reports, regardless of the user permissions.

[“Restricting a Console user’s view of managed servers” on page 409](#) provides information on how to restrict user views.

Granting Console users privileges on a NetWorker server

By default, each Console user must be granted explicit privileges on the NetWorker servers that they will manage.

Note: If you do not need to control NetWorker server privileges by individual user, you can disable this feature and give all users the same privileges that are granted to the Console server by default. To do so, clear the User Authentication for NetWorker system attribute, which is described in [“Setting system options” on page 415](#).

To grant Console users privileges on a NetWorker server:

1. Log in to the Console server as a user who belongs to the Administrator's group on the NetWorker server to which you are adding users.
 - If you are using native Console authentication, the default Console administrator user has administrator privileges on the NetWorker server.
 - If you are using external LDAP authentication, the LDAP user that was added in [step 2](#) of the section titled, "Configuring login authentication" on page 407, has administrator privileges on the NetWorker server.
2. Click the **Enterprise** button on the taskbar.
3. Highlight a host in the navigation tree, right-click NetWorker, and select **Launch Application**. The Administration window appears.
4. Click the **Configuration** button on the taskbar.
5. In the navigation tree, select **User Groups**.
6. In the User Groups list, right-click a user group and select **Properties**.
7. Add users to the User attribute. Use the following format to add a user:

```
User=username, host=console_host
```

where *console_host* is the name of the Console server host.

Note: If LDAP authentication is enabled, the username entered in this step must be the LDAP user name and *not* the LDAP user role.

8. Click **OK**.
[Chapter 17, "NetWorker Server Management"](#) provides more information about NetWorker server use groups and their privileges.

Resetting user preferences

An option is available in the Users task of the Console to reset a user's preferences to the settings as they were when the user first logged in.

To reset a user's preferences:

1. From the **Console** window, click **Setup**.
2. In the left pane, click **Users**.
3. Right-click a username, then select **Reset User Preferences**.
4. A dialog displays asking if you really want to remove all of their preferences before performing the reset. Click **Yes** to reset the preferences.

Deleting a user

Once a user has been deleted, that user can no longer log in to the Console server. Only the NetWorker administrator can delete other users.

To delete a user:

1. Log in as a Console Security Administrator.
2. From the **Console** window, click **Setup**.
3. In the left pane, click **Users**.

4. Right-click a username, then select **Delete**.
5. Click **Yes** to confirm the deletion.
 - If the user had saved customized reports, a dialog box prompts for the username to which to reassign those reports. Otherwise, the reports can be deleted.
 - If you are using LDAP authentication, you must also remove the user from the LDAP user role, which is maintained on the LDAP server.

Editing user properties

To change a password or other descriptive information about a user, edit the user properties. All users can edit their own properties. Only a NetWorker administrator, however, can edit properties of other users.

To edit user properties:

1. From the **Console** window, click **Setup**.
2. In the left pane, click **Users**.
3. Right-click a username, then select **Properties**. The **Edit User** dialog box appears, with the **General** tab displayed.
4. Change the user information as necessary. Other user information is displayed, but is not editable, including last-login information.

Note: If you are using native Console authentication, you can also change the administrator password by using the Console Configuration Wizard. "[Accessing the Console Configuration Wizard](#)" on page 420 provides more information.

5. Click **OK**.

Resetting the administrator password (native authentication only)

If the default administrator password is lost or forgotten, it can be reset by using the `GST_RESET_PW` environment variable.

Note: These steps apply only when native Console authentication is being used.

Microsoft Windows

To reset the native Console security administrator password on Windows:

1. From the **Start** menu, go to **Control Panel > System** and set the `GST_RESET_PW` variable in the **Environment Variables** dialog box to a value of **1**.

Note: How you navigate to the **Environment Variables** dialog box differs depending on which Windows operating system you use. Consult the documentation that accompanies your operating system for details.

2. Restart the **GST Service**. When the **GST Service** starts, the password resets.
3. Log in to the Console server and type **administrator** as the user name and type **administrator** as the password.

- Return to the Environment Variables dialog box and delete the **GST_RESET_PW** variable. This step prevents the password from being reset at each Console log in attempt.

UNIX systems

To reset the native administrator password on a UNIX system:

- Set **GST_RESET_PW** to a non-null value using the appropriate command for your shell, for example, in ksh:

```
export GST_RESET_PW "non null value"
```
- Stop and restart the Console server. [Table 8 on page 50](#) provides details. This should be done in the same shell where the password was set.
- Log in to the Console server and type **administrator** as the user name and type **administrator** as the password.
- Set **GST_RESET_PW** back to **null** using the appropriate command for your shell, for example, in ksh:

```
export GST_RESET_PW=
```

The next time the Console server is restarted, the password will not be reset again.

Moving the Console server

The Console server of NetWorker can be moved from one computer to another only if both computers use the same operating system. Reasons to move the Console server component include:

- ◆ The current computer has insufficient processing capabilities. For example, if there is a need for more memory or a faster processor.
- ◆ The current computer has insufficient space for the Console database.
- ◆ The current computer was damaged beyond repair.

To move the Console server component to another computer:

- Back up the existing Console database with the **savepsm** command. [“Performing a manual backup of the Console database” on page 80](#) provides more details.
- Set up the new computer with the same operating system as the one that is running the current software and is connected to the network.
- On the new computer, install the NetWorker Client software and the NetWorker Console server component.
 - This step includes meeting the prerequisites for installing NetWorker software. For example, the NetWorker client must already be installed. If using NetWorker License Manager, the License Manager software must either already be installed or be available on another host. For information, consult the *NetWorker Installation Guide*.
 - If you are using the License Manager and it is moved from one computer to another, enter the new License Manager hostname in the Console window. For information, refer to the *EMC License Manager Installation and Administration Guide*.
- On the remote NetWorker server, set up the new target computer as a Client resource. [“Task 6: Create a backup Client resource” on page 59](#) provides information about creating a Client resource.

5. For the Client resource of the source Console server, add the appropriate users to the **Remote Access** attribute on the **Globals (2 of 2)** tab.
6. Stop the Console server service on the source Console server. [Table 8 on page 50](#) provides more information.
7. Stop the Console server service on the target Console server.
8. Ensure the GST service is not running on the original backup host or on the host being used for the directed recover. Use the appropriate command or tools for your operating system to ensure the GST service is not running.
9. For UNIX systems, set the appropriate library path environment variable to the following:

```
Console_install_dir/sybasa/lib64
Console_install_dir/sybasa/lib (Linux)
```

The environment variable to set varies by platform:

- Solaris/Linux: LD_LIBRARY_PATH
- AIX: LIBPATH
- HP-UX: SHLIB_PATH

Note: If the Console is not installed in the default /opt/LGTONmc directory on Solaris, add *Console_install_dir/bin* to the LD_LIBRARY_PATH environment variable.

10. On the NetWorker server, you must have:
 - Client resources for the original backup host and the directed recover host.
 - The directed recover host listed in the remote access field of the Client resource for the original backup host.
11. Run the **recoverpsm** command on the new host using the **-c** option to identify the original host. Also use the **-O** option to recover only the database and not the gstd_db.conf credential file.

```
recoverpsm [-f] [-d recover_directory] -s NetWorker_server -c
original_Console_server -S gstd_on_original_Console_server -O
```

[Table 79 on page 415](#) provides a description of **recoverpsm** options. The *EMC NetWorker Command Reference Guide* or the UNIX man pages provide a complete description of the command and its options.

12. Use the **recover** program or the NetWorker **User** or **nwrecover** program to recover the gstd_db.conf configuration file to the new location. This will maintain your existing database login credentials.

For NetWorker 7.5 and higher, the gstd_db.conf file is located in the save set named CONSOLE_BACKUP_FILES.

Note: : If you were using LDAP authentication for 7.6.1 and lower versions, you must configure LDAP authorities again on the new Console server using the Configuration Login Authentication wizard. For versions 7.6.2 and higher, you can recover your LDAP authorities configuration from a previous 7.6.2 or higher backup of the Console database and configuration files. To recover, use the NetWorker User or **nwrecover** program to recover all the files under cst directory in the CONSOLE_BACKUP_FILES saveset. These files should be recovered to the cst directory under your new Console server installation.

13. If *recover_directory* is not the same as the Console database directory, copy the database file and the *gstd_db.conf* file, to the directory where the Console database resides.
14. Start the Console server service on the target Console server.
15. If you are using the License Manager and the License Manager host has changed, obtain a Host Transfer Affidavit from EMC support.

The host ID that is used for the authorization code is that of the License Manager computer. If the License Manager computer has not changed, then new authorization codes are unnecessary.

Table 79 The recoverpsm options

Option	Meaning
-f	Instructs the software to overwrite existing Console database files.
-d <i>recover_directory</i>	Specifies the destination directory for the recovered Console database. Include a full path for the directory. Partial paths are not supported.
-S <i>gst_on_source_Console_server</i>	Specifies the existing Console database on the source Console server. You must prepend gst_on_ to the name of the source Console server.
-O	Omit the recovery of the database credential file.
-s <i>NetWorker_server</i>	Specifies the name of the NetWorker server where the Console database backup resides.
-c <i>source_Console_server</i>	Specifies the short name of the source Console server, where the existing Console database resides.

Setting system options

NetWorker Console includes several options that affect performance. These options enable users to fine-tune the performance of the Console server. Only Console application administrators can set or change system options.

Setting a system option

To set a system option:

1. From the **Console** window, click **Setup**.
2. From the **Setup** menu, select **System Options**. The **System Options** dialog box appears.
3. Set a value, or enable or disable the appropriate system option.
4. Click **OK**.

IMPORTANT

Do not adjust these system options without careful consideration. A mistake in setting system options or environment variables can seriously degrade performance.

Console gets two configuration options from the environment (GST_MAXLOGSIZE and GST_MAXLOGVERS). Normally the default values are used; these environment variables can be changed by advanced users. [“Setting environment variables” on page 419](#) for more information provides more information.

Table 80 Console system options (1 of 2)

System option	Purpose
Log on Banner	Specifies the text to display in the user log on screen.
Debug level <hr/> Note: Alternatively, GST_DEBUG can be set as an environment variable. This allows users to troubleshoot the Console if they cannot access the Console window. The environment variable overrides the system option version (Debug level). To avoid having it override the system option indefinitely, unset the environment variable after use, and set the system option for general use.	Set the level of debugging information written to the gstd log file. (Increasing this value increases the number of operation and status messages that Console records.) <ul style="list-style-type: none"> To increase the number of program messages written to gstd log file, choose a larger value. To use less disk space, choose a smaller value Range: 1 to 10.
Polling interval for events and reporting (secs)	Set the minimum number of seconds that must pass before Console checks a NetWorker server for events. <ul style="list-style-type: none"> To make Console more responsive to new events, decrease the value. To decrease the load on the CPU, increase the value. Range: >= 2 Default: 20
Polling interval for NetWorker activities (secs)	Set the minimum number of seconds that must pass before Console checks a NetWorker server for updates to the Administration windows. <ul style="list-style-type: none"> To make the Administration windows more responsive to changes on the NetWorker server, decrease the value. To decrease the load on the CPU, increase the value. Range: >= 2 Default: 10
Polling thread factor	Determine the number of programming threads that are used when polling NetWorker servers. <ul style="list-style-type: none"> To make Console more responsive, increase the value. To decrease the load on the CPU, decrease the value. Range: 1 – 10 Default: 5
Polling interval for NetWorker libraries (hours)	Set the minimum number of hours that must elapse before the Console checks a NetWorker server for library information. <ul style="list-style-type: none"> To poll the NetWorker server for library information more frequently, decrease the number of hours. To poll the NetWorker server for library information less frequently, increase the number of hours. Range: Greater than or equal to 1. Default: 12
Polling interval for Avamar events (hours) <hr/> Note: In order for Avamar events to appear in NMC, they must be set to Acknowledge in the Events Management tab of the Avamar Administrator program.	Set the minimum number of hours that must elapse before the Console checks for Avamar events. Avamar events can include: <ul style="list-style-type: none"> hfscheck — validation of the data stored on the Avamar server. Disk health/hardware — status of the disks on the Avamar server (limited to “bad” or “failed” disk status). Replication events that occur on the Avamar server. Avamar events can be polled at hourly intervals: <ul style="list-style-type: none"> To poll for Avamar events more frequently, decrease the number of hours. To poll for Avamar events less frequently, increase the number of hours. Range: Greater than or equal to 1. Default: 12
Maximum number of log messages	Specifies the maximum number of log messages to display in the Log window, which is available by selecting Monitoring in the NetWorker server Administration window. Range: 1- 512 Default: 32

Table 80 Console system options (2 of 2)

System option	Purpose
NetWorker user auditing	<p>Enable auditing of user Console requests.</p> <ul style="list-style-type: none"> When enabled, this function logs all Console user requests to NetWorker servers. When this function is disabled, Console user requests to NetWorker servers are not logged. <p>Range: Not applicable Default: Disabled</p> <p>Audit records are written to the Console database, and the results are viewable in the Reports task of Console's main window. Chapter 14, page 14-351 provides for information about viewing reports.</p>
User authentication for NetWorker	<p>Set individual user authentication for functions a user can perform on a NetWorker server.</p> <hr/> <p>Note: Requires restarting the Console server to take effect.</p> <hr/> <p>This option restricts user access to a given NetWorker server <i>only</i> if the user groups on that server have been set up to do so. User groups can be created, modified, or deleted from the Administration window.</p> <ul style="list-style-type: none"> This option does not set restrictions on user views. When this function is disabled, all Console users who are allowed to access a NetWorker server have the same privileges on that server. When this function is enabled, access privileges on Console servers can vary among Console users. <p>Range: Not applicable Default: Enabled</p>
RPC ping via UDP when connecting to a NetWorker server	<p>Enable the use of user datagram protocol (UDP) when NetWorker Console first checks whether a NetWorker server is up and running. Set this option if the firewall allows for UDP connections. Note that there is a significant trade-off in performance.</p> <p>Range: Applicable Default: Enabled</p>

Individual User Authentication

Console security administrators can restrict or grant Console user access to NetWorker servers based on the Console username if the User Authentication for NetWorker system option has been enabled (with a subsequent restart of the Console server). This system option is enabled by default.

Requests to NetWorker servers through the Administration window always come from the Console server, regardless of any system option settings.

When the User Authentication for NetWorker system option is enabled, the requests to NetWorker servers appear (from the NetWorker side) to be coming from users on the Console server, rather than from the **gstd** process owner on the Console server.

When the system option is enabled, a NetWorker server allows requests only from users who belong to the Administrators group of the NetWorker server. The username of the Console daemon process owner must be included in the NetWorker Administrators group on NetWorker servers to which Console users have access. NetWorker administrators must also ensure that the usernames of Console users who have permission to view and manage those servers are included in the NetWorker server's Administrators group. [Table 81](#) provides examples. "[Administrator privileges](#)" on page 440 provides detailed information about the Administrators group.

Note: The username of the root or system user on the Console server *must* be specified, regardless of whether individual user authentication is used.

Table 81 Usernames for individual user authentication

On Console server	Operating system	Example of username to add to the NetWorker Administrators group ¹
Root or system user on the Console server—the Console daemon process owner (mandatory)	Microsoft Windows	system@winbox.petropep.com
	UNIX	root@unixbox.petropep.com
NetWorker Administrator	Microsoft Windows	administrator@winbox.petropep.com
	UNIX	administrator@unixbox.petropep.com
User	Microsoft Windows	user1@winbox.petropep.com
	UNIX	user1@unixbox.petropep.com

¹ Where winbox.petropep.com and unixbox.petropep.com are Console servers.

[Chapter 17, “NetWorker Server Management,”](#) describes how to include the user names in the NetWorker Administrators group

Impact on network connections

More network connections might need to be available when individual user authentication is enabled. This could have an impact on firewall considerations. [Appendix B, “Firewall Support”](#) provides information about firewalls.

When the User Authentication for NetWorker system option is set, a separate network connection is created from the Console server to a NetWorker server for each Console user that has an Administration window open to that server. This option is set by default.

When the user authentication for NetWorker system option is *not* set, there is only one network connection from the Console server to a NetWorker server that is being managed through NetWorker.

Setting environment variables

Table 82 on page 419 describes the three environment variables available in this NetWorker release. Variables are checked only when the Console server service starts, which is similar to how the **nsrd** daemon handles its corresponding variables.

Note: Environment variable names are case-sensitive.

Table 82 Console environment variables

Purpose	Environment variable
<p>Set the maximum size of the gstd log file before a new log file is created at Console server startup time. If this variable is undefined, the maximum size defaults to 1 MB.</p> <ul style="list-style-type: none"> To preserve more log information, increase the value. To use less disk space, decrease the value. <p>“The gstd log” on page 704 provides more information about the gstd log file.</p> <p>Range: >= 1 Default: 1 MB</p>	GST_MAXLOGSIZE
<p>Set the maximum number of historical versions of the gstd log file that Console retains. Older versions are deleted when the number of versions exceeds this value.</p> <ul style="list-style-type: none"> To preserve more log information, choose a larger value. To use less disk space, choose a smaller value. <p>“The gstd log” on page 704 provides more information about the gstd log file.</p> <p>Range: 1–999 Default: 4</p>	GST_MAXLOGVERS
<p>Set the level of debugging information written to the gstd log file. Setting this value higher increases the number of operation and status messages that Console records.</p> <p>GST_DEBUG can also be set as a system option (Debug level).</p> <ul style="list-style-type: none"> To increase the number of program messages written to gstd.log, choose a larger value. To use less disk space, choose a smaller value. <p>Range: 1–20 Default: 0</p>	<p>GST_DEBUG</p> <p>Note: This environment variable can be used to troubleshoot the product in cases where the user interface is not accessible. The environment variable overrides the system option version (Debug level). To avoid having it override the system option indefinitely, unset the environment variable after use, and set the system option for general use.</p>

Setting environment variables on Solaris and Linux systems

To set environment variables on UNIX systems:

- Open the **gst** file in a text editor. (This file is a Bourne shell script.) The file location varies depending on the platform:
 - Solaris and Linux: /etc/init.d/gst
 - AIX: /etc/rc.gst
 - HPUX: /sbin/init.d/gst

Note: By default, this is a read-only file. Check the file permissions and change them, if necessary, before editing it.

2. Add these lines to the beginning of the file:

```
variable_name=variable_value  
export variable_name
```

where:

- *variable_name* is the name of the environment variable to be set.
 - *variable_value* is the value to be assigned to the environment variable.
3. Save the changes.
 4. Stop and restart the Console server. [Table 8 on page 50](#) provides detailed instructions.

The preceding example is for the Bourne shell. For other shells, refer to the shell-specific documentation or man pages that describe how to set an environment variable.

Setting environment variables on Windows systems

To set environment variables in Microsoft Windows:

1. View the system variables.
 - a. From the **Start** menu, select **Settings>Control Panel>System**.
 - b. Click the **Advanced** tab.
 - c. Click **Environment Variables**.
 - d. In the **Environment Variables** dialog box, below **System Variables**, click **New**.
2. In the **New System Variable** dialog box, enter the variable name and value.
3. Click **OK**.

Accessing the Console Configuration Wizard

Note: Only Console Application Administrators can use the Console Configuration Wizard.

The following tasks can be performed from the Console menu options or from the Console Configuration Wizard.

- ◆ Set the NetWorker Administrator password.
- ◆ Specify the NetWorker server that will back up the Console database.
- ◆ Add NetWorker servers to the enterprise.

To access the Console Configuration Wizard:

1. From the **Console** window, click **Setup**.
2. From the **Setup** menu, select **Configuration Wizard**.

NetWorker Console server maintenance tasks

This section lists maintenance tasks associated with the NetWorker Console server.

Changing the service port used by the NetWorker Console database

By default, the NetWorker Console database uses port 2638 for TCP/IP communications. Other applications may also use this port or, as is the case with EMC AlphaStor or EMC DPA installed with default options, may have their own instance of the iAnywhere database installed, which can create conflicts if both applications are installed on the same host.

To resolve this problem, change the service port as follows:

1. Stop the GST Service. [Table 8 on page 50](#) has information about stopping the GST service.
2. Stop any other products that are using the iAnywhere database, for example, EMC AlphaStor or EMC DPA.
3. Ensure that no **dbsrv9** processes are running. If the **dbsrv9** processes are running, stop them.
4. Open a terminal or command prompt window.
5. Depending on the shell you are using, use the appropriate command (for example, **setenv** for csh, **export** for sh) to update the library path environment variable in the terminal window to the following location:

- Solaris: **/opt/LGTONmc/bin:/opt/LGTONmc/sybase/lib**
- Linux/AIX/HPUX: **/opt/lgtonmc/bin:/opt/lgtonmc/sybase/lib**
- Microsoft Windows (assumes default installation location):
C:\Program Files\Legato\Management\GST\sybase\bin

The environment variable to set varies by platform, for example:

- Solaris/Linux: LD_LIBRARY_PATH
- AIX: LIBPATH
- HP-UX: SHLIB_PATH

6. Edit the `gstd.conf` file to add or change the following line:

```
db_svc_port=port_number
```

For example:

```
db_svc_port=2639
```

The `gstd.conf` is located in the following locations:

- Solaris: `/opt/LGTONmc/etc`
 - Linux/AIX/HP-UX: `/opt/lgtonmc/etc`
 - Microsoft Windows: `C:\Program Files\Legato\Management\GST\etc`
7. Run the `gstconfig` command to update the port value in the NetWorker Console. The `gstconfig` command is located in the following locations:
 - Solaris: `/opt/LGTONmc/bin`
 - Linux/AIX/HP-UX: `/opt/lgtonmc/bin`
 - Windows: `C:\Program Files\Legato\Management\GST\bin`

8. Close the terminal or command prompt window.
9. Restart the GST Service.

Changing database connection credentials

When the NetWorker Console server is started for the first time, it automatically generates login credentials that it will use to log into the NetWorker Console database. This information is stored internally by the NetWorker Console server and the user does not need to know the required credentials. However, it may be necessary to force the Console server to change the database connection credentials.

To force the server to change the credentials:

1. Stop the GST Service. [Table 8 on page 50](#) has information about stopping the GST service.
2. Set the environment variable GST_RESET_DBPWD to any value. On Microsoft Windows system, this should be set as a System Variable and the system should be rebooted after the variable is set.
3. Restart the GST Service.
4. Delete the GST_RESET_DBPWD environment variable. On Microsoft Windows system, the system should be rebooted after the variable is set.

NMC server IP address/hostname updates

If the IP address/hostname of the NMC server is modified or protocols such as IPv6 are added or removed, perform the following:

1. Stop the GST Service. [Table 8 on page 50](#) has information about stopping the GST service.
2. Navigate to the NetWorker bin directory and run the platform-specific command:
 - On Windows, go to C:\Program Files\Legato\Management\GST\bin, and run **gstconfig**.
 - On Solaris, as root:
`LD_LIBRARY_PATH=/opt/LGTONmc/bin:/opt/LGTONmc/sybase/lib`
`export LD_LIBRARY_PATH`
`./gstconfig`
 - On Linux, as root:
`LD_LIBRARY_PATH=/opt/lgtonmc/bin:/opt/lgtonmc/sybase/lib`
`export LD_LIBRARY_PATH`
`./gstconfig`
 - On AIX:
`LIBPATH=/opt/lgtonmc/bin:/opt/lgtonmc/sybase/lib`
`export LIBPATH`
`./gstconfig`
 - On HP-UX:
`SHLIB_PATH=/opt/lgtonmc/bin:/opt/lgtonmc/sybase/lib`
`export SHLIB_PATH`
`./gstconfig`
3. Restart the GST service.

Displaying international fonts in non-US locale environments

To use or view data from a localized NetWorker server, ensure that the appropriate font is available to the Console server. The EMC Legato NetWorker Installation Guide provides more information about displaying international fonts on a Console server that is operating in English mode.

NetWorker License Manager

The NetWorker License Manager software provides centralized license management, which enables you to maintain all of an enterprise's NetWorker licenses from a single computer.

With the NetWorker License Manager, you can move NetWorker software from one computer to another, or change the IP address on an existing NetWorker server without having to reauthorize the software. The NetWorker License Manager can be installed as an option during the NetWorker software installation.

The latest *NetWorker License Manager Installation and Administration Guide* provides more information on how to install and use the NetWorker License Manager.

Entering an enabler code

To enter an enabler code if you are using LLM:

1. From the **Console** window, click **Setup**.
2. Right-click **Licensing**, then select **New**. The **Create** dialog box appears.
3. In the **Enabler Code** attribute, type the enabler code and leave the other attributes blank.
4. Click **OK**.

Deleting an enabler code

To delete an enabler code if you are using LLM:

1. From the **Console** window, click **Setup** and then click **Licensing**.
2. Right-click the license to delete, then select **Delete**.
3. Click **Yes** to confirm the deletion.

Entering an authorization code

To enter an authorization code if you are using LLM:

1. From the **Console** window, click **Setup** and then click **Licensing**.
2. Right-click the license to be authorized, then select **Properties**. The **Properties** dialog box appears.
3. In the **Auth Code** attribute, enter the authorization code for the product (the authorization code assigned to the specified permanent enabler or update enabler code).
4. Click **OK**. The license is now permanently enabled.

Changing the License Manager server

The License Manager server that manages NetWorker Console licenses can be changed at any time.

To change which host runs the License Manager:

1. Log in as a Console Application Administrator.
2. From the **Console** window, click **Setup**.
3. Right-click **Licensing**, then select **Change LLM Server**. The **Change LLM Server** dialog box appears.
4. In the **LLM Server** attribute, type the hostname of the appropriate server and click **OK**.

This chapter covers these topics:

◆ Enterprise	426
◆ Configuring a NetWorker server	433
◆ Configuring ConnectEMC	434
◆ Enabling BMR server support	436
◆ Parallelism and multiplexing	436
◆ Managing server access	440
◆ NetWorker User Groups	442
◆ Server communication issues within Microsoft Windows.....	446
◆ Notifications.....	447
◆ Indexes	454
◆ Updating NetWorker clients by using the software distribution feature	463
◆ Message log management.....	463
◆ Internationalization.....	465

Enterprise

The Enterprise is a visual representation of the NetWorker Console control zone. Various servers in the enterprise such as NetWorker, Data Domain, and Avamar servers can be monitored for events, and various reports can be generated on events, backups, and user activity.

Enterprise components

The Enterprise includes these components:

- ◆ Hosts

A host, also known as a *managed node*, is the NetWorker, Data Domain, or Avamar server being monitored. A host terminates a branch in the Enterprise.

- ◆ Folders

The purpose of folders is to enable the Enterprise to contain multiple levels. Each folder can contain more folders, more hosts, or more of both.

Organizing NetWorker servers

Use the Enterprise to organize the NetWorker servers by some logical or functional criteria. Examples of organizational criteria include:

- ◆ By geography, thus putting all the hosts from the same city or country in the same folder. [Example 32 on page 426](#) provides information.
- ◆ By function of the computers backed up by the NetWorker servers, such as having the servers that back up web servers in one folder, and the servers that back up mail servers in another.
- ◆ By administrative divisions within the Enterprise, such as having separate folders for servers that back up Marketing, Sales, or Engineering computers.

Since there can be multiple copies of a host in the Enterprise, multiple folders can also be created and maintained. With each folder based on different organizational criteria, the organization can be viewed in different, yet parallel and complementary ways.

Example 32 An enterprise arranged by geographic location

[Figure 32 on page 427](#) shows an Enterprise arranged by geographic location. There are three folders, one for each country where the NetWorker servers are located: USA, France, and Australia. Each folder contains a number of hosts that correspond to NetWorker servers named for the city where they are located. The Australia folder, for instance, contains three host computers labeled *perth1*, *perth2*, and *sydney*.

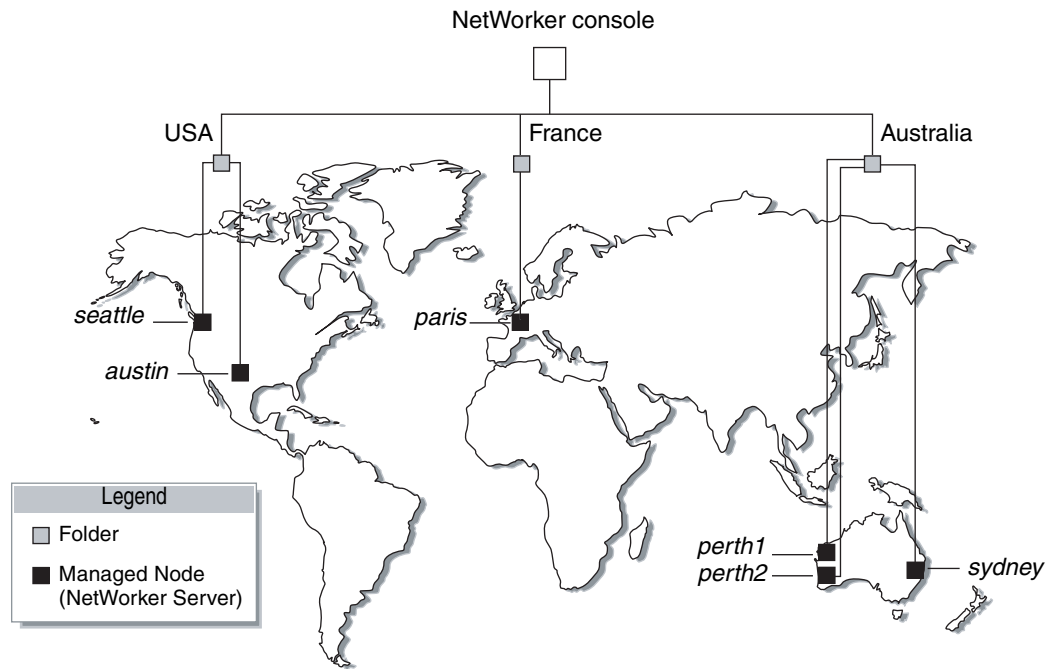

Figure 32 NetWorker servers worldwide

Viewing the enterprise

In the Console window, the organization of the NetWorker servers can be viewed in much the same way as the contents of a file system can be viewed by using a file manager program.

To view the Enterprise:

1. From the **Console** window, click **Enterprise**.
 - The left pane displays folders and hosts in a tree-like arrangement to illustrate the organization of the NetWorker servers.
 - The right pane displays the contents of the selected folder or host.
2. Select a view option as described in [Table 83 on page 427](#).

Table 83 Viewing the enterprise

To:	Do this:
Show or hide contents of the Enterprise.	Click Enterprise.
Show or hide contents of a folder.	Click the folder.
Show the managed applications installed on a host computer.	Click the host.

Managing various servers in the enterprise

NetWorker Console enables centralized management of NetWorker, Data Domain, and Avamar 3.7 and later servers within the Enterprise. You can add, delete, move, and copy servers as needed. All of these functions can be performed through the Console window. When using NetWorker software to manage a large number of NetWorker servers, it might be more efficient to add or delete multiple hosts by using a single command from the command prompt. [“Adding or deleting multiple servers by using a hostname file” on page 431](#) provides further information.

The server management activities include, but are not limited to, operations related to devices and libraries, and events that require user intervention.

Adding a managed host

The Console window can display server events, which allow server activity-reports to be generated.

Note: Data Domain servers are added as managed hosts automatically when a Data Domain device is configured with the new New Device Wizard. The *EMC NetWorker Data Domain Devices Integration Guide* provides more information about Data Domain as a managed host.

NetWorker Console supports hosts that use NetWorker server software release 7.2.x or later and Avamar release 3.7.2 or later.

To add one of these hosts to the Enterprise:

1. From the **Console** window, click **Enterprise**.
2. In the left pane, right-click **Enterprise**, then select **New>Host**. The **Add New Host** wizard appears.
3. Enter a hostname, IP address, DNS name, or WINS name in the **Host Name** attribute, then click **Next**.

Note: Hostnames and aliases cannot exceed 80 characters.

4. Select the server type and click **Next**.
5. Follow the instructions for configuring selected host type, then click **Finish**.

A host can also be added by using the **Console Configuration Wizard**. [“Accessing the Console Configuration Wizard” on page 420](#) provides information.

Deleting a host

You can delete a single host or multiple hosts within a folder.

To delete a host or hosts:

1. From the **Console** window, click **Enterprise**.
2. Right-click the host to delete, then select **Delete**. The **Deleting Host** dialog box appears.
 - To delete *multiple* hosts, select multiple hosts in the details pane and select **Delete**.
 - If additional copies of the host exist in the Enterprise, use the **Delete all existing copies of the host** option to delete all instances of that same host in a single operation.
3. Click **Yes** to confirm deletion of the host.

Copying a host

Multiple copies of a host can be created for a single NetWorker or Avamar server. For example, one copy of a host can be in its logical position in the Enterprise, while another copy of the host is in a Hosts-to-Watch folder where it can easily be monitored. This makes it possible to check the server without navigating through the Enterprise.

To copy a host:

1. From the **Console** window, click **Enterprise**.
2. Right-click the host to copy, then select **Copy**.
3. Right-click a new location, then select **Paste**.

Note: Also, the drag-and-drop feature can be used while holding down the **Ctrl** key to copy hosts.

Moving a host

To move a host from one location to another in an Enterprise:

1. From the **Console** window, click **Enterprise**.
2. Right-click the host to move, then select **Move**.
3. Right-click a new location, then select **Paste**.

Note: Also, use the drag-and-drop feature can be used to move hosts.

Managing folders in the enterprise

NetWorker software allows you to manage folders within the Enterprise. This means that folders can be added, renamed, deleted, and moved as needed.

New folders can be added directly beneath the Enterprise node or beneath other folders.

Adding a folder

To add a folder:

1. From the **Console** window, click **Enterprise**.
2. Right-click the location within the Enterprise where the new folder is to appear, then select **New>Folder**. A new folder appears in the Enterprise with the default name **Untitled1**.
3. Highlight the default name and type a new name to replace it. The name must meet these criteria:
 - Include at least one, but no more than 80 characters.
 - Exclude forward slashes (/).
4. Press **Enter**.

Deleting a folder

Note: If there are restrictions in place controlling which hosts a user is allowed to see, the folder might appear empty.

To delete a folder:

1. From the **Console** window, click **Enterprise**.
2. Right-click the folder to delete, then select **Delete**.
 - If hosts are present, a dialog box prompts you to confirm the deletion of each host. Select **Yes** to continue with the operation, or **No** to cancel it.
 - If no hosts are present, the folder is deleted.

If the folder contains any unique hosts (meaning hosts that do not have copies anywhere else in the Enterprise), an additional dialog box appears to confirm deletion of the unique host.

A separate dialog box with four options appears for each unique host in the folder:

- To delete the specified host, click **Yes**.
- To delete all hosts and subfolders in the selected folder, without further prompts, click **Yes to All**.
 - To cancel the deletion, click **No**.
 - To cancel any further deletion of hosts in the selected folder, and leave the remaining contents intact, click **Cancel**.

Non-unique hosts, and folders containing *only* non-unique hosts, are deleted without additional prompting.

Copying a folder

To copy a folder:

1. From the **Console** window, click **Enterprise**.
2. Right-click the folder to copy, then select **Copy**.
3. Right-click a new location, then select **Paste** and a copy of the folder appears in its new location.

Note: Also use the drag-and-drop feature can be used to copy folders while holding down the **Ctrl** key.

4. A folder cannot be copied within the same Enterprise level.

Moving a folder

To move a folder:

1. From the **Console** window, click **Enterprise**.
2. Right-click the folder to move, then select **Move**.
3. Right-click a new location, then select **Paste**. The folder appears in its new location.

Note: Also the "drag-and-drop" feature can be used to move folders.

Renaming a folder

To rename a folder:

1. From the **Console** window, click **Enterprise**.
2. Right-click the folder, then select **Rename**.
3. Highlight the folder name and type a new name to replace it. The name must meet these criteria:

- Include at least one, but no more than 80 characters.
 - Exclude forward slashes (/).
4. Press **Enter**.

Adding or deleting multiple servers by using a hostname file

For larger enterprises, it may be more convenient to add or delete multiple NetWorker servers by using the **gstmodconf** command and a hostname file. With this method, hosts are added or deleted at the base level of the Enterprise. The hosts are added as NetWorker managed nodes with the features Capture Events and Gather Reporting Data enabled. [“Using the gstmodconf command” on page 432](#) has more information about the **gstmodconf** command.

Restrictions

Copies of hosts cannot be added with the **gstmodconf** command. If a host already exists anywhere in the Enterprise (either at the base or within a folder), copies of it cannot be added by this command.

It is not possible to use this command to add a host to a folder. It can only add a host to the base level. After the host has been added, the graphical user interface can be used to move the host to a selected folder. [“Moving a host” on page 429](#) provides information about this procedure.

When the **gstmodconf** command is used for deletion, it deletes hosts from the base level. It does *not* delete hosts that are within folders.

Creating the hostname file

To add or delete multiple hosts at the same time, specify their names in a hostname file. The hostname file is a simple text file.

To create a hostname file, use these guidelines:

- ◆ Only one hostname may be listed on each line of the file.
- ◆ A non-comment line that contains more than one space-separated or tab-separated hostname generates an error.
- ◆ To include a comment in the file, start the line with a "#" character.
- ◆ Blank lines are treated as comments and ignored, as shown in [Example 33 on page 431](#):

Example 33 Hostname file

```
#This is a hostname file for XYZ Corporation
apple
banana
grape
kiwi
mango
nectarine
pineapple
strawberry
tangerine
```

Using the `gstmodconf` command

The `gstmodconf` command has this syntax:

```
gstmodconf -i file -f function -s server -k -p port -l login -P password
```

The *EMC NetWorker Command Reference Guide* or the UNIX man pages provide a complete description of the command and its options.

[Example 34 on page 432](#) shows how `gstmodconf` is used to add nodes from the file, `xyz_hostlist`. In this example, the Console server name is `myconsole` and the `xyz_hostlist` file contains:

Example 34 Adding multiple hosts with the `gstmodconf` command

```
apple
banana
grape
% gstmodconf -s myconsole -i xyz_hostlist
Trying 111.22.3.444... connected
processing file 'xyz_hostlist'
adding host 'apple'
successfully added host 'apple'
adding host 'banana'
successfully added host 'banana'
adding host 'grape'
successfully added host 'grape'
//Closing connection
```

Error messages generated by the `gstmodconf` command

[Example 35 on page 432](#) shows the error that is generated if `gstmodconf` is used to add a host that already exists in the Enterprise:

Example 35 Attempting to add a host that already exists

```
% gstmodconf -s myconsole -i xyz_hostlist
Trying 111.22.3.444... connected
processing file 'xyz_hostlist'
adding host 'apple'
///Error!
{
  string object_type = "gterror";
  int severity = 16;
  int reason = 23;
  list msg = {
    int level = 1;
    string text = 'Host name already exists';
  };
}
// Closing connection...
```

[Example 36 on page 432](#) shows the error that is generated if the `gstmodconf` command is entered *without* specifying the administrator password, when the password has been changed from its default value.

Example 36 Attempting to Use `gstmodconf` with an expired default password

```
% gstmodconf -s myconsole -i xyz_hostlist
Trying 111.22.3.444... auth failed.
gt_session_connect: clnt_create: Remote system error-Connection
refused.
```

Configuring a NetWorker server

To use the Administration window to modify a NetWorker server, the server must meet the following requirements:

- ◆ The server must be included in the Enterprise.
“Adding a managed host” on page 428 provides information about adding hosts to the Enterprise.
- ◆ The server must not restrict users from viewing the NetWorker server.

The Administration window can be used to modify an existing NetWorker server by specifying attributes in the Properties dialog box of the NetWorker server. The configuration of these attributes, such as setting the parallelism level or designating administrator privileges, can affect backup performance and security.

Set up the server

Note: When setting up the NetWorker server, be sure to enter the NetWorker product serial number. The product serial number is located on the Enabler Certificate that was sent when the NetWorker product was ordered.

To set up the NetWorker server:

1. From the **Administration** window, click **Configuration**.
2. Select the server name.
3. From the **File** menu, select **Properties**.
4. In the **Properties** dialog box, configure the appropriate attributes.
5. Click the **System Summary** tab and enter the product serial number for the server, as well as any other required information.
6. Click **Ok**.

Licensing the NetWorker server

The new for 7.6 Service Pack 1, NetWorker *Licensing Guide* provides information on how to license the NetWorker server.

Setting the Job inactivity timeout

Use the Job inactivity timeout attribute to specify the maximum time, in minutes that a job will be declared inactive and will be terminated since it has last been heard from the NetWorker server. This timeout applies to all processes throughout the entire runtime operation.

Note: The new Job inactivity timeout attribute applies to all processes throughout the entire runtime operation regardless of the job type and state. The savegrp inactivity timeout differs in that it only applies to save processes during a media session.

To set the Job inactivity timeout attribute:

1. In the **Administration** window, click **Configuration**.
2. In the left pane of the **Configuration** window, select the NetWorker server.
3. From the **File** menu, select **Properties**.
4. Select the **Configuration** tab.

5. For the **Job inactivity timeout** attribute, specify the maximum time in minutes that you want a job declared as inactive and terminated from the time it was last heard from.
6. Click **Ok**.

Configuring ConnectEMC

If ConnectEMC was selected during the installation of NetWorker 7.6, you will need to configure the program using NMC and the ConnectEMC Console on the 32-bit Windows system you specified as the location to install the ConnectEMC software. The ConnectEMC Console icon appears on the desktop of this system.

IMPORTANT

Ensure that the NetWorker server and ConnectEMC host name are resolved with short name and fully qualified domain name (FQDN) prior to running ConnectEMC. You must be able to ping all hosts by IP address, short name and FQDN name. If not, installing ConnectEMC fails and the NetWorker/ConnectEMC send home feature fails.

The ConnectEMC for Windows User Guide, available on Powerlink from **Support > Technical Documentation and Advisories > Software ~ C ~ Documentation > ConnectEMC**, provides more instructions for configuring ConnectEMC.

Configure ConnectEMC in the ConnectEMC Console

To configure ConnectEMC in the ConnectEMC Console:

1. Double-click the **ConnectEMC Console** desktop icon. If the message “Invalid callhome config file” appears, click **Ok** to continue.
2. When the Console appears, the left side of the button menu contains an octagonal **STOP** icon. If the icon is red, click the **STOP** icon.
3. In the left pane, click the [+] box next to **Connection** and select **General**.
4. From the **Connection** menu, select **Add Connection > Email Connection** from the list box.
5. In the **Email** window, enter the following values:

In the Connection settings section:

- **Recipient** — **emailalert@emc.com**
- **EMail Server Hostname/IP** — The name or IP address of the local SMTP server that supports SMTP relaying.
- **Sender** — The administrator's email address

In the General Settings section:

- **Alert Type** — Select **Use this connection first**
- **Email Type** — Select **ACSII**

All other values — Leave as default values

6. Click **Test** to send a test email to the ConnectHome server. Verify that the email was sent successfully.
7. Click **Save**.

8. The left side of the menu contains a green octagonal **Run** icon.
9. Click the **Run** icon.
10. From the menu, select **File > Exit**.

(Optional) Resetting the EMC Polling Interval

The Polling Interval by default is set to 5 seconds. If you want to reset the ConnectEMC Polling Interval, while still in the ConnectEMC Console and with the ConnectEMC service set to Stop, perform the following:

1. In the far left pane, click the **Settings** folder.
2. Click **General**. **POLL_INTERVAL** should display in the right pane under **Variable Name**.
3. In the **Setting Value** column for the **POLL_INTERVAL**, type an interval value in seconds (for example, type **60** for a 1 minute interval).
4. Select the floppy disk icon on the left side of the menu to save changes.
5. If necessary, restart the ConnectEMC service (see [step 8](#) above).

Configure ConnectEMC in NMC

After configuring the settings for ConnectEMC using the ConnectEMC console, some tasks need to be performed in the NetWorker Management Console. These tasks are:

- ◆ Specifying the name of the ConnectEMC host
- ◆ Setting Autostart to run nsrconnect

Name of the ConnectEMC host

When ConnectEMC is installed, the host is set to the NetWorker server by default, if no host was specified during installation.

To set or verify the name of the ConnectEMC host:

1. Launch NMC.
2. Click the **Configuration** button. An entry for ConnectEMC appears in the tree of the left navigation pane.
3. Click **ConnectEMC**. In the ConnectEMC window pane, right-click **DefaultConnectEMC** and select **Properties**.
4. In the ConnectEMC host field, type the name of the host that will be used to run the ConnectEMC daemon if the host specified is not correct.

Configure ConnectEMC to send

To configure ConnectEMC to send:

1. Connect to the NetWorker server using NMC.
2. Click the **Configuration** button. An entry for ConnectEMC appears in the tree of the left navigation pane.
3. Click **ConnectEMC**. In the ConnectEMC window pane, right-click **DefaultConnectEMC** and select **Properties**.
4. Confirm that the correct NetWorker server is specified in the ConnectEMC Host field.
5. Select **Enabled** from the Autostart drop-down menu.

6. Click **Ok**.

Setting Autostart to run nsrconnect

nsrconnect is the NetWorker interface to ConnectEMC. The nsrconnect task is run to create the .xml file that contains the system configuration information stored in the RAP database. When Autostart is set to Enabled, nsrconnect will be launched one day after the NetWorker server is started (or restarted), and once per month thereafter. For example, if the NetWorker server (nsrd) is started on Monday, nsrconnect launches on Tuesday, and then again a month from Tuesday.

To start the nsrconnect task immediately, set AutoStart to Start now.

IMPORTANT

Start Now can only be initiated on the server once every 15 minutes due to the 15 minute throttle limit.

Configure NetWorker to pass contact information to Connect Home server

In order to quickly and accurately identify the source of server information, provide the company contact information:

1. Right-click the NetWorker server in the navigation pane, and select **Properties**.
2. Click the **Customer Information** tab.
3. Complete the following fields:
 - Contact Name
 - Company
 - Street Address
 - City/Town
 - State/province
 - Zip/postal code
 - Country
 - Phone Number
4. Click **Ok**.

Enabling BMR server support

Connection with a HomeBase Server is enabled during the set up of the NetWorker server. This connection enables the delivery of profile data from the NetWorker client to the HomeBase Server.

[“Configuring a client for BMR support” on page 657](#) provides information for configuring and enabling a BMR client.

Parallelism and multiplexing

Parallelism is a general term within the NetWorker software for a number of configurable options that allow you to adjust the volume of data being processed by the system, thereby improving performance of servers, storage nodes, and devices. Multiplexing is the ability to write multiple save streams simultaneously to the same

storage device. This section identifies attributes related to parallelism and multiplexing and describes how they work together to optimize your NetWorker environment.

Parallelism

Several attributes in various NetWorker resources are used to adjust the volume of data being processed by the system to improve overall performance.

The following attributes are related to parallelism:

- ◆ Client parallelism
- ◆ Server parallelism
- ◆ Savegrp parallelism
- ◆ Max active devices
- ◆ Media library parallelism

These attributes are described in detail in the following sections.

Client parallelism

Client parallelism is defined by using the Parallelism attribute of the Client resource, found in the NetWorker Console on the Globals (1 of 2) tab of the Client property dialog box.

Client parallelism defines the number of save streams that a client can send simultaneously during backup. Client parallelism has two default values, depending on whether the Client resource is a NetWorker server:

- ◆ For the Client resource for a NetWorker server, the default value for the client parallelism attribute is 12. This higher default value allows the server to complete a larger number of index backups even while the server's filesystem or other index backups are still running.
- ◆ For all other clients (that is, clients that are not also NetWorker servers), the default value is 4. Many features within NetWorker, such as deduplication, NDMP backups, and VSS, will not work correctly with client parallelism set to a value that is higher than 4.

For all clients other than the Client resource of the NetWorker server, to avoid disk contention, you should generally not set the client parallelism higher than the number of physical disks involved in the client's backup, along with, on Microsoft Windows systems, the System State and System DB. Therefore, a typical Windows system configured with the ALL keyword for the client save set attribute will back up the C: and D: drives as well as the System State and System DB; in this case the default parallelism setting of 4 will be adequate. On the other hand, if you define multiple save sets on the same disk (C:\users, C:\system, C:\docs and so on), higher client parallelism will result in multiple save streams attempting to access the disk at the same time.

Server parallelism

Server parallelism is defined by using the Parallelism attribute of the Server resource, found in the NetWorker Console on the Setup tab of the Server property dialog box.

Server parallelism defines the number of simultaneous save streams supported by the server. The default and the maximum allowed server parallelism varies depending on the edition of NetWorker software. Each enabled storage node

connected to the NetWorker server can increase the parallelism maximum. The maximum parallelism for any NetWorker server and storage node combination can vary. The *EMC NetWorker Release Notes* provides more information.

Optimally, your NetWorker server should be configured to process enough save streams to keep all backup devices in your datazone writing at their maximum speed. By tuning the server parallelism setting, along with other settings discussed in this section, you can maximize the speed that data is written to backup devices.

Savegroup parallelism

Savegroup parallelism is defined by using the Savegrp parallelism attribute of the Group resource, found in the NetWorker Console on the Advanced tab of the group property dialog box.

Savegroup parallelism determines the number of simultaneous save streams that will be allowed for a NetWorker group. The default value for this attribute is 0, which means that the attribute will have no effect on other parallelism settings. If the value is greater than zero, it will override any other parallelism considerations that savegrp would use.

Savegroup parallelism can help tune backups that involve multiple groups that overlap in their backup schedules, particularly if one group has a large number of clients. For example, if you have one group with 100 clients and another group with 4 clients, and you have the Savegrp parallelism attribute set to 0, savegrp may start as many clients in the first group as possible, up to the maximum number allowed by the server's server parallelism setting. This will mean that the smaller group will not be able to start any client backups, because the server parallelism is at its maximum, and the smaller group may experience timeouts and backup failures. To avoid this situation, you can set the savegroup parallelism for the larger group to a number below the server's server parallelism setting, guaranteeing that the clients in the smaller group will be able to begin their backups.

Max active devices

The maximum number of active devices for a storage node is defined by using the Max active devices attribute of the Storage Node resource, found in the NetWorker Console in the Devices window, on the General tab of the Storage Node property dialog box.

This attribute sets the maximum number of devices that the NetWorker software may use from the storage node. In large environments with media libraries with large numbers of devices, it is possible that the storage node will not have the ability to optimize all drives in the library. The Max active devices attribute allows you to limit the number of devices that the storage node will use at a given time, thereby allowing the storage node to have access to all devices in the library but limiting it to the number of devices it can fully optimize.

Media Library parallelism

Media library parallelism is defined by using the Max parallelism attribute of the Library resource, found in the NetWorker Console in the Devices window, on the Configuration tab of the Library property dialog box.

Media library parallelism allows you to designate the maximum number of available devices for the following autochanger operations:

- ◆ Inventorying volumes
- ◆ Labeling volumes

The Max parallelism attribute of the Library resource is normally set to one less than the number of devices within the library.

Library operations that operate on multiple volumes are more efficient if multiple devices can be used in parallel for these operations. However, because libraries may be performing multiple operations simultaneously, you may wish to restrict the number of devices available for inventorying and labeling operations, to leave some devices available for other library operations.

Multiplexing

Multiplexing is the ability to write multiple save streams simultaneously to the same storage device. It is often more efficient for the NetWorker server to multiplex multiple save sets to the same device; there are also times when limiting the number of save streams to a particular device will improve performance of your NetWorker environment.

The NetWorker software has several attributes that can be used to increase or limit the number of save streams being written to a device.

The following attributes are related to multiplexing:

- ◆ Target sessions
- ◆ Max sessions
- ◆ Pool parallelism

These attributes are described in detail in the following sections.

Target sessions

The optimal number of target sessions per device is defined by using the Target sessions attribute of the Device resource, found in the NetWorker Console in the Devices window, on the Configuration tab of the Device property dialog box.

The Target sessions attribute allows you to set the optimal number of backup sessions accepted by an active device. This is not a hard limit; to set a hard limit for the number of sessions to a particular device, use the Max sessions attribute, described below.

Instead of a hard limit, the Target sessions attribute aids in load balancing for devices by determining when the NetWorker software should begin writing save streams to another device:

- ◆ If a device is already receiving the number of backup sessions determined by the target sessions value, the NetWorker server uses the next underutilized device for the backups.
- ◆ If all available devices are receiving the number of backup sessions determined by their target sessions value, the NetWorker server overrides the set value and uses the device with the least activity for the next backup session.

Because it is often more efficient for the NetWorker server to multiplex multiple save sets to the same device, rather than write each save set to a separate device, the NetWorker server attempts to assign to each device a number of save sets, up to the value of target sessions, before assigning a save set to another device.

Note: When the NetWorker software assesses how many devices need to be involved in multiple savestreams assignments with the same storage node, the device with the lowest target session value is used as a reference. It does not make a difference if the device with the lowest target session value is associated with a different pool than the incoming savestreams.

Max sessions

The maximum number of target sessions per device is defined by using the Max sessions attribute of the Device resource, found in the NetWorker Console in the Devices window, on the Configuration tab of the Device property dialog. This attribute defines the maximum number of save sessions for a device. Its value is never less than the target sessions value.

Pool parallelism

Pool parallelism is defined by using the Max parallelism attribute of the Pool resource, found in the NetWorker Console in the Media window, on the Configuration tab of the Pool property dialog box.

Pool parallelism determines the maximum number of simultaneous save streams for each device belonging to a NetWorker pool. The default value for this attribute is 0, which means that the attribute will have no effect on other parallelism settings.

Pool parallelism can be used to increase recovery times. For example, you can create a pool for backups of business critical data and use this attribute to restrict the number of save sets written in parallel to the media for this pool, which will increase the speed that data is recovered from that media. However, be aware that if the Max parallelism attribute of the pool is set to 1, there may be a prolonged delay between the backup of save sets. If this behavior occurs, try increasing the Max parallelism attribute for the pool resource.

Managing server access

NetWorker server access is managed by granting access privileges to NetWorker Console users.

Granting access to manage NetWorker servers from Console server

If the Console server and the NetWorker server are installed on separate hosts, the Console administrator must be granted access to administer and monitor the target NetWorker server. To grant access, use the **nsraddadmin** command from the command prompt on the NetWorker server. Grant access on each NetWorker server that is to be managed from the Console server. The *NetWorker Installation Guide* provides information about granting access with the **nsraddadmin** command. The *EMC NetWorker Command Reference Guide* or the UNIX man pages provides information about the **nsraddadmin** command.

Administrator privileges

Use the Administration window to grant NetWorker administrator privileges to additional Console users. This is done by adding users to the Administrators group for the NetWorker server. [“NetWorker User Groups” on page 442](#) provides more information.

When granting privileges to users, note the following requirements:

- ◆ To change security settings, the user must be a member of the NetWorker Administrators group.
- ◆ To perform a scheduled backup of SYSTEM and VSS SYSTEM save sets, the user must be a member of the NetWorker Administrators group.

- ◆ To add to or change the configuration of the server, media devices, and media libraries, the user must have the Configure NetWorker privilege.

NetWorker software ships with default administrator settings that give root users on UNIX and Linux, and members of the Windows Administrators group on Windows, permission to change its configurations. The Administrators group in the Server resource should include the following entries, depending on the platform of the client trying to administer the NetWorker server:

- ◆ Microsoft Windows:
user=administrator, host=server_name
- ◆ UNIX and Linux:
user=root, host=server_name

Note: If a hostname is used, the NetWorker server must be able to convert the hostname to a resolved TCP/IP address.

Additional Console users or user groups can be granted administrative privileges by adding them to the Administrators group.

Username should be listed in the form of name/value pairs by using the syntax:

```
name=value[, name=value, ...]
```

where *name* can be one of the following:

- ◆ user
- ◆ group
- ◆ host
- ◆ domain
- ◆ domain_sid
- ◆ domaintype (either NIS or WINDOMAIN)

For example, to grant administrative privileges to a user that is named *jdoe* on the host named *jupiter*, enter this line in the Users attribute:

```
user=jdoe, host=jupiter
```

Note: The formats *user@host*, *host/user*, and similar formats are supported, but are ambiguous as to whether host or domain is intended. As a result, the *name=value* format is preferred.

If the value has spaces, it should be surrounded by quotation marks, for example:

```
domain="Domain Admins"
```

You can also enter just a username, which allows that user to administer NetWorker from any host (this is the same as an entry of *user=username*). Wildcards can also be used in place of a value. However, wildcards should be used with caution because they can compromise your enterprise security. Netgroup names can also be entered but must be preceded by an ampersand (&).

Example 37 Using the NetWorker Administrators Group

This example shows what to enter to provide NetWorker administrative privileges to the following:

- ◆ The user *root* from any host

- ◆ The user *operator* from the hosts *mars* and *jupiter*
- ◆ Any users, valid hosts for the users, and valid domains for the users and host that are included in the netgroup *netadmins*:

```
user=root
user=operator,host=jupiter
user=operator,host=mars
&netadmins
```

Microsoft Windows groups and NetWorker administrative privileges

The NetWorker server recognizes domain names and Microsoft Windows groups, both local and global. For example:

- ◆ Administrators group
- ◆ Domain Admins group

If you are logged into a domain, only the *global* group is recognized. You can find out the name of your group by running the Windows utility **findgrp.exe**, which is available with the Windows Resource Kit.

If you are logged into an individual Windows computer, only the *local* group is recognized, because there is no global group.

In cases where a user belongs to a domain that cannot be contacted by the server and therefore the username cannot be verified, you can use a more specific user description to guarantee that the appropriate user will have administrative rights to the server. The syntax for this user description is as follows:

- ◆ Single user:

```
user=user_name, domain=domain_name
```

For example:

```
user=joe,domain=NT-ENG
```

- ◆ Group:

```
group=group_name, domainsid=domain_id
```

For example:

```
group=Administrators,domainsid=S-1-5-32-323121-123
```

NetWorker User Groups

NetWorker includes an access control feature that is configured through the User Group resource. This feature allows NetWorker administrators to create user groups, define the privileges associated with those user groups, and assign users to various groups. Privileges include such things as permission to monitor NetWorker software, as well as to back up and recover local data.

To create user groups, you must have an Access Control enabler installed on the NetWorker server. One enabler per datazone is required. This feature is available only on servers with NetWorker release 7.0 and later.

Preconfigured User Groups

NetWorker comes with two preconfigured user groups:

- ◆ Administrators

◆ Users

Administrators

Members of the Administrators group have permission to perform all NetWorker functions, except with regard to some utilities that require root or Microsoft Windows Administrator access. The UNIX root user and members of the Microsoft Windows Administrators group are always members of this group and cannot be removed from the group. The *EMC NetWorker Command Reference Guide* or the UNIX man pages provide information on the permission requirements for a specific utility.

Privileges associated with the Administrators group cannot be changed.

Users

By default, members of the Users group are granted permission to back up and recover local data and to monitor NetWorker operations. They cannot view or edit configurations.

Customizing privileges

The privileges associated with the Users group can be customized to fit your requirements. Privileges associated with the Administrators group cannot be edited. [Table 84 on page 443](#) lists these preconfigured privileges and their associated permissions.

Table 84 User Group privileges (1 of 2)

Privilege	Permissions
Change security settings	<p>Allows group members to edit these resources and attributes:</p> <ul style="list-style-type: none"> • User Group resources • Remote Access attribute in the Client resource • Archive Users attribute in the Client resource • Administrators attribute in the Server resource • Notification resource • Owner Notification attribute in the Client resource <p>Note: If you change the users listed in the Administrator attribute of the Server resource, the changes are automatically reflected in the Administrators group as well. Similarly, if you change the members of the Administrators group, the changes are automatically reflected in the Administrator attribute.</p> <p>Members of groups with this privilege can grant access to restricted functions to any user. User groups with this privilege must also have these privileges: Configure NetWorker, Operate NetWorker, Monitor NetWorker, Operate Devices and Jukeboxes, Backup Local Data, and Recover Local Data.</p>
Remote access all clients	<p>Allows group members to remotely browse and recover data associated with any client, as well as view configurations for all Client resources. This privilege is required to perform Directed Recovers. This privilege supersedes the Remote Access attribute in the Client resource.</p> <p>User groups with this privilege must also have these privileges: Operate NetWorker, Monitor NetWorker, Operate Devices and Jukeboxes, Backup Local Data, and Recover Local Data.</p>
Configure NetWorker	<p>Allows group members to configure resources associated with the NetWorker server, its storage nodes, and clients. This includes creating, editing, and deleting resources.</p> <p>Users with this privilege cannot configure User Group resources or the Remote Access or Archive Users attributes in the Client resource. Permission to change these settings is granted only through the Change Security Settings privilege.</p> <p>User groups with this privilege must also have these privileges: Operate NetWorker, Monitor NetWorker, Operate Devices and Jukeboxes, Backup Local Data, and Recover Local Data.</p>

Table 84 User Group privileges (2 of 2)

Privilege	Permissions
Operate NetWorker	<p>Allows group members to perform NetWorker server operations. For example, members can:</p> <ul style="list-style-type: none"> Reclaim space in a client file index. Set a volume location or mode. Start or stop a savegroup. Query the media database and client file indexes. <p>User groups with this privilege must also have these privileges: Monitor NetWorker, Operate Devices and Jukeboxes, Backup Local Data, and Recover Local Data.</p>
Monitor NetWorker	<p>Allows group members to:</p> <ul style="list-style-type: none"> Monitor NetWorker operations, including device status, save group status, and messages. View media databases information. View NetWorker configuration information (except the security settings described in the Change Security Settings privilege). <p>This privilege is not required to back up and recover local data, although it may be helpful for users to monitor messages and other information.</p>
Operate devices and jukeboxes	<p>Allows group members to perform device and autochanger operations, for example, mounting, unmounting, and labeling. Users with this privilege can also view device status and pending messages, as well as view information in the media database.</p> <p>User groups with this privilege must also have Monitor NetWorker privileges.</p>
Recover local data	<p>Allows group members to recover data from the NetWorker server to their local client, as well as view most attributes in the client's configuration. Members can also query the client's save sets and browse its client file index.</p> <hr/> <p>Note: This privilege does not provide permission to view information about other clients.</p> <p>This privilege does not override file-based permissions. Users can only recover files with the appropriate user permissions for that operating system.</p> <p>User with the privilege still must be logged in as root (UNIX) or administrator (Microsoft Windows) to perform save set or NDMP recovers.</p> <hr/>
Backup local data	<p>Allows group members to manually back up data from their local client to the NetWorker server, as well as view most attributes in the client's configuration. Members can also query the client's save sets and browse its client file index. This privilege does not provide permission to view information about other clients.</p> <hr/> <p>Note: This privilege does not override file-based permissions. Users can only back up files with the appropriate user permissions for that operating system.</p> <p>Users with the privilege still must be logged in as root (UNIX) or administrator (Microsoft Windows) to run the savegrp command or perform NDMP backups.</p> <p>To allow scheduled backups to operate correctly, the root user (UNIX) or administrator (Microsoft Windows) on the client has this privilege automatically.</p> <hr/>

Working with User Group resources

This section provides procedures for creating, editing, copying, and deleting a User Group resource.

Creating a User Group resource

To create a User Group resource:

1. From the **Administration** window, click **Configuration**.

2. Right-click **User Groups**, then select **New**. The **Create User Group** dialog box appears.
3. In the **Name** attribute, enter the name of the **User** group. The optional **Comment** attribute can be used to enter a description of the **User** group.
4. In the **Users** attribute, enter the names of the users that should be members of the user group by using the format described in [“Administrator privileges” on page 440](#).
5. Select the privileges to assign to the user group.
6. Click **Ok**.

Editing a User Group resource

To edit a User Group resource:

1. From the **Administration** window, click **Configuration**.
2. Click **User Groups**.
3. Right-click the user group to edit, then select **Properties**. The **Properties** dialog box appears.
4. Make any necessary changes, then click **OK**.

Note: You cannot change the privileges associated with the Administrators group. Also, you cannot remove the UNIX root user or the Windows Administrator for the server being configured.

Copying a User Group resource

To copy a User Group resource:

1. From the **Administration** window, click **Configuration**.
2. Click **User Groups**.
3. Right-click the user group to copy, then select **Copy**. The **Create User Group** dialog box appears, and contains the same information as the user group that was copied, *except* for **Name** attribute.
4. In the **Name** attribute, enter a name for the new user group.
5. Edit any other attributes as appropriate, then click **OK**.

Deleting a User Group resource

Note: You cannot delete a preconfigured user group.

To delete a User Group resource:

1. From the **Administration** window, click **Configuration**.
2. Click **User Groups**.
3. Right-click the user group to delete, then select **Delete**.
4. When prompted, click **Yes** to confirm the deletion.

Server communication issues within Microsoft Windows

This sections addresses various client/server communication issues that occur when running NetWorker software in a Microsoft Windows environment.

Hostname determination

NetWorker software on a Windows server gets its hostname from its TCP/IP setup. This name is not necessarily the same computer name that is common to other Windows applications.

To determine the hostname of a Windows computer, type the following at a command prompt.:

```
hostname
```

Name resolution

If the network consists of only Microsoft Windows computers, you may find WINS or LMHOSTS is adequate for using NetWorker software. However, when using the software with clients running on other platforms, such as UNIX, you must use a local host file or DNS name resolution.

You must add the NetWorker server name to either the local hosts file (located in %SystemRoot%\system32\drivers\etc) or the Domain Name Server that contains the names of all servers on your network.

Backup Operators group

The Microsoft Windows Backup Operators local group provides its members the permissions necessary to back up and recover data from a Windows computer. Users who request backups must be in the Backup Operators or Administrators group of the domain into which they are logged. The Backup Operators group is assigned on a computer-by-computer basis, rather than globally by the domain. If you are having trouble performing tasks on one NetWorker server but not another, check Backup Operators group on the problematic computer to ensure that you are properly assigned.

Dynamic Host Configuration Protocol

A NetWorker server requires a static (fixed) hostname address. Typically, addresses for Dynamic Host Configuration Protocol (DHCP) clients change because they use dynamic addressing. If the address changes, the authorization code for that NetWorker server becomes invalid. If the NetWorker server is a DHCP client, a static TCP/IP address for the server must be preserved. NetWorker clients can still use dynamic addressing.

Backup and Recover Server service

In Microsoft Windows operating systems, the NetWorker Backup and Recover Server service is normally started by the Windows System account. This allows backup and recovery services to run even if no one is logged onto that computer.

Notifications

A notification provides information about events that occur in a NetWorker environment. You can configure the events to be reported, as well as how the NetWorker server reports them to you. Specific programs can be executed when an event occurs, including third-party programs. By default, the NetWorker server sends notifications to log files located in the <NetWorker_install_dir>\logs directory.

Preconfigured notifications

NetWorker is preconfigured to provide most of the notifications required to monitor NetWorker events. [Table 85 on page 447](#) lists these preconfigured notifications and the associated actions performed by the NetWorker server.

Table 85 Preconfigured notifications (1 of 2)

Notification	Action performed by the NetWorker server
Bootstrap	Sends the bootstrap information to the default printer of the NetWorker server.
Bootstrap backup failure	Sends this email to root/Administrator: Bootstrap backup failed.
Cleaning cartridge expired	Windows: Reports expired cleaning cartridge to the media log file. UNIX: Sends this email to root: replace the expired cleaning cartridge.
Cleaning cartridge required	Windows: Reports the need for cleaning cartridge to the media log file. UNIX: Sends this email to root: insert a cleaning cartridge.
Client install	Windows: Reports hostname and NetWorker client software version information to the media log file. UNIX: Sends this email to root: host <i>host_name</i> installed <i>product_version</i> . Where <i>host_name</i> is the name of the NetWorker host, and <i>product_version</i> is the NetWorker client software release and build number.
Device cleaned	Windows: Reports that a device has been cleaned to the media log file. UNIX: Sends this email to root: device cleaning is complete.
Device cleaning required	Windows: Reports that a device requires cleaning to the media log file. UNIX: Sends this email to root: clean the device.
Device disabled	Windows: Reports that a device has been automatically disabled to the media log file. UNIX: Sends this email to root: a device has been automatically disabled.
Device serial number mismatch	Windows: Reports that a device ordering error has occurred, and moves the device to service mode. UNIX: Sends this email to root: Check system device ordering. Moving device to service mode. To correct, scan for devices in NMC and re-enable the device.
Event log (Windows only)	Logs notification events triggered by events and priorities to the Event Log.
Filesystem full - recovering adv_file space	Launches the nsrim program to remove aborted and expired save sets. Used with advanced file type devices only.
Filesystem full - waiting for adv_file space	Windows: Reports that the advanced file volume is full to the media log file. UNIX: Sends this email to root: advanced file volume is full.
Index size	Windows: Sends a message about the status of the index to the index log file. UNIX: Sends this email to root: check the size of the client file index because it will soon exceed the space available.

Table 85 Preconfigured notifications (2 of 2)

Notification	Action performed by the NetWorker server
Log default	<p>Windows: Sends data about NetWorker events to the messages log file.</p> <p>UNIX: Directs the UNIX syslog facility (/usr/bin/logger) to log information from the /nsr/logs/messages file into the appropriate system log file.</p> <p>SuSE Linux: System log notifications might fail on SuSE Linux Enterprise Server 8 and 9. The logger binary appears in the /bin directory instead of /usr/bin. This causes the Log default notification to fail.</p> <p>To resolve this issue:</p> <ul style="list-style-type: none"> Create a link in the /usr/bin directory to /bin/logger. <p>Note: The default Tape Mount Request 1 and Tape Mount Request 2 notifications must be updated if a link is not created.</p> <ul style="list-style-type: none"> Modify the Log Default notification and change the /usr/bin/logger filepath to /bin/logger.
NetWorker Daemons Not Running	Sends this email to root/Administrator: NetWorker daemons not running.
New Virtual Machine	<p>Windows: Sends message that new virtual machines have been detected to the messages log file.</p> <p>UNIX: Sends e-mail that new virtual machines have been detected.</p>
Registration	<p>Windows: Sends messages about the registration status of your NetWorker products to the messages log file.</p> <p>UNIX: Sends this email to root: check the registration status.</p>
Resource File Corruption	Sends this email to root/Administrator: Resource file corruption.
Savegroup completion	<p>Windows: Reports the success of client save sets to the savegrp log file.</p> <p>UNIX: Sends this email to root: degree of success in completing scheduled backups, cloning, and archive operations.</p>
Save set marked suspect	Sends this email to root/Administrator: Save set marked suspect.
SNMP notification request	Sends event notifications to a network management console (this notification only appears if the NetWorker SNMP module has been purchased and enabled). Chapter 21, "SNMP Module" provides details on SNMP notifications
Storage Node Registration	Registers a client as a storage node.
Tape mount request 1	<p>Windows: Requests media be mounted in a device and displays a pending message.</p> <p>UNIX: Sends a request to the messages file to mount a backup volume, using a priority of Waiting.</p>
Tape mount request 2	<p>Windows: Requests media be mounted in a device and displays a pending message.</p> <p>UNIX: Sends a request to the messages file to mount a backup volume, using a priority of Critical.</p>
Tape mount request 3	<p>Windows: Sends a request for mounting a backup volume, using a priority of Alert, to the media.log file.</p> <p>UNIX: Sends an email to root to request that the tape be mounted.</p>
Tape mount request 4	Sends an email to root/Administrator to request that the tape be mounted.
Verify Label failed on unload	Sends an email to root/Administrator: Unable to read the tape label.
Volume Marked full	Sends an email to root/Administrator: Volume marked full.

Customizing notifications

Notifications require the following three elements:

- ◆ “Events” on page 449
- ◆ “Actions” on page 450
- ◆ “Priorities” on page 451

Events

Table 86 on page 449 lists the events that trigger a notification.

Table 86 **Events**

Event	Description
adv_file	The file system is full and is waiting for additional space.
Bootstrap	The bootstrap backup failed.
Cleaning cartridge expired	A cleaning cartridge has expired and needs replacing.
Cleaning cartridge required	Mount the cleaning cartridge.
Client	NetWorker client software has been installed on a host.
Deleted media	A media device has been deleted.
Device cleaned	A device has been cleaned.
Device cleaning required	A device requires cleaning.
Device disabled	A device has been automatically disabled.
Hypervisor	New virtual clients have been auto-discovered, or auto-discovery failed.
Index attention	An index needs attention.
License expiration	A license has expired.
Media	A media related event occurred. For example, a volume may require mounting.
Media attention	Media needs operator attention to mount or unmount backup volumes.
Media capacity	A volume has almost reached the maximum number of save sets allowed in the media database.
Media request	Media needs operator attention to mount backup volumes.
Potential device ordering issue	A device ordering or serial mismatch error has occurred.
Registration	Product registration needs attention.
Savegroup	A backup group has completed the backup.
Server	Other server events (for example, restarting the NetWorker server).
Storage node	A storage node has been installed.
Write completion	A write operation is complete.

Actions

Table 87 on page 450 lists the actions that the server takes after an event notification occurs.

Table 87 Actions

Action	Description
eventlog	(Windows only) Logs the notification message to the event log.
nsrlog	(Windows only) Sends a message about an event to a file.
nsrlpr	(Windows only) Prints information to a printer. “Using nsrlpr to print notifications” on page 450 provides more information about using nsrlpr .
logger	(UNIX only) Uses the UNIX syslog facility (/usr/bin/logger) to log information or send messages.
lp	(UNIX only) Prints the notification.
mail	(UNIX only) Sends email to the specified user.
nsrtrap	Sends notifications to an SNMP management console.

Third-party programs can also be used for the action, as long as the programs support reading from *standard input*. For example:

- ◆ With UNIX systems, you can use a third-party email program rather than the **mail** command.
- ◆ With Windows systems, you can use a third-party email program to send the information to other locations, such as an email address or pager system.

Only users who belong to the NetWorker server Administrators group, or users with the Change Security Settings privilege, can change the Action attribute of an existing notification.

Using nsrlpr to print notifications

NetWorker Server, on Windows systems only, looks at the printer named in each of these two sources to determine which to use to print notifications with **nsrlpr**:

- ◆ The Printer attribute in the Group resource. This entry is ignored if a printer is named in the Action attribute for a notification.
- ◆ The printer named in the Action attribute for a notification, or that you specified by using the **-P** option of the **nsrlpr** command.

Designating a printer for a Notification Resource

To designate a printer for a Notification resource:

1. From the **Administration** window, click **Configuration**.
2. Click **Notifications**.
3. Right-click a notification, then select **Properties**. The **Properties** dialog box appears.
4. In the **Action** attribute, type:

```
nsrlpr -P printer_name
```

where *printer_name* is the name of the designated printer.

If the printer name has spaces, such as *eng printer one*, then enclose the printer name in double quotes, as shown here:

```
nsrlpr -P "eng printer one"
```

If the printer is associated with a particular server, as is the case with Microsoft LAN Manager printers, use this syntax:

```
nsrlpr -P \\server_name\printer_name
```

where:

- *server_name* is the name of the server to which the printer is attached.
- *printer_name* is the name of the printer to use.

Send the bootstrap notification printout to its group's printer

To send the bootstrap notification printout to the printer defined in the **Printer** attribute of the **Group** resource:

1. From the **Administration** window, click **Configuration**.
2. Click **Notifications**.
3. Right-click **Bootstrap**, then select **Properties**. The **Properties** dialog box appears.
4. In the **Action** attribute, type:

```
nsrlpr -P %printer
```

Testing the nsrlpr program

To test the **nsrlpr** program, enter this at the command prompt:

```
nsrlpr -P printer_name text_file
```

where:

- ◆ *printer_name* is the name of the printer to use.
- ◆ *text_file* is the name of a text file to print.

The printer name was typed incorrectly if you receive this error message:

```
Error: print server did not accept request. Job aborted.
```

Once you can print from the command prompt, enter this command to change the Action attribute to the print command:

```
nsrlpr -P printer_name
```

Note: Print jobs sent by the NetWorker Backup and Recover Server service run in the Local System context. Under certain conditions, it may not have access to network print queues. Microsoft Knowledge Base articles 132679 and 143138 on the Microsoft website provide more information.

Priorities

Each NetWorker event has a series of associated messages, and each message has an associated priority. The preconfigured notifications have selected priorities based on the importance of the message being sent. For example, the first time the NetWorker server sends a mount backup volume request, the priority assigned to the message is Waiting. The priority of the second request is Alert. The priority of the third request is Critical.

Table 88 on page 452 lists the priorities upon which notifications are based.

Table 88 **Priorities**

Priority	Description
Information	Information about the current state of the server.
Notice	Important information.
Warning	A non-fatal error has occurred.
Waiting	The NetWorker server is waiting for an operator to perform a routine task, such as mounting a backup volume.
Alert	A severe condition exists that requires immediate attention.
Critical	The server detected an error that should be fixed.
Emergency	A condition exists that may cause NetWorker to fail unless corrected immediately.

Note: Event priorities are sorted alphabetically, rather than by severity.

Logging event notifications

NetWorker keeps two general notification log files. By default, these files are located in <NetWorker_install_dir>\logs.

- ◆ messages log file

The data in the messages log file is generated by nsrlog, which is part of the NetWorker event notification mechanism. The nsrlog program is triggered by a notification, and it prints the file to the messages log file.

- ◆ daemon log file

The nsrd, nsrexecd, and their subordinate processes redirect their output to the daemon log file.

“Viewing log files” on page 663 provides information about viewing log files.

To better access and use these event logs on Windows systems, an Event Logging mechanism enables applications to log messages to the application event log, and access them from any computer that has the Windows Event Viewer. The Event Viewer enables you to look selectively at the messages that interest you by filtering messages based on the categories listed in Table 89 on page 452.

Table 89 **Event Viewer messages**

Event Viewer category	Displayed information
Source	Events from NetWorker software always designate NetWorker as the source.
Category	Mapped from NetWorker notification event type (savegroup, server, registration, and so on).
Severity	Mapped from NetWorker notification priority: <ul style="list-style-type: none"> • Critical and Emergency are mapped to Error. • Priorities between Alert and Warning are mapped to Warning. • Notification and Information are mapped to Information.
Event ID	Events from NetWorker software always designate the numeral 1 for the ID.

Creating a custom notification

NetWorker also provides preconfigured notifications. [“Preconfigured notifications” on page 447](#) provides a complete list of preconfigured notifications.

To create a custom notification:

1. From the **Administration** window, click **Configuration**.
2. Right-click **Notifications**, then select **New**. The **Create Notification** dialog box appears.
3. In the **Name** attribute, enter a name for the notification.
4. In the **Event** attribute, select the events to be acted on.
5. In the **Priority** attribute, select the priorities of the corresponding actions.
6. In the **Action** attribute, enter a command to execute in response to the selected events and priorities. [Table 90 on page 456](#) provides command options.
7. Click **Ok**.

Editing a notification

Note: You cannot change the name of a notification.

To edit a notification:

1. From the **Administration** window, click **Configuration**.
2. Click **Notifications**.
3. Right-click the notification to edit, then select **Properties**. The **Properties** dialog box appears.
4. Make any required changes, then click **Ok**.

Copying a notification

To copy a notification:

1. From the **Administration** window, click **Configuration**.
2. Click **Notifications**.
3. Right-click the notification to copy, then select **Copy**. The **Create Notification** dialog box appears, containing the same information as the notification that was copied, except for **Name** attribute.
4. In the **Name** attribute, enter a name for the new notification.
5. Edit any other attributes as appropriate, then click **Ok**.

Deleting a custom notification

To delete a custom notification:

1. From the **Administration** window, click **Configuration**.
2. Click **Notifications**.
3. Right-click the notification to delete, then select **Delete**.
4. When prompted, click **Yes** to confirm the deletion.

Note: You cannot delete any of the preconfigured notifications.

Indexes

The NetWorker server tracks the files it backs up in two databases, which are stored on the local file system of the server:

- ◆ The client file index tracks the files that belong to a save set. There is one client file index for each client.
- ◆ The media database tracks:
 - Volume name
 - Backup dates of the save sets on the volume
 - File systems in each save set

Unlike the client file indexes, there is only one media database per server.

The client file indexes and media database can grow to become prohibitively large over time. [“Managing the size of the online indexes” on page 459](#) provides information about managing the size of these indexes.

Characteristics of the online indexes

The size of an index is proportional to the number of entries it contains. The media database is usually smaller than the client file index, because the media database stores one entry for each volume, while the client file index stores one entry for each file saved on that volume. The NetWorker server selects which volume to mount for recovering a file by mapping the saved files to their volumes.

Each entry in the client file index includes this information for a backed-up file:

- ◆ Filename
- ◆ Number of blocks
- ◆ Access permissions
- ◆ Number of links
- ◆ Owner
- ◆ Group
- ◆ Size
- ◆ Last modified time
- ◆ Backup time

The online indexes grow with each backup, as entries are added for each newly backed-up file and save set. As long as an index entry for a file remains in the client file index, you can recover the file. Over time, the size of these indexes can grow very large.

Note: If the file system that contains the indexes gets full, the NetWorker server is unable to access the media database and is thus unable to access and recover data. Unless you configure the server to control the size of the online indexes by using browse and retention policies, they continue to grow until they exceed the capacity of the file system.

NetWorker uses browse and retention policies to manage the lifecycle of data, and to automatically control the size of the client file index. [“About browse and retention policies” on page 158](#) provides information on policies.

Automated index activities

The NetWorker server performs these online index activities:

- ◆ Inserts entries in the client file index for each file saved during a backup. For each new backup, the NetWorker server acquires more space from the file system for the new entries.
- ◆ Removes entries and returns disk space to the operating system. The browse and retention policies automatically determine when entries are removed from the index.

You can also remove index entries manually by clicking Remove Oldest Cycle in the Index Save Sets dialog box. [“Removing the oldest save set cycles” on page 460](#) provides more information.

Checking online indexes

Each time the NetWorker server starts, it uses **nsrck -ML1** to perform a level 1 consistency check on the client file indexes. In some circumstances, this consistency check will not detect corruption in the client file indexes. If you believe an index may be corrupt, run a higher level check on the index, for example:

```
nsrck -L5
```

If the index is still corrupt, recover the index by using the procedure outlined in [“Recovering online indexes for a NetWorker server” on page 337](#).

It is also good maintenance practice to periodically run the **nsrck -F** and **nsrim -X** commands to check the integrity of the client and media indexes. The *EMC NetWorker Command Reference Guide* or the UNIX man pages provide more information about these commands.

Viewing information about the indexes

To view information about the indexes:

1. From the **Administration** window, click **Media**.
2. In the left pane, click **Indexes**. The right pane displays index information for all clients of the server.

Table 90 on page 456 identifies the index information displayed for each client.

Table 90 Indexes window information

Column	Description
Client Name	Names of the NetWorker clients that have been backed up by the current server.
Size	Amount of disk space currently allocated to the client file index. As the index size increases, the allocated disk space automatically grows.

Index save sets

The Index Save Sets dialog box displays the save sets assigned to a particular client, along with detailed information about each save set. It also includes an option to remove old save set cycles.

Viewing client save set information

To view the information about client save sets:

1. From the **Administration** window, click **Media**.
2. Click **Indexes**.
3. Right-click the client whose save sets you want to view, then click **Show Save Sets**. The **Index Save Sets** dialog box appears.
4. To view detailed information about a save set, click the save set name.

Table 91 on page 456 identifies the information in the **Save Sets** dialog box for each save set.

Table 91 Index save sets dialog box information

Column	Description
Save Set Name	Name of the save set.
Size	Estimated amount of the index space used by the save set in the client file index.
Cycles	Number of backup cycles available for browsing. A cycle starts with a full backup and ends with the next full backup, and includes any incremental and level 1–9 backups that occur between full backups.
SSID	Unique identification number of the instance of the save set.
Files	Number of files backed up during that instance.
Size	Size of the backup.
Time	Date and time of the backup.
Level	Level of the backup (full, incr [incremental], or 1-9)

“Reducing client file index size” on page 459 provides information about reducing the size of the client file indexes by using the Remove Oldest Cycle button.

Querying the media database

You can query the media database for information about save sets. Queries apply to all complete, browsable save sets, not just those from the last 24 hours.

To query the media database:

1. From the **Administration** window, click **Media**.
2. Click **Save Sets**.
3. On the **Query Save Sets** tab, indicate the appropriate query parameters, then click the **Save Set List** tab to run the query and view the results.

Note: If the query is unsuccessful, an **Error** dialog box appears indicating that no save sets were found that matched the specified query. Click **OK** to close the dialog box.

You can also query the media database by using the **mminfo -av** command. The *EMC NetWorker Command Reference Guide* or the UNIX man pages provide a complete description of the **mminfo** command and its options.

Cross-checking client file indexes

By cross-checking, you can verify the consistency between the client file index and the media database. If the NetWorker server finds entries in the client file index that do not have corresponding entries in the media database, it removes the client file index entries. This feature is useful, for example, if you perform an index operation and the server crashes before the NetWorker server has completely updated the indexes. Once the server is running again, cross-check to accurately update the online indexes.

To cross-check a client file index:

1. From the **Administration** window, click **Media**.
2. Click **Indexes**.
3. Right-click the client with the index to cross check, then select **Cross Check Index**.

The NetWorker server displays this prompt:

```
Cross-checking may take considerable time. Would you like to
cross-check
client_name?
```

4. Click **Yes** to continue. The NetWorker server displays a status box until the cross-checking is complete.

Refreshing index information

Occasionally refresh the information in the Indexes tab, particularly if you are connected to a server for a long period of time.

To refresh the index information:

1. From the **Administration** window, click **Media**.
2. Click **Indexes**.
3. From the **View** menu, select **Refresh**.

Client file index locations

During the initial client setup, the NetWorker software normally designates a default location for the client file index on the NetWorker server. This default location is:

- ◆ For UNIX: /nsr/index/client_name
- ◆ For Windows: <NetWorker_install_path>\index\client_name

However, you may need to designate a different index location when first configuring a Client resource, or you might need to move the file index of an existing client. These sections address these needs.

Designating the client file index location for a new client

To designate a nondefault client file index location when creating a new client:

1. From the **Administration** window, click **Configuration**.
2. Right-click **Clients**, then select **New**. The **Create Client** dialog box appears.
3. Click the **Globals (2 of 2)** tab.
4. In the **Index Path** attribute, enter the full path of the directory where the client file index will reside.
5. For the remaining tabs, enter information as necessary to create the new client. [“Setting up a scheduled backup” on page 55](#) provides instructions.
6. Click **Ok**.

Changing the client file index location for an existing client

Note: To change the client file index location to a nondefault location for an existing client, you must first move the index to its new location. [“Moving a client file index” on page 459](#) provides more information.

To change the client file index location to a nondefault location for an existing client:

1. From the **Administration** window, click **Configuration**.
2. Click **Clients**.
3. Right-click the client with the client file index location to be changed, then select **Properties**. The **Properties** dialog box appears.
4. Click the **Globals (2 of 2)** tab.
5. In the **Index Path** attribute, enter the full path of the directory where the client file index now resides.
6. Click **Ok**.
7. (Optional) From a command prompt, run the **nsrck** or **nsrls** command and check the output for any errors.

For example, to run **nsrck** on client *jupiter*, type:

```
nsrck -L6 jupiter
```

The resulting output will be similar to:

```
nsrck: checking index for 'jupiter'
nsrck: C:\nsr\indexes\jupiter contains 54 records occupying 7 KB
nsrck: Completed checking 1 client(s)
```

Note: Depending on the size of the client file index, running either **nsrck** or **nsrls** can take a considerable amount of time. Running the **nsrck -L6** command, as shown in the example, also checks the index for corruption.

If no problems are found, then all future client file index information is saved to the new location.

Moving a client file index

You can move a client file index from its current location to a new location. For example, if the size of the client file index is too large, you can move it to a location with more space.

To move an existing client file index:

1. Ensure that no backup is currently running on the NetWorker server.
2. Copy the client file index from its current location to the new location. For example:
 - For Windows, copy `<NetWorker_install_dir>\index\jupiter` to `<new_location>\indexes\jupiter`.
 - For UNIX, type this line at a command prompt:

```
cp -rp /nsr/index/jupiter /new_location/indexes
```
3. Update the **Index Path** attribute of the **Client** resource to point to the new location of the index. [“Changing the client file index location for an existing client” on page 458](#) provides instructions.

Managing the size of the online indexes

Over time, the size of the online indexes on the NetWorker server can become prohibitively large. Reduce the size of these indexes by using the solutions suggested in these sections.

Reducing client file index size

You can reduce the size of the client file indexes on the NetWorker server by using one or more of these methods:

- ◆ Remove save sets that comprise the oldest backup cycle from the client file index. [“Removing the oldest save set cycles” on page 460](#) provides details.
- ◆ Delete volume-based entries from the client file index. [“Deleting volume-based online index entries” on page 461](#) provides details.
- ◆ Adjust the Browse Policy and Retention Policy attributes of clients backing up to the NetWorker server to shorten the period of time that entries remain in the client file indexes. This solution works only for client backups that occur after you change these policy attributes.
- ◆ Modify the browse policy associated with a particular save set by using the **nsrmm -w** command. Unless the associated save set contains a large number of files, this method may not be a practical method to reduce the index size. [“Modifying the browse and retention policy on a save set” on page 168](#) provides details.

If the size of the client file index for a client is still too large, consider moving the location of the index. [“Moving a client file index” on page 459](#) provides details.

Reducing media database size

Reduce the size of media database on the NetWorker server by using one or more of these methods:

- ◆ Remove volumes that contain recyclable save sets from the NetWorker inventory. [“Removing volume-based entries from the online indexes” on page 461](#) provides details.

When a volume is removed from the media database, the entries associated with that volume are removed from the media database and the online file index on the client. If you select this option, you will still be able to recover the data on the volume by using the **scanner** program.

Note: Very little disk space is gained by removing a media database entry. Leaving index entries of a volume in the media database prevents the accidental labeling of another volume with the same name.

- ◆ Recycle volumes that contain recyclable save sets. [“Changing a volume’s mode” on page 291](#) provides details.

When a volume is recycled, the NetWorker server performs these procedures:

- Relabeling
- Deletion from the media database
- Reinitialization

Once a volume is recycled, its content cannot be recovered.

To increase the number of currently recyclable save sets, modify the retention policy associated with the current media database by using the **nsrmm -e** command. [“Modifying the browse and retention policy on a save set” on page 168](#) provides details.

- ◆ Compress the media database. [“Compressing the media database” on page 462](#) provides details.

Removing the oldest save set cycles

Client file index entries for a full save set cycle include the last full backup and any dependent incremental or level saves. Removing the oldest cycle frees up disk space.

To remove the oldest save set cycles:

1. From the **Administration** window, click **Media**.
2. Click **Indexes**.
3. Right-click the appropriate client, then select **Show Save Sets**.
4. Select the save set with the oldest cycle to remove, then click **Remove Oldest Cycle**.
5. When prompted, click **Yes** to confirm the removal.

After the Remove Oldest Cycle operation has finished, the statistics in the Index Save Sets dialog box are updated to reflect the current state of the client file index.

Removing volume-based entries from the online indexes

The main purpose of removing volume-based entries from the online indexes is to eliminate damaged or unusable volumes from the NetWorker server. You can also use this feature to reduce the size of the online indexes by purging index entries associated with specific volumes.

Removing client file index entries

You can remove just the entries contained in the client file index by using the **nsrmm** command. This changes the status of the browsable save sets to recoverable. At the command prompt, enter:

```
nsrmm -d -P -S ssid
where ssid is the save set ID for the save set.
```

Use **mminfo** to determine the save set ID. At the command prompt, type:

```
mminfo -v -c client_name
```

The *EMC NetWorker Command Reference Guide* or the UNIX man pages provide information on the **nsrmm** and **mminfo** entries.

When save sets are marked recoverable, users may no longer browse and recover these files by using the **NetWorker User** program on Windows or the **nwrecover** program on UNIX. The save set recover procedure must be used to recover data once the client file index entries are removed. [“Recovering by save set selection” on page 325](#) provides details.

Removing client file index and media database entries

You can remove both the client file index and media database entries. This action removes all traces of the volume from the NetWorker server. Remove a volume from the media database only if the volume has been physically damaged and is unusable. However, if you remove the database entries for a volume, and the volume is undamaged, the data remains recoverable by using the **scanner** program. [“Recovering online indexes for a NetWorker server” on page 337](#) provides details.

Typically, do not remove both the client file index and media database entries at the same time *unless* the volume is damaged or destroyed.

Note: The presence of a clone of the particular volume prevents the deletion of the volume entry in the media database. This is because the NetWorker server accesses the cloned volume rather than the original volume as needed. The entry of the volume in the media database is never actually purged. Because of this functionality, removing volume entries from the media database is not a particularly effective way to reduce index size.

Deleting volume-based online index entries

To delete volume-based entries from the online indexes:

1. From the **Administration** window, click **Media**.
2. Click **Volumes**.
3. Right-click the volume with the entry to delete from the online indexes, then select **Delete**.

4. Select one of these options to determine how volume entries will be removed:
 - **File and Media Index Entries.** [“Removing client file index entries” on page 461](#) provides details about this option.
 - **File Index Entries Only.** [“Removing client file index and media database entries” on page 461](#) provides details about this option.
5. Click **Ok**.

The NetWorker server first cross-checks the indexes before it purges a volume. As a result, the volume might still appear in the Volumes window for a brief period of time.

Deleting volume based index entries from the command line

You can also remove online index entries with the `nsrmm` program. To remove both client file index and media database entries for a particular save set, enter this line at the command prompt:

```
nsrmm -d -S ssid
```

To remove all information related to a particular volume, enter this line at the command prompt:

```
nsrmm -d volume_name
```

Deleting deduplication save sets

[“Deleting Avamar deduplication save sets” on page 679](#) provides information on deleting deduplication save sets.

Compressing the media database

You can free up more space on the server by compressing the media database.

To compress the media database:

1. Delete the appropriate file:
 - On Windows:

```
<NetWorker_install_dir>\mm\.cmprssd
```
 - On UNIX:

```
/nsr/mm/.cmprssd
```
2. Type at the command prompt:

```
nsrim
```

Querying deduplication save sets using mminfo

[“Querying Avamar deduplication save sets using mminfo” on page 679](#) provides information on querying deduplication save sets.

Updating NetWorker clients by using the software distribution feature

Use the software distribution feature to remotely distribute and update the NetWorker software from a centralized NetWorker server to one or more NetWorker clients.

You can update these NetWorker software packages on computers that have the NetWorker release 7.3 or later client software already installed:

- ◆ Client
- ◆ Storage node
- ◆ Man pages
- ◆ NMO, NMSQL and NMExch NetWorker Application Modules

Note: The software distribution feature is not supported on HP Tru64 UNIX, IRIX, Mac OS X, NetWare, Open VMS platforms, and cluster environments.

The software distribution feature can be used to:

- ◆ Manage the software repository.
- ◆ Inventory NetWorker software installed on NetWorker clients.
- ◆ Update NetWorker software packages on existing NetWorker clients.
- ◆ Monitor software distribution inventory and upgrade operations (only available from the Software Administration Wizard).

Software distribution can be performed on the NetWorker client software using either the Software Administration Wizard or the **nsrpush** command. The *NetWorker Installation Guide* or the **nsrpush** man page provides information on how to update the NetWorker client software.

Message log management

The NetWorker server stores the messages generated by the NetWorker server daemons in a message:

- ◆ On Windows: <NetWorker_install_dir>\logs
- ◆ On UNIX: /nsr/logs

You can use environment variables and/or UNIX startup scripts to automatically control the size of the log.

Note: In addition to controlling the log file size through variable settings and startup scripts, excess logging of messages (for example, the repetition of authentication error messages) has been reduced in the daemon log file.

Setting the UNIX startup script to trim log files

To modify the way that NetWorker services manage the NetWorker log files, the `NSR_MAXLOGSIZE` environment variable can be set in the NetWorker startup script before the line:

```
(echo 'starting NetWorker daemons:') > /dev/console
```

Table 92 on page 464 lists the location of NetWorker startup scripts:

Table 92 NetWorker startup script location

Operating system	Startup script location
Solaris, Linux, and IRIX	/etc/init.d/networker
HP-UX	/sbin/init.d/networker
HP Tru64	/sbin/init.d/NSRstartstop
AIX	/etc/rc.nsr

Enter the environment variables by using the format (bourne shell example):

```
ENV_VAR_NAME=value
export ENV_VAR_NAME
```

These environment variables can be used to trim log files at startup:

- ◆ To change the maximum size of log files, change the NSR_MAXLOGSIZE value. The default value for NSR_MAXLOGSIZE is 1048576 bytes.
- ◆ To change the maximum number of log files that are saved, change the NSR_MAXLOGVERS value. The default value is 4.

For example:

```
NSR_MAXLOGVERS=3
export NSR_MAXLOGVERS
NSR_MAXLOGSIZE=524288
export NSR_MAXLOGSIZE
```

Restart the NetWorker server for the environment variables to take effect.

Every time the NetWorker server starts, it checks the size of the daemon log file. When the daemon log file reaches the size defined in NSR_MAXLOGSIZE or the default size of 2 MB, the following occur:

1. The existing daemon.raw log file is renamed daemon_<date_time>.raw and a new empty daemon.raw log file is created.
2. This process is repeated until the value in NSR_MAXLOGVERS is reached, at which point the oldest log is removed.

Note: The trimming mechanism functions only when you start **nsrd** on UNIX or the NetWorker Backup and Recover Server service on Windows. The daemon and service do *not* check periodically to determine if the log file has exceeded NSR_MAXLOGSIZE. If the **nsrd** daemon or NetWorker Backup and Recover Server service runs for a long time, the log file can still grow very large.

To activate the trimming mechanism:

- ◆ On UNIX, enter **nsr_shutdown** to stop the NetWorker daemons, and then use the NetWorker startup script to restart the daemons.
- ◆ On Windows, stop and restart the NetWorker Backup and Recover Server service.

The *EMC NetWorker Command Reference Guide* or the UNIX man pages provide information about the **nsr_shutdown** command and its options.

Savegroup job information

By default, when a group is backed up, details of the corresponding savegroup's child jobs are temporarily saved to files in the following location, `NetWorker_install_dir\nsr\tmp\sg\savegroup_name`. There is no easy way to associate the output of a savegroup's child jobs with the parent savegroup job. Additionally, these output files were overwritten when the group is next backed up.

Beginning with NetWorker 7.5, you can specify that the details of a savegroup's child jobs be saved in files that are named according to the child job ID. These files are saved to, `NetWorker_install_dir\nsr\logs\sg\savegroup_name\Job_ID` where *Job_ID* is a file whose name corresponds to a savegroup child job ID.

To help locate and retrieve information about a savegroup's child jobs, use the **jobsquery** command to search the NetWorker jobs database. The man pages or the *EMC NetWorker Command Reference Guide* provide more information.

To have savegroup child logs saved by job ID:

1. In the **Administration** window, click **Configuration**.
2. In the left pane of the **Configuration** window, select the NetWorker server.
3. From the **File** menu, select **Properties**.
4. Select the **Configuration** tab.
5. Select the **Savegroup log by job id** attribute.
6. Click **Ok**.

Note: When the Savegroup log by job id attribute is enabled, the job files saved to `NetWorker_install_dir\nsr\logs\sg\savegroup_name` will be purged based on the settings in the NetWorker server attributes named, Jobsdb retention in days and Jobsdb maximum size (KB).

Internationalization

NetWorker releases 7.4 and later have been internationalized. As a result, the NetWorker software now supports language packs, which can be installed as part of the NetWorker installation, or can be installed separately after the NetWorker software has been installed. The *NetWorker Installation Guide* provides more information.

Internationalization support in the NetWorker software is dependent on the underlying operating system's internationalization support. If you are planning on using non-English data in the NetWorker software, make sure the appropriate support for that language has been installed and configured on the operating system.

There are a number of issues and limitations related to the use of NetWorker software in a multi-language environment, which are addressed in the following sections.

Log file viewer

NetWorker log files must be viewed using the `nsr_render_log` program. "[Viewing log files](#)" on page 663 provide more information.

Interoperability with previous releases of NetWorker

Multiple locales within the same datazone are fully supported only if all NetWorker installations in the datazone are at release level 7.4. The following limitations apply:

- ◆ In datazones with a NetWorker release 7.3 server and NetWorker 7.4 clients, support for scheduled backups of path or filenames containing non-ASCII characters is limited to the support provided by NetWorker release 7.3.
- ◆ Binaries from releases earlier than 7.4 may not correctly display UNIX save sets containing non-ASCII characters.

Display issues

There are number of issues and limitations associated with displaying characters in various locales.

Character display at the command line

From the command line, characters supported by the current locale display correctly. Characters not supported by the user's current locale will display incorrectly. For Microsoft Windows systems, if the user and system locales do not match, characters supported in the user locale but not the system locale may not be displayed correctly.

Character display in graphical user interfaces

Character display from within NetWorker graphical user interfaces varies depending on the platform on which the graphical user interface is running:

- ◆ Microsoft Windows:
 - Any Unicode encoded data will be displayed correctly.
 - When viewing UNIX path and filenames, path and filenames created by using a character set supported by the current locale or UTF-8 will be displayed correctly. Paths created by using another character set may not display correctly. Because Microsoft Windows does not have native support for many character sets used on UNIX (for example, euc-jp, euc-cn and euc-tw), if a non-ASCII character is encoded by using these character sets, it will not be displayed correctly on Microsoft Windows.
- ◆ UNIX and Linux:
 - Characters not supported by current locale may not be displayed correctly.
- ◆ Mac OS X
 - Because of differences in Unicode support, non-ASCII paths and filenames on Mac OS X machines may not display correctly when browsing the filesystem from a non-Mac platform.

Maximum path and save set length

For the NetWorker software, the maximum supported length for a pathname is twelve kilobytes, and the maximum length for a save set name is 1024 bytes. The number of characters allowed by each of these limits will vary depending on the locale.

All operating systems have an internal limit for path and filenames. The limit varies depending on the operating system and file system being used. Typically, the pathname component size is 256.

For UNIX and Linux, only the path component length is checked against the limit. As a result, it is possible to create a path and filename that is greater than the limit supported by the operating system, but an attempt to access this path will result in a failure.

Group completion messages

Group completion messages displayed in the NetWorker console, displayed either through the Group details, Group status, or monitoring, will be displayed in the language used by the NetWorker server that generated the message.

Locale-specific configuration issues on UNIX/Linux

This section describes certain configuration issues related to Client and Archive Request resources for clients that run in UNIX/Linux environments.

Configuring the Save Set attribute for Client and Archive Request resources

For clients that run on non-ASCII locales on UNIX and Linux platforms, or for clients on Microsoft Windows that are being configured from UNIX hosts that use non-ASCII locales, special considerations apply when typing a path or filename in the Save Set attribute for Client or Archive Request resources. The path or filename must be entered in the locale that was used when the path or file was created. If you enter a path or filename by using a locale other than the one that was used when the path or file was created, subsequent backups will fail with the following error message:

```
No such file or directory
```

To configure a Client resource in this situation, either:

- ◆ Use the **All** keyword for the **Save Set** attribute.
- ◆ Log into a client host by using the correct locale, and configure the client from this machine.

Client resources with multiple locales on UNIX/Linux

To back up a UNIX or Linux machine that contains path or filenames with multiple locales, you must create a separate Client resource for each locale.

For example, to configure a multi-locale UNIX machine with data in both Japanese and French, you must create two different Client resources, one defining the save sets for the Japanese data, another defining the save sets for the French data.

[“Multiple clients from the same computer” on page 485](#) has information about creating multiple clients.

Locale settings with NDMP

When running NDMP backups, the locale setting has to be consistent in your environment. All UNIX flavored locale settings on the filer (including UTF-8) must be the same and the NMC client can be run only on a UNIX client set to the exact same locale setting as the filer.

Backup and recovery operations can be run on any locale, but if you try to browse on a locale that is different from the original locale the filenames appear as random characters.

This chapter covers these topics :

- ◆ NetWorker client overview 470
- ◆ Client configuration 470
- ◆ Creating a client probe..... 473
- ◆ Associating a probe with a Client resource 474
- ◆ Configuring a client for BMR support 474
- ◆ Lockbox pass phrase management 475
- ◆ NetWorker authentication..... 476
- ◆ Multiple clients from the same computer..... 485
- ◆ Scheduled backups of non-ASCII files or directories 486
- ◆ Adding or changing the NetWorker servers for a client 486
- ◆ Client priority 487
- ◆ Dedicated client/server interface for backup and recover operations 488

NetWorker client overview

A NetWorker client is both a physical computer with NetWorker client software installed on it, and a NetWorker server resource that specifies a set of files and directories to be included in a scheduled backup. As such, a single NetWorker client computer can have several Client resources specified that can back up to the same or even different NetWorker servers.

[“Defining a client and save set combination” on page 485](#) further explains concept of a client computer with multiple NetWorker Client resources.

NetWorker client software is available for a variety of platforms. No matter which platform the client resides on, it can be backed up to any NetWorker server. For example, you can back up a NetWorker client on a Microsoft Windows computer to a NetWorker server on a Solaris computer.

Client configuration

Before a client can be backed up by a NetWorker server, the client computer must have the appropriate NetWorker client software installed. The NetWorker Installation Guide provides more information.

Creating a client

NetWorker client creation is part of the process of creating a scheduled backup. [“Setting up a scheduled backup” on page 55](#) provides information on how to create a client.

Editing a client

Use this procedure to change Client resource attributes. You cannot change the name of a client with this procedure. [“Changing a client name” on page 471](#) provides information on how to change a client name.

To edit a client:

1. From the **Administration** window, click **Configuration**.
2. Click **Clients**.
3. Right-click a client, then select **Properties**. The **Properties** dialog box appears, with the **General** tab displayed.
4. Edit the attributes of the client, then click **OK**.

Copying a client

Use this procedure to copy Client resource attributes.

To copy a client:

1. From the **Administration** window, click **Configuration**.
2. Click **Clients**.

3. Right-click a client, then select **Copy**. The **Create Client** dialog box appears. By default, the new client retains the information from the client that was copied, except the Name attribute, which is blank.
4. Enter the name for the new client and edit other attributes as appropriate, then click **OK**.

Changing a client name

The only way to change the name of a client is to re-create the client.

1. From the **Administration** window, click **Configuration**.
2. Click **Clients**.
3. Right-click the client to be renamed, then select **Properties**. The **Properties** dialog box appears.
4. Click the **Globals (1 of 2)** tab.
5. Record the **Client ID** attribute listed for the client, then click **Cancel** to close the **Properties** dialog box.
6. Delete the original client from the **Administration** window. See [“Deleting a client” on page 471](#).
7. Stop all NetWorker services.
8. On the NetWorker server that backs up this client, rename the directory containing the client file index for this client from *old_client_name.domain.com* to *new_client_name.domain.com*. The default location for the client file index is:
 - For UNIX/Linux:

```
/nsr/index/client_name.domain.com
```
 - For Microsoft Windows:

```
<NetWorker_install_path>\index\client_name.domain.com
```
9. Restart the NetWorker services.
10. Create a new client, making sure that you enter the client ID that you recorded in [step 5](#) in the **Client ID** attribute of the **Globals (1 of 2)** tab of the **Create Client** dialog box. [“Setting up a scheduled backup” on page 55](#) provides instructions on how to create a client.

Deleting a client

When a client is deleted, the NetWorker server can no longer back up or recover files from the client computer. The backup history for the client remains in the client file index and media database until the entries are removed.

To delete a client:

1. From the **Administration** window, click **Configuration**.
2. Click **Clients**.
3. Right-click the client to be deleted, then select **Delete**.
4. When prompted, click **Yes** to confirm the deletion.

Note: Even if you delete a client from the NetWorker server, the previously backed-up data from the client is still accessible and recoverable directly from the volume that contains the data by using the **scanner** command.

Recovering a deleted client

To recover a deleted client, create a new client, making sure that you enter the name of the deleted client in the **Name** attribute on the **General** tab of the **Create Client** dialog box. “[Task 6: Create a backup Client resource](#)” on page 59 provides instructions on how to create a client.

The NetWorker server recalls the client ID for this name and inserts it into the **Client ID** attribute on the **Globals (1 of 2)** tab of the **Create Client** dialog box.

Editing a client NSRLA database

The NSRLA database contains a NetWorker resource, called the NSRLA resource, which has attributes that apply to the client, such as the Disable Directed Recover attribute. In some cases, it may be necessary to edit the NSRLA resource. The NSRLA resource can be edited by using the character-based **nsradmin** program.

Note: “[Enabling directed recoveries](#)” on page 331 provides information about permissions for directed recoveries and the Disable Directed Recover attribute in the NSRLA resource.

To edit the NSRLA database:

1. Log in as root or as Windows Administrator on the NetWorker client.
2. Type this at the command prompt:

```
nsradmin -p nsrexec
```

The **nsradmin** prompt appears.

3. To determine the current settings for attributes in the **NSRLA** resource, perform the following two steps:
 - a. To determine the current settings for any hidden attributes (such as the Disable Directed Recover attribute), type the following at the **nsradmin** prompt:
4. To change the value of attributes in the **NSRLA** resource, type this line at the **nsradmin** prompt:

```
option Hidden
```

- b. To display attributes, type the following:

```
print type:NSRLA
```

```
update attribute:value;
```

For example, to update the **Disable Directed Recover** attribute, type:

```
update disable directed recover:Yes
```

5. Type **Yes** when prompted to confirm the change.

Note: When modifying an attribute with the `nsradmin` program, the attribute name and value must be specified correctly. If the attribute name and value are not specified correctly, the attribute is not updated. No error message is provided.

Restricting access to view the client NSRLA database

By default, a UNIX root user on any host can view the NSRLA database on any UNIX NetWorker client. In the same way, any Windows administrator can view the NSRLA database settings on any Windows NetWorker client. You can restrict access so that only the root (UNIX) or Administrator (Windows) on the local host can view the NSRLA database.

To restrict the ability to view the NSRLA database:

1. Log in as root or as Windows Administrator on the NetWorker client.
2. Type the following at the command prompt:

```
nsradmin -p nsrexec
```

The `nsradmin` prompt appears.

3. Determine the current settings for the attributes in the NSRLA resource:

```
print type:NSRLA
```

By default the Administrator attribute will look similar to the following:

Windows

```
administrator: Administrators, "group=Administrators,host=saturn";
```

UNIX

```
administrator: root, "user=root,host=saturn";
```

4. Change the value of the Administrator attribute to remove the single *Administrators* or *root* value:

Windows

```
update administrator: "group=Administrators,host=this_host"
```

UNIX

```
update administrator: "user=root,host=this_host"
```

where *this_host* is the name of the local host.

5. Type **Yes** when prompted to confirm the change.

Now, only the Windows Administrator or root on the local host can view the NSRLA database.

Creating a client probe

Note: Users are responsible for creating and supporting user defined probes.

To create a client probe:

1. From the **NetWorker Administration** window, click **Configuration**.
2. Right-click probes, and select **New**. The **Create NSR probe** window opens.

3. Type the name of the probe in the **Name:** field.
4. (Optional) Include details for the probe script in the **Comment:** field.
5. Type the name, and path of the probe script in the **Command:** field. The probe resource script must be placed in the same directory as the nsr binaries for each client referencing the probe. For example, /usr/sbin on Solaris and Linux. The *NetWorker Installation Guide* provides details on default installation paths for all operating systems.

A user defined probe is any program which passes a return code. Return codes are interpreted by NetWorker as follows:

- Return code 0: backup is required
- Return code 1: backup is not required
- All other return codes are interpreted as errors during probe execution, and backups are not taken

Note: The probe script name must begin with save, or nsr.

6. Associate the probe with a Client resource as described in [“Associating a probe with a Client resource” on page 474](#).

Note: The **Command Options:** field is applicable to NetWorker Module probes only.

Associating a probe with a Client resource

To associate a probe resource with a Client resource:

1. Click **Clients**, and right-click the client in the **Configuration** screen of the **NetWorker Administration** window.
2. Select **Properties**, and the **Properties** window opens.
3. In the **Apps & Modules** tab, select the probe from the **Probe resource name:** list. All defined probe resources appear in the list. If the list is empty, then probe resources were not defined. [“Creating a client probe” on page 473](#) provides details on creating a probe resource.

Note: Each client in a group can have a probe associated with it, but a probe is not required. However, a probe-based backup group must have at least one probe-enabled client associated with it. If a single probe is referenced by multiple clients, make sure that the probe resource script is in the same directory as the NetWorker binaries for each of the clients referencing the probe.

Configuring a client for BMR support

The HomeBase Agent is automatically installed with the NetWorker client. After enabling communication with a HomeBase Server, configure a NetWorker client or start by editing an existing client. [“Configuring a client for BMR support” on page 657](#) provides detailed instructions.

Note: A HomeBase Agent license batch code is required to enable the client to generate profiles and send them to the HomeBase Server. Contact your EMC HomeBase representative for licensing information.

Lockbox pass phrase management

The NetWorker server provides NetWorker modules, and certain NetWorker features, such as AES encryption, with the ability to securely store and retrieve passwords over a network.

To use the lockbox pass phrase management feature for a NetWorker module:

1. Log in as root, or as Windows administrator on the NetWorker server.
2. In the client **NetWorker Administration** window, click the **Configuration** tab.
3. Right-click **Lockboxes**, and select **New**. The **Create NSR Lockbox** window opens.
4. Type a name in the **Name:** field.
5. Type the users that will have permission to store, retrieve, and delete passwords in the **Users:** field. Use the *user@destination_client* or *user@hostname* format when listing users.
6. Verify that the lockbox is listed in the **NetWorker Administration** window.

Set the Datazone pass phrase for a NetWorker server

[“Set the Datazone pass phrase for a NetWorker server” on page 77](#) provides information on how to set the Datazone pass phrase on a NetWorker server.

Set the Remote access attribute for NetWorker client resource when lockbox is created for a NetWorker server on a cluster

If a lockbox is created for a NetWorker server configured on a cluster, the following step must be performed in order for the lockbox to work on the cluster node the NetWorker server is running on:

- ◆ The **Host** section for the NetWorker client resource's **remote access attribute** must list the names of all the cluster nodes. The values of the names must be in the following form:
 - For UNIX cluster nodes, use the hostname command output
 - For Windows cluster nodes, use the full computer name (go to **Control Panel > System > Computer name** to get the full name)

Note: The lockbox can be created prior to or after performing this step.

This configuration must be performed during the initial startup of the virtual NetWorker server (that is, before the virtual server fails over to the other cluster). Otherwise, the lockbox will have to be deleted and then re-created.

Error messages and error handling for the Datazone pass phrase

The following messages are written to the daemon.log file if an error occurs during the encryption, or decryption of the Datazone pass phrase:

- ◆ Encryption error:

```
Error encrypting key. Erasing datazone pass phrase.
```

The Datazone pass phrase is saved as a blank phrase.
- ◆ Decryption error:

```
Error decrypting key. Erasing datazone pass phrase for current use.
```

A blank pass phrase is used in place, allowing any backup requiring a key to continue by using the default key.

NetWorker authentication

This section describes how to configure authentication between NetWorker hosts. This section also includes special considerations for authentication.

Two types of authentication are supported for NetWorker hosts:

- ◆ nsrauth
- ◆ oldauth

Strong authentication (nsrauth)

The **nsrauth** authentication mechanism (enabled by default) is strong authentication that is based on the Secure Sockets Layer (SSL) protocol, which is provided by the OpenSSL library. NetWorker hosts and NetWorker user permissions are authenticated by using **nsrauth**. The **nsrauth** authentication mechanism is available for hosts that run NetWorker software release 7.3 or later.

Each NetWorker host has a **nsrexecd** service, which provides authentication services. Each **nsrexecd** has its own private key and self-signed certificate for authentication. The private key is generated by **nsrexecd** when it starts up or one can be loaded from a file. The corresponding self-signed certificate is generated by the private key. The private key is RSA and is 1024 bits in length. The encryption method that is used once an SSL session is set up is AES-128. The session information sent over the SSL connection includes:

- ◆ Session keys
- ◆ Session ID
- ◆ User's information
- ◆ User's NetWorker permissions

This product should only be used where network-layer authentication prevents rogue hosts from connecting or accessing network traffic.

Authentication for backwards compatibility (oldauth)

For compatibility with earlier NetWorker releases, **oldauth** authentication is supported. If two hosts cannot authenticate by using strong authentication (**nsrauth**), you can enable authentication by using **oldauth**. One can specify the minimum authentication strength that is allowed for any host relationship. [“Specifying the minimum authentication strength between hosts” on page 477](#) provides more information.

Access privileges for authentication configuration

This section describes how to set up access privileges to maintain **nsrauth** strong authentication configuration settings.

The Console server must have permission to update resources on each NetWorker host whose authentication information will be updated:

To grant authentication update privileges to the Console server:

1. Log in as root or as Windows administrator on the NetWorker host whose authentication information will be updated.

2. Type the following at the command prompt:

```
nsradmin -p nsrexec
```

The **nsradmin** prompt appears.

3. For each of the following resources:

- NSRLA
- NSR Peer information
- NSR system port ranges

Complete the following steps:

- a. Determine the current settings for the attributes in the resource:

```
print type:resource_name
```

- b. Change the value of the Administrator attribute in the resource:

```
update administrator:current_values, "user=Console_user, host=Console_host"
```

where:

- *current_values* are the values that are currently listed for the resource's Administrator attribute.
- *Console_user* is the user ID of the Console user.
- *Console_host* is the name of the Console host.

- c. Type **Yes** when prompted to confirm each change.

Specifying the minimum authentication strength between hosts

You can specify that only certain authentication methods be allowed between specific hosts. For example, one could specify:

- ◆ That a NetWorker release 7.3 or later server be allowed to authenticate with legacy NetWorker clients by using **oldauth**.
- ◆ That all other NetWorker release 7.3 or later clients must use only **nsrauth** Strong authentication (enabled by default).

The Console server user must have permission to update authentication resources. [“Access privileges for authentication configuration” on page 476](#) provides more information.

To specify the authentication strength between NetWorker hosts:

1. From the **Administration** window, click **Configuration**.
2. Open the **Local Hosts** folder.
3. From the **Local Hosts** list, right-click the host with the authentication relationships to be configured and select **Configure Local Agent**.
4. Select the **Advanced** tab.

5. In the **Auth Methods** attribute, at the top of the list enter the minimum allowable authentication strength for the NetWorker hosts that will connect to this host. Type values in this format:

clientgroup_or_host, auth_strength

where:

- *clientgroup_or_host* is either an IP address that represents a group of hosts or an explicit hostname. For example:
 - *pluto.company.com* - An explicit NetWorker client name.
 - *10.102.0.0/255.255.0.0* - A subnet IP address representing all NetWorker clients on the subnet. Alternatively, you could type this value as *10.102.0.0/16*.
 - *0.0.0.0/0* - This value represents all clients in the domain,
- *auth_strength* is the authentication strength. The allowable values are:
 - **nsrauth** - Use strong authentication only.
 - **oldauth** - Use oldauth authentication only.
 - **nsrauth/oldauth** - Attempt to use strong authentication. If strong authentication fails, use **oldauth** authentication.

For example, if all hosts must use only strong authentication, enter:

0.0.0.0/nsrauth

IMPORTANT

The order in which values appear in the **Auth Methods** list is important. The first client match found starting from the top of the list is the authentication value used. For example, to specify strong authentication for all clients except for one, ensure that the explicit entry for the single client appears at the top of the list before the more general entry that represents all clients in the domain. If no matches are made, authentication defaults to **0.0.0.0/nsrauth**, which means that all clients can only authenticate by using **nsrauth**. [“Enforcing strong authentication on selected hosts” on page 478](#) provides details.

6. Click **OK**.
7. Restart the NetWorker services for the host with the authentication relationships to be configured. [“Stopping and starting a NetWorker server, client, or storage node” on page 51](#) provides information about restarting NetWorker services.

Example 38 Enforcing strong authentication on selected hosts

In this example, a NetWorker release 7.3 server has both release 7.3 clients and legacy clients. The requirement is to ensure that the release 7.3 clients authenticate by using only **nsrauth** strong authentication, while the legacy clients authenticate by using **oldauth** authentication.

1. From the **Administration** window, click **Configuration**.
2. Open the **Local Hosts** folder.
3. From the **Local Hosts** list, right-click the NetWorker server and select **Configure Local Agent**.
4. Select the **Advanced** tab.

- In the **Auth Methods** attribute, type the two legacy hostnames, for example:

jupiter.company.com, nsrauth/oldauth

pluto.company.com, nsrauth/oldauth

In this example, two legacy hosts identified as *jupiter.company.com* and *pluto.company.com* are allowed to use **oldauth** authentication to ensure backwards compatibility. All other hosts use only strong authentication (**nsrauth**).

- To specify that all other hosts must use strong authentication, type this value at the bottom of the list in the **Auth Methods** attribute:

0.0.0.0/0, nsrauth

The entries in the list should now be ordered as follows:

```
pluto.company.com, nsrauth/oldauth
```

```
jupiter.company.com, nsrauth/oldauth
```

```
0.0.0.0/0, nsrauth
```

The more explicit entries, those that identify a single client, are at the top of the list. The first matching entry, starting from the top of the list, is the entry used to specify a host's authentication strength.

- Click **OK**.
- Restart the NetWorker services for the NetWorker server. [“Stopping and starting a NetWorker server, client, or storage node” on page 51](#) provides information about restarting NetWorker services.

Maintaining NetWorker local host authentication credentials

Each NetWorker host that uses **nsrauth** strong authentication has unique credentials that are used to identify itself to other NetWorker hosts during the **nsrauth** strong authentication process. These credentials are known as local host authentication credentials.

Additionally, each NetWorker host maintains a copy of the local host credentials that belong to every NetWorker host to which it has authenticated. These credentials are maintained as part of the local host's Peer resources.

You can export, import, or create new credentials for a local host. You can also delete and import host credentials in Peer resources. In most cases, you do not need to perform any of these maintenance tasks. However, there are some cases in which you may need to perform these tasks. These examples provide some scenarios in which these maintenance tasks might be performed.

Note: To complete the procedures in this section, the Console server user must have permission to update authentication resources. [“Access privileges for authentication configuration” on page 476](#) provides details.

Example 39 Securing the initial peer host authentication process

When two NetWorker hosts authenticate with each other, no user intervention is required. Each host keeps a copy of the other host's authentication credentials in a Peer resource. The copy is created the first time the hosts authenticate with each other. Subsequent authentication attempts are verified by matching the host with the authentication credentials stored in the Peer resource.

To eliminate the possibility that an attacker could compromise this process, manually update the Peer resource with authentication credentials rather than have this occur automatically.

For example, suppose that the NetWorker server *jupiter* will authenticate with the NetWorker client *pluto*.

To manually update the **Peer** resources:

1. Export authentication credentials.
 - a. Export authentication credentials for *jupiter* to a file.
 - b. Export authentication credentials for *pluto* to a file.

[“Exporting local host credentials” on page 481](#) provides information about exporting authentication credentials.
2. Create a **Peer** resource for pluto on jupiter:
 - a. Open the credentials file for pluto. Refer to this file in these steps.
 - b. From the **View** menu in the **Administration** window, select **Diagnostic Mode**.
 - c. Open the **Local Hosts** folder.
 - d. From the **Local Hosts** list, click jupiter.
 - e. Right-click and select **New**.
 - f. In the **Name** attribute, enter the Name value from the credential file.
 - g. In the **Instance ID** attribute, enter the **NW Instance ID** value from the credential file.
 - h. In the **Peer Hostname** attribute, enter the **My Hostname** value from the credential file. For example:

```
certificate:\
"-----BEGIN CERTIFICATE-----
-----END CERTIFICATE-----";
my hostname: pluto.company.com;
name: pluto.company.com;
NW instance ID:
d9b61002-0004-fe5c3a37-42d5a842-00010000-8945657f;
private key:\
"-----BEGIN RSA PRIVATE KEY-----
-----END RSA PRIVATE KEY-----";
```
 - i. Click **OK**. A **Peer** resource for pluto is created.
3. Create a local host certificate file for pluto. [“Creating a local host Peer resource certificate” on page 483](#) provides details.
4. Load the certificate for pluto into the **Peer** resource:
 - a. Right-click the **Peer** resource for pluto and select **Properties**.
 - b. From the **Change Certificate** attribute list, select **Load** certificate from file.
 - c. In the **Certificate file to load** attribute, enter the path and name of the certificate file and the click **OK**.
5. Repeat steps 2 through 4 to create a **Peer** resource for jupiter on pluto.

Example 40 Local host credentials are exported

In most cases, local host credentials are retained. For example, when the NetWorker software is uninstalled and reinstalled. However, in some cases, such as with unexpected data loss, new local host credentials may need to be re-created.

Creating new local host credentials can be time-consuming, because Peer resources on all NetWorker hosts that authenticate with the local host must be updated with the new local host credentials. To avoid these updates and to save time, export the local host credentials to a file for safekeeping. Store this file in a protected location, such as on a USB stick in a safe and not on a machine attached to the network. If necessary, re-import local host credentials.

In this example, the user can either create new local host authentication credentials or save the existing credentials to a file and re-import the credentials at a later time. To save time and simplify the procedure, the user chooses to export the local host credentials to a file so that the credentials can be re-imported, if necessary.

To complete this scenario:

1. Export the local host credentials to a file. [“Exporting local host credentials” on page 481](#) provides details.
2. An event occurs in which the local host credentials are lost.
3. Re-import the host credentials to the local host mentioned in [step 1](#). [“Importing local host credentials” on page 482](#) provides details.

There is no need to update Peer resources because the local host authentication information was recovered from the file that was exported in [step 1](#).

Example 41 Local host credentials are not exported

This scenario is similar to [“Local host credentials are exported” on page 481](#), except that the local host credentials were not exported before an event such as the corruption of local host credential data. In this scenario, you must create new local host credentials and then delete all existing Peer resources for the local host.

To complete this scenario:

1. Create new local host credentials for the NetWorker host. [“Creating new local host certificate keys” on page 482](#) provides details.
2. Delete all peer certificates that are set up for the NetWorker host whose credentials were created in [step 1](#). [“Deleting NetWorker local host Peer resources” on page 483](#) provides details.

Exporting local host credentials

To export local host credentials:

1. From the **Administration** window, click **Configuration**.
2. Open the **Local Hosts** folder.
3. From the **Local Hosts** list, right-click the NetWorker server and select **Configure Local Agent**.
4. Select the **Advanced** tab.
5. From the **NW Instance Info Operations** attribute list, select **Export**.
6. In the **NW Instance Info File** attribute, enter a directory and name.
7. Click **OK**. A credential file is saved to the location specified.

Importing local host credentials

Note: On UNIX platforms, the credential file that is imported in this procedure must be set to read and write permission for root only. For example:

```
chmod 600 certificate_name
```

To import local host credentials:

1. From the **Administration** window, click **Configuration**.
2. Open the **Local Hosts** folder.
3. From the **Local Hosts** list, right-click the NetWorker server and select **Configure Local Agent**.
4. Select the **Advanced** tab.
5. From the **NW Instance Info Operations** attribute list, select **Import**.
6. In the **NW Instance Info File** attribute, enter the directory and name for the credential file to be imported.
7. Click **OK**.

The credential file will be imported from the location specified.

Creating new local host certificate keys

To create new local host certificate keys:

1. From the **Administration** window, click **Configuration**.
2. Open the **Local Hosts** folder.
3. From the **Local Hosts** list, right-click the NetWorker host and select **Configure Local Agent**.
4. Select the **Advanced** tab.
5. From the **NW Instance Info Operations** attribute list, select **New Keys**.
6. Click **OK**. A new certificate will be created for the NetWorker host.
7. On all other local host resources, delete the Peer resource that was set up for the NetWorker host whose certificate was changed in this procedure. [“Deleting NetWorker local host Peer resources” on page 483](#) provides details.

Note: Consider exporting the new certificate information to a credentials file. [“Local host credentials are exported” on page 481](#) provides information about the benefits of doing so.

Maintaining local host Peer resources

Each NetWorker host has unique authentication credentials that are used during the **nsrauth** strong authentication process. These credentials include certificate information.

Each NetWorker host retains a record of the certificate of all NetWorker hosts to which it has successfully authenticated. These records are maintained as part of each NetWorker host's Peer resource database.

Deleting NetWorker local host Peer resources

When the credentials for a NetWorker host change, so does its certificate. All hosts that have previously authenticated with the changed NetWorker host must be configured to accept the changed certificate.

Otherwise, authentication will fail because the changed certificate is no longer recognized.

For example, host A authenticates with host B. Host B will have a Peer resource for host A, which contains certificate information. Now the credentials for host A change. Host B will no longer recognize host A and authentication will fail. To solve this problem, delete host B's Peer resource for host A. The next time host A attempts to authenticate with host B, a new Peer resource will be created on host B and authentication will succeed.

To delete a local host Peer resource:

1. From the **Administration** window, click **Configuration**.
2. Open the **Local Hosts** folder.
3. From the **Local Hosts** list, click the NetWorker host whose Peer resource must be deleted.
4. Right-click the Peer resource that corresponds to the NetWorker host whose credentials were changed, then select **Delete**.

Creating a local host Peer resource certificate

To update certificate information for a local host Peer resource, delete the existing Peer resource or update the Peer resource with a certificate from a file. Before you load the certificate from a file, create the certificate as described in this section.

To create a Peer local host certificate:

1. Export the local host credentials file for the NetWorker host whose credentials have changed, if this has not already been done. [“Exporting local host credentials” on page 481](#) provides details.
2. With a text editor that is compatible with UNIX text files, open the credential file and copy and save the certificate information to a new file. Ensure that the new file is saved in a UNIX text-file format.

In this sample credential file, copy the information between the *begin certificate* and *end certificate* comments:

```
certificate:\
"-----BEGIN CERTIFICATE-----
MIIB9...
-----END CERTIFICATE-----";
my hostname: pluto.company.com;
name: pluto.company.com;
NW instance ID: d9b61002-0004-fe5c3a37-42d5a842-00010000-8945657f;
private key:\
"-----BEGIN RSA PRIVATE KEY-----
MIICW...
-----END RSA PRIVATE KEY-----";
type: NW instance Information;
```

resource identifier: 1.0.21.1.139.45.65.23.121.56.111.101(1)

This file can now be loaded into all of the Peer resources that exist for the NetWorker host whose credentials have changed. [“Securing the initial peer host authentication process” on page 479](#) provides details.

Creating a custom certificate and private key for a host

NetWorker automatically creates certificate and private keys for each NetWorker host. However, it is possible to create certificate and private key information for a host manually. One may want to do this in special cases such as when a company mandated policy stipulates that certificate and private key information must be generated on a single host that has a trusted random number generation utility. The certificate and key information can then be transferred from the trusted host to other hosts within the enterprise.

To create custom certificate and private key information for a host:

1. On the host that is being used to create the custom certificate and private file, type this command:

```
nwinstcreate -ix
```

Complete the remaining screen prompts as appropriate. The *EMC NetWorker Command Reference Guide* or the UNIX man page provide more information about **nwinstcreate**.

2. On the host for which the custom certificate and private key file was created, place the file in the following directory:

```
NetWorker_install_path\nsr\res
```

- a. On Windows hosts, you must give read, write, and modify privileges for the custom certificate and private key file to the Windows Local System Account (SYSTEM).

On Windows, NetWorker services such as **nsrexecd**, are run with SYSTEM privileges. By default, NetWorker services do not have adequate privileges to read and write the custom certificate and private key file.

- b. Ensure that the NetWorker client service, **nsrexecd**, is started on the host. [“Stopping and starting a NetWorker server, client, or storage node” on page 51](#) provides information about verifying and starting NetWorker services.

- c. Start the **nsradmin** program:

```
nsradmin -p nsrexec
```

The **nsradmin** prompt appears.

- d. Type this command:

```
. type: nsrla
```

- e. Import the custom certificate and private key file:

```
update nw instance info operations: import;
```

```
nw instance info file: NetWorker_install_path\nsr\  
res\certificate_file
```

- f. Enter **Yes** when prompted to confirm the update.

The custom certificate and private key information will be used for the host.

Multiple clients from the same computer

The NetWorker server identifies each of its clients by the client computer name.

To provide optimal flexibility, the server lets you define multiple Client resources for the same computer, with the same computer name, provided that one of these is true:

- ◆ Each client save set is unique.
- ◆ Clients are included in different backup groups.
- ◆ Clients are associated with different schedules.
- ◆ Clients are associated with different browse and/or retention policies.

For example, looking at a list of configured NetWorker clients, you might see several instances of a client named *mars*. But each instance would contain a unique collection of save sets or would be configured differently regarding groups, schedules, or policies.

Defining multiple clients from the same computer or file system can be useful for backing up specialized files, such as databases. You can use the Comment attribute in the Client resource to help distinguish between multiple Client resources with the same name.

Redefining a file system into multiple client and save set instances

If a client has a large volume of data, you can schedule the client computer for several, separate client and save set backups. By redefining a large file system into multiple client and save set instances, you are able to:

- ◆ Automatically back up a large client file system.
- ◆ Balance the load by avoiding a full backup of the entire file system at one time.

You can then associate each client and save set instance with a different backup group and/or a different schedule. Associating different client instances with different backup groups varies the start time of the backups. Staggering the start times in this way may achieve the load balancing needed.

If different backup start times do not reduce the load adequately, you can associate the different client and save set instances with different backup schedules. Recall that a client's schedule determines the level of backup (if any) that is run on a particular day. By using different schedules, you can specify that each client and save set instance run its full backup on a different day of the week. [“Schedules” on page 140](#) provide more information on schedules.

Defining a client and save set combination

The same save set can appear in the Save Set attribute of the Client resource for multiple client instances. This characteristic permits you to associate the same save set with more than one group or schedule for backup.

The save sets associated with a specific client instance are visible as a scrollable list in the Save Set attribute of the Create Client and Properties dialog boxes.

If the default value All appears in the Save Set attribute, all local data for the client computer is backed up according to the group and schedule in the Create Client and Properties dialog boxes.

To define a client and save set combination:

1. Create a new or edit an existing NetWorker client.
2. Click the **General** tab of the **Properties** dialog box for the client.
3. In the **Save Set** attribute, delete the default value **All**.
4. Complete one of these steps as appropriate:
 - To configure the client so that a specific file system is backed up, enter the file system pathname in the **Save Set** attribute.
 - To define multiple save sets on a client, enter each save set (partition, file system, or file) on a separate line in the **Save Set** attribute.

Scheduled backups of non-ASCII files or directories

When the Saveset attribute for a Client resource contains non-ASCII characters, the Save Operation attribute must set as follows:

- ◆ UNIX/Linux:
 - For NetWorker clients at release 7.4 or later, the value of the Save Operation attribute should be set to:
I18N:mode=nativepath
 - For clients at a release level prior to release 7.4, the value of the Save Operation attribute should be set to:
I18N:mode=utf8path
- ◆ For all Microsoft Windows clients, the Save Operation attribute should be set to:
I18N:mode=utf8path

If the Client Backup Configuration Wizard is used, it is not necessary to change the Save Operation attribute in the Client resource created by the wizard.

Adding or changing the NetWorker servers for a client

NetWorker uses the contents of the `/nsr/res/servers` (UNIX), or the `NetWorker_install_path\res\servers` (Windows) file on each NetWorker client to control who has client-tasking rights (the right to request a program to be executed on another client). This client-tasking might be any of the following:

- ◆ Server that performs an archive request
- ◆ Scheduled backup
- ◆ Another client that requests a directed recover

During a NetWorker software installation, you can add the names of NetWorker servers to this file. To add additional hosts at a later date, a text editor must be used to add the hostname to the file.

- ◆ So that the client with the tasking rights can back up to other NetWorker servers, the names of the additional NetWorker servers must be added to this file.
- ◆ So that other clients can perform directed recovers to the client with the tasking rights, their names must be added to the servers file.

IMPORTANT

If the servers file is empty, then any NetWorker host has tasking rights. This is a potential security concern.

Editing the servers file

To give clients client-tasking rights to a NetWorker client:

1. Stop the NetWorker host whose tasking rights are being updated. [“Stopping and starting a NetWorker server, client, or storage node” on page 51](#) provides more information.
2. Open the servers file in a text editor.
The default installation location for this file is:
 - /nsr/res/servers (UNIX)
 - *NetWorker_install_path*\res\servers (Windows)
3. Enter one hostname per line.
4. Save the changes and exit the text editor.
5. Restart the NetWorker host.

Client priority

The Priority attribute in the Client resource specifies the order in which clients are contacted for backup. The attribute can contain a value between 1 and 1,000. The lower the value, the higher the priority.

The client with the lowest value for the Priority attribute is placed at the top of the list to be contacted by the NetWorker server. If a value is not specified in the Priority attribute, the backup order is random.

While the Priority attribute specifies the order of client contact, many variables affect the order in which clients complete their backups, including these scenarios:

- ◆ The backup operation on a client does not begin until the worklists for each of the save sets on the client are complete.
- ◆ The amount of work can vary greatly from one client to the next.
- ◆ If a client stops responding and times out, the client is put at the end of the backup list.

To increase the number of times each client in a group is retried before the backup attempt is considered unsuccessful, change the value in the Client Retries attribute in the **Group** resource. [“Task 2: Set up a group for backup clients” on page 57](#) provides more information.

Note: The only way to guarantee that ClientA backs up before ClientB is to assign ClientA to a scheduled backup group that starts earlier than the group containing ClientB.

Dedicated client/server interface for backup and recover operations

If a NetWorker client must access a unique network interface on the server that is used for backup and recover operations, enter the value in the NetWorker client resource's Server network interface attribute. The value you enter should correspond to the unique hostname of the network interface on the server.

The Server network interface attribute is located in the Globals (1 of 2) tab in the client resource. This attribute does not specify the NetWorker server hostname that is used for other NetWorker processes, such as monitoring or authentication operations. All other processes use the hostname of the NetWorker server.

The server network interface attribute is used only for the NetWorker Server. The hostname of the LAN interface which is dedicated for backup on the NetWorker server must be entered here. In order to set a dedicated LAN interface for backup on storage node, use the hostname of the LAN interface which is dedicated for backup as storage node attribute and enter the hostname of the LAN interface which is dedicated for backup on NetWorker server.

For example,

To backup a client via NetWorker Server:

Storage Node Attribute : **nrsrserverhost**

Server Network Interface Attribute : A hostname of the LAN interface dedicated for backup on the NetWorker Server.

To backup a client via the storage node:

Storage Node Attribute : A hostname of the LAN interface dedicated for backup on storage node.

Server Network Interface Attribute : A hostname of the LAN interface dedicated for backup on NetWorker server.

This chapter covers these topics:

◆ Cluster terminology	490
◆ Cluster-aware and cluster-unaware NetWorker servers	491
◆ Cluster licensing	492
◆ Backing up data on Windows cluster environments	492
◆ Backing up data on UNIX cluster environments.....	494
◆ Configuring a virtual client to back up to a local storage node	497
◆ Configuring a virtual client to be recovered from a local storage node.....	498
◆ Configuring an external client to a virtual server	502
◆ Support for multiple IP addresses for one resource group	500
◆ Recovering data in a Windows cluster environment.....	502
◆ Recovering data in a UNIX cluster environment	502
◆ Tracking scheduled saves.....	503
◆ Using a physical storage node and virtual server on UNIX platforms.....	506
◆ Using autochangers and stand-alone tape devices	507
◆ Client Backup Configuration Wizard support requirements	515
◆ NetWorker cluster performance issues	516
◆ Setting NetWorker environment variables in a Sun cluster.....	517
◆ Changing the default timeout of 10 minutes for the NetWorker server in a Microsoft Cluster Server or Microsoft Failover Cluster	518

Cluster terminology

This section defines terms specific to NetWorker cluster support that are used in this document:

- ◆ Node — A physical computer that is a member of a cluster.
- ◆ Private disk — A local disk on a cluster node. A private disk is not available to other nodes within the cluster.
- ◆ Shared disk — A disk that is shared by the cluster nodes.
- ◆ Failover — A means of ensuring application availability by relocating resources in the event of a hardware or software failure. Two-node failover capability allows operations to switch from one cluster node to the other. Failover capability can also be used as a resource management tool.
- ◆ Highly available application — An application installed in a cluster environment and configured for failover capability.
- ◆ Cluster-aware NetWorker server — A NetWorker server that can recognize cluster clients.
- ◆ Cluster client — A NetWorker client within a cluster. This can be either a virtual client, or a NetWorker Client resource that backs up the private data that belongs to a one of the physical nodes.
- ◆ Virtual client — A NetWorker Client resource that backs up data that belongs to a highly available service or application within a cluster. Virtual clients can fail over from one cluster node to another.
- ◆ Stand-alone server — A NetWorker server that runs within a cluster, but not configured as a highly available application. A stand-alone server does not have failover capability.
- ◆ Virtual server — A NetWorker server configured to run as a highly available application. A virtual server can fail over from one cluster node to another.

Cluster-aware and cluster-unaware NetWorker servers

To perform scheduled backups within a cluster, you must have a cluster-aware NetWorker server and NetWorker client. Not all NetWorker servers and clients are cluster-aware. The *EMC NetWorker Software Compatibility Guides* provides information about which versions are cluster aware.

These issues apply if either the server or client are not cluster-aware:

- ◆ If a NetWorker *server* does not have cluster-client support, it cannot recognize cluster clients. When a scheduled backup is performed, the NetWorker server backs up only the private data of the physical node. The data is backed up to the same index representing the physical node.
- ◆ If a NetWorker *client* does not have cluster-client support, it backs up all data that belongs to the virtual servers and physical nodes into the same index representing the physical node. It does not recognize the difference between virtual and physical clients.

Cluster licensing

The new for 7.6 Service Pack 1, *NetWorker Licensing Guide* provides information on NetWorker licensing support for clusters.

Backing up data on Windows cluster environments

Note: If you manually stop a scheduled backup, the Manual restart option is set automatically, and overrides the Autorestart setting. For a NetWorker server to have failover capabilities within a cluster, you must enable the Autorestart setting. Disable the Manual restart option in the NetWorker Administration program to ensure that the scheduled backup restarts automatically.

The Manual restart option is enabled each time you stop a scheduled backup manually. Consequently, you must disable the Manual restart option each time you manually stop a scheduled backup.

Backing up cluster data

Backing up data from a node or a virtual server within a cluster is similar to backing up data on a computer that is not part of a cluster. For detailed instructions on how to back up data, see these chapters:

- ◆ [Chapter 4, "Backup Groups and Schedules,"](#)
- ◆ [Chapter 2, "Backing Up Data,"](#)

To prepare for backups, you must install the NetWorker software on all physical nodes in the cluster. The *NetWorker Installation Guide* provides details.

Note: You can back up all nodes and virtual servers in the cluster to a NetWorker server that is not part of the cluster.

Manual backup of a virtual client with non-administrative privileges

To perform a manual backup of data from a virtual client with non-administrator privileges, use the following command to modify the security descriptor properties on the cluster so that the user can access the cluster resources. Otherwise the data of the virtual client will be backed up under the physical node's index instead of the virtual client's index:

```
Cluster <ClusterName> /prop "security  
descriptor"=<DOMAIN\USER>,grant,f:security
```

Microsoft Cluster without Cluster Shared Volumes (CSV)

Cluster Shared Volumes (CSV) is a new failover clustering feature in Windows Server 2008 R2 that allows all nodes in a cluster, concurrent access to data on every CSV-enabled shared disk. CSV simplifies the configuration and management of clustered virtual machines. With CSV, multiple clustered virtual machines can use the same LUN (disk) while still being able to fail over independently.

NetWorker client on Windows Server 2008 R2 will not support CSV. If NetWorker detects configured CSV, it does not back up the CSV. It displays the following error message:

```
ALERT: This release of NetWorker does not support the backup of
Cluster Shared Volumes. The save_set_path directory and its contents
will not be saved.
```

NetWorker continues to backup the remaining files and directories.

Backing up node data

For a NetWorker client that corresponds to a physical node, NetWorker software can be configured to back up:

- ◆ Private disks
- ◆ SYSTEM and VSS SYSTEM save sets

To back up node data on a cluster client:

1. Create a client. [“Task 6: Create a backup Client resource” on page 59](#) provides more information.
2. Configure a Client resource for each cluster client in the cluster.
3. For the **Save Set** attribute:
 - To back up SYSTEM or VSS SYSTEM save sets, repair disk information, and all private disks on the client, enter **All**.
 - To back up only the local drives that exist on a client, specify the drive volumes of the private disks owned by the virtual client. For example, type:
C:\

Note: If you enter a drive letter for the Client’s Save Set attribute, rather than using All, the registry and repair information is not backed up. Make sure that the registry and repair information is backed up. These files are critical for successful disaster recovery.

Backing up virtual server data

On a virtual server, NetWorker software backs up only the shared disk data that exists on the virtual server. Virtual servers in the cluster become NetWorker virtual clients.

To back up virtual client data:

1. Create a client.
2. Configure a Client resource for each cluster client in the cluster.
3. For the **Save Set** attribute for the virtual client:
 - To back up all of the shared drives and active physical drives that exist on a client, specify **All**.
 - To back up only the drive volumes of shared disks that a virtual client owns, specify the drive volume letter. For example:
G:\
4. For the **Remote Access** attribute on the **Globals 2 of 2** tab, add each NetWorker client that corresponds to a physical node. For example:

```
SYSTEM@physical-client1
```

```
SYSTEM@physical-client2
```

If the virtual NetWorker server is listed in the `\nsr\res\servers` file, the physical nodes must also be listed there. A backup fails if a virtual NetWorker server is listed in the servers file and you create a savegroup to which a physical node is added that does not own the NetWorker Server resource.

To avoid this problem, do one of the following:

- ◆ Leave the servers file blank.

Note: If the servers file is blank, any NetWorker server can back up the client.

- ◆ Ensure that if the virtual NetWorker server is added to the servers file, all physical nodes are also added to the list.

Backing up data on EMC AutoStart

To perform a manual backup of data from a virtual cluster client with administrator privileges on EMC AutoStart on Windows, use the **ftconsole** to add nonroot users to the security access list for the FT domain.

Backing up the MSCS database

NetWorker software backs up the MSCS database as part of the SYSTEM STATE or VSS SYSTEM SERVICES save set. If you back up the SYSTEM STATE or VSS SYSTEM SERVICES save set, the cluster configuration is backed up automatically.

The MSCS database is maintained synchronously on two nodes. Consequently, backing up the database on one node might not reflect changes made on the other node.

Backing up data on UNIX cluster environments

This section describes how to configure scheduled saves of data from a physical cluster client and a virtual cluster client, as well as how to perform a manual backup of data from a virtual cluster client.

These topics provide more information:

- ◆ [“Configuring a scheduled save from a physical cluster client” on page 494](#)
- ◆ [“Configuring a scheduled save from a virtual cluster client” on page 495](#)
- ◆ [“Performing a manual backup from a virtual cluster client” on page 496](#)

Configuring a scheduled save from a physical cluster client

Backing up data from a physical client within a cluster is similar to backing up data on a computer that is not part of a cluster. [Chapter 2, “Backing Up Data”](#) provides detailed instructions on how to back up data.

To prepare for regular backups, install the NetWorker client software on all physical clients within the cluster. The *NetWorker Installation Guide* provides detailed installation and configuration instructions.

Configuring a scheduled save from a physical cluster client on HACMP

To back up a physical client on an HACMP for AIX node, each node requires persistent IPs or, for pre HACMP 4.5 clusters, an extra network interface card (NIC) that is configured outside of the control of the HACMP for AIX environment.

For a physical client, the NetWorker software requires an address that uniquely connects to a physical client. The service and boot addresses of HACMP for AIX do not meet this requirement because clusters configured with IP address takeover (IPAT), replace the boot address with the service address when a resource group is attached.

Service addresses are associated with a resource group, not physical nodes. The output of the **hostname** command on a computer must correspond to a pingable IP address. The computer hostname must also be set to the name equivalent of the address used by the physical client's persistent IP or dedicated NIC. With either method, persistent IP or dedicated NIC, the primary network adapter must be used (for example, en0).

Configuring a scheduled save from a virtual cluster client

Instructions for how to configure a scheduled save from a virtual cluster client are the same whether the NetWorker server is inside the cluster or outside the cluster.

To configure a scheduled save from a virtual cluster client under the NetWorker server:

1. (Optional) Define save groups as required.

Note: Save groups must have the **Autorestart** attribute enabled and the **Manual Restart** option disabled in order for their save sets to restart after a virtual client or NetWorker server failover.

2. Make each physical client within the cluster a NetWorker client of the NetWorker server.

For each physical client in the cluster:

- a. Create a new NetWorker Client resource.
- b. For the **Name** attribute, enter the name of the physical client.

3. Make each virtual client within the cluster a NetWorker client of the NetWorker server.

For each virtual client in the cluster:

- a. Create a new NetWorker client.
- b. For the **Name** attribute, enter the name of the virtual client.
- c. For the **Remote Access** attribute, add entries for each physical client within the cluster. For example:

```
root@clus_phys1
```

- d. For the **Group** attribute, select a group.

If you are using virtual NetWorker server that resides in a cluster, the first time the NetWorker server runs, it creates the Client resource for the virtual NetWorker server.

4. Run a test probe to verify that the Client and Group resources are properly configured.

On the cluster node or stand-alone server on which the NetWorker server resides, enter this command:

```
savegrp -pv -c virtual_client group_name
```

Note: [“Tracking scheduled saves” on page 503](#) provides information on if the test probe does not display the appropriate scheduled backups and index.

Performing a manual backup from a virtual cluster client

You can perform a manual backup of data from a virtual cluster client by using root and nonroot administrative privileges.

These topics provide more information:

- ◆ [“Perform a manual backup by using root administrative privileges” on page 496](#)
- ◆ [“Performing a manual backup by using nonroot administrative privileges” on page 496](#)

Perform a manual backup by using root administrative privileges

Backing up data from a virtual cluster client is similar to backing up data from noncluster clients. For example:

```
save -c client saveset
```

Performing a manual backup by using nonroot administrative privileges

For all cluster platforms except HP MC/ServiceGuard, AutoStart, and VERITAS Cluster Server, performing a manual backup by using nonroot privileges is similar to backing up data from noncluster clients by using root privileges. For example:

```
save -c client saveset
```

HP MC/ServiceGuard

To perform a manual backup of data from a virtual cluster client with nonroot privileges on HP MC/ServiceGuard:

- ◆ On each node on which you want to run the **save** command, edit or create the `.rhosts` file in your home directory to include the names of all the nodes within the cluster. For example:

```
nodeA
```

```
nodeB
```

- ◆ As root on all nodes in the cluster:
 - a. Edit or create the `/etc/cmcluster/cmclnodelist` file and add this information to the file:

```
nodeA user_name
```

```
nodeB user_name
```
 - b. Copy the file to each node in the cluster.

Note: If the `cmclnodelist` file exists, the cluster software ignores any `.rhosts` file.

AutoStart for AIX, HP-UX, Linux, and Solaris

To perform a manual backup of data from a virtual cluster client with nonroot privileges on AutoStart for AIX, HP-UX, Linux, and Solaris, use the **ftconsole** program to add nonroot users to the security access list for the FT domain.

VERITAS Cluster Server

You can perform a manual backup of cluster data that belongs to a physical or a virtual cluster client with nonroot privileges by using VERITAS Cluster Server (VCS) version 4.0 or lower. To do so, set the server's AllowNativeCliUsers attribute to 1. Setting this attribute ensures that the nonroot user is not prompted for a password when executing the server's commands. This attribute instructs the server to authenticate by using the user's operating system username and password, rather than the server username and password. The server default Cluster Guest permissions are sufficient to use the NetWorker client software.

In VCS version 4.1 or later, the AllowNativeCliUsers attribute has been deprecated. To perform a manual backup of cluster data that belongs to a physical or a virtual cluster client with nonroot privileges by using VCS version 4.1 or later, use the VCS **halogin** command. For more information about the **halogin** command, see the VCS documentation.

Note: When a nonroot user is running a NetWorker program such as **save** or **nsradmin** on a VCS cluster, the user must have permissions to query VCS. Otherwise, the NetWorker program will not be cluster-aware because the user is not authenticated by the VCS cluster. For information on how to set up VCS authentication, see the VCS documentation.

HACMP for AIX

To back up a physical client on an HACMP 4.5 node, each node requires persistent IPs or an extra NIC that is configured outside of the control of the HACMP 4.5 environment. For a physical client, the NetWorker software requires an address that uniquely connects to a physical client.

The service and boot addresses of HACMP 4.5 do not meet this requirement because clusters configured with IP address takeover (IPAT), replace the boot address with the service address when a resource group is attached.

Service addresses are associated with a resource group, not physical nodes. The output of the hostname command on a computer must correspond to a pingable IP address. The computer hostname must also be set to the name equivalent of the address used by the physical client's persistent IP or dedicated NIC. With either method, persistent IP or dedicated NIC, the primary network adapter must be used (for example, en0).

Configuring a virtual client to back up to a local storage node

Typically, the NetWorker server backs up the data on a virtual client within a cluster to the first storage node listed in the virtual client's Storage Nodes attribute.

You can configure a virtual client within a cluster to direct its backups to the storage node on the physical host on which it resides. To do this, type the following in the Storage Nodes attribute of the virtual client:

curphyhost

Note: **curphyhost** is only applicable to virtual clients and should never be inserted into the clone storage nodes list even for the NetWorker Server's NSR resource.

This is done by typing **curphyhost** in the Storage Nodes attribute of the virtual client.

For example, consider a two-node cluster where:

- ◆ Nodes A and B are the two physical nodes in the cluster.
- ◆ The virtual client is saturn, which can reside on Node A or fail over to Node B.

In a normal NetWorker backup of saturn—without “curphyhost” listed in the virtual client’s Storage Nodes attribute—the save data is directed to the remote device (rd=) on Node A. When saturn fails over to Node B and a backup for saturn is initiated, the save data is still directed to the remote device (rd=) on Node A.

Listing “curphyhost” first in saturn’s Storage Nodes attribute modifies the NetWorker operation so that if saturn fails over to Node B and a backup of saturn is initiated, the save data is directed to the remote device (rd=) on Node B. This action takes place because, after the failover, saturn resides on Node B—the current physical host.

Note: Do not apply the curphyhost keyword to your virtual server’s Client resource. This can cause unexpected behavior, such as bootstraps and online indexes being written to the local storage node for the virtual clients, rather than to a local device on the server.

Directing a virtual client backup to a local storage node

To direct a virtual client to back up to a local storage node:

1. Start the **NetWorker Administration Console** software.
2. From the **Administration** window, click **Configuration**.
3. In the left pane, select **Clients**.
4. From the **File** menu, select **Properties** and then select the **Globals 2 of 2** tab.
5. For the **Storage** nodes attribute, add the **curphyhost** keyword. Position the keyword in the list based on the required priority. The top of the list is the highest priority.

Configuring a virtual client to be recovered from a local storage node

The procedure to configure a virtual client to be recovered from a local storage node is similar to the procedure describe in [“Configuring a virtual client to back up to a local storage node” on page 497](#), except that this features is specific to a recover operation.

To configure a virtual client to be recovered from a local storage node, type the following in the Storage Nodes attribute or Recover Storage Nodes attribute of the virtual client:

currechost

With this keyword set, a request is made that the required volume be mounted on the storage node where the recover operation is running.

The following restrictions apply when configuring a virtual client to be recovered from a local storage node:

- ◆ Ensure that there are no hosts or machines named *currechost* on the network.
- ◆ The currechost keyword can not be set in the Clone storage nodes attribute of a virtual client.
- ◆ Do not apply the currechost keyword to the virtual server's Client resource.

Directing a virtual client recovery from a local storage node

To direct a virtual client to be recovered from a local storage node:

1. Start the **NetWorker Administration Console** software.
2. From the **Administration** window, click **Configuration**.
3. In the left pane, select **Clients**.
4. From the **File** menu, select **Properties** and then select the **Globals 2 of 2** tab.
5. For the **Storage nodes** attribute or the **Recover storage nodes** attribute, add the **currechost** keyword. Position the keyword in the list based on the required priority. The top of the list is the highest priority. Ensure that this keyword is not the only keyword in the list.

Recovering a virtual client's data by using the currechost keyword

To recover a virtual client's data by using the currechost keyword, run the recover operation on the node in the cluster where the virtual client resides. The NetWorker server requests that the volume be mounted on the local storage node.

Be aware of the following considerations when recovering the virtual client's data:

- ◆ Ensure that the local storage node has access to the required volume.
- ◆ If the required volume is in use by another drive, the recover operation waits until the volume is unmounted. When the required volume becomes available, the volume is mounted and the recover operation continues.

Support for multiple IP addresses for one resource group

NetWorker is able to save or recover a virtual client that has two or more IP resources on EMC AutoStart, HACMP, VERITAS Cluster Server, SUN Cluster, Microsoft MSCS, and Microsoft Failover Cluster.

The *EMC NetWorker Software Compatibility Guide* provides details on supported operating systems and cluster software versions.

Note: Support for multiple IP addresses in one resource group on AutoStart and HACMP is new and is available in the NetWorker 7.6.2 release. For VERITAS Cluster Server, this feature requires the creation of a NetWorker client resource for each resource group that contains two or more IP addresses.

AutoStart and HACMP clusters

In NetWorker 7.6 Service Pack 2, a virtual client that has two or more IP resources can be saved or recovered on AutoStart and HACMP clusters. A resource group can contain as many IP resources as is permitted by the cluster software. However, only one of these IP addresses corresponds to a NetWorker Client resource defined in a NetWorker server. The name of the NetWorker Client resource can be the short name, the FQDN corresponding to the IP address, or the IP address.

Example *resgrp1* is a resource group defined in a cluster and there are two IP resources defined in the group, *IP1* and *IP2*. If the IP address for *IP1* is defined as a NetWorker Client resource, then all shared paths in *resgrp1* are saved under the IP address for *IP1* index.

Do not configure both IP addresses as NetWorker Client resources. If this occurs, an error message displays indicating the save set has two owners defined as NWClient resources in the NetWorker server. To correct this:

- ◆ Remove one of the NetWorker Client resources.
- or
- ◆ Use the `-c` option to direct the client name.

Also, for recovery operations, if a path owned by two IP resources is recovered without specifying the client name, and both of the IP addresses are defined as NetWorker Client resources, the same error message displays.

Note: It is not supported to have more than one IP address for the resource group that makes the NetWorker server application highly available for HACMP and AutoStart clusters.

VERITAS Cluster Server

In NetWorker 7.6 Service Pack 2, a virtual client that has two or more IP resources can be saved or recovered on a VERITAS Cluster Server (VCS), just like a virtual client that has two or more IP addresses can be saved or recovered on AutoStart and HACMP clusters.

A resource group can contain as many IP resources as is permitted by the cluster software. The name of the NetWorker client resource can be the short name, the FQDN corresponding to the IP address, or the IP address.

You can configure more than one IP type resource for the NetWorker resource group on VCS. To support more than one IP resource, define a NetWorker client resource in the NetWorker resource group in VCS. This indicates the backup IP for the resource group. The NetWorker client resource is a customized resource type designed for VCS.

The NetWorker cluster installation guide provides details on how to configure an instance of the NetWorker client resource for a virtual client in VCS.

SUN Cluster

More than one IP address for a resource group (including the NetWorker server resource group) is supported on SUN Cluster. However, a customized resource type, LGTO.cnt for SUN Cluster is required for every resource group to be saved or recovered by the NetWorker software. LGTO.cnt is required whether the resource group contains only one IP address, or if it contains several IP addresses.

The NetWorker cluster installation guide provides details on how to create an instance of the LGTO.cnt resource for a virtual client on SUN Cluster.

Microsoft Cluster Server (MSCS) and Microsoft Failover Cluster

No matter how many IP addresses are defined in a resource group on MSCS or Microsoft Failover Cluster, as long as there is only one network name resource, then that network name should be specified as the NetWorker client to back up or recover the resource group.

If more than one network name is defined for a resource group on MSCS or Microsoft Failover Cluster, then the name property of the network name resource used for backing up the resource group must be configured to have a *NSR* prefix.

For example, suppose a resource group defined on MSCS, or on the Failover Cluster server, has two network names, *vclient1* and *vclient2*, whose resource names are *netname1* and *netname2* respectively. And, you want to use the network name *vclient1* to back up the resource group. Then, the following two configuration requirements must be met:

- ◆ The name of the NetWorker client resource for backing up the resource group should be *vclient1* but not *vclient2*.
- ◆ The resource name *netname1*, defined on the cluster, needs to begin with *NSR* (such as *NSR_netname1*). This can be done by using the following command:

```
cluster res netname1 /ren:NSR_netname1
```

Configuring an external client to a virtual server

Before a NetWorker server can back up a client, the client must grant the server access. Granting access is controlled by these files:

- ◆ On UNIX: /nsr/res/servers
- ◆ On Windows: <NetWorker_install_path>\res\servers

Only the specific servers listed in this file can back up the client. [“Adding or changing the NetWorker servers for a client” on page 486](#) provides more information about the servers file.

Recovering data in a Windows cluster environment

This section discusses how to recover data and cluster configuration in a cluster environment.

How to recover data

Recovering data backed up from a *private disk* that belongs to a physical client in a cluster is similar to recovering data on a computer that is not part of a cluster. [Chapter 13, “Recovering Data”](#) provides detailed instructions.

[“Directing recoveries to another client” on page 329](#) provides instruction on how to recover data from a shared disk belonging to a virtual client, and for instructions on completing a directed recovery.

The *NetWorker Disaster Recovery Guide* describes how to recover:

- ◆ Cluster configuration data.
- ◆ A corrupted Console database.

Recovering data in a UNIX cluster environment

This section discusses how to recover data from private disks belonging to a physical client and shared disks belonging to a virtual client.

Recovering data from a private disk that belongs to a physical client

Recovering data backed up from a *private disk* that belongs to a physical client in a cluster is similar to recovering data on a computer that is not part of a cluster.

[Chapter 13, “Recovering Data”](#) provides detailed instructions.

Recovering data from a shared disk that belongs to a virtual client

To recover data backed up from a *shared disk* that belongs to a virtual client:

1. Ensure that you have properly configured the virtual client for remote access from your current node:
 - a. From the **Administration** window, click **Configuration**.
 - b. In the left pane, select **Clients**.

- c. From the **File** menu, select **Properties** and then select the **Globals 2 of 2** tab.
- d. Make sure that the **Remote Access** attribute of the virtual client for which you want to recover the data contains the name of the physical host you are using to recover the data. For example:

```
root@physical_hostname
```

2. Make sure that the file systems of the virtual client are mounted.
3. Recover data from a shared disk that belongs to a virtual client.
 - To recover the data by using the **nwrecover** program, make sure that you select the virtual client.
 - To perform a command line recovery, enter the **recover** command with the **-c** option at the command prompt. The **-c** option must be followed by the name of the client you are attempting to recover. For example:

```
recover -s server_name -c virtual_client
```

The **recover** man page or the *EMC NetWorker Command Reference Guide* provide information.

Recovering the Console server database

The Console database contains management data such as report information. The *EMC NetWorker Disaster Recovery Guide* provides information about recovering a corrupted Console database.

Tracking scheduled saves

To verify that the Client and Group resources are properly configured, run a test probe for each client from the node where the NetWorker server is running:

```
savegrp -pv -c client_name group_name
```

If the test probe does not display all the scheduled save sets you want, do one of these and run a second test probe to verify the configuration:

- ◆ Check the cluster configuration by using the cluster management software. If necessary, reconfigure the cluster.
- ◆ Make sure that the client owns the save sets defined for that client. If necessary, redistribute the client save sets to the appropriate Client resources.

Note: Misconfiguration of the cluster resources might cause scheduled save sets to be dropped from the backup. [“Path-ownership rules” on page 504](#) provides more information about configuring clusters for scheduled backups.

To override scheduled save rules, create an empty file named `pathownerignore` on each node in the cluster by running this command:

```
touch "networker_bin_dir/pathownerignore"
```

This allows any path to be backed up for a client, whether it is owned by the virtual or physical node.

Note: Use the `pathownerignore` file with caution.

The `pathownerignore` file does not override the default path-ownership rules. It causes the path-ownership rules to be ignored when determining if a file system should be backed up during a scheduled save.

Forcing save sets to use a specific index

If you use `pathownerignore`, check that the NetWorker scheduled save uses the correct client file index. If it uses the wrong index, you can force save sets to go to a specific index.

To force save sets to use a specific index:

1. From the **Administration** window, click **Configuration**.
2. In the left pane, select **clients**.
3. In the right pane, select the client that is using the incorrect index.
4. From the **File** menu, select **Properties** and then select the **Apps & Module** tab.
5. For the **Backup Command** attribute, enter the name of a backup script that contains `save -c client_name`.

[“Using the save command with a customized backup script” on page 87](#) provides detailed information about the Backup Command attribute.

Path-ownership rules

In a cluster environment, the NetWorker software must distinguish between:

- ◆ File systems associated with a physical client.
- ◆ File systems managed by a resource group (a virtual client).

The criteria used are called the path-ownership rules. These rules determine which client file index a save set is written to.

By default, the NetWorker software might not back up scheduled save sets due to conflicts with path ownership. This prevents a virtual NetWorker client from writing to multiple client file indexes. The NetWorker software views the client (which owns the file system) as not having matched the client of the current scheduled save set. Writing to multiple indexes might cause recovery issues.

These conditions cause a file system to be omitted and *not backed up* during a scheduled save:

- ◆ If a file system owned by a virtual client is defined in the Save Set attribute for a physical Client resource.
- ◆ If a file system owned by a physical client is defined in the Save Set attribute for a virtual Client resource.

Administrative privileges

A user must have administrative privileges to query the cluster database. If a nonadministrative user performs a save of a file system that belongs to a virtual node, path ownership resolution fails and the files are saved under the physical node's client file index, instead of the virtual node's index. To force the NetWorker software to save the files under the virtual node's client file index, use the `-c` option. [“Forcing save sets to use a specific index” on page 504](#) provides details.

Checking path-ownership rules

To check the NetWorker path-ownership rules:

1. Type this command at the command-prompt on the NetWorker server:

```
savegrp -p -c client_name
```

2. Review which file systems *client_name* owns. This procedure is part of the normal cluster installation setup. The *NetWorker Installation Guide* provides details.

To test for misappropriated save sets, run a test probe with the **verbose** option set. The command output indicates to which client file indexes a save set is saved. For example:

```
savegrp -pv -c client_name group_name
```

To ignore NetWorker default path-ownership rules, you can create the pathownerignore file in the NetWorker bin directory:

- ◆ On Windows:

```
NetWorker_bin_dir
```

For example, C:\Program Files\Legato\nsr\bin

- ◆ On UNIX:

```
networker_bin_dir
```

This file causes the NetWorker software to back up the file system in question. However, the file system is saved under the client file index of its correct owner.

[“Forcing save sets to use a specific index” on page 504](#) provides information if a situation occurs when the scheduled save uses the wrong index.

Overriding path-ownership rules

Overriding the path-ownership rules causes a save set to be saved under a client file index different from the save set’s default owner.

How to override path-ownership rules during a manual backup

To override the default path-ownership rules for a manual backup, type the following at the command-prompt:

```
save -c client_name
```

How to override path-ownership rules during a scheduled backup

To override the path-ownership rules during a scheduled backup:

1. From the **Administration** window, click **Configuration**.
2. In the left pane, select **Clients**.
3. In the right pane, select the client that is using the incorrect index.
4. From the **File** menu, select **Properties** and then select the **Apps & Module** tab.
5. For the **Backup Command** attribute, enter the name of a backup script that contains `save -c client_name`.

[“Using the save command with a customized backup script” on page 87](#) provides detailed information about the Backup Command attribute.

Using a physical storage node and virtual server on UNIX platforms

This section describes how to access a physical storage node with a virtual NetWorker server.

A NetWorker storage node can be installed and configured on nodes in the cluster. However, the NetWorker storage node is not a highly available application. These instructions apply in the cases where you are using storage nodes in the cluster and storage nodes that are outside of the cluster.

Note: NetWorker release 6.0 and later does not officially support remote virtual storage nodes.

To access a physical NetWorker storage node from a virtual server (`rd=physicalhostname:devxxx`):

1. Shut down the virtual NetWorker server by using the cluster management software.
2. Modify the NetWorker virtual cluster **start** script to recycle the remote NetWorker storage node.

On each node to which the virtual NetWorker server can fail over:

- a. Open the NetWorker virtual cluster script, `networker_bin_dir`, for editing.
- b. Before the line that starts the **nsrd** daemons, add the appropriate script edits from [Table 93 on page 506](#), such as:

```
rsh remote_hostname "networker_bin_dir/nsr_shutdown -q &&
networker_bin_dir/nsrexecd"
```

Note: Replace the `networker_bin_dir` variable with the appropriate path where the NetWorker binaries are installed on the NetWorker storage node.

- c. If necessary, resynchronize the virtual NetWorker server **startup** script with the cluster management system.
3. Restart the NetWorker server.

Table 93 Script changes to support physical storage nodes(1 of 2)

Cluster product and virtual NetWorker cluster script	Edits for the virtual NetWorker server startup script
HACMP for AIX <networker_bin_dir>/nhwacmp.lc	<code>rsh remote_hostname "networker_bin_dir/nsr_shutdown -q && networker_bin_dir/nsrexecd"</code>
HP MC/ServiceGuard HP MC/LockManager <networker_bin_dir>/legato.monitor	<code>remsh remote_hostname "networker_bin_dir/nsr_shutdown -q && networker_bin_dir/nsrexecd"</code>
EMC AutoStart for AIX <networker_bin_dir>/nw_ux.lc	<code>rsh remote_hostname "networker_bin_dir/nsr_shutdown -q && networker_bin_dir/nsrexecd"</code>

Table 93 Script changes to support physical storage nodes(2 of 2)

Cluster product and virtual NetWorker cluster script	Edits for the virtual NetWorker server startup script
EMC AutoStart for HP-UX <networker_bin_dir>/nw_ux.lc	<code>remsh remote_hostname "networker_bin_dir/nsr_shutdown -q && networker_bin_dir/nsrexecd"</code>
EMC AutoStart for Linux <networker_bin_dir>/nw_ux.lc	<code>rssh remote_hostname "networker_bin_dir/nsr_shutdown -q && networker_bin_dir/nsrexecd"</code>
Sun Cluster <networker_bin_dir>/nw_ux.lc	<code>rsh remote_hostname "networker_bin_dir/nsr_shutdown -q && networker_bin_dir/nsrexecd"</code>

Using autochangers and stand-alone tape devices

This section describes how to use autochangers and stand-alone tape devices with a highly available NetWorker server. Device-sharing infrastructure is defined as hardware, firmware, and software that permit several nodes in a cluster to share access to a device.

Configurations for autochangers and stand-alone tape devices

If the cluster has a device-sharing infrastructure that supports autochangers and stand-alone tape devices. To configure your system to use:

- ◆ Shared autochanger devices and shared stand-alone tape devices, use [“Configuration option 1” on page 507](#).
- ◆ Shared autochanger devices, but *not* shared stand-alone tape devices, use [“Configuration option 2” on page 509](#).
- ◆ Nonshared devices, or any configuration, use [“Configuration option 3” on page 510](#), which does not require device-sharing infrastructure.

Note: Make sure that the device-sharing infrastructure is certified by the cluster software vendor.

Configuration option 1

This configuration option offers a seamless backup solution that is hands-free. It allows you to access shared tape devices and shared autochanger devices with a highly available NetWorker server. [Figure 33 on page 508](#) provides a graphical view of this configuration option.

Note: Only one autochanger is required, although you can add more.

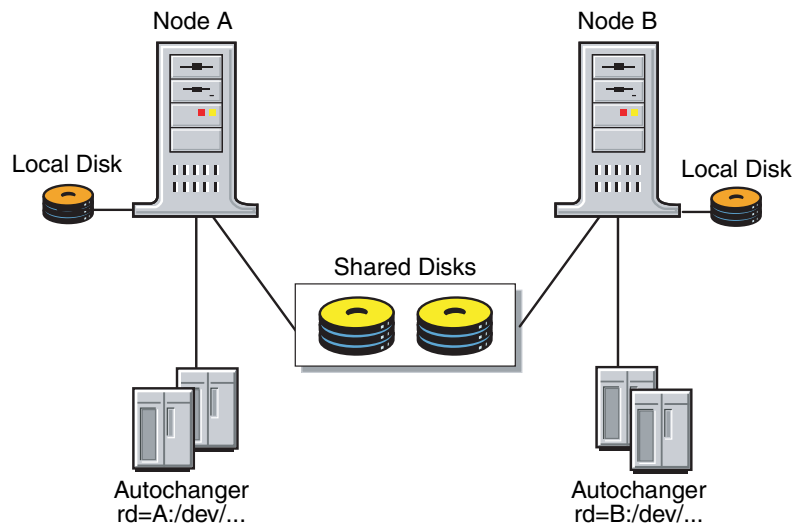

Figure 33 Configuration option 1

To configure shared tape devices and shared autochanger devices to work with a highly available NetWorker server:

1. Interface all the autochanger devices to all the nodes in the cluster to which the NetWorker server can fail over. Use a working SCSI or Fibre Channel switch, and appropriate software as required.
2. Make sure that the shared device infrastructure (SAN bridge, modular data router) supports complete isolation and protection of the path session between the autochanger and the node with the NetWorker server currently running. The path must be protected from stray bus signals and unauthorized session access from the other nodes.

Note: If processes on nodes other than the one that is running on the NetWorker server can access the tape devices, data corruption might occur. The NetWorker software might not detect the data corruption.

3. Modify the virtual NetWorker server startup script by adding any required node device-reassignment reservation commands (commands for the bridge) before the line that starts the **nsrd** daemon.
4. Test that the device-sharing infrastructure supports path isolation. For UNIX platforms, use the appropriate operating system commands for your platform against the device. For example, **tar** or **cpio**:
 - a. From Node A, write a significantly large amount of data to tape. During the write session, turn node B on and off a couple of times.

- b. Verify that the data was properly written by reading the data from tape and comparing it to the original data. [Table 94](#) explains the verification results.

Table 94 Data verification

Indication	Description
Failure	The switching infrastructure does not properly support path isolation. Try "Configuration option 2" or "Configuration option 3" , or contact the device-sharing infrastructure vendor.
Success	Reverse the node roles: <ul style="list-style-type: none"> From Node B, write a significantly large amount of data to tape. During the write session, turn node A on and off a couple of times. Verify that the data was properly written by reading the data from tape and comparing it to the original data. If the verification fails, try "Configuration option 2" or "Configuration option 3", or contact the device-sharing infrastructure vendor.

5. Configure the autochanger and tape devices.

Configuration option 2

This option offers a seamless backup solution for accessing nonshared tape devices and shared autochanger devices from a highly available NetWorker server. However, some intervention might be required during the data recovery process. [Figure 34 on page 509](#) provides a graphical view of this configuration option.

Note: If N nodes are used, $N-1$ storage node licenses are required. N indicates the number of failover nodes for the virtual NetWorker server.

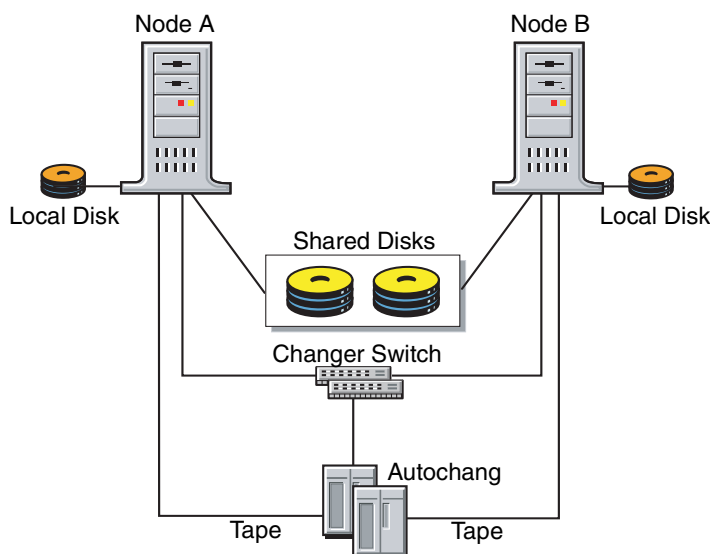

Figure 34 Configuration option 2

To configure the devices to work with a virtual NetWorker server:

- Interface the autochanger device to the NetWorker failover nodes. Use a working SCSI or Fibre Channel switch and appropriate software if required.
- Privately attach each tape device to a separate node within the cluster. For example:

- Attach tape drive 1 exclusively to Node A.
 - Attach tape drive 2 exclusively to Node B.
3. Configure the tape devices as remote physical storage nodes. For example:

On Windows:

```
rd=nodeA: \\.\Tape.0
rd=nodeB: \\.\Tape.1
```

On UNIX:

```
rd=nodeA: /dev/tape#1
rd=nodeB: /dev/tape#2
```

Note: When defining each tape device, assign ownership to the node exclusively connected to that tape device.

Configuration option 3

This option offers a seamless backup solution for accessing nonshared tape devices and nonshared autochanger devices from a highly available NetWorker server. However, some intervention might be required during the data recovery process. [Figure 35 on page 510](#) provides a graphical view of this configuration option.

Note: N indicates the number of failover nodes for the virtual NetWorker server.

- ◆ If N nodes are used, $N-1$ storage node licenses are required.
- ◆ At least N autochangers are required, one per failover node.

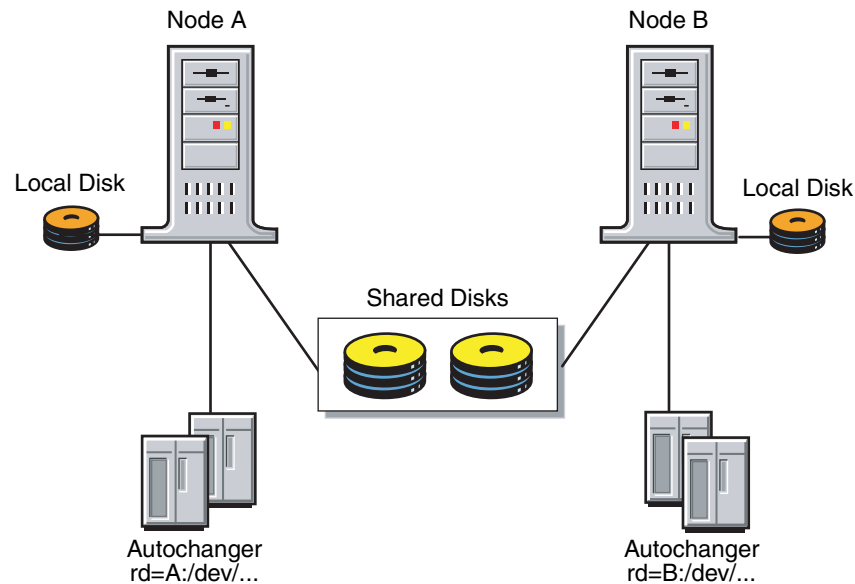

Figure 35 Configuration Option 3

To configure tape autochanger devices to work with a virtual NetWorker server:

1. Attach the autochanger exclusively to the NetWorker server.
2. Use this command to configure the nonshared tape and nonshared autochanger devices as remote physical storage node devices. For example:

On Windows:

```
jbconfig -s virtual_server
rd=nodeA:\\.\Tape.0
rd=nodeB:\\.\Tape.1
rd=nodeA:\\.\Tape.3
```

On UNIX:

```
jbconfig -s virtual_server
rd=nodeA:/dev/tape#1
rd=nodeB:/dev/tape#2
rd=nodeA:/dev/changer
```

3. Repeat these steps on each NetWorker server failover node.

DDS within a cluster

There are two options for using the DDS feature within a cluster:

- ◆ [“Controlling the robotics inside the cluster configuration” on page 511](#)
- ◆ [“Controlling the robotics from a stand-alone host” on page 513](#)

[“Dynamic drive sharing” on page 104](#) provides information explaining how to activate the DDS feature.

These sections explain the supported cluster platforms and the two methods for using DDS within a cluster.

High availability and DDS

The NetWorker software relocates and restarts operations that were in progress when a failure occurs on a cluster node. Currently, the only operations that are highly available are the NetWorker server and savegroups.

The nsrjb program high availability limitations

If the NetWorker server fails over from one node to a new target node, standard jukebox operations (such as performing an inventory, labeling, mounting or unmounting a volume) will not automatically restart on the new target node.

Example 42 Host crash requires user intervention

You have this scenario: two physical hosts, A and B, with DDS enabled, sharing the drives on an autochanger.

Physical host A mounts a tape in a shared drive on the autochanger. If physical host A subsequently crashes, the volume is held in that shared drive until you issue the **nsrjb -H** reset command (from host B, in this example).

This command unloads the drive and makes it available for future backups. The reset command clears the drive by accessing the device through another shared path. In this example, the other shared path would be on host B.

Successfully unloading a volume requires that the NetWorker software is able to access the same path through which the initial loading of the volume was completed.

Controlling the robotics inside the cluster configuration

To use DDS in a cluster, with the robotics controlled within the cluster configuration:

- ◆ One node must be a virtual NetWorker server. This virtual NetWorker server controls the robotics from within the cluster.

- ◆ Physical storage nodes of the cluster are configured to share the same drive.
- ◆ You must run the **jbconfig** program on the NetWorker server to install the autochanger.

To configure a highly available cluster, the special device file for the library robotics must be installed on all the physical nodes in the cluster. The special device file for the library robotics is provided by the cluster vendors. You must use the same naming convention across all the cluster nodes. For example, on a Windows cluster, the special device path would be `scsidev@1.4.0`.

Note: Some operating systems already have the special device file for the library robotics bound in. Essentially, these special device files represent a pointer to a generic tape or autochanger device driver. To determine whether the special device file has been bundled in with your operating system, run the **inquire** command.

If the special device files are not bundled in with the operating system, refer to the appropriate *NetWorker Installation Guide*.

Note: If you do not have matching special device files across cluster nodes, you may need to install fibre HBAs in the same PCI slots on all the physical nodes within the cluster.

With most cluster environments, the HBA can be configured to create the same scsi/FC path on each physical node of the cluster to make the NetWorker robotic control highly available. As a result, the `scsidev@bus.target.lun` will be identical for the robotics from each node in the cluster. [Figure 36](#) illustrates how DDS can be enabled within a cluster.

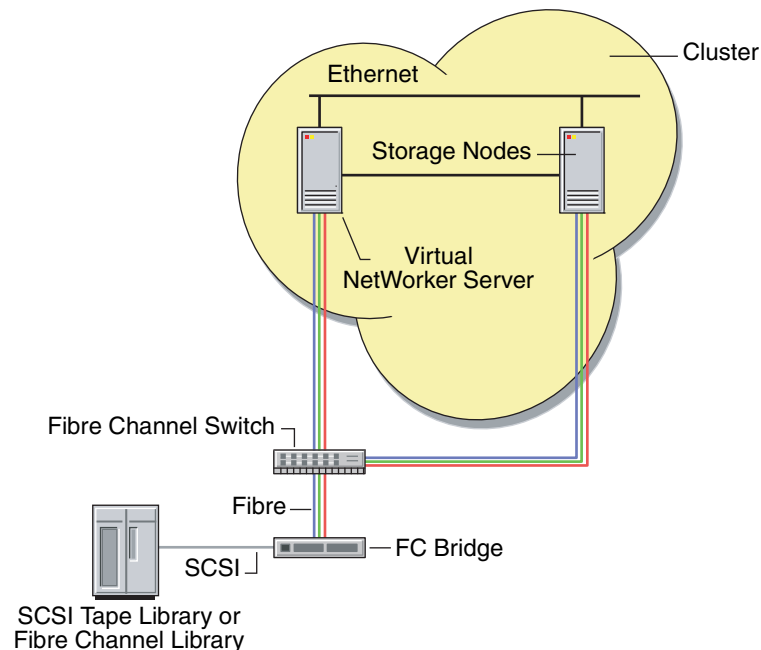

Figure 36 DDS enabled with robotics controlled in the cluster

Using the **jbconfig** program to control the robotics

To control the robotics, you must use the **jbconfig** program to configure the devices within the cluster. There are two options for using the **jbconfig** program to configure devices with a cluster.

- ◆ Using the **jbconfig** program *with* special device files
- ◆ Using the **jbconfig** program *without* special device files

The configuration process is similar in both cases, differing only at the prompt:

enter the control port of the jukebox in the following format

The prompt at which the response differs is illustrated in [Example 43 on page 513](#).

This is an example of the **jbconfig** script with appropriate responses:

```
jbconfig
1) Configure an AlphaStor/SmartMedia Jukebox.
2) Configure an Autodetected SCSI Jukebox.
3) Configure an Autodetected NDMP SCSI Jukebox.
4) Configure an SJI Jukebox.
5) Configure an STL Silo.
What kind of Jukebox are you configuring? [1] 4
Enter the number corresponding to the type of jukebox you are
installing:
1) ADIC-1200c/ADIC-1200d
2) ADIC-VLS
3) ARC DiamondBack
4) Sun 20Gb 4mm Tape Loader
.
.
.
45) Digital TL800
46) Digital TL810
47) Digital TL820
48) Digital TL893
Choice? 48
Installing an 'Digital TL893' jukebox.
What name do you want to assign to this jukebox device? juke_box_1\
```

At this point, the **jbconfig** program differs for configurations without vendor-supplied drivers and for configurations with vendor-supplied drivers.

Example 43 On Sun Cluster with no special device file

Using `scsidev@2.3.0` for the device, enter the following when using the **jbconfig** program:

```
Enter the control port of the jukebox in the following
format:scsidev@3.0.0
Pathname of the control port for the jukebox device? scsidev@2.3.0
```

Controlling the robotics from a stand-alone host

You can set up a stand-alone physical host outside the cluster to control the robotics, as follows:

- ◆ If you are unable to get a uniform nomenclature for the vendor-supplied drivers and you cannot match bus target LUNs across the cluster nodes.
- ◆ If you do not have a NetWorker server within the cluster.

Controlling the robotics from outside the cluster creates the opportunity for a single point of failure. Therefore, evaluate your requirements if you choose this method.

If you choose to have a stand-alone physical host controlling the robotics, you must ensure that the following binaries are installed:

- ◆ Client software
- ◆ Storage node software

- ◆ Driver software

You would configure the **jbconfig** program on the stand-alone physical host to control the robotics.

Figure 37 on page 514 illustrates one manner in which a stand-alone physical host outside the cluster can be used to control the robotics.

Note: The stand-alone physical host can control the robotics through a Fibre Channel or SCSI connection.

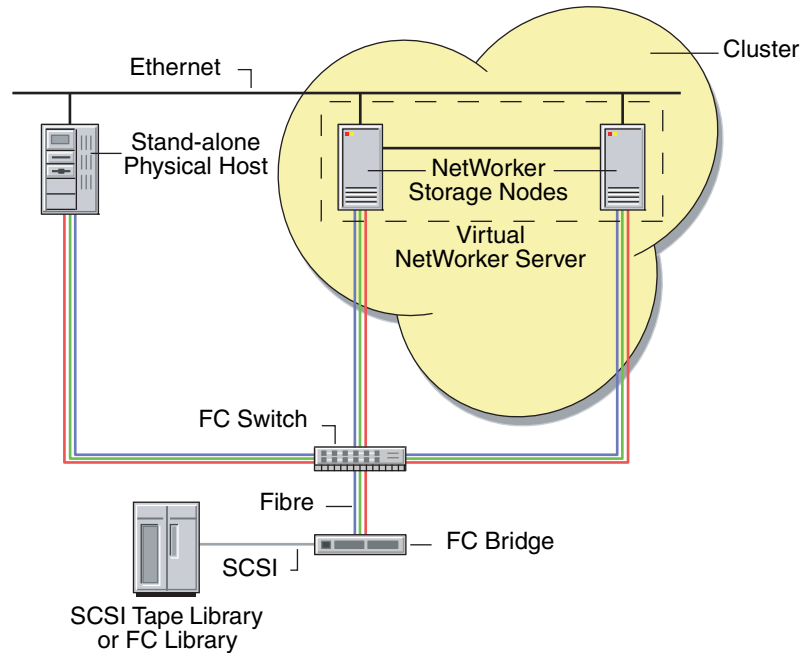

Figure 37 DDS enabled with the robotics controlled outside the cluster

Considerations when using **jbconfig** for a virtual server

While running the **jbconfig** command with the **-s virtual_server** option on the cluster node that is also running the virtual server, the name given to the *Prefix to the jukebox name* attribute has the following implications:

- If the virtual server name (default) is used for the Prefix to the jukebox name attribute, the jukebox's devices will be local to the virtual server.
- If the physical cluster hostname is used for the Prefix to the jukebox name attribute, the jukebox's devices will be local to the physical cluster host.

Controlling robotics from a NetWorker server on another cluster

A NetWorker server in a cluster can also be configured to control the robotics of the nodes of another cluster. This configuration is illustrated in [Figure 38](#). The virtual NetWorker server of cluster B controls the robotics for the physical storage nodes in cluster A.

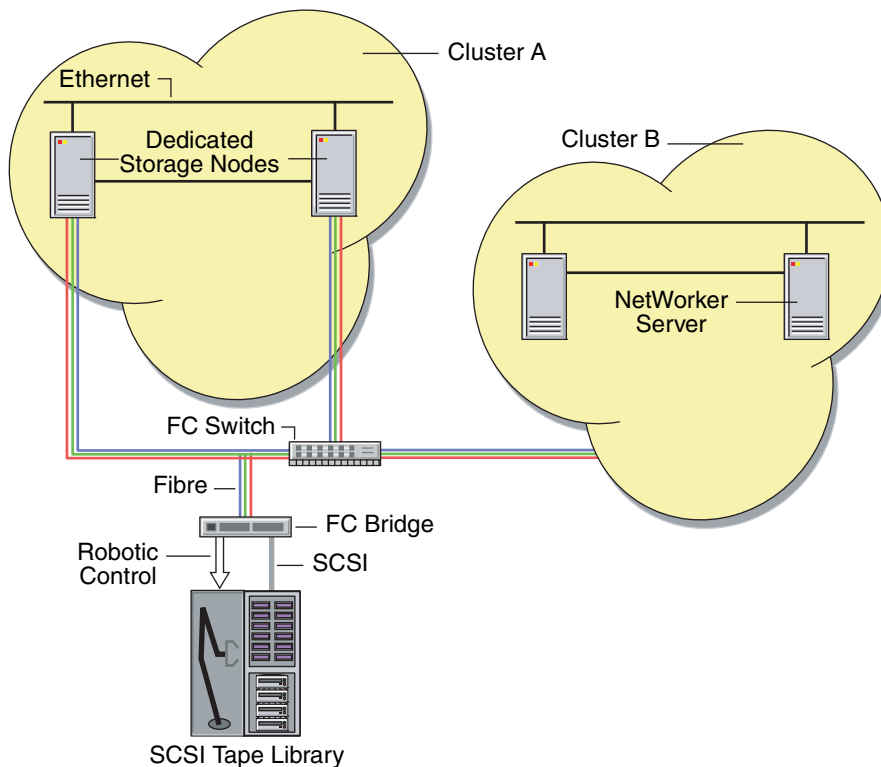

Figure 38 Robotics controlled between clusters

Client Backup Configuration Wizard support requirements

This section contains the requirements to use the Client Backup Configuration Wizard in a cluster environment.

- ◆ On a highly available NetWorker Server, the shared servers file must be updated with the `nsrwizcon.res` and `nsrwizclnt.res` files from the local servers file:
 - On UNIX:

```
cp /nsr.NetWorker.local/res/nsrwiz*res /nsr/res
```
 - On Windows:

```
copy c:\program files\legato\nsr\res\nsrwiz*res
<shared drive>: \nsr\res
```
- ◆ The host from which the wizard is being run and the NetWorker server host must be listed in both the local and shared servers file on the client host that is being configured for a scheduled backup.

“[Using the Client Backup Configuration Wizard](#)” on page 55 provides additional general considerations that apply to the Client Backup Configuration Wizard.

NetWorker cluster performance issues

The NetWorker program, **lcmmap**, queries cluster nodes to create a map that includes information such as path ownership of resource groups. In large cluster configurations, **lcmmap** may take a long time to complete and thus make certain operations occur slowly. This is most often noticed in slow NetWorker server (**nsrd**) start times or in very long backup times. In these situations, consider adjusting the NSRLA attribute named cluster cache timeout. This attribute specifies a time, in seconds, in which to cache the cluster map information on a NetWorker client.

Edit the cluster cache timeout attribute with caution. Values for the attribute can vary from several minutes to several days, depending on how often the cluster configuration changes, the possibility of resource group failover, and the frequency of NetWorker operations. Too large a value can result in an out-of-date cluster map, which can cause incorrect path resolution. For example, if the cluster cache timeout value is set to 86400 (one day), any changes to the cluster map will not be captured for up to one day. If cluster map information changes before the next refresh period, some paths may not be resolved correctly. Also be aware that too small a value could negatively affect performance because the cache is being updated too frequently. Experiment with one physical cluster node to find a satisfactory timeout value. If a significant improvement in performance cannot be obtained by adjusting this attribute, reset the attribute value to 0 (zero) so that the attribute will not be used.

Editing the cluster cache timeout attribute

The cluster cache timeout attribute is available only on NetWorker clients in a VERITAS Cluster or Sun Cluster environment. Additionally, the cluster cache timeout attribute resides in the NSRLA database of the NetWorker client and is visible only when NetWorker is configured for a cluster. For example on UNIX, a NetWorker client is configured for a cluster when the `networker.cluster` script is executed and **nsrexecd** is restarted.

Note: It is recommended that you edit the initial cluster cache timeout value before bringing the highly available NetWorker server online.

To edit the cluster cache timeout value:

1. Log in as root or as Windows Administrator on a physical node that is running the NetWorker client.
2. Type this at the command prompt:

```
nsradmin -p nsrexecd
```

The **nsradmin** prompt appears.
3. Display the current settings for attributes in the **NSRLA** resource, for example:

```
print type:NSRLA
```
4. Change the value of the cluster cache timeout attribute:

```
update cluster cache timeout:value
```

where *value* is the timeout value in seconds. A value of 0 (zero) specifies that the cache is not used.

Note: When modifying an attribute with the **nsradmin** program, the attribute name and value must be specified correctly. If the attribute name and value are not specified correctly, the attribute is not updated. No error message is provided.

5. Type **Yes** when prompted to confirm the change.
6. Perform the previous steps on each physical node in the cluster.
7. Bring the highly available NetWorker server online.

Unlike a standalone environment, there are two types of NSRLA databases when a highly available NetWorker server is configured in a cluster: a local NSRLA database on each physical node, and a shared NSRLA database on the highly available NetWorker server's shared disk. The previous steps set the attribute in the local NSRLA database on each physical node. Later when the highly available NetWorker server is brought online for the first time, it will get the cache timeout value from the local NSRLA database on the physical node where the highly available server is running.

8. The following steps are optional and can be used if you want to experiment with different cluster cache timeout values on the highly available NetWorker server.
 - a. Change the cluster cache timeout value in the shared NSRLA database by issuing the previous **nsradmin** commands (steps 2 to 5) on the physical node where the highly available NetWorker server is running.
 - b. The updated value will take effect after the next cache update, which is based on the previous timeout value. To make the timeout value take effect immediately, delete the cache file on the physical node. On UNIX, the cache file is located at `/tmp/lcmap.out`. On Windows, the cache file is located at `C:\Program Files\Legato\nsr\bin\lcmap.out`.
 - c. Once you have found a satisfactory value for the highly available server, you can also update the cluster cache timeout value on each physical node.

To update the local cluster cache timeout value on the physical node that is currently hosting the highly available NetWorker server, specify the location of the NSRLA database when using the **nsradmin** command, for example:

```
nsradmin -d directory
```

where *directory* is the location of the local NSRLA database. On UNIX, the directory is located in `/nsr.NetWorker.local/res/nsrladb`. On Windows, the directory is located in `C:\Program Files\Legato\nsr\res\nsrladb`.

Setting NetWorker environment variables in a Sun cluster

In a Sun Cluster environment, the `networker.start` script is used instead of the `/etc/init.d/networker` script to start the **nsrd** process.

NetWorker environment variables must be added to the `networker.start` script instead of `/etc/init.d/networker` script. Place the environment variables in the `networker.start` script before **nsrd** is started.

The `networker.start` script is located in the `/usr/lib/nsr` directory.

Changing the default timeout of 10 minutes for the NetWorker server in a Microsoft Cluster Server or Microsoft Failover Cluster

The default timeout for NetWorker server startup in a Microsoft Cluster Server or Microsoft Failover Cluster has been changed from 3 minutes per daemon to 10 minutes per daemon. You can now set the server's timeout value by modifying the `AdditionalArguments` field in the Parameters tab of the NetWorker Server cluster resource.

Note: Note: If you are upgrading from a version that does not allow you to set the default timeout to a version that does have this feature, you must re-register the NetWorker resource using `regnsrd`.

To set the timeout parameter for the NetWorker server startup:

1. In the Cluster Administrator program, select the resource group where the NetWorker Server resource exists.
2. In the Parameters tab of the NetWorker Server cluster resource, edit the value for the `AdditionalArguments` field.
3. Type the following keyword and add a value in seconds. For example:

```
ServerStartupTimeout=200
```

where *200* is a numeric value.

Note: The `ServerStartupTimeout` keyword is case sensitive. The time value is represented in seconds and must be a numeric value. If the entry for the time value is not recognized, the default of 600 seconds (10 minutes) is used for this variable.

This chapter covers these topics:

◆ Overview of NDMP	520
◆ Supported NDMP configurations.....	520
◆ Requirements for and limitations of NDMP support	525
◆ Configuring the NetWorker server for NDMP operations	529
◆ Performing NDMP backups	538
◆ Performing NDMP recoveries.....	545
◆ Snapmirror to tape backup and recovery	552
◆ NDMP cloning.....	554
◆ Ancillary product information	557

Overview of NDMP

“NDMP (Network Data Management Protocol)” is a TCP/IP-based protocol that specifies how network components talk to each other for the purpose of moving data across the network for backup and recovery.

NDMP enables disparate vendors to use a common NDMP protocol for the backup architecture. Data is copied from disk to tape or disk media, regardless of the operating system or platform. Tracking information is also passed to and from the backup software by using the same protocol, regardless of the software type.

NDMP works with the NetWorker software for backups, cloning, recoveries, and updates or queries to resource files. All communications are through NDMP.

The objective of NDMP is to address problems associated with backing up heterogeneous networks for operating system vendors, backup developers, and Network Attached Storage (NAS) devices.

NetWorker NDMP support includes library sharing and library management in a NAS environment. The term library is synonymous with autochanger, autoloader, carousel, datawheel, jukebox, and near-line storage.

Licensing

The NetWorker NDMP interface is an optional feature that must be licensed separately from the NetWorker base product according to a tiered licensing structure.

The new for 7.6 Service Pack 1, NetWorker *Licensing Guide* provides information on NetWorker licensing support for NDMP.

NDMP connection support

With the NetWorker NDMP interface, you can connect to hosts that have an active “NDMP service” or an NDMP data module installed. The hosts, clients, or devices (except for the NetWorker server) do not need to have the NetWorker software installed. NDMP allows a NAS device to back up data to other NDMP-controlled tape or disk devices on the network. The tape or disk device does not have to be directly connected to the NAS device. NDMP passes control of data and file metadata to and from the NetWorker program.

The respective vendor’s documentation provides information on how to install an NDMP data module or enable NDMP support on an application server.

Supported NDMP configurations

The NetWorker server with NDMP Connection supports these configurations:

- ◆ Local backup when using an NDMP Tape Server — The backup is performed to a tape device attached to the server where the data resides.
- ◆ NetWorker Storage Node — The backup is performed from an NDMP host to a NetWorker tape device, disk, optical, and other media type attached to a NetWorker storage node.

NetWorker storage nodes use a data server agent (DSA). DSA acts as an agent in the performance of backups between a NetWorker server and any client without NetWorker software. An example of a DSA is an NDMP host that generates

proprietary save data and sends that data to a NetWorker storage device to have a save set associated to it. Similarly, a DSA will act as an agent in the recovery between a NetWorker server and any client without NetWorker software.

Note: Any backup performed with the DSA feature has a D flag.

- ◆ Three-party that uses NDMP Tape Server — The backup is performed from one NDMP server to another NDMP server.

Local backup by using an NDMP tape server

A local backup with an NDMP tape server means the data being backed up is sent from the NDMP tape/data server (both on the same host) to its directly attached tape device or library. The data does not traverse the network, thus preventing network congestion.

With the local backup type, only metadata and NDMP control information (shown in [Figure 39 on page 522](#) as file history) traverse the network between the backup server and the NDMP tape and data server. The NetWorker program uses the file history information to maintain appropriate indexes and media databases.

[Figure 39](#) illustrates a local backup type configuration. The NDMP host is both an NDMP data service provider (DSP) and tape service.

The NetWorker server, or data management application (DMA) performs these tasks:

- ◆ Initiates the backup or recovery request through the NDMP connection.
- ◆ Receives the file history information from the data service and tape service.

The DSP performs these tasks:

- ◆ Receives the backup requests.
- ◆ Reads the backup data from disk.
- ◆ Produces a datastream for backup.

As a result, these actions occur:

- ◆ During a backup, the tape service reads a datastream from the DSP and writes it to tape.
- ◆ During a recovery, the tape service reads data from tape and generates an NDMP datastream.

The the following occurs:

1. The datastream is sent to the DSP.
2. The DSP reads from the datastream, and it to disk.

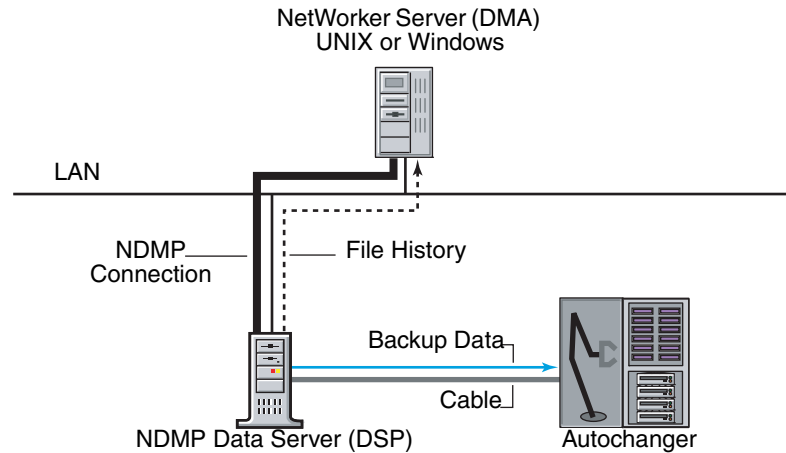

Figure 39 NDMP local configuration

Backup by using NetWorker storage node support

This section features the supported NDMP client backup configurations which use non-NDMP based NetWorker devices, such as a tape, disk, or optical.

Figure 40 on page 523 illustrates a NetWorker storage device attached directly to the NetWorker server. The NDMP backup that uses DSA, is initiated from the NetWorker server. NDMP save set data may be written to either a file type device or tape. Metadata, including file history, is processed in the NetWorker server (**nsrmmmd**).

Table 95 shows how DSA differs in use from NDMP tape server.

Table 95 Distinctions between NDMP tape server and DSA

NDMP Tape Server	DSA
Supports only NDMP type of tape device	Supports any type of NetWorker supported device.
Does not support backup to disk.	Supports backup to disk.
Does not support multiplexing.	Multiplexing is supported.
Record size is fixed for all device types, such as DLT7000, SDLT, Ultrium.	Record size varies with the type of device, which improves the write performances.

“Data write technologies” on page 542 provides information on storage technologies under NetWorker storage node support for NDMP clients.

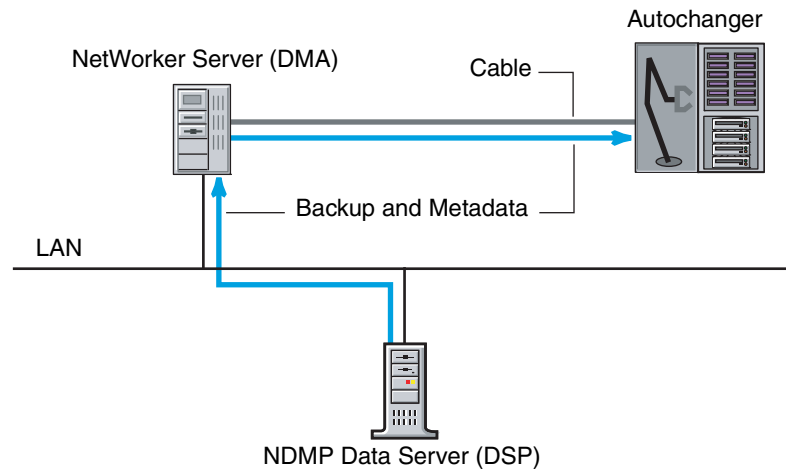

Figure 40 Backup Initiated from a NetWorker server with an attached storage device

Figure 41 on page 523 illustrates a NetWorker configuration in which the file history is backed up to the NetWorker server, and the data is backed up to the NetWorker client with an attached storage node. The backup command, `nsrndmp_save`, is run directly on the NetWorker client that has a NetWorker storage node locally attached.

Data is processed and saved to the NetWorker storage node, while the file history is processed on the designated NetWorker server (`nsrmmmd`).

After the data is backed up and sessions with the NDMP server and the NetWorker server are closed, the file history is committed to the NetWorker server.

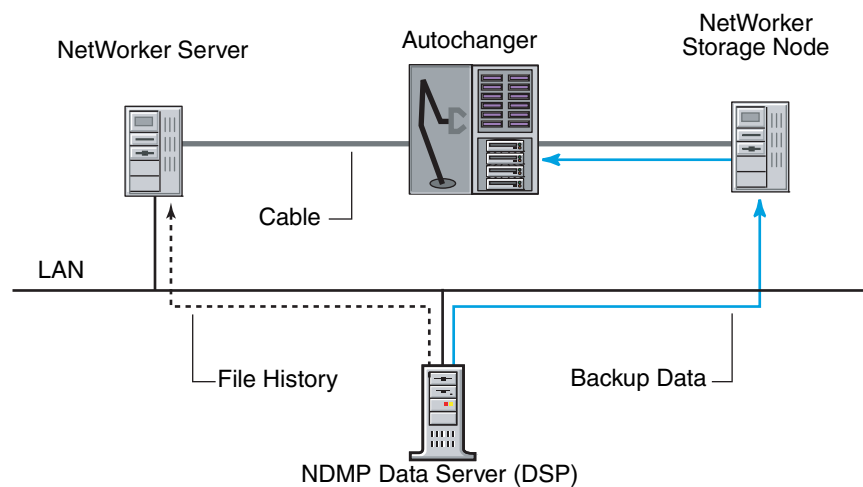

Figure 41 File history and backup data to NetWorker storage node

In [Figure 42 on page 524](#), the file history and data are backed up to the NetWorker server, which is also an EMC NetWorker SnapImage™ Module NDMP data server. In this configuration, the data server does a block-level backup.

The storage technology is the same as in [Figure 40 on page 523](#).

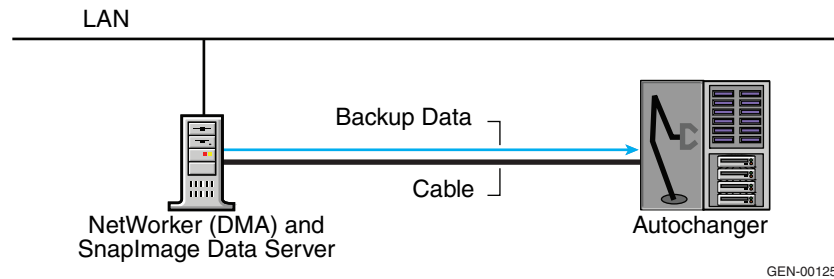

Figure 42 Backup that uses SnapImage module

Three-party backup with NDMP tape server

A three-party backup, also known as a three-way backup, is completed by using two NDMP servers. The data flows from the NDMP host (data service provider DSP) to the NDMP tape server, and then to the library that is locally attached to the tape server. The DSP might be an EMC, NetApp Filer, Auspex, or SnapImage Module.

Note: The two NDMP servers must be of the same type. For example, backups between an EMC NAS device and a NetApp server are not supported. A NetApp server must back up from, and recover to, another NetApp server.

[Figure 43 on page 525](#) demonstrates a three-party configuration, which enables backup and recovery to a NetWorker device that is attached to another NDMP server:

- ◆ One server is the data server.
- ◆ The second server is the tape server.
- ◆ The third party is the NetWorker server (DMA).

This configuration is similar to the flow of data between a NetWorker client and a NetWorker server or storage node, except that it is not necessary to install special software on either end. Data flows from the NDMP data server over the network to the tape server and then to tape. Metadata is sent from the data server to the backup server.

Supported tape servers

The NetWorker software with NDMP supports these tape servers:

- ◆ NetWorker NDMP TapeServer 2.0 software installed on the NetWorker server or another server.
- ◆ NetWorker SnapImage Module software installed on the NetWorker server or another server.
- ◆ DinoStor TapeServer connects one or more libraries to the network. This allows any NDMP host to be backed up to one location instead of requiring a local backup device for each server.

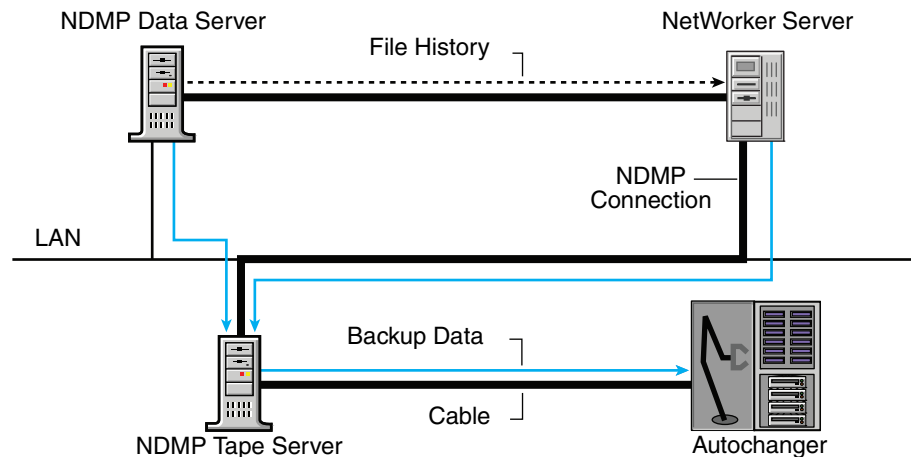

Figure 43 NDMP tape server

Requirements for and limitations of NDMP support

These sections contain information about requirements, support, and limitations of the NetWorker software for NDMP, including [“NetWorker storage node support for NDMP clients” on page 528](#).

Requirements for NetWorker software with NDMP support

These requirements apply when running the NetWorker software with NDMP support:

- ◆ To back up the bootstrap file, a non-NDMP device must be attached to the NetWorker server. The bootstrap includes the media database and configuration files needed to recover the NetWorker server after a disk crash.

This requirement does not apply when the backup is to a NetWorker storage node with a non-NDMP device. In this case, the same non-NDMP device could be used for a bootstrap device.
- ◆ To perform either an NDMP backup or recovery operation, you must be one of these:
 - Logged in as root
 - Windows Administrator
- ◆ The media device handle must be a nonrewind device handle.
- ◆ To perform parallel backups, perform one of these actions:
 - Specify multiple save sets in a single Client resource and verify multiple tape drives are available.
 - Specify multiple Client resources in separate groups (with one client/save stream in each group) are configured with the same start time for each volume to be backed up.
 - Specify Save Set All.
- ◆ When recovering data in a localized NDMP environment, the Index Recover status window shows the process in English, rather than the localized language.

Limitations of the NetWorker software with NDMP support

The addition of NDMP support to a NetWorker datazone environment renders these limitations:

- ◆ Other NDMP hosts cannot be browsed for backups. However, you can browse for save set recoveries by using the command prompt, the **NetWorker User** (Windows), or **nwrecover** (UNIX) program.
- ◆ Running the **scanner** command on a volume that has both NDMP and non-NDMP save sets.
 - Use a non-NDMP device path, an NDMP device path is not supported.
 - Use a local device for improved performance.
- ◆ The following features are not supported:
 - Archiving
 - Save set consolidation

Save set consolidation interprets save records on the media. The DSA does not write save records, hence the save set consolidation is not available. The DSA acts as an agent in the performance of backups between a NetWorker server and any client without NetWorker software that generates data and sends it to a NetWorker storage node or device to have a save set associated to it.
 - Cloning from NDMP tape device to non-NDMP tape device and vice versa
 - The **jbexercise** utility
- ◆ NetWorker Server resource attributes (**nsrmmd** polling interval, **nsrmmd** restart interval, and **nsrmmd** control timeout) do not apply to NDMP hosts, but they do apply when using NetWorker storage nodes for backup and recovery of data.
- ◆ The NetWorker software does not support the recovery options **Rename Recovered File** and **Discard Recovered File** for NDMP operations. For both save set and file-by-file recoveries, *current files are always overwritten*.
- ◆ The **scanner -i** command fails for DSA save sets and skips them. The **scanner -i** command is not supported for NDMP backups.
- ◆ The **SIZED1** flag is not supported with NDMP. This flag is set in the device configuration attribute, **Device tape flags**, which is displayed only in Diagnostic mode.
- ◆ The NDMP device block size should not exceed 256k for the NDMP backups to complete successfully.

Protocol limitations

These protocol limitations apply to versions 1 and 2 of the NDMP protocol:

- ◆ The Save Set attribute default All is supported for NDMP servers with NDMP version 3 or later.
- ◆ The library handle must be determined to run **jbconfig**.

Important notes on index processing and memory requirements

These notes concern the index processing and memory requirements and other information about NDMP backups that use NetWorker software.

Index Database

During an NDMP backup, the NDMP data server sends the file history metadata information to the NetWorker server. The **nsrndmp_2fh** binary starts processing the file history metadata immediately. The generation of the index database occurs at the end of the backup by the **nsrdmpix** binary. The file history metadata processing scales linearly with the increase in the number of entries (files) in the file system (save sets).

Especially during failover of a clustered NetWorker environment, if NDMP indexing is interrupted, the following results occur:

- ◆ The **nsrdmpix** binary will not automatically restart.
- ◆ The generation of the index database may be incomplete.
 - This means that a file-by-file recovery will not be possible.
 - A save set recovery may still be performed.

Memory requirements

The **nsrndmp_2fh** and **nsrdmpix** binaries interact with the raw database, instead of virtual memory, to process the file history metadata. Memory requirements for this process are minimal.

Temporary space required during Backup

To determine the required physical space for the default `\nsr\tmp` directory per file entry, use this formula.

$$2 * (144 + \text{average filename length}) * \text{number of entries in the file system}$$

Example 44 Calculating temporary space requirements

For one million file entries with an average filename length of 128, the required temporary swap space is computed with this formula.

$$2 * (144 + 128) * 1,000,000 = 544 \text{ MB approximately}$$

Changing the location of the temporary space directory

To change the location of the temporary space directory, provide a valid directory name as a value to the `NSR_NDMP_TMP_DIR` variable:

1. Change the application information in the Client window.
2. Set an environment variable.

This change moves the creation of the temporary files to that directory.

Potential error messages

If a backup or recovery fails due to an inadequate amount of swap space, error messages similar to the following appear:

```
Failed to store index entries
```

When the **nsrndmp_2fh** binary runs out of temporary space, this error message appears.

```
IO_WritePage write failed - No space left on device (28): No space left on device
```

The communication error between **nsrndmp_save** and **nsrndmp_2fh** results in this error:

```
error in reading the FH entries from save through stdin
```

NetWorker storage node support for NDMP clients

NetWorker storage node functionality includes NDMP save streams. NetWorker storage node software can be used for both NDMP and non-NDMP based backups in a unified fashion. For NDMP backups, NetWorker uses the DSA feature.

Clients that generate data have backup history in the form of manageable NetWorker save sets. These clients are referred to as NDMP clients.

Note: The DSA feature listens on a port number in the “service port range” of that system (DSA running host).

NDMP backups to non-NDMP based NetWorker devices

With this extension, NetWorker supports backup of an NDMP client to a non-NDMP based NetWorker device such as:

- ◆ Tape
- ◆ Optical
- ◆ Disk
- ◆ Other media types

Features with NetWorker storage node support for NDMP

NetWorker storage node support for NDMP backups include these features:

- ◆ Multiplexing
- ◆ Staging
- ◆ Coexistence of NDMP save sets with non-NDMP based NetWorker save sets
- ◆ Firewall support
- ◆ Availability on wide variety of platforms
- ◆ Auto media verification
- ◆ Backup to disk
- ◆ True NetWorker client support
- ◆ Cloning
- ◆ Direct Access Restore (DAR)

Save set flags in media database

The **mminfo** program (with the **-p** option to display a report on the browse and retention times for save sets) is used to view save sets. NetWorker storage node support for NDMP clients uses different flags with this program.

[Table 96 on page 528](#) lists the save set flags that are displayed by **mminfo** output and their meanings.

Table 96 DSA feature save set flags

Flag	Description
N	The client of the save set is an NDMP client.
s	The backup was performed to a NetWorker storage node by using DSA.
Ns	The backup was performed by an NDMP client to a NetWorker storage node by using DSA.

Performance

An increase in NDMP backup performance can be seen in several instances.

The NDMP tape server is limited to use 60 KB as the record size to write to the tape. For backup to non-NDMP devices, the size of the record depends on the type of the media involved. For instance, for an dlt8000 tape device, the record size is 128 KB. The backup speed increases when compared to the NDMP tape devices.

The **nsrndmp_save** command does not query the DSA every second to obtain the backed-up size and update the NetWorker Console, NetWorker User or **nwrecover** and **nsrmmd**, as it does the NDMP tape server while backing up to an NDMP tape device.

Note the following:

- ◆ Backup to disk improves the performance.
- ◆ Staging and cloning do not need to involve the NDMP tape server.

During a volume selection process, loading and positioning the volume does not occur. This is due to an exchange between **nsrmmd** and the **nsrndmp_save** or **nsrndmp_recover** commands. This exchange is an overhead situation, which is avoided by backing up to the NetWorker storage node.

Vendor-specific information

For information regarding the limitations, library configuration, and application information variables of each vendor, see [Table 97 on page 529](#).

Table 97 Vendor-specific information

Vendor	Refer to these links
Network Appliance	"Network Appliance" on page 558
Celerra	"EMC Celerra" on page 562
EMC IP4700	"EMC IP4700" on page 564
Auspex	"Auspex" on page 565
Procom NetFORCE	"Procom NetFORCE" on page 567
Mirapoint	"Mirapoint" on page 568
BlueArc	"BlueArc" on page 568
DinoStor	"DinoStor TapeServer" on page 569
SnapImage	"SnapImage or NDMP TapeServer Module" on page 570

Configuring the NetWorker server for NDMP operations

Before performing an NDMP backup, configure the NetWorker server for NDMP operations. Use the NetWorker Console Administration window to configure the resources listed in [Table 98 on page 530](#) on the NetWorker server before backing up data. Note that certain attributes of the resources are configured differently than for non-NDMP clients. ["Additional considerations for NDMP operations" on page 538](#) provides information on other configuration issues.

Note: Resources not listed in [Table 98 on page 530](#) should be configured the same as for non-NDMP operations.

Table 98 Configuring resources for NDMP

Resource	Configuration
Autochanger	Configure a library with the NetWorker Console Administration window. “Configuring library support for NDMP” on page 530 provides instructions. “Ancillary product information” on page 557 provides vendor-specific requirements.
Device	To use a stand-alone device, create a Device resource for NDMP backups. “Configuring an NDMP device resource” on page 534 . “Configuring library support for NDMP” on page 530 provides information on how to use a library.
Advanced File Type Device	Configure an advanced file device with the Administration window of the NetWorker Console.
Client	Create a Client resource with specific NDMP attributes. “Configuring an NDMP Client resource” on page 535 . “Ancillary product information” on page 557 provides vendor-specific requirements. To perform NDMP-based backups and recoveries, the Client resource must be set up with specific NDMP attributes.
Group	Add the NDMP client to a backup group. If the backup contains more than five million files, set the Inactivity Timeout attribute to zero (0). “Additional considerations for NDMP operations” on page 538 provides information on additional issues.
Schedule	Select a schedule for the NDMP client. NDMP supports level full and levels 1-9.
Policy	Specify the browse and retention policies for the NDMP client.

Configuring library support for NDMP

Before performing an NDMP backup or recovery, configure the libraries by using the server’s NetWorker Administration interface. Depending on the environment, the library handle may not be required to configure the library:

- ◆ If the NDMP host is running NDMP version 3 or later and supports NDMP_CONFIG interfaces, the library handle *is not* required to configure the library.
- ◆ If the NDMP host is running NDMP version 2 or earlier or does not support NDMP_CONFIG interfaces, the library handle *is* required to configure the library.

To determine if the NDMP host supports NDMP_CONFIG interfaces, refer to the appropriate vendor documentation.

Note: [“Configuring an NDMP device resource” on page 534](#) provides instructions on creating a Device resource for a stand-alone device.

Obtaining information about NDMP autochangers

Before the library can be configured for an NDMP backup and recovery, obtain the pathname of the media device. [“Ancillary product information” on page 557](#) provides instructions on obtaining the device pathname for a particular vendor.

Using the NetWorker Administration window with NDMP devices

To use the NetWorker Administrator window to search for available devices on the NDMP tape server:

1. From the **Console** window, click **Enterprise**.
2. Click the NetWorker server hostname.
3. Double-click **NetWorker**. The **NetWorker Administration** window opens.
4. Click **Devices**.
5. Right-click the **NetWorker Server**.
6. Select **Scan for Devices**.
7. Click the **Monitoring** button.
8. Click the **Devices** tab to view the device lists.

Using the inquire command with NDMP devices

Use the **inquire** command to search for available devices on the NDMP tape server.

The NDMP library information can be obtained two ways:

- ◆ From the location on the local server.
- ◆ On a specific NDMP host.

To obtain the NDMP library information:

1. Log in as root or as a member of the Windows Administrator's group.
2. Type this command.

```
inquire -N ndmp_hostname
```
3. Respond to the NDMP prompts as they occur.
 - a. Type the username.
 - b. Type the password for the NDMP host *hostname* (characters will not be echoed). The list of devices appears.

The *EMC NetWorker Command Reference Guide* or the UNIX man page provide more information on the **inquire** command.

IMPORTANT

Use the inquire command with caution. Running inquire sends the SCSI inquiry command to all devices detected on the SCSI bus. Using inquire during normal operations may cause unforeseen errors and possible data loss may result.

Configuring an NDMP autochanger

The NetWorker server's Administration interface and the NetWorker Autochanger resource configuration tool, **jbconfig**, are used to configure libraries for NDMP operations. Once the library is configured, the same interfaces are used to add or remove drives and devices.

[Chapter 3, "Configuring Libraries and Devices"](#) provides information on how to configure a library with the NetWorker server's Administration interface.

To configure a library with the **jbconfig** tool:

1. Determine the device pathname information for the NDMP library. “[Ancillary product information](#)” on page 557 provides information on how to obtain this information.
2. At the command prompt, change to the <NetWorker_install_path>\bin directory.
3. As root or as a member of the Windows Administrator’s group, type the following command:

```
jbconfig
```

The use of **jbconfig** requires an NDMP password for the computer with the attached tape device.

4. When prompted, select one of these options and answer the questions that appear:
 - If the library is connected to an NDMP tape server and the robot is controlled by the NDMP tape server, select the Autodetected NDMP SCSI Autochanger option.
 - If the NetWorker backup server or storage node controls the robot and shares the library with an NDMP tape server, select the Autodetected SCSI Autochanger option. Configure the tape drives to be used by the NDMP tape server.

Example 45 How to configure an NDMP autochanger for a NetApp computer

This partial example demonstrates how to configure an NDMP library for a NetApp filer by using the **jbconfig** program. The script uses the term *jukebox* instead of *library*. The terms are interchangeable.

Note: This example might not be valid for some NDMP hosts. To identify valid device names, refer to the NDMP host documentation.

```
jbconfig
1) Configure an AlphaStor/SmartMedia Jukebox.
2) Configure an Autodetected SCSI Jukebox.
3) Configure an Autodetected NDMP SCSI Jukebox.
4) Configure an SJI Jukebox.
5) Configure an STL Silo.
What kind of Jukebox are you configuring? [1] 3
Enter NDMP Server name: ? netapp-760-01
Enter NDMP user name: ? root
Enter NDMP password (characters will not be echoed):
Communicating to devices on NDMP Server 'netapp-760-01', this may take
a while...
```

When using NetWorker server’s Administration interface or the **jbconfig** program to configure an autochanger, a new resource is created with the name specified. View the new Library resource in the Libraries section of the NetWorker Console window.

The *EMC NetWorker Command Reference Guide* or the UNIX man page provide information on the **jbconfig** command.

[Chapter 3, “Configuring Libraries and Devices”](#) provides more information on the NetWorker server’s Administration interface.

Sharing libraries among NDMP clients

The NetWorker software permits the control and use of individual devices within a library to different NetWorker hosts within a datazone. If only NDMP hosts have access to a library, the autochanger has to be defined as NDMP. In this situation, the tape drives within the library can still be shared and controlled by one host, and shared by the other hosts.

Robotic arm control

The library is configured for sharing during the initial library setup by using NetWorker server's Administration interface or the **jbconfig** program.

The **jbconfig** program must be run from the NetWorker server if the robotic arm is owned by the server or an NDMP host, or from a standard storage node if that node owns the robotic arm. The **jbconfig** program provides the following options.

- ◆ If the NetWorker server owns the robotic arm, run **jbconfig** from that server and choose **Autodetected SCSI Autochanger** when prompted.
- ◆ If an NDMP host owns the robotic arm, run **jbconfig** from the NetWorker server and choose **Autodetected NDMP SCSI Autochanger**.
- ◆ If a standard storage node owns the robotic arm, run **jbconfig** from that node and choose **Autodetected SCSI Autochanger**.

While running **jbconfig**, identify the following when prompted.

- ◆ The NetWorker hostname and device path of the server that controls the first library device.
- ◆ The controlling host for *each* device in the library.

Example 46 Robotic arm control

In a three-drive library shared among two NDMP hosts and a NetWorker server, Host1 controls the arm and the first drive.

- ◆ When prompted for the owner of Host 1, specify the hostname:device path for Host 1 as the host controlling the library device.
- ◆ When prompted for the owner of Drive 2, specify the hostname:device path for Host 2 for the owner of Drive 2.
- ◆ When prompted for the owner of Drive 3, specify the NetWorker server hostname:device path.

[Chapter 3, "Configuring Libraries and Devices"](#) provides more information on sharing libraries.

DDS support with NDMP

The NetWorker software includes support for DDS, which provides the capability to recognize shared drives. DDS enables NetWorker software to skip the shared drives that are in use and route the backups or recoveries to other available shared drives. For a list of NDMP disk and tape services that support DDS with the NetWorker software, refer to the *EMC NetWorker Software Compatibility Guide*.

The DDS feature may be enabled when configuring a library through the **jbconfig** program. [Chapter 11, "Device Operations"](#) provides more information about DDS Support with NDMP.

Enable the DDS feature

To enable DDS:

1. When prompted by the **jbconfig** program whether the drive is to be shared, type:
Yes
2. When prompted, assign a hardware ID.
3. Respond to the prompts as required for the first host to have access to the shared drive.
4. When prompted whether this drive is to be shared with another host, type:
Yes
5. When prompted, type the hostname and device path of the second host to have access to the shared drive.
6. Complete the prompts for the second device.

All the components of a SAN configuration must be compatible when DDS is enabled with the NetWorker NDMP feature.

- ◆ The Fibre Channel switches must be compatible with any NDMP hosts within a SAN.
- ◆ NDMP hosts and libraries in the SAN must also be compatible with each other.

[Chapter 3, “Configuring Libraries and Devices”](#) for additional information about standard DDS

Running nsrjb to load tapes

If **nsrjb** is run to load a tape, include the **-f** option and **rd** syntax in the device name. For example, if the NDMP hostname is *nas1* and the device is *nrst0a*, and a tape is to be loaded from slot 1, this syntax for loading a tape into that drive is used.

```
nsrjb -l -f rd="nas1:nrst0a (NDMP)" -s 1
```

Using nsrjb to load volumes in a jukebox connected to an NDMP server

To load the volume in slot 1 of jukebox *mylibrary* (connected to NDMP server *10.31.32.220*), use the **-J** and **-j** options.

```
nsrjb -J 10.31.32.220 -j mylibrary -l -s 1
```

Silo support

A NetWorker server with NDMP enabled supports silos controlled by either ACSLS or DAS controllers. Any silo behind the ACSLS or DAS is supported, since all robotic control and communication is done by ACSLS and DAS, which receive commands through TCP/IP from the NetWorker server.

Configuring an NDMP device resource

[Chapter 3, “Configuring Libraries and Devices”](#) provides details on how to configure the Device resource in the standard, non-NDMP NetWorker software. This section provides instructions for configuring the Device resource information when using a stand-alone device with NDMP.

The **jbconfig** program creates the NDMP device for NDMP devices in a library.

To configure an NDMP device (for non-storage node NDMP support) in the **Administration** window of the NetWorker Console:

1. In the **Administration** window, click **Devices**.
2. Right-click **Devices** in the navigation tree, and select **New**.
3. Complete these attributes in the **Create Device** window:
 - a. For the **Name** attribute, specify the NDMP device by using this syntax:

```
rd=NDMP_computer:tape_device_pathname (NDMP)
```

Note: You must add (NDMP) after pathname. If you do not add it, you will receive the following error message:
NDMP device name shall be in rd=<snode>:<devname (NDMP)> format
 - b. Set the **Target Sessions** attribute to **1**. Multiplexing is not supported on NDMP computers.
 - c. Complete the other attributes in the same manner as a non-NDMP client.
4. On the Configuration tab, complete these new device attributes:
 - a. Select the checkbox to set the **NDMP** attribute. This attribute can only be set when creating the device. The NDMP attribute cannot be changed after the device has been created. To change the device configuration, first delete the configuration, then re-create it.
 - b. For the **Remote User** attribute, type the NDMP account username for the computer where the NDMP library robotics or tape device resides.
 - c. For the **Password** attribute, type the password for the NDMP user account. This password should match the password for the NDMP user account for the computer where the NDMP library robotics or tape device is installed.
5. Complete any other attributes in the same manner as a non-NDMP NetWorker device configuration.

Note: When configuring an NDMP Device resource, the Dedicated Storage Node attribute must be set to its default value of **No**. A dedicated storage node cannot be used with the new NDMP DSA feature, as a dedicated storage node will not work with `nsrdsa_save`. [“Tips for troubleshooting storage nodes” on page 103](#) provides information about the Dedicated Storage Node.

Configuring an NDMP Client resource

[“Task 6: Create a backup Client resource” on page 59](#) provides information on creating a Client resource for non-NDMP operations. This procedure covers issues related to specific attributes of the Client resource that are affected by NDMP.

To create an NDMP client in the Client resource:

1. From the **Administration** window, click **Configuration**.
2. In the expanded left pane, select **Clients**.
3. On the **General** tab, complete the following attributes:
 - a. For the **Name** attribute, type the client name.
 - b. For the **Save Set** attribute, list the file systems to be backed up. To back up all of the client’s file systems, specify **All**.

Note: If the NDMP server is running a version earlier than 3, the value **All** is not supported. The file systems must be listed manually.

To back up large client file systems, optionally schedule each file system to back up separately. For example, create two separate clients with the same name, but with different save sets.

- c. Complete the other attributes in the same manner as for a non-NDMP based backup.
4. On the **Globals (2 of 2)** tab, specify the appropriate storage node in the **Storage Nodes** attribute, depending on the type of backup to be performed:
 - For a local backup, type the NDMP server name to which the tape device is attached, listing this server first, unless **-M** is a parameter, in which case list the storage node hostname first.
 - For a three-party backup, list the destination server for the data being backed up first. The client backs up the data to each NDMP server or storage node in the order in which they appear in the attribute.

Complete the other attributes in the same manner as for a non-NDMP based backup.

5. On the **Apps and Modules** tab, complete the following attributes:
 - a. For the **Remote Access** attribute, list all computers that will store and retrieve entries for the client. In addition, list any computer that is used to browse entries for the NDMP computer. Since the NetWorker server stores the client file index entries for the NDMP computer, be sure that administrator@server is listed.
 - b. For the **Remote User** attribute, type the NDMP account username for the computer where the NDMP data module is installed. If this is administrator, be sure that the administrator has a password.
 - c. For the **Password** attribute, type the password for the NDMP user account. This password should match the password for the NDMP user account for the computer where the NDMP data module is installed.
 - d. For the **Backup Command** attribute, set the value as follows:
 - For use with NDMP Tape Server:
 nsrndmp_save -T backup_type
 - For use with storage node:
 nsrndmp_save -s server -c client -M -T backup_type
 - To back up an NDMP client to a non-NDMP device, use the **-M** option.
 The value for the NDMP backup type depends on the type of NDMP host. For example, NetApp, EMC, and Procom all support **dump**, so the value for the Backup Command attribute is:
 nsrndmp_save -T dump

For a list of backup values supported by a particular NDMP host, refer to the appropriate vendor documentation.
 - e. For the Application Information attribute, list the NDMP environment variables. [“Specifying application information” on page 537](#). provides a list of the variables and rules for typing their values.

The *NetWorker Command Reference Guide* or the UNIX man page provide information on the `nsrndmp_save` command.

6. On the **Miscellaneous** tab, select **Yes** for the **NDMP** attribute.

Note: Unless Yes is selected, the client will not be able to perform backups and recoveries. Any NDMP operations involving a non-NDMP client would have to be run from the NetWorker server. A non-NDMP client has no `ndmpd` service (or daemon) to connect to the server or another NDMP target client for a directed recovery.

7. Complete any other attributes appropriate for a NetWorker client configuration.

Specifying application information

In the Application Information attribute, list environment variables that the NetWorker server uses for an NDMP backup. For the backups to be successful:

- ◆ Separate the environment variable name from its value with an equal (=) sign, for example:
`HIST=y`
- ◆ Type each environment variable in the Application Information attribute on a separate line.
- ◆ Click **Add** after each entry.

The values typed depend on the NDMP host.

Required variables for all NDMP hosts

The following application variables are required for all (or most) NDMP hosts.

- ◆ `UPDATE=y`
UPDATE forces the timestamp information to be updated with the time, date, level, and file system that is being backed up. This value must be set to `y`. If a file system is backed up at the same level as its previous backup, the old timestamp information entry is overwritten with the new information.
- ◆ `HIST=y`
HIST determines whether a file history is created and required for index recovery. This value must be set to `y`. This is also the default setting.

Note: For Mirapoint, this value must be set to `n` to deactivate creation of a file history during a backup. The `(fromimagefull=)` option informs level backups about the date of the last full backup. [“Mirapoint” on page 568](#) provides more information.

Additional considerations for HIST=Y

When `HIST=n`, NDMP backups with NetWorker 7.2 and later are always run at level FULL, even with a correct schedule and `UPDATE=y` (for more information, refer to [“UPDATE=y” on page 538](#)).

A level FULL scheduled backup is performed if there is no previous fully browsable version of the same save set. Furthermore:

- If `HIST=y`, full and successive level backups perform properly.
- If `HIST=y` and at least one browsable save set exists, then future level backups of the same save set will back up at the specified level correctly.

- If HIST=n and no previous browsable backups of the save set exist, then all backups will be at level full, regardless of level specified. If there was at least one time this save set was backed up with HIST=y, all future HIST=n backups will be backed up at the correct level, not otherwise.
- With NetWorker 7.2 and later, if HIST=n (other variables being DIRECT=y and UPDATE=y), then all backups are performed at a level FULL, regardless of the level specified. Note that the index backup is performed at LEVEL 1, but the data is always at level FULL.
- The behavior is the same with NDMP DSA and non-DSA NDMP 3. If the level 1 backup is forced outside of NetWorker using `nsrndmp_save -T` with the `-l1` option, then a LEVEL 1 backup is performed.

Note: The environment variables are case-sensitive. Check with the vendor for the latest information on supported values.

[“Ancillary product information” on page 557](#) provides application information variables for a specific vendor, see the particular vendor section. These values were correct at the time of publication and *must* be set before a backup is performed. For the latest information, check with the NDMP vendor.

Additional considerations for NDMP operations

These sections provide information about various NetWorker settings to modify for NDMP operations.

Savegroup parallelism setting for NDMP tape server

By default, savegroup parallelism is set to zero, so the NetWorker server uses the value of the client parallelism. Rather than depending on client parallelism, set the Savegrp parallelism attribute for NDMP group backups to equal the number of available NDMP drives. If the Savegrp parallelism attribute is set to a higher value, there will not be enough drives to support all the save sets that are queued for a backup. Large save sets may fail due to the Inactivity Timeout limit. In addition, if more than one group is being backed up simultaneously, divide the number of drives by the number of groups. Use that value for each of the Savegrp parallelism attributes.

Performing NDMP backups

This section describes backups that use configurations with the NDMP Tape Server and storage node support for NDMP.

Tape server support for NDMP client backup

These sections describe how to perform an NDMP backup by using the `nsrndmp_save` command, NetWorker User, or the `save` program. The *EMC NetWorker Command Reference Guide* or the UNIX man pages provides details. The `nsrndmp_save` command is used in NDMP operations. This command supports most of the same arguments as `save` by referencing the UNIX man page. The `-T backup_type` option within `nsrndmp_save` identifies the NDMP backup type.

Prerequisites

Before performing a test backup, ensure that the following actions have been performed:

- ◆ Enable the NDMP Connection.
- ◆ Add the NDMP host to a backup group.
- ◆ Select a backup schedule with browse and retention policies.
- ◆ Select a volume pool for the data.
- ◆ Install an NDMP data module or enable the application server for NDMP operations. File systems on hosts without an NDMP data module cannot be backed up through the NetWorker NDMP Connection.
- ◆ Configure a non-NDMP device to back up the bootstrap and index information. If data is to be cloned, a second non-NDMP device must be configured to receive the cloned bootstrap and index information. Note that the index and bootstrap information is generated only if the scheduled group is backed up manually or through the schedule.

Perform the test backup by running a scheduled group backup.

Locale settings with NDMP

When running NDMP backups, the locale setting has to be consistent in your environment. All UNIX flavored locale settings on the filer (including UTF-8) must be the same and the NMC client can be run only on a UNIX client set to the exact same locale setting as the filer. Backup and recovery operations can be run on any locale, but if you try to browse on a locale that is different from the original locale the filenames appear as random characters.

Performing a local backup by using the NetWorker User program

Use this program to perform a local backup that is not scheduled. A three-party backup *cannot* be performed with this program.

To perform a local backup:

1. In the NetWorker **User** program, click **Backup**.
2. In the **Backup** browse window, select the directories or files to be backed up.
3. To mark the files or directories for backup, click **Mark**.
4. To start the backup, click **Start**.

Performing an NDMP backup from the command prompt

Initiate NDMP backups from the command prompt by using the `nsrndmp_save` command. To browse files or directories that have been backed up, use the NetWorker User program, `nwrecover`, or the `recover` command.

Note: Configure the client in the Administration window of the NetWorker Console before performing a backup from the command prompt.

To perform a backup from the command prompt, use this syntax:

```
nsrndmp_save -T backup_type -s server_name -c client_name
-l backup_level -N name -g save_group -W width -LL local path
```

where the `-T` option is the type of backup on the NDMP server, for example, *celestra*. The *EMC NetWorker Command Reference Guide* or the UNIX man page provide information on the `nsrndmp_save` command.

During backup and recovery operations, the NDMP host provides information on the amount of data moved. This status information is passed back to the NetWorker server and can be accessed through the NetWorker Console.

Note: When backups are performed through the `nsrndmp_save` command, the bootstrap is not automatically backed up. Without the bootstrap, a disaster recovery of an NDMP host cannot be performed. To perform a bootstrap recovery of an NDMP host, use the `savegrp -G group_name` command to back up the data. This command runs the specified backup group as if it were initiated from within the NetWorker server. All environment settings specified for that group, such as clients, pools, and schedules, are used.

Performing an NDMP DSA backup from the command prompt

Initiate NDMP DSA backups from the command prompt by using the `nsrndmp_save` command with the `-M` option.

To perform a backup from the command prompt, use the following syntax.

```
nsrndmp_save -T backup_type -s server_name -c client_name
-I hostname -l backup_level -M -N name -P hostname
-g save_group -W width -LL local_path
```

where

- ◆ The `-M` option designates a backup to a non-NDMP device. The NetWorker software selects a storage node that has non-NDMP devices only. If there is more than one, ascending order is used.
- ◆ The `-P hostname` option designates a host for the non-NDMP based backup.
 - This option is valid only if the `-M` option is also present. If this option is absent, then the host is assumed to be the host that is local to the `nsrndmp_save` command. This `hostname` must be a valid NetWorker client and should be listed in the remote access list of the NDMP Client resource.
 - Unless the hostname of the client initiating the backup is added to the host for the non-NDMP based backup's `/nsr/res/servers` file (UNIX example), the backup will fail.

Performing a three-party backup from the command prompt

Three-party backups involve two NDMP servers. [“Three-party backup with NDMP tape server” on page 524](#) provides details.

Note: For instructions on performing a remote backup, see [“How to perform a remote backup with the SnapImage/NDMP TapeServer software” on page 571](#).

To perform a three-party backup:

1. Set up the servers as demonstrated in [Figure 43 on page 525](#).
2. Install the NetWorker software on the server designated as the NetWorker server.

Note: If the NetWorker storage node is involved in a configuration which uses a conventional tape or disk device, then the bootstrap and file history can be saved conventionally. There is no need then for additional setup and explicit definition for the NDMP storage device.

3. Configure the NetWorker server:
 - a. For the **Name** attribute of the **Client** resource, specify the hostname of the NDMP host that contains the data to be backed up.

- b. For the **Storage Nodes** attribute of the **Client** resource, verify that the destination server for the data being backed up is listed first.

The client directs the data to the first storage node in the list that has an enabled device and is able to receive the data.

- c. Complete the rest of the required **Client** resource attributes and configure the NetWorker server in the same manner as for any other NDMP backup.

“Configuring the NetWorker server for NDMP operations” on page 529 provides instructions on configuring a NetWorker server.

Performing DAR backups

DAR is an optimized data recovery operation that allows data to be recovered in the middle of a tape set without the need to parse the tape set sequentially. This significantly reduces recovery time of large backups.

DAR is supported with SnapImage and the NetWorker DSA feature. Any data server that supports DAR is able to use this functionality when:

- ◆ `DIRECT=y` is set as an information variable
- ◆ DSA enabled storage node is used.

DSA acts as an agent in the performance of backups between a NetWorker server and any client without NetWorker software. An example of a DSA is an NDMP host that generates proprietary save data and sends that data to a NetWorker storage device to have a save set associated to it. Similarly, a DSA acts as an agent in the recovery between a NetWorker server and any client without NetWorker software.

When performing a DAR recovery from a tape device, the tape device needs to support variable length records, refer to the tape device vendor’s manual. If the tape device is not configured for variable length records, then DAR performance will degrade. This is true for any tape server as well.

The *EMC NetWorker Software Compatibility Guides* provides information on how to determine whether DAR is supported with a particular NDMP vendor.

To specify whether to use DAR, set the application information variables before the backup, specify these values:

```
DIRECT=y
HIST=y
```

DAR is supported in these NDMP configurations.

- ◆ Local
- ◆ Three-party

A DAR backup is performed in the same manner as a non-NDMP based backup. A DAR recovery is performed through the **recover** command, NetWorker User, or **nwrecover**.

Note: The `nsrndmp_recover` program cannot be used for a recovery with DAR.

Storage node support for NDMP client backup

In addition to being able to back up to an NDMP tape device, the **nsrndmp_save** program enables NDMP clients to back up to a NetWorker non-NDMP storage device (NetWorker storage node).

The *EMC NetWorker Command Reference Guide* or the UNIX man page provides more information on the **nsrndmp_save** command.

These sections describe how to perform an NDMP backup by using the **nsrndmp_save** command and the NetWorker **User** program. The *EMC NetWorker Command Reference Guide* or the UNIX man page provide information on the **nsrndmp_save** command.

The **nsrndmp_save** program starts the **nsrdsa_save** program (which is part of the NetWorker client software package) to back up data to a NetWorker storage device.

The **nsrndmp_save** program receives the file history, then processes and stores the indexes. The host on which the **nsrndmp_save** runs is the *index host*. The data to be backed up is generated by the NDMP data server. The host on which the **nsrdsa_save** program is running acts as a proxy to the NDMP host, which is the *proxy host*.

The **nsrndmp_save** program and **nsrdsa_save** program can be disassociated to run on different index and proxy hosts. This action helps improve performance and is highly scalable. For example, **nsrndmp_save** can be dedicated to run on a high-end host for processing millions of indexes, while **nsrdsa_save** can run on another host that has devices attached to it.

Data write technologies

The **nsrdsa_save** program, on execution, establishes a save session with the NetWorker server and listens on a port number. After a DSA receives data from the NDMP client, there are three different technologies that a DSA can use to write the data to a NetWorker storage device.

- ◆ Immediate save technology

The DSA reads the data by using TCP/IP into shared memory. The **nsrmmd** program writes the data to a storage device from shared memory. Virtually all the data from the NDMP client goes directly to **nsrmmd**.

- ◆ Direct file access (DFA) technology for a backup to disk

DFA directly writes the data directly to disk, bypassing the storage node (**nsrmmd** program). The storage node only plays a role in loading the volume. This is a highly efficient and high performance approach.

- ◆ Nonimmediate save technology (or remote save)

The DSA reads the data by using TCP/IP into a local buffer and transmits it to the **nsrmmd** program that is also using TCP/IP. The **nsrmmd** program writes it to the storage device. This approach is inefficient and has slow performance.

Rather than nonimmediate save technology, configure the setup so that the storage device is local to the **nsrndmp_save** program, and that an immediate save technology is supported. If an immediate save technology is not supported, such as when the attached storage device is remote, the DSA will fall back to a nonimmediate save technology.

Cloning and staging

After a backup is performed to a non-NDMP device, cloning and staging operations can be performed by using non-NDMP based NetWorker cloning and staging features and without involving the NDMP data or tape server. When NDMP save sets are marked as non-NDMP based NetWorker save sets and the volume data format is compatible with non-NDMP based NetWorker save sets, cloning and staging operations can be performed normally.

Multiplexing

Based on the server and device parallelism values, simultaneous multiple NDMP backup sessions can use a common non-NDMP device so that the device is kept busy. Similarly, multiple simultaneous NDMP recover sessions can read from a common volume if the data is multiplexed on that volume.

If the data is not multiplexed, then one NDMP save instance waits for the other to finish in the event that there are no available resources.

Multiple NDMP save instances can coexist with non-NDMP NetWorker save instances on the same volume. Any DSA save stream can join a non-NDMP NetWorker save stream. Both can be sent to the same volume.

Incremental backups and token-based backup support

In NetWorker 7.6 Service Pack 2 or higher, NDMP uses token-based backups (TBB) to perform NDMP full, incremental, and level 1-9 backups on NDMP servers that support TBB and that have been qualified with NetWorker. Currently, Celerra and NetApp servers with NDMP version 4 or higher support TBB and have been qualified. However, check with Celerra and NetApp for the maximum number of incremental levels supported with TBB incremental backups. NetWorker supports the same number of incremental levels that are supported by Celerra and NetApp.

A major benefit of TBB support is that true incremental backups can be performed on supported and qualified NDMP servers. On NDMP servers that do not support TBB or that have not been qualified with NetWorker, incremental backups are not supported. However, on these servers, you can use backup levels (1-9) to provide limited incremental backup support. [“Incremental backups on all other platforms” on page 544](#) provides more information.

IMPORTANT

Always check with your NAS storage vendor to verify that NDMP incremental backups are supported before using this feature.

Incremental backups with NetWorker 7.6 SP2 on Celerra or NetApp

If an incremental backup or a level 1 to 9 backup is configured, it will be performed after the first full backup (including incrementals that are forced to full) after the upgrade to NetWorker 7.6 SP2 or higher. Subsequent incremental or level 1 to 9 backups are performed as scheduled.

NDMP incremental backups can be scheduled and run from:

- ◆ A scheduled backup group, like any other NetWorker client.
- ◆ The NetWorker User program.
- ◆ The command prompt with the `nsrndmp_save` command.

If you are running an incremental backup from the command prompt, specify a date and time with the **-t** option along with the **-l** option. The **-t** option is the date and time of the last backup. You can get the date and time of the last backup from the output of the **nsrndmp_save** command that was run for the last backup. To find the date and time, look for a line similar to the following:

```
42920:nsrndmp_save: browsable savetime=1296694621
```

Where the value after *savetime=* is a date and time that can be used with the **-t** option when the next incremental or level 1-9 backup is run from the command prompt.

You can also find the date and time of the last backup by using the **mminfo** command, for example:

```
mminfo -v -c nw_client
```

Where **-v** enables the display of verbose reports and **-c nw_client** specifies the NetWorker client for which the date and time is being sought. The following is an example of partial output from the **mminfo -v -c** command:

volume	type	client	date	time	size	ssid	fl	lvl	name
vol.001	adv_file	nwclient1	02/16/11	15:23:58	1853 MB	3864812701	cbNs	full	/.../set1
vol.001	adv_file	nwclient1	02/16/11	15:39:58	815 MB	3848036430	cbNs	incr	/.../set1
vol.001	adv_file	nwclient1	02/11/11	09:24:23	460 MB	3897913543	cbNs	full	/.../set2

You can specify the date and time with **nsrndmp_save -t** using the bolded values as in **-t "02/16/11 15:23:58"**. The double quotes are required when using date and time information from the **mminfo** command.

If the **-t** option is not specified when **nsrndmp_save** is used from the command line, then the NDMP server's native level-based backup will be used as described in [“Incremental backups on all other platforms” on page 544](#).

If the backup is run as part of a NetWorker scheduled backup group, date and time information is supplied automatically and incremental and level backups work as expected.

By default, support for incremental backups is provided after upgrading to NetWorker 7.6 SP2 and if you are using a Celerra or NetApp storage platform. If necessary, you can disable TBB support and therefore, support for incremental backups, and revert to the NDMP server's native level-based backup support by placing the variable **USE_TBB_IF_AVAILABLE=n** in the NetWorker NDMP client resource **Application Information** attribute. However, disable this attribute only in consultation with NetWorker Technical Support.

Incremental backups on all other platforms

Prior to NetWorker release 7.6 Service Pack 2, or on storage platforms other than Celerra and NetApp, the NetWorker software does not support incremental backups for NDMP backups. If you select the incremental setting, the NetWorker server performs a full backup. However, you can schedule level backups to function like incremental backups. For example, a weekly backup schedule of full on day 1 and incrementals on days 2 through 7 can be accomplished by setting up a weekly backup schedule of full on day 1, level 1 on day 2, level 2 on day 3, level 3 on day 4, and so on.

Force incremental and interval attributes for NDMP tape server

Note: This section does not apply to NDMP backups on the Celerra or NetApp storage platforms when NetWorker 7.6 Service Pack 2 or higher is in use. Incremental backups are supported on these platforms.

If the Force Incremental attribute is set to Yes, and the Interval attribute is set to a value less than 24 hours, execution of a level 1 to 9 backup from the Console, NetWorker User program, or **save** program results in a full backup.

Performing NDMP recoveries

NDMP save set and directory-level recoveries are performed with NetWorker User (Windows), **nwrecover** (UNIX), or the **nsrndmp_recover** command. NDMP file-by-file recoveries are performed through **nwrecover** or the **recover** command.

The **nsrndmp_recover** command supports most of the same command line operations as **recover(1m)**, in addition to others that specifically support NDMP. When data is retrieved with **nwrecover** (UNIX) or NetWorker User (Windows), the **nsrndmp_recover** command is selected automatically.

Note: NDMP does not support the recover options **Rename Recovered File** and **Discard Recovered File**. For both save set and file-by-file recoveries, *current files are always overwritten*.

Storage node support for NDMP client recovery

The **nsrndmp_recover** program recovers data from a NetWorker storage device when **nsrdsa_recover** is started on the same host. The **nsrndmp_recover** program is spawned by the following programs:

- ◆ **recover**
- ◆ **nwrecover**
- ◆ **winworkr** (NetWorker User graphical interface)
- ◆ **command line**

The **nsrndmp_recover** program sends data to the NDMP data server. The **nsrndmp_recover** and **nsrdsa_recover** programs cannot disassociate themselves as with the backup programs, **nsrndmp_save** and **nsrdsa_save**. The **nsrndmp_recover** program identifies that the save set is stored on a non-NDMP device and invokes the **nsrdsa_recover** program to perform a recovery from the non-NDMP device. There are no changes to the command line options for **nsrndmp_recover** when using storage node support for NDMP client recovery.

Note: Data written to a storage device by the **nsrdsa_save** program can be recovered only by using the **nsrdsa_recover** program. A tape that has NDMP data backed up with the **nsrdsa_save** program cannot be used by any other recovery tool.

Optimizing recoveries

When a backup is performed with the **-P**, **-I**, or **-M** option, and the intention is to optimize recovery time, launch a recovery on a host that has locally attached NetWorker devices. If a recovery is launched on a host other than the device host, then the recovery performance will degrade as data flows from the device host to the recovery host, and then from the recovery host to the NDMP data server.

Performing a save set recovery

These sections describe how to perform a save set recovery from the NetWorker User or `nwrecover` programs, or from the command prompt. For , see [“Performing a directed recovery” on page 549](#) provides more information about directed recoveries.

How to perform a save set recovery with the NetWorker User program

To perform a save set recovery from the User program:

1. From the **Operation** menu, select **Save Set Recover**.
2. Select the **NDMP** client with the save set data to be recovered and click **OK**. The save sets available for recovery appear in the **Save Set** dialog box.
3. From the **Save Set Name** list box, select the specific save set with the data to be recovered. After a save set is selected, that save set’s backup instances appear in the **Version** window.
4. Select the particular instance of the save set’s backup to recover.
5. If needed, specify a subdirectory in the **Path to Recover** attribute, and click **Start**.

Note: The **Save Set Recover** window contains a **Recover Options** window for NDMP recoveries. This window is used if you are recovering the data to a path other than the save path. [“How to perform a directed save set recovery” on page 550](#) provides instructions on using this window.

How to perform a save set recovery with the NetWorker Recover program

To recover save sets by using `nwrecover`:

1. In `nwrecover` program, select **Save Set Recover** from the **Options** menu.
2. In the **Save Set** window, click the save set to be recovered.

You can select an unlimited number of versions for the same save set for simultaneous recovery.

- If you do not choose a save set from the list, the NetWorker server automatically selects the last save set on the list.
 - If you do not choose a save set instance to recover, the NetWorker server automatically selects a save set instance.
3. When all the files to recover are selected, click **Recover**.

Perform a save set recovery from the command prompt

To perform a save set recovery from the command prompt, type:

```
nsrndmp_recover -c client -s server -S ssid/cloneid
```

For example, to recover data to the original location client named *venus*, with a server named *mars*, from the command prompt, type:

```
nsrndmp_recover -c venus -s mars -S 2485094913
```

Destructive save set recoveries

When NDMP data is backed up using the SnapImage Module, save set recoveries are generally destructive. With a destructive save set recovery, data can be recovered to the original location or an alternate location, and in either case all existing data is overwritten. Essentially, destructive save set recoveries overlay the data at File system level and re-impose the saved image of the File system.

Destructive save set recoveries are performed using the `nsrndmp_recover` command with the `-r raw_device` and `-m mountpoint` options. When `-r raw_device` is specified, `-m mountpoint` is mandatory (however, when `-m mountpoint` is specified, `-r raw_device` is not required). For example, on a Microsoft Windows system, the following command would perform a destructive save set recovery to the P:\ drive:

```
nsrndmp_recover -s mars -c venus -m P:\ -r P:\ -S 2674606849
```

On a UNIX system, the following command would perform a destructive save set recovery to the `/dev/dsk/c1t1d0s0` device, mounted at `/`:

```
nsrndmp_recover -s mars -c venus -r /dev/dsk/c1t1d0s0 -S 2674606849 -m /
```

Note: Excluding the `-r` option from the above commands, and then identifying the pathname of the file to be restored, will make the SnapImage save set recoveries non-destructive and operate at the file/directory level rather than the filesystem level. This will still overwrite existing files on the destination that have the same names as those in the restore list, but will leave other data untouched on the file system. This may be useful when doing a directory level recovery in a high density filesystem environment to restore everything under one directory when it is not practical to pass all the file names that use the NetWorker User or `nwrecover` graphical interface.

The *EMC NetWorker Command Reference Guide* or the UNIX man page provide information on the `nsrndmp_recover` command.

Performing a directory-level recovery

These sections describe how to perform a directory-level recovery from NetWorker User or from the command prompt. [“Performing a directed recovery” on page 549](#) provides information about directed recoveries.

How to perform a directory-level recovery from the NetWorker User program

To perform a directory-level recovery from the User program:

1. From the **Operation** menu, select **Save Set Recover**.
2. Select the NDMP client from the **Source Client** window with the save set data to be recovered and click **OK**. The save sets available for recovery appear in the **Save Set** dialog box.
3. In the **Save Set Name** list box, select the save set with the data to recover. The save set's backup instances appear in the **Version** window.
4. Select the particular instance of the save set's backup to recover.
5. Click **Start**.

Note: The **Save Set Recover** window contains a **Recover Options** window for NDMP recoveries. This window is used to recover data to a path other than the save path. [“How to perform a directed save set recovery” on page 550](#) provides instructions on using this window.

How to perform a directory-level recovery from the command prompt

To perform a directory-level recovery:

- ◆ From a UNIX command prompt, type:

```
nsrndmp_recover -c client -s server -S ssid -v verify_flag paths
```

- ◆ From a Microsoft Windows command prompt, type this command:

```
nsrndmp_recover -s server -c client -R recover_target {-r rawdev -S  
ssid -m mntpnt|-F} -v verify_flag paths
```

The *EMC NetWorker Command Reference Guide* or the UNIX man page provides information on the **nsrndmp_recover** command.

Performing a file-by-file recovery

A file-by-file recovery only recovers a select group of files or directories. These sections describe how to perform a file-by-file recovery.

How to perform a file-by-file recovery from the recover program

To recover files by using **nwrecover**:

1. To open the NetWorker Recover window, type the following at the command prompt:

```
nwrecover
```

You can select a file that is listed in the NetWorker Recover window for recovery. To perform a recovery:

- a. Browse the index for a backups.
- b. Select various versions of the file to recover.
- c. View your marked files.
- d. Relocate files upon recovery (optional).
- e. Recover files from another authorized system (optional).

An authorized system is a client from which you have permission to recover data.

2. If necessary, select a server by clicking **Change Server** on the speedbar.
3. If necessary, change the level of displayed file information.
 - To expand the directory display one level, double-click the directory folder in the directory display.
 - To expand a directory branch to display subdirectories, click a directory folder and select **Expand Branch** from the **tree** menu.
 - To collapse a branch, double-click the directory folder in the display.
 - To view detailed information for files in a directory, select **File Details** from the **View** menu.
4. Select the files (or directories) to be recovered, and click **Mark**.
5. From the **View** menu, select **Volumes** to see whether the volumes are online for the recovery.
6. Click **Start** to begin the recovery.
7. In the **Conflict Resolution** dialog box, click **OK**.

8. When the recover completion time message in the **Recover Status** window appears, click **Cancel** to close the window.

How to perform a file-by-file recovery with the NetWorker User program

To perform a file-by-file recovery with the User program:

1. Click **Recover** to open the **Source Client** dialog box.
2. Select the source client with the data to recover, and click **OK**.
The local client is the default selection.
3. In the left pane of the **Recover** window, select the save set that contains the required files.
4. In the right pane, select the file or files to recover.
5. Click **Mark** to select these files for recovery.
6. To recover the files to another path on the same host:
 - a. From the **Options** menu, select **Recover Options**.
 - b. In the **Relocate Recovered Data To** text box, specify the path.
 - c. Click **OK**.
7. Click **Start**.

How to perform a file-by-file recovery from the command prompt

To perform a file-by-file recovery:

1. From the command prompt, type:

```
recover -s server
```
2. When prompted, type the directory to browse, for example:

```
cd \.
```
3. Issue the appropriate commands to add the necessary files to the recover list. The *EMC NetWorker Command Reference Guide* provide a complete list of command options.
4. When all the required files have been added, type:

```
recover
```

On a Microsoft Windows a Windows system program named **recover.exe** is also located in `%SystemRoot%\System32`. To avoid using the Windows version of **recover.exe**, do one of the following:

- ◆ Include the full path at the command prompt.
- ◆ Ensure that `<NetWorker_install_path>\bin` is listed before `%SystemRoot%\System32` in the PATH environment variable.

Performing a directed recovery

NetWorker software with NDMP supports directed recoveries that enable you to recover backup data to a host or path other than the one used to back up the original data.

Note: The operating system of the target host (*hostname*) must be the same as the one used to back up the data, and the target host must be a client of the NetWorker server. If it is not a client, the server cannot obtain the correct username and password, and the data cannot be recovered to that host. For example, if the original data was backed up to a NetApp filer, the data must be recovered to the same NetApp filer or another NetApp filer that is a NetWorker client.

Note: To perform a directed recovery with an Auspex filer, Auspex requires that you specify an existing directory as the destination directory. If the directory does not already exist, the recovery will not complete.

How to perform a directed save set recovery

You can perform a directed save set recovery by using the NetWorker **User** program or the **nsrndmp_recover** command.

- ◆ When using NetWorker User:
 1. From the **Operation** menu, select **Save Set Recover**.
 2. In the **Source Client** window, select the source client.
 3. In the **Save Sets** dialog box, select the backup version to recover.
 4. Click **Recover Options**. The **NDMP Recover Options** window appears.
 5. In the **Destination Client** text box, specify the client to receive the recovered data.
 6. In the **Relocate Recovered Data To This Path** text box, specify the recovery path for the volume. If recovering to a Windows platform, this attribute should contain the same drive letter as the **Raw Device** attribute.

Note: If you are recovering to a filer or UNIX platform, specify *target_hostname::/mount_point*.

7. In the **Relocate Recovered Data To This Raw Device** text box, specify the drive letter of the destination drive. If you do not specify the raw device name of the destination, the save set is recovered and the files are overwritten, but the current file system structure is retained.
8. Click **OK**.
9. In the **Save Set** window, click **OK**.

- ◆ When using **nsrndmp_recover**, type:

```
nsrndmp_recover -c client -m target_hostname::/mount_point -S ssid
```

For the mount point, specify the NAS computer hostname. If you are using Data ONTAP, you might need to add a slash (/) after the mount point. For example, *target_hostname::/mount_point/*.

Note: In these command sequences, the host specified is the target host to which the data is recovered. If a host is not specified, the data is recovered to the original application server. The *mount_point* variable remains the previously defined mount point of the application server.

The *EMC NetWorker Command Reference Guide* or the UNIX man page provide more information on the **nsrndmp_recover** command.

How to perform a directed file-by-file recovery

You can perform a directed file-by-file (Windows) recovery by using either the NetWorker User program or the **recover** command.

- ◆ When using the NetWorker **User** program:
 1. Click **Recover** to open the **Source Client** dialog box.
 2. Select the source client with the data to be recovered, and click **OK**.
 3. Select the source client with the data to recover, and click **OK**.
 4. In the left pane of the **Recover** window, select the save set that contains the files to recover.
 5. In the right pane, select the files to recover.
 6. Click **Mark**, then **Start**.
- ◆ When using the interactive **recover** program:
 1. From the command prompt, type:

```
recover -s server
```
 2. When prompted, type the directory to browse, for example:

```
cd \.
```
 3. Run the appropriate commands to add the necessary files to the recover list. The *EMC NetWorker Command Reference Guide* or the UNIX man page provide a complete list of command options.
 4. To recover the files to a different location, type:

```
relocate target_hostname::\mount_point
```

Note: In these command sequences, the host specified is the target host. If a host is not specified, the target is the original application server. For the mount point, specify the NAS computer hostname. If you are using Data ONTAP, you might need to add a backslash (\) after the mount point. Here is an example, *target_hostname::\mount_point*.

5. When all the required files have been added, type this command:

```
recover
```

The files are recovered to the specified location.

How to perform a directed index recovery

You can perform a directed index (UNIX) recovery using the **recover** program.

1. From the command prompt, type:

```
recover -s server
```
2. When prompted, type the directory to browse, for example:

```
cd /.
```
3. Run the appropriate commands to add the necessary files to the recover list. The *EMC NetWorker Command Reference Guide* or the UNIX man page provide a complete list of command options.
4. To recover the files to a different location, type this command:

```
relocate target_hostname::/mount_point
```

Note: In these command sequences, the host specified is the target host. If a host is not specified, the target is the original application server. For the mount point, specify the NAS computer hostname. If you are using Data ONTAP, you might need to add a slash (/) after the mount point, for example, *target_hostname::/mount_point/*.

5. When all the required files have been added, type:

```
recover
```

The files are recovered to the specified location.

Snapmirror to tape backup and recovery

NetApp's Snapmirror to tape (SMTape) feature allows block-level backup of SnapMirror volumes. Large NetApp file systems can be backed up using the SMTape feature integrated with the filer. SMTape is faster than the traditional network data management protocol (NDMP) due to the block-level copy of data during backup. In cases where millions of files reside on the NetApp filer, using SMTape can significantly reduce the backup window, and can be used in instances where NDMP full backups become impractical.

NetWorker 7.6 SP3 provides the ability to back up NetApp filers using SMTape for backup and recovery. Use of the NDMP SMTape feature provides an additional level of disaster recovery by copying the large NetApp file systems to secondary storage, since most of the NetApp file systems use the standard NDMP full or differential backups.

The NetApp documentation provides more information on how to use this feature, and can be accessed at the following link:

<http://now.netapp.com/>

Limitations and Guidelines

File systems can be backed up using SMTape by setting option commands on the NetWorker server. However, the following limitations apply when using snapmirror images backup.

- ◆ SMTape allows for backup and recovery of full volumes only and cannot be used for file indexes or file restores. NetWorker therefore does not support incremental or differential backups and file/directory level recovery of SMTape backups.
- ◆ The recovery can only be performed with the save set ID.
- ◆ The file server generates a snapshot of the file system at the beginning of the SMTape operation. The conditional call to retain or delete the snapshot is controlled by the environment variable provided by NetApp.
- ◆ Once the Snapmirror image is retrieved to the NetApp file system, the target file system remains as Snapmirror partner. The conditional call to break or retain the snapshot in the original state is controlled by the environment variable used during the recovery. In the absence of the variable, the Snapmirror continues to retain the same state at the time of backup.

SMTAPE Configuration

The following configuration parameters must be changed to use SMTAPE:

- ◆ Configure the NetApp Filer in NetWorker.
- ◆ Configure the NDMP / NON-NDMP devices for backup.
- ◆ Backups can be taken to mirrored to disk as well as tape
- ◆ NetWorker supports 240 kb block size for smtape backups. You can check for other supported block size by running `-A <NDMP_TAPE_BLOCK_SIZE>`.

Commands and descriptions

The following SMTAPE backup and recovery commands can be run:

- ◆ **nsrndmp_save -T smtape -c filerhost /vol/vol1**
This command will back up the volume `/vol/vol1` and mirror the backup to the NDMP tape. The default block size of 240kb is used.
- ◆ **nsrndmp-save -M -T smtape -c filerhost /vol/vol1**
Using the `-M` option in the command ensures that the volume gets mirrored to the disk/tape once the backup is complete.
- ◆ **nsrndmp_save -T smtape -A NDMP_TAPE_BLOCK_SIZE=245760 -c filerhost /vol/vol1**
This command performs a backup of the volume `/vol/vol1` using a customized tape block size that is triggered by using the `-A` option during the backup.
- ◆ **nsrndmp_recover -c filerhost -S xxxx -m /destination**
This command recovers the data from the mirror created on the tape using the SSID, The mirror in this case would reside on the filer.
- ◆ **nsrndmp_recover -c filerhost -S xxxx -R 3rdpartyfilerhost -m /destination**
This command recovers the data from the mirror to a different filer using the SSID.
- ◆ **SMTAPE_BREAK_MIRROR = Y**
During the recovery of the mirror, setting the variable **SMTAPE_BREAK_MIRROR=Y** in the NetWorker client properties ensures that the mirror is broken and the volume becomes available for reuse. In the event that the variable is not set or **SMTAPE_BREAK_MIRROR=N** is run, the mirror would remain in the state as it was backed up.

Note: The environment variable can be used for both NDMP and non-NDMP (DSA) backups.

- ◆ **SMTAPE_DELETE_SNAPSHOT = Y**
When backing up the filer volumes, setting the variable **SMTAPE_DELETE_SNAPSHOT = Y** in the NetWorker client properties ensures that the mirror that is created during the backup is deleted at the end of backup. In the event of the absence of the variable, a new snap mirror image would be created for every attempted backup.

NDMP cloning

NDMP cloning is set through the same NetWorker clone interface as non-NDMP based backups. [Chapter 9, “Cloning”](#) provides information on how to clone data.

Note: To support cloning, the source NDMP host must be running NDMP version 3 or later. The destination server can be running any version of NDMP, but a volume cloned with NDMP earlier than version 3 cannot be cloned again to another volume.

Cloning between storage nodes

Cloning between storage nodes is accomplished by an NDMP tape server on the source node by reading from a volume, and another NDMP tape server on the target node by writing to a volume. However, cloning from a NDMP tape device to a non-NDMP tape device, and vice-versa, is not supported.

If the save set to be cloned was backed up by `nsrndmp_save` by using `nsrdsa_save` (that is, the DSA feature save set flags are used to differentiate the save set records, which include *N* and *s*), then use `nsrclone`, and not `nsrndmp_clone`, to clone these save sets. The `nsrdsa_save` generated save sets can be cloned to any NetWorker storage device other than an NDMP tape device.

The source node is determined by the location of a source volume. The location of the source volume is determined either by its currently mounted location or, if unmounted, by its location field (see the `mmlocate` man page). The target node of a clone is found by the Clone Storage Nodes attribute of the Client resource in descending priority.

Cloning functionality

The following functionality applies to NDMP cloning.

- ◆ The NetWorker Console and the command line interface support volume cloning, save set cloning, and the cloning of all save sets as part of a scheduled group.
- ◆ NDMP tapes from one NDMP host can be cloned to another NDMP host of the same type. For example, tapes from a NetApp filer that has a library attached can be cloned to another NetApp filer or to the same filer.
- ◆ NDMP cloning can copy data from one type of tape device to another, for example data from DLT to AIT.
- ◆ Once the cloning is complete, the NetWorker server verifies that the cloned copy was successfully created. In the Volumes window that contains the save set information, the cloned save set is marked cloned.
- ◆ A cloned volume or save set can be automatically or recovered manually. [“Volume cloning” on page 227](#) and [“Recovering cloned data” on page 227](#) provide more information.

NDMP index and bootstrap cloning

Index and bootstrap cloning is performed only through a non-NDMP-based cloning device. Index and bootstrap cloning can be achieved either through the command prompt by using `nsrclone` or by using the NetWorker Console through a scheduled group with automatic cloning.

[“Setting up a schedule clone job” on page 220](#) provides more information on automatic cloning.

A full device setup for NDMP cloning involves four devices when automatic cloning is enabled.

- ◆ An NDMP tape device that is used for NDMP backups and is the source device for NDMP cloning.
- ◆ An NDMP cloning device that is used to clone an NDMP save set or volume.
- ◆ A non-NDMP device that is used for backing up bootstrap information and indexes.
- ◆ A non-NDMP cloning device that is used for cloning indexes and bootstrap from an NDMP backup.

Note: The indexes and bootstrap are non-NDMP save sets, so a non-NDMP device is needed to clone those non-NDMP save sets. The indexes and bootstrap both go to the same volume, unless they are configured to go to separate devices.

When cloning is performed manually, a minimum of two devices are required, one to read the existing data and one to write the cloned data. [“Cloning a save set manually” on page 223](#) provides more information.

NDMP Path-to-Tape cloning for regular save sets

NetWorker 7.5 and higher supports NDMP path-to-tape cloning of regular save sets with the `nsrndmp_clone` command.

Using NDMP cloning, regular NetWorker save sets from a DL3D 1500 or 3000 Virtual Tape Library (VTL) running version 1.1.2, can be copied directly to a physical tape library, which is attached to the VTL. This process, also known as path-to-tape, frees up network bandwidth and offloads NetWorker storage node I/O resources because save set data does not go through the storage nodes. NetWorker manages the data movement and catalogs the physical tape copy in the media database as a clone instance. Both the VTL and the physical tape devices are visible to the NetWorker storage node and restores can be performed directly from either copy.

IMPORTANT

This feature is available with EMC DL3D models 1500 and 3000 at version 1.1.2, Version 1.1.2 is available on request from your EMC DL3D account representative.

The path-to-tape feature can also be set up to move data from one physical tape library to another physical tape library. Additionally, all NDMP clone options work with the path-to-tape feature.

Requirements and limitations for NDMP cloning regular save sets

Ensure that the following are configured before starting the NDMP cloning process:

- ◆ An NDMP storage node resource is required for the VTL. The VTL must have drives configured for NDMP.
- ◆ An NDMP storage node resource is required for the physical tape library. The physical tape library must have drives configured for NDMP.
- ◆ A client resource must be defined for the storage node. For example, if a disk library/EDL is used as an NDMP storage node, create a client resource for that storage node.

- ◆ The Client resource that corresponds to the source save sets or volumes must have its **Clone Storage Node** attribute set to the destination storage node host, which is where the clone data is to be written. The destination storage node is usually the hostname of the NDMP storage node for the physical tape library.
- ◆ Do not use the "device tape flags" variable (if you are in Diagnostic Mode) to restrict the volume size when performing NDMP (including path-to-tape) cloning.

Path-to-Tape cloning for tapes with different block sizes

From release 7.6 onwards, NetWorker supports path-to-tape cloning between tapes of different block sizes.

Note that, however, NetWorker does not support cloning of a path-to-tape clone instance that is cloned from a tape of a different device file size than that of the original source tape.

For example, consider the case in which you create a back up save set (referred to as clone instance #1 by default) on an LTO-3 tape that has a block size of 128KB and a device file size of 4GB. Using path-to-tape, you then create a clone save set (clone instance #2) to another LTO-1 tape that has a block size of 64KB and a device file size of 1GB. If you use path-to-tape to clone "clone instance #2" to another LTO-1 tape, the cloning attempt will fail with the following error messages:

```
nsrndmp_clone: Error - Incorrect tape file size
<current_tape_file_size>
nsrndmp_clone: Set device file size to <recommended_value> in source
device properties
You will have to change the source device file to the value suggested
by the nsrndmp_clone error messages.
```

In this scenario, you could perform one of the following options, however, it is recommended that you perform option 2:

- ◆ Option 1
Change the source (clone instance #2) device file size to the value suggested in the error message and restart the clone operation.

IMPORTANT

After the cloning operation, change the source device file size back to its original value; otherwise, subsequent cloning attempts using this source device would create clone instances that may not be recoverable.

- ◆ Option 2
Perform the second clone operation from the original source, which is clone instance #1 in this example.

Using the nsrndmp_clone command for cloning regular save sets

For NDMP cloning of regular save sets, use the following command:

```
nsrndmp_clone -J ndmp_storage_node -p -b clone_pool -s ssid1 ssid2...
```

where:

- ◆ The **-J** option is used to specify the ndmp clone to load the source device on a specified host.
- ◆ The **-p** option is used to create a clone of regular save sets.
- ◆ The **-b** option is used to specify the pool type.
- ◆ The **-S** option is used to identify the save set ID(s).

Note: NDMP supports cloning of opaque save sets with same block or device file sizes from the original size.

Recover can be done from the original backup or from the clone copy. You can perform a regular file-by-file or save set recover. A regular storage node resource is required both for the VTL and the physical library. The VTL and the physical tape library must have drives configured for SCSI. The recover process will automatically load the volume from an NDMP drive to a non-NDMP drive (SCSI path).

Note: The recovery process automatically selects a SCSI path for recovery. It will not select the NDMP path because the save sets to be recovered are non-NDMP save sets.

Ancillary product information

These sections cover limitations and configuration requirements for specific vendors and other NetWorker modules:

- ◆ [“Filers that act as data servers” on page 557](#)
- ◆ [“Filers that act as tape servers only” on page 569](#)

Filers that act as data servers

This section contains configuration information for these vendor products that act as NDMP data servers:

- ◆ [“Network Appliance” on page 558](#)
- ◆ [“EMC Celerra” on page 562](#)
- ◆ [“EMC Centera” on page 564](#)
- ◆ [“EMC IP4700” on page 564](#)
- ◆ [“Auspex” on page 565](#)
- ◆ [“Procom NetFORCE” on page 567](#)
- ◆ [“Mirapoint” on page 568](#)
- ◆ [“BlueArc” on page 568](#)

Backup on NDMP servers is dependent on the data server provider type. Servers use the commands listed in [Table 99 on page 557](#).

Table 99 NDMP server examples

Server	Command	Function
EMC	dump	Used for backing up filer data to tape. Also used to back up directories, quota trees, or entire volumes.
NetApp	dump	Used for backing up filer data to tape. Also used to back up directories, quota trees, or entire volumes.
Auspex	gtar	Used for archiving the contents of a directory to a file or tape.
EMC SnapImage Module	SIDF or dd	SIDF (System Independent Data Format) backups allow users to interchange media with operating system backup utilities and other tape backup products from vendors that comply with the SIDF standard. A dd-compatible command backs up all blocks in the file system. Data is written in dd image.

Only those variables listed in the sections corresponding to a given NAS filer are supported by the NetWorker software. Variables documented in NAS filer reference guides do not necessarily work for NetWorker backups. In these cases, the results may be unpredictable.

For example, the variable FILESYSTEM is supported by NetApp. With NetWorker 7.2.x, this value is passed to NetApp, which translates the path as required. This is the path that is backed up, not the one specified by the save set.

Network Appliance

The following sections provide information about limitations, autochanger configuration, and application information variables for the NetApp filer. For a complete list of supported Data ONTAP versions, refer to the *EMC NetWorker Software Compatibility Guide*.

Features and limitations

These sections cover NDMP issues that are specific to NetApp hosts.

Note: NetApp passwords are limited to eight characters.

Backup and recovery of large number of files

On Network Appliance clients with an operating system of Data OnTap 6.4 and later, all metadata is read from tape before the files are recovered. As such, with large save sets (save sets with 20 million files or more), the recovery time for a file can exceed three hours. This also applies for backup, as the metadata for the whole volume is recorded onto tape even for a single file backup.

UTF-8 versions supported

The NetWorker software supports the UTF-8 format with CIFS clients. NFS clients of a NetApp filer are only supported if the NFS clients can generate UTF-8 encoded data. Support for UTF-8 is specified in the Application Information attribute of the Client resource.

UTF8=n is the default setting and should remain set. It is no longer required to set the **UTF8=y** variable in the Application Information attribute during a NetWorker client configuration for NDMP clients. If the **UTF8=Y** variable is set during an NDMP client backup and the backup contains pathnames with non-ascii characters, an index based recovery of this backup will fail with the error "RESTORE: could not create path <pathname>".

If upgrading from any NetWorker release previous to 7.3 Service Pack 3, remove the **UTF8=y** variable from the client configuration in order to ensure successful backup and recovery operations:

1. Connect to the NetWorker server using the NetWorker Management Console (NMC).
2. Click on the **Configuration** button.
3. Click on **Clients**.
4. In the clients window, right-click on the NDMP client and select **Properties**.
5. Click the **Apps and Modules** tab.
6. In the Application Information section, remove **UTF8=Y** if defined.
7. Click **OK**.

For existing backups that were run with **UTF8=y** in NetWorker 7.3 Service Pack 3 or later, pathnames with non-ascii characters must be recovered using either a save set recovery from the command line, or NDMP Directory restore.

Note: Ensure that the NAS filer is configured for UTF8 characters sets. Contact your NAS vendor for configuration requirements.”

Single save sets support only one code set

A single save set supports data that belong to only one code set. If you have data in multiple code sets, you must create multiple save groups.

The save set can contain filenames that belong to different languages if all characters in those languages belong to the same code set. For example ISO 8859-1 and ISO 8859-15 include most Western European languages, such as French, Spanish, and Portuguese, so filenames from these languages can be backed up in a single save set.

Required NDMP version when running DAR on a NetApp host

To run DAR on a NetApp host, you must have NDMP version 3 or later. Recoveries fail if an earlier NDMP version is used.

How to verify the NDMP version

To verify the NDMP version:

1. Log in to the NetApp host as root or as a Windows Administrator.
2. Type this command:

```
ndmpd version
```

The NDMP version is displayed.

How to change the NDMP version

To change the NDMP version:

1. Log in as root or as Windows Administrator.
2. Stop the NDMP process by typing:

```
ndmpd off
```

The NetApp host confirms that the NDMP process has stopped.

3. To change the NDMP version, type:

```
ndmpd version 4
```

The NetApp host confirms that the NDMP version is now set to 4.

Note: The NDMP version can also be set to 3.

4. To restart the NDMP process, type:

```
ndmpd on
```

The NetApp host confirms that the NDMP process has started, and DAR can now be run.

NetApp zoning requirements for DDS in a SAN environment

In order to configure DDS with NetApp filers, a zoned SAN configuration is required. Zoning is a feature of the Fibre Channel switch.

The NetApp zone, which contains only the NetApp filers and tape devices, must be configured on the Fibre Channel switch. This NetApp zone may also include the robotic arm and must also be configured in an arbitrated loop.

All non-NetApp servers that are attached to the same Fibre Channel switch must be excluded from the NetApp zone. A separate zone must be configured for the non-NetApp servers, in which an arbitrated loop may or may not be a requirement.

The NetApp zone and all other zones can overlap on the tape devices within the SAN, so that the tape devices are visible to both zones.

How to find the device pathname for a NetApp host

The pathname of the media device is required before the autochanger for NDMP backups and recoveries can be configured. Use the pathname to configure the autochanger with the `jbconfig` program, as described in [“Configuring library support for NDMP” on page 530](#).

Note: This procedure is only an example. For the correct syntax and usage, refer to the NetApp documentation.

To identify the media device pathname:

1. Log in as root or as Windows Administrator
2. Verify that the tape device is installed on the NetApp filer by typing this command.

```
sysconfig -v
```

The host responds with:

```
NetApp Release 6.2: Sun Mar 12 13:29:37 PST 2009
System ID: 0016784666 (NetAppHost1)
slot 6: SCSI Host Adapter 6 (Qlogic ISP 1040B)
Fast/Wide, Differential
Firmware Version 4.65 Clock Rate 60MHz.
4: QUANTUM Powerstor L200 001F
5: QUANTUM DLT7000 2255
```

3. Determine the device pathname by typing this command.

```
sysconfig -t
```

The host responds with a list of media device names.

```
Tape drive (6.5) Digital DLT7000
nrst0a - no rewind device, format is: 85937 bpi 70 GB (w/comp)
nrst0m - no rewind device, format is: 85937 bpi 35 GB
```

where:

- **(6.5)** indicates slot 6 and SCSI ID 5. This information must match the output in the `sysconfig -v` command.
- **nrst0a** is the media device name.

If the NDMP tape server is running version 2 or does not support NDMP_CONFIG interfaces, determine the autochanger handle by typing this command.

```
sysconfig -m
```

The host responds with the devices on the host.

```
Media changer (6.4)  QUANTUM  Powerstor L200 mc0 - media changer
device
```

where **mc0** is the autochanger handle.

Note: When **jbconfig** prompts for the hostname and device path for a NetApp device, do *not* type a slash before the device name. Although the **jbconfig** program completes without errors if the slash is typed, NetApp will not recognize the tape device or autochanger, and you will be unable to label the tape.

Application information variables

In addition to the standard application information variables, HIST=y and UPDATE=y, that are required for all vendors, [Table 100](#) lists variables specific to NetApp that may be required. Type these variables in the Application Information attribute of the Client resource, as described in [“Configuring an NDMP Client resource” on page 535](#).

Table 100 NetApp application information variables

Variable	Required	Values and meaning
FILESYSYTEM= <i>path</i>	No	This variable, if passed to NetApp, will supersede the save set specification.
DIRECT= y/n	Yes for DAR operations	This value must be set to y if you are performing a DAR recovery. If you are not performing a DAR recovery, the value is set to n . DAR is supported on Data ONTAP 6.1 and later. “Performing DAR backups” on page 541 provides additional information about DAR.
EXCLUDE=	No	This string value determines which files are excluded from backup. These rules apply. <ul style="list-style-type: none"> The string is a filename. Only filenames are accepted, not absolute paths. The asterisk (*) is accepted as a wildcard, but it must be the first or last character in the string (or both). To list multiple files, separate each name with a comma. A comma cannot appear as part of the filename. Spaces are not allowed. You can specify up to 32 strings.
EXTRACT_ACL= y	Yes to recover ACLs	To recover access control lists (ACLs) when using DAR with a NetApp host, you must set the value to y . The default is n .
UTF8=n	For UTF-8 formatted data	The default is n and should remain set

EMC Celerra

These sections provide information about limitations, autochanger configuration, and application information variables for the Celerra host. The *EMC Software Compatibility Guide* provides a complete list of supported versions.

Celerra considerations with NDMP

These sections discuss NDMP issues that are specific to Celerra filers.

Celerra backup of root file system

Instead of specifying a save set of All for an Celerra backup operation, the separate file systems should be named in the save set definition, excluding the root, or “/” file system. Including the root file system causes the client index to fail.

Using an earlier version of NDMP on Celerra Data Movers

Celerra data movers are run in the default configuration, which enables support for the latest version of NDMP. Servers autonegotiate with other NDMP devices so that the NDMP versions are compatible. At times, the autonegotiation function fails. In this case, Celerra can be forced to use an earlier version of NDMP to test whether the devices can still function. This can also help to isolate NDMP issues by determining if the problem happens with different versions.

Lower the NDMP version on Celerra

The NDMP version must be set individually on each data mover that requires the modification.

To set the NDMP version on Celerra data movers so that the data mover negotiates only at the specified NDMP version or an earlier version:

1. Log in as root or as a Windows Administrator to the Celerra Control Station.
2. At the command prompt, type:

```
cd /nas/server/slot_#
```

where *slot_#* refers to the server number.

For example, `/nas/server/slot_2/netd` contains the configuration files for `server_2`.

3. Open the `netd` file in a text editor such as `vi`.
4. At the end of the NDMP string in the `netd` file, type:

```
proto=ndmp_version_#
```

For example, the resulting NDMP string is this when setting the NDMP version to 3.

```
ndmp port=10000 proto=3
```

5. Save the file.
6. Reboot the data mover by typing this command.

```
server_cpu server_name -reboot -m now
```

How to set the `ntape` parameter

To help avoid tape drive issues, set the `ntape` parameter on the Celerra filer. For every tape drive discovered on a particular data mover there must be a corresponding value set for the NDMP `ntape=#` value. For example, if a data mover has five tape drives configured on it, set the parameter to NDMP `ntape=5`.

To modify the parameter:

1. With a text editor, open the `/nas/server/slot_#/param` file, where `slot_#` correlates directly to the server number. For example, `/nas/server/slot_2/netd` contains the configuration files for `server_2`.

2. Add or modify this line.

```
NDMP ntape=n
```

Note: The value of *n* cannot be greater than 8.

3. In order for the changes to take effect, reboot the data mover.

How to find the device pathname for a Celerra host

The pathname of the media device is required before the autochanger for NDMP backups and recoveries can be configured. Use the pathname to configure the autochanger with the `jbconfig` program, as described in [“Configuring library support for NDMP” on page 530](#).

Note: This procedure is only an example. For the correct syntax and usage, refer to the Celerra documentation.

To identify the device pathname, perform *one* of these actions.

- ◆ Re-create all devices and view all nondisks by typing the following commands at the command prompt:

```
Celerra server_devconfig movername -create -scsi -all
Celerra server_devconfig movername -list -scsi -nondisks
```

- ◆ Obtain the device pathname through the Celerra Administrator program.

To access the **Celerra Administrator** program:

- a. In the browser window, type the following URL:

```
http://EMCcontrolhostIP:8000/top_level.htm.
```

- b. Type your username and password.
- c. Use the **Celerra Administrator program** to list and/or determine SCSI devices.

Note: If the NDMP tape server is running version 2 or does not support NDMP_CONFIG interfaces, locate the autochanger handle in the Celerra Administrator program.

Application information variables

In addition to the standard application information variables, HIST=y and UPDATE=y, that are required for all vendors, [Table 101](#) lists Celerra-specific variables that may be required. Type these variables in the Application Information attribute of the Client resource, as described in [“Configuring an NDMP Client resource” on page 535](#).

Table 101 Celerra variables

Variable	Required	Values and meaning
DIRECT= y/n	Yes for DAR operations	This value must be set to y if you are performing a DAR recovery. If you are not performing a DAR recovery, set the value to n . “Performing DAR backups” on page 541 provides additional information about DAR.
EMC_EDIR nn =	No	This string value identifies a directory to be excluded from the backup. The asterisk (*) is accepted as a wildcard as the last character. Multiple directories can be included by incrementing the number; for example: <ul style="list-style-type: none"> EMC_EDIR01=/fsX/DIRx EMC_EDIR02=/fsX/DIRy This variable is supported with Celerra version 5.5 and greater.
EMC_EFILE nn =	No	This string value determines which files are excluded from backup. The asterisk (*) is accepted as a wildcard, but it must be the first or last character in the string (or both). Multiple files can be included by incrementing the number; for example: <ul style="list-style-type: none"> EMC_EFILE01=*mp3 EMC_EFILE02=temp* This variable is supported with Celerra version 5.5 and greater.
OPTIONS=NT	Yes for ACL restoration	This value must be set to make sure all ACLs are recovered when NT data is contained in the backup path. In addition to setting this variable, axttrp must exist in the /nas/server/slot_#/netd file.
SNAPSURE=Y	No	This option is used to decrease the backup time for an Celerra host when DX is integrated in the NetWorker environment.

Char and Block Special Files

During recovery, the Celerra filer skips char and block special files. The following error message will be displayed:

```
Warning: /fs1/SPE_REL/my.char_file has an unknown file type, skipping
```

EMC Centera

The *EMC Centera Backup and Recovery Module Release 2.01 Installation and Administrator's Guide* and the *EMC Centera Backup and Recovery Module Release Supplement* provide information about the EMC Centera® Backup and Recovery Module software .

The *EMC NetWorker Software Compatibility Guide* provides a complete list of supported versions.

EMC IP4700

These sections provide information about autochanger configuration and application information variables for the EMC IP4700 host. The *EMC NetWorker Software Compatibility Guide* provides a complete list of supported versions.

How to find the device pathname for an EMC IP4700 host

The pathname of the media device is required before the autochanger for NDMP backups and recoveries can be configured. The device pathnames can be found through the IP4700 Administrator web interface. Use the pathname to configure the autochanger with the **jbconfig** program, as described in [“Configuring library support for NDMP” on page 530](#).

To obtain the autochanger and tape drive device pathnames:

1. In the browser window, access the **EMC IP4700 Administrator** program at this URL.
http://IP4700name/
2. Click **Tape Drives**.
3. Type the **tape list** command.
4. Use the resulting values to configure the autochanger and tape drive devices for the NetWorker software.

Note: If the NDMP tape server is running version 2 or does not support NDMP_CONFIG interfaces, locate the autochanger handle in the EMC IP4700 Administrator program.

Application information variables

In addition to the standard application information variables, HIST=y and UPDATE=y, that are required for all vendors, [Table 102 on page 565](#) lists IP4700-specific variables that may be required. Type these variables in the Application Information attribute of the Client resource, as described in [“Configuring an NDMP Client resource” on page 535](#).

Table 102 EMC IP4700 variables

Variable	Required	Values and meaning
FAST_INCREMENTAL=y	No	Performs a fast incremental backup. This function works only if fast incremental is enabled on the volume. You must have the SnapView/IP option to perform a fast incremental backup. The default is y .
SNAPSHOT=y	No	Backs up a snap copy of the file system. This function only works if snap copy is enabled on the volume. You must have the SnapView/IP option to use snap copy. The default is n , unless FAST_INCREMENTAL is set to y . Then, SNAPSHOT is set to y .
NO_ACLS=y	Yes	On Microsoft Windows systems, set this value to y when backing up a Windows system to ensure that ACLs are not backed up. Do not set this value to n when backing up Windows files with ACLs. The default is n .

Auspex

These sections provide information about limitations, autochanger configuration, and application information variables for the Auspex host. The *EMC NetWorker Software Compatibility Guide* provides a complete list of supported versions.

Auspex-Specific considerations with NDMP

These are NDMP issues that are specific to Auspex filers.

Auspex NS3000 requirements

In order to support Auspex NS3000:

- ◆ Connect the robot to channel 6 of the SCSI controller. To confirm that the robot is connected to the correct channel, inspect the device filename under the /dev/raxac directory. It should display a channel similar to *fsp0c6t0*.
- ◆ To use snapshots, a cache device must be reserved. The appropriate Auspex documentation provides more information about snapshots.

How to back up large files with Auspex

By default, support for files larger than 2 GB is not enabled for an Auspex backup. This allows for use of a standard **gtar** tape format.

To enable support for files larger than 2 GB:

1. Open the `/usr/AXndmp/etc/config` file on the NDMP host.
2. Remove the comment marks for the line containing this text.

```
ALLOW_TAR_EXTENSION
```

3. Save the modified file.

Note: If you modify the system to support large files, the tapes will be in nonstandard **gtar** format.

DD-Type backup limitations and requirements

DD-type backups have these limitations and requirements.

- ◆ HIST=y is not supported. Set this value to HIST=n.
- ◆ DD-type backups are only supported with NetOS V4.1P3 or later.

Autochanger configuration tips

Configure the Autochanger resource to have these minimum timeout values.

- ◆ Eject Sleep: 10
- ◆ Cleaning Delay: 60
- ◆ Unload Sleep: 10
- ◆ Load Sleep: 90
- ◆ Deposit Timeout: 15
- ◆ Withdraw Timeout: 15
- ◆ Port Polling Period: 3

Auspex limitations

These limitations apply to Auspex backups and recoveries.

- ◆ Root partition backups are not supported. Do not back up the root partition.
- ◆ File-by-file recoveries should not exceed 10,000 files per recovery.

To recover a larger number of files, perform *one* of these steps.

- Set up multiple save sets for a given client to break the file system into directory-level save sets rather than whole volumes.
- Perform a save set recovery by using the NetWorker User program, **nwrecover**, or the **nsrndmp_recover** command from the command prompt.

How to find the device pathname for an Auspex host

The pathname of the media device is required before the autochanger for NDMP backups and recoveries can be configured. The device pathname for an Auspex computer is located in the *messages* file at `/var/adm/messages`. Use the pathname to configure the autochanger with the **jbconfig** program, as described in [“Configuring library support for NDMP” on page 530](#).

The Auspex documentation provides information about adding a SCSI device.

The *messages* file contains the list of devices, for example:

```
Jan 18 10:32:22 nightcap FSP_0[1611]:fsp0c7t0:STK      9714
[ Medium_Changer ][ Fast ] [ min:1792 ]
Jan 18 10:32:22 nightcap FSP_0[1611]:fsp0c7t1:Quantum DLT4000 [ Tape
]
[ Not Negotiated ] [ min:1808 ]
Jan 18 10:32:22 nightcap FSP_0[1611]:fsp0c7t2:Quantum DLT4000 [ Tape
]
[ Not Negotiated ] [ min:1824 ]
```

Note: If the NDMP tape server is running version 2 or does not support NDMP_CONFIG interfaces, determine the autochanger handle from the device list.

Application information variables

In addition to the standard application information variables, HIST=y and UPDATE=y, that are required for all vendors. [Table 103 on page 567](#) lists Auspex-specific variables that may be required. Type these variables in the Application Information attribute of the Client resource, as described in [“Configuring an NDMP Client resource” on page 535](#).

Table 103 Auspex Variables

Variable	Required	Values and Meaning
DIRECT= y/n	Yes for DAR	This value must be set to y if you are performing a DAR recovery. If you are not performing a DAR recovery, set the value to n . The default is n . “Performing DAR backups” on page 541 provides additional information about DAR.
SNAPSHOT= y	No	Enables or disables snapshots. The default is n .

Procom NetFORCE

These sections provide information about autochanger configuration for the Procom host. The *EMC NetWorker Software Compatibility Guide* provides a complete list of supported versions.

How to find the device pathname for a Procom NetFORCE host

To determine the device pathname, log in as root and type the following command:

```
status dm
```

NetFORCE responds with a list of autochanger and media device names. Use the appropriate device name when configuring the autochanger with the **jbconfig** program, as described in [“Configuring library support for NDMP” on page 530](#).

Note: If the NDMP tape server is running version 2 or does not support NDMP_CONFIG interfaces, you must determine the autochanger handle. On Procom NetFORCE, the SCSI device name format is *isp1tSSL[L]*, where *isp1* is the autochanger handle. The Fibre Channel device format is *ffx1tSSL[L]*, where *ffx1* is the autochanger handle.

Postconfiguration requirements for Procom NetFORCE host

After using the **jbconfig** program to configure an autochanger for a Procom NetFORCE host:

1. Reset the autochanger by typing the following command.

```
/usr/sbin/nsrjb -HE
```

2. To read previously-labeled tapes back into the database, inventory the autochanger.

```
/usr/sbin/nsrjb -IE
```

Mirapoint

These sections provide information about requirements and autochanger configuration for the Mirapoint host. The *EMC NetWorker Software Compatibility Guide* provides a complete list of supported versions.

Requirements

These requirements apply to the Mirapoint system.

- ◆ After restoring a full backup, reboot the Mirapoint system. The system does not need to be rebooted after an incremental recovery.
- ◆ The application information variable `MIRA_OPTIONS=` (`fromimagefull=`) must be set. The (`fromimagefull=`) value allows the user to perform a full image backup and then perform message (file) based backups by using the date of the image in order to perform the selection.

Device pathname for a Mirapoint host

The device pathname is required to successfully run the `jbconfig` program. The device pathname is `/dev/nrstn`, where `n` starts at 0 and increases one number for each tape drive. This value is constant. Use the pathname to configure the autochanger with the `jbconfig` program, as described in [“Configuring library support for NDMP” on page 530](#).

Once the autochanger is configured, certain attributes must be modified in the Autochanger resource window. Set the **Load Sleep** and **Eject Sleep** attributes to these values:

- ◆ Load Sleep to 90
- ◆ Eject Sleep to 30

Note: If the NDMP tape server is running version 2 or does not support `NDMP_CONFIG` interfaces, you must type the autochanger handle, `/dev/ch0`, when running `jbconfig`.

BlueArc

BlueArc systems provide network-attached, fixed storage solutions to share, manage, and protect data. This ensures continuous availability and simplified data management.

When configuring a BlueArc system, keep these points in mind:

- ◆ When performing NDMP recovery operations, a `$_NDMP_` directory may be created at the root level of the file system to which the data is being recovered. This directory holds the file list that the NetWorker server passes for an index recovery, if that file list contains more than 1,024 filenames. Do not change the directory and its contents during an active recovery operation. If no recovery is in progress, the directory may be deleted.
- ◆ `NDMP_BLUEARC_FH_NAMETYPE=UNIX`, an application information variable (also known as an NDMP Environment Variable), must be specified in the Client resource.
- ◆ The backup command type, also known as the backup application name, is **dump**.

- ◆ While performing NDMP backup and recovery operations, a message similar to the following may appear:

```
NDMP session-Unknown environment variable name ignored.
```

You can ignore this message, as it does not impact the operation.

The BlueArc's documentation provides a complete information on configuring a BlueArc system for NDMP operations.

SnapImage software

The NetWorker SnapImage Module is a high-performance storage solution that backs up and recovers high-density file systems across a LAN or SAN. It is based on NDMP and provides full-image, block-level backups and recoveries, allowing large amounts of data to be backed up quickly, which reduces the backup window. The SnapImage software backs up high-density file systems faster than non-NDMP based file-based backup systems. It supports full backups as well as differential backups, which back up only the blocks that have changed since the last full backup. It can recover data at the block level, and also can recover specific files and directories at the volume level.

The SnapImage Module Installation and Administrator's Guide and Release Notes provide instructions on installing, configuring, and using the SnapImage software.

Filers that act as tape servers only

This section provides information about filers that act as tape servers only.

DinoStor TapeServer

These sections discuss the DinoStor TapeServer and the autochanger configurations.

Configuring the DinoStor TapeServer

The DinoStor software provides a web-based interface for administering and controlling the TapeServer settings.

Ensure that the following are set when configuring the server:

- ◆ On the Password page of the Configure tab, specify the password for administering the DinoStor TapeServer, not the NDMP password.
- ◆ When configuring the DinoStor TapeServer, set the NDMP version to 3 and the port number to 10000 on the NDMP page of the Configure tab.
- ◆ When connecting an autochanger to a DinoStor TapeServer, shut down the DinoStor TapeServer and power down. Attach the new devices and reboot the system. You can reboot or shut down the system from the web interface.
- ◆ Only SCSI tape devices are supported.
- ◆ DDS is not supported, since the DinoStor TapeServer is not fibre-equipped.
- ◆ GigE and 10/100 Base-T are supported.

How to specify device handles for a DinoStor TapeServer

When configuring the autochanger with the NetWorker Administration window, the DinoStor TapeServer has one hostname with multiple device handles. Use the hostname to configure the autochanger with the NetWorker Administration window, as described in ["Configuring library support for NDMP" on page 530](#).

To specify the device handles:

1. Access the **DinoStor TapeServer interface**.

2. Click the **Configure** page.
3. Click the **SCSI** tab.

When running **jbconfig**, specify the DinoStor hostname as the device that controls the robotics and the device handles as the additional devices.

How to perform a remote backup with a DinoStor TapeServer

To perform a remote backup with a DinoStor TapeServer:

1. Set up the configuration with an NDMP host, a NetWorker server, and the DinoStor TapeServer with a library attached.
2. Configure the NetWorker server.
 - a. For the **Name** attribute of the **Client** resource, specify the hostname of the NDMP server that contains the data to be backed up.
 - b. For the **Storage Node** attribute of the **Client** resource, verify that the hostname of the DinoStor server is listed first. The client directs the data to the first storage node in the list that has an enabled device and is able to receive the data.
 - c. Complete the rest of the required **Client** resource attributes and configure the NetWorker server as you would for any other NDMP backup.

[“Configuring an NDMP Client resource” on page 535](#) provides instructions on configuring the Client resource.

SnapImage or NDMP TapeServer Module

These sections discuss the SnapImage/NDMP TapeServer software configurations and requirements.

Finding the device pathname for a SnapImage Module device

The required steps for determining the device pathname are different for Solaris and HP-UX computers. Complete the instructions for the appropriate platform. Use the pathname to configure the autochanger with the NetWorker Console Administration window as described in [“Configuring library support for NDMP” on page 530](#).

How to identify the device pathname for a Solaris computer

To identify the device pathname:

1. Log in as root on the host.
2. Determine the media device pathname by typing the following command.

```
ls -l /dev/rmt/*
```

The computer responds with the list of device filenames.

```
lrwxrwxrwx 1 root root 03 Nov 17 12:03 /dev/rmt/0mbn ->
../../../../devices/pci@1f.0/scsi@2/st@1,0:mbn
```

where:

- ◆ /st@1,0 is the SCSI ID field for the media device.
- ◆ /dev/rmt/0mbn is the media device pathname.

If the NDMP tape server is running version 2 or does not support NDMP_CONFIG interfaces, determine the autochanger handle by typing the following command:

```
ls -l /dev/rsjb*
```

The computer responds with a list of *rsjb* device handles.

```
lrwxrwxrwx  1 root    other      45 Jan 11 13:35 /dev/rsjb2 ->
../devices/pci@1f.0/scsi@2,1/sjb@1,0:8r
```

where:

- ◆ `:8r` identifies the autochanger robotics.
- ◆ `/sjb@1,0` is the SCSI ID field for the *rsjb* device.
- ◆ `/dev/rsjb2` is the autochanger handle.

How to identify the device pathname for an HP-UX computer

To display the device pathname, log in as root on the host, use one of the following methods:

- ◆ Use the `ioscan` command by typing the following command:

```
ioscan -fnC tape
```

- ◆ Use the SAM utility.
 - a. Start the utility.
 - b. Select **Peripheral Devices**.
 - c. Select **Tape Drives**.
 - d. Highlight the appropriate tape drive and select **Show Device Files** from the **Action** menu.

Note: If the NDMP tape server is running version 2 or does not support NDMP_CONFIG interfaces, use the `ioscan` command or SAM utility to obtain the autochanger handle.

How to perform a remote backup with the SnapImage/NDMP TapeServer software

To perform a remote backup:

1. Install the NetWorker software on the server designated as the NetWorker server.
2. Install the SnapImage Module/NDMP TapeServer software on the server designated as a tape server.
 - a. If you are backing up the data to the NetWorker server, install the SnapImage Module/NDMP TapeServer software on that NetWorker server.
 - b. If you are backing up the data to a different NDMP server, install the SnapImage Module/NDMP TapeServer software on the host to which the data is being backed up.

The EMC NetWorker SnapImage Module Installation and Administrator's Guide, and its Release Notes provide instructions on installing the SnapImage Module/NDMP TapeServer software.

Note: Do not use the configuration instructions in the SnapImage Module guide. Instead, use the configuration instructions provided in this chapter for the NDMP TapeServer software.

3. To allow other servers to access the SnapImage server:
 - a. Log in as root on the host.
 - b. Run the **ndmp_passwd** command, located in `/usr/ndmphome/bin`.
 - Use this syntax:

```
ndmp_passwd -u user
```

where *user* is the root or administrator name of the SnapImage server.
 - When prompted, type the password.
4. Configure the NetWorker server.
 - a. For the **Name** attribute of the **Client** resource, specify the hostname of the NDMP server that contains the data to be backed up.
 - b. For the **Storage Node** attribute of the **Client** resource, verify that the destination server for the data being backed up is listed first.

The client directs the data to the first storage node in the list that has an enabled device and is able to receive the data.
 - c. Complete the rest of the required **Client** resource attributes and configure the NetWorker server as you would for any other NDMP backup.

[“Configuring an NDMP Client resource” on page 535](#) provides instructions on configuring the Client resource.

This chapter covers these topics:

- ◆ SNMP traps 574
- ◆ Configuring NetWorker SNMP notifications..... 574
- ◆ Configuring SNMP management software 576

SNMP traps

The NetWorker Simple Network Management Protocol (SNMP) Module allows NetWorker servers to send notification messages to SNMP management agents.

SNMP-enabled network management software must be configured to accept traps from the NetWorker server. For detailed information about SNMP management operations refer to your network management documentation.

The NetWorker SNMP Module uses traps to communicate NetWorker event notifications to SNMP management stations. A trap is an unsolicited notification sent from the SNMP agent (such as the NetWorker server) to the SNMP event manager.

The types of traps that the NetWorker server sends are determined when the NetWorker SNMP notification is configured within the NetWorker server. Typical traps include warnings, critical errors, and other messages from the NetWorker server. [“Configuring NetWorker SNMP notifications” on page 574](#) provides instructions on configuring the NetWorker SNMP notification.

Configuring NetWorker SNMP notifications

NetWorker software provides notifications to a variety of resources about NetWorker server events. The NetWorker SNMP Module is one of those resources. The module then forwards the notification to the SNMP management software by using the **nsrtrap** program. When you configure the SNMP notification, you include the IP address or hostname of the SNMP management server, along with other **nsrtrap** command line options, such as the SNMP community and the trap type.

In order to configure the NetWorker SNMP notification, you must first enable the NetWorker SNMP module. The *NetWorker Installation Guide* provides information on enabling and licensing the NetWorker software.

Command line options for nsrtrap

The NetWorker SNMP Module uses the **nsrtrap** program to communicate SNMP traps from the NetWorker server to the SNMP management software. [Table 104](#) lists the command line options that can be included in the Action attribute when the SNMP notification is configured.

Table 104 Command-line options for nsrtrap (1 of 2)

Option	Description
-c <i>community</i>	Specifies the SNMP community that is authorized to receive traps from the NetWorker server. SNMP communities are configured on the SNMP server. The default setting for this option is Public, which means that the public community can receive traps from the NetWorker server. For security purposes, system administrators often customize SNMP servers to limit the communities from which the server accepts traps. If a community other than Public is configured on the SNMP server, include the appropriate community name by using this option when you configure the SNMP notification.
-t <i>trap_type</i>	Sets the type of trap the NetWorker SNMP Module sends to the SNMP server. The default setting is 6, which means that this is an "enterprise-specific" trap. Because traps that the NetWorker server sends are notifications (for example, error messages), the default setting is normally correct and should not be changed. This option should be used only if you intend to send a specific trap other than a normal NetWorker notification.

Table 104 Command-line options for nsrtrap (2 of 2)

Option	Description
-s <i>specific_type</i>	<p>A generic setting that can be used to identify the type of trap the NetWorker server is sending. This option can be set to any integer value and may be used in conjunction with different SNMP notifications to distinguish different traps from the NetWorker server.</p> <p>For example, you can create multiple SNMP notifications: one for critical messages, another for warnings, and another for other events or priorities. You can then use the -s option to differentiate the various notifications so that the SNMP management software can determine which type of trap is being sent. You could create one notification called Critical SNMP Notification, and include the -s option in the Action attribute:</p> <p>nsrtrap -s 1 host</p> <p>With this setting, the SNMP management software can be configured to recognize that NetWorker traps with the specific trap type of 1 are critical messages. Additional SNMP notifications can have other settings for the -s option to further differentiate various traps from the NetWorker server.</p>
-v	Sets the output mode to verbose. In verbose mode, nsrtrap echoes the community, trap type, specific trap type, and the hostname or IP address at the command-prompt.

Modifying preconfigured NetWorker SNMP notification

The NetWorker server has a preconfigured SNMP notification that can be modified if necessary. The only modification that can be made to this notification is to add or remove command line options to the Action attribute.

To modify the preconfigured notification request:

1. In the **Administration** window, click **Configuration**.
2. Select **Notifications**.
3. Right-click the **SNMP notification request** and select **Properties**.
4. In the **Action** attribute, enter any necessary options for the **nsrtrap** command, such as the SNMP community. "[Command line options for nsrtrap](#)" on page 574 provides information about command-line options.
5. Click **OK**.

The events and priorities associated with the preconfigured SNMP notification cannot be modified. "[Creating NetWorker SNMP notifications](#)" on page 575 provides instructions on how to set different events and priorities for the SNMP notification.

Creating NetWorker SNMP notifications

To create additional NetWorker SNMP notifications:

1. In the **Administration** window, click **Configuration**.
2. Select **Notifications**.
3. Right-click the **SNMP notification request** and select **New**.
4. Enter a name for the **SNMP notification**.
5. (Optional) For the **Comment** attribute, enter a description of the notification.
6. Select the events and priorities that the notification should communicate to your SNMP server.

Note: The events and priorities cannot be modified after the notification is created.

7. For the **Action** attribute, type:

- Windows servers:

`<NetWorker_install_path>\bin\nsrtrap network_management_station`

- UNIX/Linux servers:

`/usr/sbin/nsrtrap network_management_station`

where *network_management_station* is the DNS name or IP address of the host on which the SNMP management software is running.

Include options for **nsrtrap**, such as `-c community`, in this attribute if necessary. [“Command line options for nsrtrap” on page 574](#) provides more information about command-line options.

8. Click **OK**.

Configuring SNMP management software

In order for the SNMP management software to accept traps sent by NetWorker servers, it must be configured to recognize the traps. Configuration procedures vary by the type of management software you are using.

For specific instructions on configuring the types of acceptable traps, refer to the SNMP management software documentation.

NetWorker SMI Network Management Private Enterprise Code

When configuring management software to accept traps, you must also indicate the specific type of trap to accept. Use the Structure of Management Information (SMI) Network Management Private Enterprise Code that applies to the specific network application that will send traps to the software. The Private Enterprise Code for the NetWorker server is 160 (the complete code is .1.3.6.1.4.1.160).

Receiving traps in the SNMP network management software

Typically, once the network management software is configured to accept traps from NetWorker servers, an icon of each NetWorker server appears on the network management console. These examples show how the software can then be configured:

- ◆ To indicate that a trap was received (for example, the NetWorker server icon may blink or change color).
- ◆ Track pending, alert, and other configured messages.
- ◆ Separate traps into event categories, such as Error Events, Status Events, Threshold Events, Configuration Events, Application Alert Events, or All Events. For information on how to set up SNMP trap templates, refer to the network management software documentation.

You may also want to create additional SNMP notification schemes in the NetWorker Administrator program that have different priorities and events. You can use the `-s specific-type` command line option for **nsrtrap** so that the SNMP management software can differentiate the traps sent by the various notification schemes. [“Command line options for nsrtrap” on page 574](#) provides more information about setting the `-s specific-type` option.

This chapter covers these topics:

- ◆ Supported configurations 578
- ◆ DiskXtender Data Manager file system overview 578
- ◆ Backup of DXDM file systems..... 580
- ◆ Recovery of DXDM file systems 582

Supported configurations

These configurations are supported for the backup and recovery of DiskXtender Data Manager (DXDM) file systems:

- ◆ DXDM software and NetWorker server, client, or storage node software installed on the same computer.
- ◆ DXDM software installed on a computer that is a client of a computer that is running NetWorker server, client, or storage node software.

Note: The Archive feature does not work for DXDM file systems.

The *EMC NetWorker Software Compatibility Guide* provides information about supported operating systems and file systems.

Path information

NetWorker backup and recovery requires the `/etc/dxuldm.path` file when supporting a DXDM file system. The file is automatically created during DXDM installation.

Permissions

The NetWorker daemon `nsrexecd` controls automated backup and recovery of DXDM file systems. The daemon is configured to run with set user ID (suid) root permissions. Root permissions are also required to perform manual NetWorker backup and recovery operations with DXDM file systems.

DiskXtender Data Manager file system overview

DXDM file systems use the following enhancements that are not found in standard file systems:

- ◆ The creation and retention of DMAPI information for each file.
- ◆ The ability to migrate files to a storage target.
- ◆ The ability to purge file data from the file system after migration.
- ◆ The retention of a data stub for each purged file.

Through these enhancements DXDM provides file system access to large numbers of files while storing the bulk of the file data on one or more storage target systems.

File data in a DXDM file system

When a file is placed into a DXDM file system it is available to list, view, access, and change the same as in any standard UNIX file system. The difference is that as soon as a file is placed into a DXDM file system, DMAPI metadata is created for the file. This extended metadata permits the transparent archiving of the file's data outside of the file system. Some of the DMAPI information that is tracked on each file includes:

- ◆ The file's migration status.
- ◆ The file's purge status.
- ◆ The file's data stub size.

After a period of time the file's data is migrated to a storage target. As shown in [Figure 44 on page 579](#), the storage target can be a DXSM system or an EMC Centera Storage System (EMC Centera). After a file's data is migrated it exists on both the DXDM file system and the storage target.

After a period of time, unchanged files are purged from the file system. The file system retains the file's DMAPI metadata and data stub. The data stub consists of a user-configured number of bytes from the beginning of the file.

User access to file data

[Figure 44](#) depicts eight DXDM file systems on one host system. Four of the file systems use a DXSM storage target and four use a EMC Centera target. The diagram shows that the data from each DXDM file system exists in its own namespace on the storage target.

- ◆ On a DXSM storage target, relative pathnames and capabilities are used to identify files.
- ◆ On a EMC Centera storage target, the EMC C-Clip™ data is created to identify each file.

This storage target namespace information is not required by DXDM file system users for access to the files. Users need only know the full pathname of a file on the DXDM host system or, when access is provided over NFS, its relative pathname from the file system's NFS mount point.

When a file on a DXDM file system is changed it is marked as not migrated. Any previously migrated data for the changed file is retained on the storage target but renamed with a version label. When a file is deleted from a DXDM file system it is fully removed. Any previously migrated data is retained on the storage target and renamed with a version label and a deleted label.

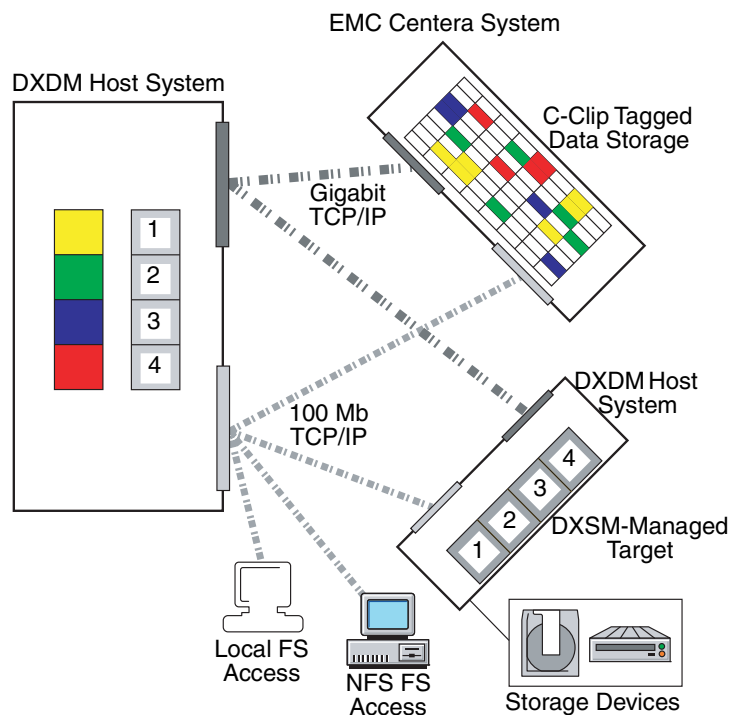

Figure 44 Prototypical DXDM installation

Backup of DXDM file systems

A DXDM file system consists of files and metadata. The files can be in a variety of migration and purge states. The metadata is contained in the file systems's DMAPI attributes file. [Table 105](#) shows the types of files and metadata that can exist in a DXDM file system and notes the types that are included in a NetWorker backup.

Table 105 DXDM file system data types included in a NetWorker backup

Data type	Included
New files which have not been migrated.	Yes
Changed files which have not been migrated since being changed.	Yes
Files which have been migrated but not purged.	Yes
Data stubs for files which have been migrated and purged.	Yes
File data which exists only on a storage target system.	No
DMAPI metadata.	Yes ¹

1. The DMAPI metadata is included by default. It can safely be excluded. [“Excluding the DMAPI attributes file” on page 580](#) provides more information.

File data which has not changed since being migrated is protected by the storage target. NetWorker backup automatically excludes this data from its client/save sets when the data has been purged. This results in these benefits:

- ◆ Smaller client/save sets.
Purged data which is protected on the storage target is excluded from the client/save set. This is normally the bulk of the data in a DXDM file system.
- ◆ Much faster backups.
In addition to the time savings derived from the smaller client/save set, NetWorker backup prevents the lengthy process of retrieving purged file data from the storage target.

DXDM file system client/save sets should exclude the DMAPI metadata. [“Excluding the DMAPI attributes file” on page 580](#) provides more information .

Backups of a DXDM file system are performed in the same manner as backups of a standard file system. Backups can be performed on a scheduled basis or manually. Both methods require root permissions. [Chapter 4, “Backup Groups and Schedules”](#) provides more information on scheduling backups. [Chapter 2, “Backing Up Data”](#) provides more information on information on manual backups.

Excluding the DMAPI attributes file

Every DXDM file system has a DMAPI attributes file which stores volatile DMAPI metadata. This file does not need to be backed up because it is re-created during the recovery process. Since these files can become quite large, create a global Directive resource to simplify the exclusion process.

To exclude a DMAPI attributes file:

1. Create a global Directive resource which excludes .DMATTR files. DXDM stores DMAPI attribute information in files located at the top level of each file system. The filename for these files is .DMATTR.
2. When creating the global Directive resource, use the Application Specific Module named Skip to exclude .DMATTR files. [Chapter 6, “Directives”](#) provides more information on directives.
3. Apply the **Directive** resource when creating client/save sets for the file system.

Aborted backups

A DMAPI process is initiated whenever when a backup of a DXDM file system occurs. DXDM assigns a DMAPI session label of DXULDMLIB to this type of process. At the conclusion of a successful backup the process is removed.

If a backup is aborted, the DXULDMLIB process exists as a defunct process. Defunct DXULDMLIB processes exist as process table entries and use no system resources. These processes normally do not cause problems and are removed when the system is rebooted. However, they can be removed manually. [“How to remove a defunct DXULDMLIB process” on page 581](#) provides details. [“Viewing existing DMAPI processes” on page 581](#) provides information on how to determine whether a defunct DXULDMLIB process exists.

Viewing existing DMAPI processes

To view all DMAPI processes on a DXDM host system:

1. Log in as root on the DXDM host system.
2. Create the DXDM environment.

Use the correct command and file for the current shell:

- C shell (csh):

source /opt/dxuldm/etc/dxuldm.login

where */opt/dxuldm* is the full path to the DXDM installation directory.

- Korn shell (ksh) or Bourne shell (sh):

./opt/dxuldm/etc/dxuldm.profile

where */opt/dxuldm* is the full path to the DXDM installation directory.

3. Type the **prtdmssession** command:

prtdmssession

The **prtdmssession** command lists each existing DMAPI session.

How to remove a defunct DXULDMLIB process

Note: Do not remove active DMAPI sessions. If active sessions are removed, DXDM processes terminate and file system activity is blocked until those processes are restarted.

To remove a defunct DXULDMLIB process:

1. Log in as root on the DXDM host system.
2. Create the DXDM environment. [“Viewing existing DMAPI processes” on page 581](#) provides details.

3. Type the **prtdmsession** command.
4. Find the listing which has **DXULDMLIB** in the **Session Info** field and note the integer in the listing's Session ID field.
5. Type the **deldmsession** command:

```
deldmsession -s DXULDMLIB -i session-id -n
```

where *session-id* is the integer from the defunct DXULDMLIB process's Session ID field.

Recovery of DXDM file systems

Recovery of a DXDM file system consists of restoring data from a client save set and synchronizing the file system's DMAPI information with the data on the storage target.

Initiating a recovery

Recovery of backed-up data from a DXDM file system is performed by using the same procedures that are used for a standard file system. [Chapter 13, "Recovering Data"](#) provides details. DXDM file system recovery can consist of individual files, directories, or a file system.

With DXDM file systems, file data must be recovered into the same file system from which it is backed up. Attempting to recover backed up data into a new file system causes:

- ◆ The unavailability of all data on the storage target.
- ◆ The DXDM processes to stop responding.

This requirement is based on the nature of the DMAPI metadata that DXDM file systems use to locate and access data on the storage target. The DMAPI metadata uses full pathnames. If the file-system mount point changes because of a recovery into a new file system, the pathname information in the metadata becomes inaccurate.

Recovered files list

As part of the recovery process each restored file's pathname is listed in a file on the DXDM host system. DXDM uses this information to synchronize its metadata. ["File system synchronization" on page 583](#) provides details.

When a recovery is complete, all data in the file system is available without waiting for the synchronization process. Data on the storage target becomes available after synchronization.

This data require synchronization:

- ◆ Migrated and purged file data.
- ◆ Purged and deleted file data. ["Restoring deleted files and previous file versions" on page 583](#) provides details.

Restoring deleted files and previous file versions

DXDM file systems retain file versions. This allows administrators to restore specific versions of files. In a DXDM file system, a file is migrated when it is first placed into the file system and again after each change. Each of these migrations cause a new version of the file to be created on the storage target.

To restore a previous version of a file, whether or not the file still exists in the file system:

1. Recover the file from the client/save set that backed up the desired version. [“Recovering an earlier version of a file” on page 320](#) provides information on this procedure.
2. Complete the synchronization process. [“File system synchronization” on page 583](#) provides details.
3. To expedite the synchronization of a particular file, complete the procedure described in [“Manually synchronizing a file” on page 584](#).

The synchronization process restores the data for the version of the file that is recovered. It will also restore data for a file which has been inadvertently deleted. At the conclusion of the synchronization process the recovered file version or deleted file is available.

File system synchronization

As part of a recovery of one or more files into a DXDM file system, the **recover** program creates a file that contains a list of each recovered file.

This list file has a pathname with this format:

```
/opt/dxuldm/adm/recdir/rec.date.pid
```

where:

- ◆ /opt/dxuldm is the installation directory for DXDM.
- ◆ *date* is the date of the recovery.
- ◆ *pid* is the process ID of the NetWorker client process.

DXDM uses the list file to rebuild the file system’s DMAPI attributes file. This process synchronizes the file system’s metadata with the data on the storage target.

Note: Do not remove a list file created by the **recover** program. Automatic file synchronization will not occur if a list file is removed.

Manual synchronization can be conducted without a list file. [“Manually synchronizing a file” on page 584](#) provides more information. [“Automatic synchronization” on page 584](#) describes that synchronization is an automatic process which does not require administrative intervention.

[“Manually synchronizing a file” on page 584](#) describes how make a file’s data available more quickly.

If NetWorker **recover** cannot write to the recdir directory, each recovered file is synchronized as it is recovered. This file-by-file synchronization significantly slows down the recovery process.

The `readdir` directory is created during the installation of DXDM. NetWorker **recover** will be unable to write to it if the directory is removed or if the partition on which it is mounted becomes full.

Automatic synchronization

DXDM uses the list file created by NetWorker **recover** to determine which files require synchronization. Each file on the list is synchronized. If synchronization does not complete, DXDM retries until all files on the list have been synchronized. After all files are synchronized, the list file is removed.

Automatic synchronization is performed by the script **dxuldmcronscript** which is invoked by root's **crontab** every 10 minutes. The **cron** job to invoke **dxuldmcronscript** is placed in root's **crontab** when DXDM is installed.

Manually synchronizing a file

To make a file available before automatic synchronization is complete, use manual synchronization. This uses the DXDM command-line utility **dxuldmrecover**.

To manually synchronize a file:

1. Log in as root on the DXDM host system.
2. Create the DXDM environment. Step 2 in [“Viewing existing DMAPAPI processes” on page 581](#) provides details.
3. Run the **dxuldmrecover** utility:

```
dxuldmrecover -p filepath
```

where *filepath* is the full path to the file that is being synchronized.

The **dxuldmrecover** utility takes the full path of a file as its argument. It can be invoked from a script to manually synchronize multiple files.

When synchronization is complete this message appears:

```
Successfully recovered file filepath.
```

Note: A DXDM file system can be manually synchronized by using the **dxuldmrecoverfs** utility. The *EMC DiskXtender Data Manager, Release 2.6, Installation and Administrator's Guide* provides more information.

This chapter covers these topics:

- ◆ Microsoft Automated System Recovery 586
- ◆ NetWorker support for ASR 586
- ◆ ASR Limitations and special considerations 587
- ◆ ASR backup 588
- ◆ Creating an ASR disk 590
- ◆ Using the ASR disk to recover a NetWorker client 592

Microsoft Automated System Recovery

Microsoft Automated System Recovery (ASR) for Windows XP and Windows Server 2003 enables backup and recovery applications to implement an automated disaster recovery solution.

ASR is similar to the Windows NT Emergency Repair Disk (ERD), but ASR has additional features. Both ERD and ASR require that you prepare a recovery disk in advance. While the ERD requires user interaction to repair selected components of the Windows operating system, ASR provides an automated solution for complete disaster recovery of a failed computer.

ASR is installed as a standard component of the Windows XP and Windows Server 2003 operating systems. No additional Microsoft software is required.

Note: The automated system recovery feature for Microsoft Windows Server 2008 and Windows 7 is known as Offline System State Restore (OSSR) and is not covered in this chapter. NetWorker support for OSSR is covered in [Chapter 24, "Support for Windows 2008 / 2008 R2 / Windows 7 Disaster Recovery."](#)

Microsoft ASR documentation

Microsoft recommends use of ASR as a last resort, after all other system recovery options (such as Safe Mode Boot and Last Known Good) have been exhausted. However, ASR recovery is appropriate in a disaster recovery situation, such as a failure of the system drive.

NetWorker support for ASR

NetWorker software supports ASR on NetWorker clients that run Windows XP Professional or Windows Server 2003. ASR is not supported for NetWorker servers or storage nodes.

ASR is *not* supported for NetWorker clients configured with a shared disk. This applies to stand-alone clients, as well as clients operating in an MSCS cluster environment. The *EMC NetWorker Disaster Recovery Guide* provides disaster recovery information about these configurations.

NetWorker ASR save set

The NetWorker ASR save set contains all the information necessary to return the failed computer to its condition at the time of the last ASR backup, including:

- ◆ An automated reinstallation of Windows
- ◆ Restoration of the system configuration
- ◆ Recovery of one or more disk volumes,

The ASR save set can be backed up by itself, or as a component of the save set All. Like the NetWorker SYSTEM save sets, ASR is backed up automatically at level full.

Usage overview

Because ASR is the recommended NetWorker disaster recovery method for Windows XP Professional and Windows Server 2003 NetWorker clients, perform ASR backups on a regular basis.

You can perform an ASR backup by using either of these methods:

- ◆ As part of a regularly scheduled group backup, configured by using the NetWorker Administrator program.
- ◆ In a manual backup by using the NetWorker User program.

You can create an ASR disk by using either of these methods:

- ◆ By restoring the ASR save set on the NetWorker client computer.
- ◆ By performing a directed recovery of the ASR save set to a different NetWorker client computer.

In the event of a disaster on the NetWorker client, use the ASR disk to perform an ASR recovery. This must be done locally, on the failed NetWorker client computer.

Note: If a current ASR disk or ASR save set is not available for the failed NetWorker client computer, you must use the legacy NetWorker disaster recovery method. The EMC NetWorker Disaster Recovery Guide provides more information .

Network connection names

Microsoft assigns a default name to each client network connection. If possible, do not rename these network connections. If a default network connection name is renamed, one must edit the net.cfg file on the ASR disaster recovery diskette so that the new names are replaced with the default names that were originally assigned by Microsoft. [“Posting ASR disk creation task” on page 592](#) provides details.

ASR Limitations and special considerations

This section describes limitations and special considerations that apply to ASR backup and recovery.

IMPORTANT

Refer to the Microsoft Knowledge Base article, 818903, for information about supported configurations of Windows XP at the time of backup and recovery.

FAT16 partitions are not supported

Microsoft ASR does not support recovery of disk partitions in FAT16 (also called FAT) format.

To perform an ASR recovery on a computer that has a FAT16 partition:

- ◆ Select the **pause during recovery** option while creating the ASR disk. [“Creating an ASR disk” on page 590](#) provides more information about this option.
- ◆ When the ASR recovery operation pauses, clear the FAT16 partition to exclude it from the recovery. [“Using the ASR disk to recover a NetWorker client” on page 592](#) provides more information about performing ASR recoveries.

After you have completed the ASR recovery and rebooted, recover the FAT16 partition in a separate, non-ASR NetWorker recovery operation. [Chapter 13, “Recovering Data”](#) provides information about recovering data.

OEM recovery CDs are not supported

Many computer manufactures, such as Dell, Hewlett Packard, and IBM provide a recovery CD or DVD with each system. These recovery disks typically contain the Windows installation files, plus any additional software included with the system. Although these recovery disks contain a complete set of Windows installation files, they cannot be used to perform an ASR recovery.

Note: To perform an ASR recovery, you must have an official Microsoft Windows installation CD for the version of Windows you are recovering. The EMC NetWorker Disaster Recovery Guide and the OEM documentation provide information. If you have only an OEM recovery CD that includes the Windows installation files.

Vendor-specific drivers must be installed after Windows installation

ASR recovery can only be done on hardware components supported by the Windows installation media. Drivers for vendor-specific hardware must be installed *after* the Windows installation is complete.

For example, the IBM Thinkpad network interface card (NIC) is not supported by the Windows installation media, and will cause ASR recovery to fail. For more information on hardware supported by the Windows installation media, refer to the Microsoft documentation.

ASR backup

Include ASR in a scheduled group backup for each Windows XP Professional and Windows Server 2003 NetWorker client. When you use the ASR disk to recover a NetWorker client computer, any data and configuration changes made since the last ASR backup will be lost.

Note: The Automated System Recovery (ASR) feature in Microsoft Vista and Microsoft Windows Server 2008 is not supported with the 7.4 or later releases of the software.

How to include the ASR or VSS ASR DISK save set in a scheduled backup

Backing up save set All is the preferred method of performing scheduled ASR backups. This method ensures that the ASR or VSS ASR DISK save set includes information for all of the client's disk volumes. If individual save sets are selected, only the selected save sets are restored during an ASR recovery.

To include the ASR or VSS ASR DISK save set in a client's scheduled backup:

- ◆ In the Save Set attribute for the Client resource, enter All.
- ◆ At a minimum, select the following save sets:
 - The drive letter for %SystemDrive% (for example, C:\)
 - If VSS is not licensed and enabled, select:
 - ASR:
 - SYSTEM STATE:
 - SYSTEM DB:
 - SYSTEM FILES:
 - If VSS is licensed and enabled, select:
 - VSS ASR DISK:
 - VSS SYSTEM BOOT:
 - VSS SYSTEM SERVICES:
 - VSS SYSTEM FILESET:
 - VSS USER DATA:

[Chapter 2, "Backing Up Data"](#) provides more information about specifying save sets for a scheduled backup.

How to include ASR or VSS ASR DISK save set in a manual backup

Backup of data by selecting My Computer is the preferred method of performing manual ASR backups. This method ensures that the ASR or VSS ASR DISK save set includes information for all of the client's disk volumes. By selecting individual save sets, only the selected save sets are restored during an ASR recovery.

To include the ASR or VSS ASR DISK save set in a manual backup:

- ◆ In the NetWorker User program, click the Backup button and select My Computer to save all data.
- ◆ At a minimum, select the following save sets:
 - If VSS is not licensed and enabled, select:
 - ASR:
 - SYSTEM STATE:
 - SYSTEM DB:
 - SYSTEM FILES:
 - If VSS is licensed and enabled, select:
 - VSS ASR DISK:
 - VSS SYSTEM BOOT:
 - VSS SYSTEM SERVICES:
 - VSS SYSTEM FILESET:

Chapter 2, “Backing Up Data” provides more information about manual backups.

Creating an ASR disk

The information in this section refers to using the NetWorker User program to create an ASR disk. If NetWorker Module for Microsoft Applications is installed on the client computer, ASR is not supported. The *EMC NetWorker Module for Microsoft Applications Administration Guide* provide information about the NetWorker Module for Microsoft Applications program.

Before an ASR recovery, create an ASR disk for the NetWorker client computer that will be recovered. An ASR disk is created by using the NetWorker User program either locally, or as a directed recovery of the ASR save set.

Prerequisites

- ◆ The computer used to create the ASR disk must be running NetWorker release 7.x software.
- ◆ For critical systems, back up the ASR DISK save set frequently and create an ASR disk whenever the client computer drive configuration changes. “[ASR backup](#)” on page 588 provides more information about backing up an ASR DISK save set.
- ◆ Multiple floppy diskettes will be required to create an ASR disk.

Create an ASR disk locally

If the NetWorker client computer for the new ASR disk is not functional, perform a directed recovery of the ASR save set. “[Creating an ASR disk by using directed recovery](#)” on page 591 provides details.

To create an ASR disk locally:

1. Log in with administrator privileges to the NetWorker client computer for which you want to create the ASR disk.
2. In the NetWorker **User** program, click **Recover**.
3. In the **Source Client** dialog box, click **OK** to select the local client.
4. In the **Destination Client** dialog box, click **OK** to select the local client.
5. In the **Recover** window, mark the **ASR: save set for recovery**.
6. Click **Start**. The files for the ASR disk are saved locally in the %temp% directory.
7. When prompted to create an ASR disk for this client, click **Yes**.
8. When prompted, insert the first blank, formatted disk into the **A:** drive and click **OK**.
9. When prompted about pausing the ASR recovery to select which save sets to restore, choose one of these options:
 - **Yes** — During recovery of the NetWorker client host computer, ASR pauses and prompts for the save sets to restore. If the ASR save set was backed up as a component of save set All during a scheduled backup, or as a component of a manual backup, *all* of the client’s save sets are available to select. If the ASR save set was backed up individually during a scheduled backup, only those save sets included in the scheduled backup are available for selection.

- **No** — ASR performs a fully automated recovery of the NetWorker client host computer, without a pause. If the ASR save set was backed up as a component of save set All during a scheduled backup, or as a component of a manual backup, *all* of the client's save sets are restored. If the ASR save set was backed up individually during a scheduled backup, only those save sets included in the scheduled backup are restored.
10. Label each ASR disk after it is created.
 11. If the network connections for this client were renamed, complete the procedure described in [“Posting ASR disk creation task” on page 592](#).

Creating an ASR disk by using directed recovery

If the NetWorker client computer is not functional, you can use the directed recovery method to create an ASR disk. The directed recovery method is also useful for performing centralized NetWorker administration, and in cases where you cannot access the %SystemRoot%\Repair\nsr directory on the NetWorker client because the system is damaged.

To create an ASR disk by using directed recovery:

1. Log in with administrator privileges to a NetWorker client computer.
2. In the NetWorker **User** program, click **Recover**.
3. In the **Source Client** dialog box, select the NetWorker client for which you are creating the ASR disk and click **OK**.
4. In the **Destination Client** dialog box, click OK to select the local client.
5. In the **Recover** window, mark the **ASR: save set** for recovery.
6. Click **Start**. The files for the ASR disk are saved in the %temp% directory on the destination client (the computer you are using to perform the directed recovery).
7. When prompted to create an ASR disk for this client, click **Yes**.
8. When prompted, insert the first blank, formatted disk into drive A:\ and click **OK**.
9. When prompted about pausing the ASR recovery to select which save sets to restore, choose one of these options:
 - **Yes** — During recovery of the NetWorker client host computer, ASR pauses and prompts for the save sets to restore. If the ASR save set was backed up as a component of save set All during a scheduled backup, or as a component of a manual backup, *all* of the client's save sets are available to select. If the ASR save set was backed up individually during a scheduled backup, only those save sets included in the scheduled backup are available for selection.
 - **No** — ASR performs a fully automated recovery of the NetWorker client host computer, without a pause. If the ASR save set was backed up as a component of save set All during a scheduled backup, or as a component of a manual backup, *all* of the client's save sets are restored. If the ASR save set was backed up individually during a scheduled backup, only those save sets included in the scheduled backup are restored.
10. Label each ASR disk after it is created.

If the network connections for this client were renamed, complete the procedure described in [“Posting ASR disk creation task” on page 592](#).

Posting ASR disk creation task

When an ASR save set is created, client network connections are saved with the current client network connection name. During a disaster recovery, Microsoft ASR requires that the network connections be reconfigured by using the default name assigned by Microsoft. If the client network connections were renamed before the ASR save set was created, update the ASR disk to use the original names assigned by Microsoft.

To update the ASR disk to use the default Microsoft ASR client network connection names:

1. Using a text editor, open the net.cfg file on the ASR disk.
2. Replace all instances of the renamed client network connection with the default Microsoft network connection name.

For example, suppose the Microsoft default network connection name *Local Area Connection* was renamed *Backup Subnet*. In this case, one would replace all instances of the name *Backup Subnet* with *Local Area Connection*.

Microsoft uses these conventions to name client network connections:

- Local Area Connection
- Local Area Connection *x*
where *x* is the second, third, or fourth connection and so on.

3. Close and save the net.cfg file.

Using the ASR disk to recover a NetWorker client

ASR recovery should typically be used only if the failed computer requires a full disaster recovery (for example, if the system drive has failed). For information about other disaster recovery options, refer to the *EMC NetWorker Disaster Recovery Guide*.

During an ASR recovery, this occurs:

- ◆ All disk signatures, volumes, and partitions are restored.
- ◆ The Windows operating system is reinstalled.
- ◆ If you selected "pause during recovery" while creating the ASR disk, you are prompted to select which NetWorker backup save sets to recover.
- ◆ The NetWorker software recovers the selected backup save sets.

If you perform an ASR recovery of a Windows XP Professional client that has any type of Microsoft Windows licensing other than Enterprise licensing, you are then prompted to reactivate the Windows license.

Requirements for an ASR recovery

An ASR recovery requires:

- ◆ A current ASR disk for the computer being recovered. [“Creating an ASR disk” on page 590](#) provides more information.

If a current ASR disk or ASR save set is not available for the failed computer, use the legacy NetWorker disaster recovery method. The *EMC NetWorker Disaster Recovery Guide* provides details.

- ◆ The Microsoft Windows XP Professional or Windows Server 2003 installation CD for the computer you are recovering.

Note: Recovery CDs provided by computer manufacturer are not supported for ASR recovery. [“OEM recovery CDs are not supported” on page 588](#) provides more information about this restriction.

- ◆ The latest NetWorker backup for the computer you are recovering.

Note: If you routinely move NetWorker backup media to an offsite location for safekeeping, ensure that all necessary volumes are available before you start the recovery. To list the media associated with the files you want to recover, run `mminfo -mv` from the command prompt. The EMC NetWorker Command Reference Guide provides more information about the `mminfo` command.

Performing an ASR recovery

To perform an ASR recovery on a NetWorker client computer:

1. Start the target computer from the Windows XP Professional or Windows Server 2003 installation CD.

Note: You may need to run the BIOS setup program to configure the computer to boot from the CD-ROM drive. For instructions, refer to the computer manufacturer's documentation.

2. Watch closely at the beginning of the boot process. If prompted, press a key to boot from the CD-ROM drive.
3. During the text-mode phase of Windows setup, watch the lower portion of the screen. When prompted, press **[F2]** to display the ASR Recovery menu. Follow the instructions on the screen.
4. When prompted, insert the ASR disk into the **A:** drive and press a key to continue. ASR formats the system partition, copies files, and begins the Windows installation.

Note: Due to a Microsoft Windows 2003 ASR mode problem, when prompted to insert the ASR disk and press a key to continue, you may need to press a key several times before the system recognizes the disk and proceeds with the recovery. This problem does not occur on Windows Server 2003 systems.

If multiple diskettes are required for recovery, the recovery process may not prompt explicitly for the next diskette. Instead, a message may appear that is identical to the message that prompted you to insert the ASR diskette at the beginning of the recovery procedure. In this case, insert the next diskette and press a key to continue.

5. If you did not select the "pause during recovery" option while creating the ASR disk, a fully automated recovery is performed. There is no pause and you are not prompted to select the save sets to recover.

If you selected the "pause during recovery" option while creating the ASR disk, the NetWorker ASR Client dialog box appears during the graphical phase of the Windows installation. Expand **My Computer** to view the save sets to recover, then click **Continue**.

The save sets are marked by default and include these legacy save sets:

- SYSTEM STATE:\
- SYSTEM DB:\
- SYSTEM FILES:\

If VSS is licensed and enabled, these VSS save sets are included:

- VSS SYSTEM BOOT:\
- VSS SYSTEM FILESET:\

VSS USER DATA, VSS OTHER, and VSS SYSTEM SERVICES do not appear because they are not required to boot from ASR mode. [“Creating an ASR disk” on page 590](#) provides more information about the "pause during recovery" option.

By default, the displayed save sets represent the most recent backup. You can view and select previous backups by typing a new browse time in the Browse Time field. The browse time must be entered in time and date the **nsr_getdate** format. For example, a date can be specified by using the format mm/dd/yy or month dd, yy. The *EMC NetWorker Command Reference Guide* provides more information about **nsr_getdate**.

The VSS components and certain components cannot be correctly restored during ASR recovery. [“Components that require special handling after an ASR recovery” on page 594](#) provides information on how to ensure that all necessary components are properly recovered.

Performing a manual ASR recovery on Windows 2003 x64

For Windows 2003 x64 systems, if the ASR recovery cannot be performed automatically from the disk as outlined in the section [“Performing an ASR recovery” on page 593](#), use the following steps to manually perform the ASR recovery:

1. Create the ASR disk using the normal method outlined in [“Create an ASR disk locally” on page 590](#).
2. Install the operating system.
3. Create the drives as they were previously.
4. Copy all the ASR disk contents to the %TEMP% folder.
5. Open a command prompt and cd to the %TEMP% folder.
6. Type the following in the command prompt:

```
extractlib.cmd
extract.exe asr.sif
```

The **Recover** window now displays. From this window, you can mark the save set for recovery and start the recovery process. This will also configure the network of this system.

Components that require special handling after an ASR recovery

Due to limitations in Microsoft ASR functionality, these system state components cannot be correctly restored during ASR recovery:

- ◆ COM+ Registration Database
- ◆ Disk Quota Database

- ◆ Windows Management Instrumentation Database
- ◆ VSS writers

If the NetWorker client being recovered uses any of these components, perform this procedure after an ASR recovery:

1. Log in with administrator privileges to the target computer.
2. Start the NetWorker **User** program.
3. Click **Recover**.
4. In the **Source Client** dialog box, click **OK** to select the local client.
5. In the **Destination Client** dialog box, click **OK** to select the local client.
6. In the **Recover** window, if VSS is licensed and enabled, mark all VSS save sets for recovery, *except* VSS ASR DISK, and then go to [step 9](#) . If a VSS client license does not exist, or VSS is disabled, go to [step 7](#) .
7. Check for the presence of the COM+ Registration Database component. If it is present, select the **SYSTEM STATE** save set for recovery.
8. In the **Recover** window, select the **SYSTEM DB** save set:
 - a. Check for the presence of these components:
 - Disk Quota Database
 - Windows Management Instrumentation Database
 - b. If either of these components is present, select the SYSTEM DB save set for recovery.
9. If you selected any save sets for recovery, click **Start**.

Verifying the NetWorker client recovery

VSS is unavailable during ASR recovery. Once ASR recovery is complete and the system is rebooted, VSS is available for proper recovery of the writers. [Appendix A, "SYSTEM and VSS SYSTEM Save Sets"](#) has more information about VSS writers.

[Appendix D, "Additional Features of the Microsoft Windows Server"](#) provides information about how the NetWorker software handles the Windows system state and system-protected files.

To verify the NetWorker client recovery:

1. Reboot the NetWorker client computer and verify that the NetWorker Remote Exec and NetWorker Power Monitor services have started.
2. Use the Windows Event Viewer to examine the event logs for errors. In particular, check for these:
 - Service startup errors related to the Windows system state.
 - Errors regarding the recovery of Windows system-protected files.
3. Verify that any applications (such as Microsoft Office) that were running prior to the disaster have been properly restored.

To verify:

- a. Run each application.
- b. Open a previously saved document.

This chapter covers these topics:

- ◆ Terminology 598
- ◆ Windows Disaster Recovery overview 599
- ◆ Windows Disaster Recovery limitations and considerations 606
- ◆ Windows Disaster Recovery backups 613
- ◆ Windows Disaster Recovery operations 618
- ◆ Optimizing Disaster Recovery backups..... 641

Terminology

This section defines terms that are used in this document to describe NetWorker support for Windows Disaster Recovery technology.

- ◆ Application data — User data that is created by the application, such as log files or user data that is created with the application, such as an application database. For example, a SQL server's application data includes its databases and log files. Application data is not included nor is it recoverable from a Windows Disaster Recovery operation. Application data must be backed up and recovered with a NetWorker module such as the NetWorker Module for Microsoft (NMM).
- ◆ ASR Writer — The Volume Shadow Copy Service (VSS) writer that is responsible for identifying critical data that is needed to perform an offline restore.
- ◆ Bare Metal Recovery (BMR) — The restoration of a computer operating system and its data after a catastrophic failure such as a hard disk failure or the corruption of critical operating system components. A bare metal recovery is an automated process and does not require the manual installation of an operating system.
- ◆ Boot Configuration Data (BCD) — The BCD store contains boot configuration parameters and controls how the operating system is started for Microsoft Windows 7 and Microsoft Windows Server 2008 operating systems. A backup of this ASR Writer component is required to perform an offline restore.
- ◆ Critical Volume — A critical volume includes:
 - Any volume containing system state (see definition later in this section) files or files for an installed service, including volumes mounted as NTFS directories that contain such files. An example of an installed service would be the Exchange 2010 application binaries. However, the Exchange database and log files are not considered critical.
 - Any parent volume where a critical volume is mounted.
 - All volumes on all dynamic disks if at least one of those volumes is critical.

A current backup of all critical volumes is required to perform a Windows Disaster Recover.
- ◆ Disaster recovery — The restoration of a computer operating system and its data after a catastrophic failure such as a hard disk failure or the corruption of critical operating system components. A disaster recovery may or may not be a bare metal recovery.
- ◆ NetWorker Windows Disaster Recovery image — a bootable image that contains NetWorker binaries and a wizard to control the Windows Disaster Recovery process.
- ◆ Non-critical volume — A volume containing files that are not part of the system state or an installed service.
- ◆ Offline restore — A restore operation performed from the NetWorker Windows Disaster Recovery boot image. An offline restore is an automated process and does not require the manual installation of an operating system. A Bare Metal recovery (BMR) is an offline restore.
- ◆ Online restore — A restore operation that is performed from the regular NetWorker recover user interface. An online restore requires that the computer has been booted from an installed operating system.

- ◆ System State — All files that belong to VSS writers with a usage type of BootableSystemState or SystemService. This is required to perform an offline restore.
- ◆ User data — Data that is generated by users, typically for the purposes of a business function. A Microsoft Word document or an Excel spreadsheet is an example of user data. User data is not backed up nor is it recovered with Windows Disaster Recovery unless it resides on a critical volume. The simplest way to backup all user data is to specify the keyword *All* in the backup save set of the client resource. User data can be restored online at any time (on demand) or after a Windows Disaster Recovery operation.
- ◆ Windows Disaster Recovery — Also known as Windows DR, is a bare metal recovery of a host. NetWorker provides an automated bare metal recovery solution for Windows.
- ◆ WinPE — A bootable stripped-down version of the Windows operating system. The NetWorker Windows Disaster Recovery image contains a customized WinPE with NetWorker binaries and a wizard to control the offline restore process. Be aware that VSS writers, except for the ASR writer, are not supported in WinPE. Therefore, VSS writers are not available with a NetWorker Windows Disaster Recovery.

Windows Disaster Recovery overview

Starting with NetWorker 7.6 Service Pack 2, support has been added for Windows Disaster Recovery (DR) for NetWorker clients on the following platforms:

- ◆ Windows 2008 (x86 and x64) and Windows 2008 Server Core
- ◆ Windows 2008 R2 SP1 (x64) and Windows 2008 R2 Server Core
- ◆ Windows 7 (x86 and x64)
- ◆ Windows 7 SP1 (x86 and x64)

To support Windows Disaster Recovery on a NetWorker client, the minimum required NetWorker server and NMC Console versions are 7.5 SP3 and 7.6 SP1.

NetWorker Windows DR provides an automated Bare Metal Recovery (BMR) solution by using the Windows ASR writer and other VSS writers to identify critical volumes that are needed to perform a disaster recovery on a disabled system.

NetWorker DR is performed offline, which means that the Windows operating system is not active. This avoids the need to reinstall Windows manually and also avoids the problems that occur when restoring operating system files to an active Windows system.

To support Windows Disaster Recovery, NetWorker provides a bootable Windows Disaster Recovery image that contains NetWorker binaries and a wizard to control the disaster recovery process.

IMPORTANT

Although Windows Disaster Recovery is supported for hosts that are protected with the NetWorker Module for Microsoft Applications (NMM), there are special backup and recovery considerations that you need to know. For specific backup and recovery instructions, refer to the NMM documentation.

Offline versus online recovery

An offline recovery is an automated bare metal disaster recovery operation and does not require the manual installation of an operating system. Windows Disaster Recovery is an offline operation. For Windows 2008, 2008 R2, and Windows 7, Microsoft only supports disaster recovery that is performed offline.

Additionally, the successful recovery of the Windows system state (to the same or similar hardware) can only be achieved through offline disaster recovery. Disaster recovery backups should be taken after system components are installed, removed, or updated. This includes adding, changing, or removing Windows roles and features, or installing Windows updates.

You cannot select specific files or save sets to recover during an offline recovery. To select specific files or save sets for recovery, you must perform an online recovery. An online recovery is a typical NetWorker recovery that is performed when you need to recover only specific files or save sets. [Chapter 13, "Recovering Data"](#) provides more information about the online recoveries.

The following list contains references to information about specific online recovery operations:

- ◆ Active Directory
The *NetWorker Disaster Recovery Guide* provides more information.
- ◆ Windows Server Failover Cluster
The *NetWorker Disaster recovery Guide* provides more information.
- ◆ DFS-R
[Appendix C, "Backing Up and Restoring a Microsoft DFS"](#) provides more information.

If you are protecting a system that also hosts Active Directory, DFS-R, or Windows Server Failover Cluster, and you want to have the option to recover these items online, then you must back up the following save sets explicitly:

VSS SYSTEM BOOT:\

VSS SYSTEM SERVICES:\

VSS SYSTEM FILESET:\

If you do not back up the previously listed save sets explicitly, Active Directory, DFS-R, or Windows Server Failover Cluster applications are still recovered with a Windows Disaster Recovery operation. However, these save sets will not be available for an online recovery operation. ["Windows Disaster Recovery backups" on page 613](#) provides more information about backing up the VSS system save sets explicitly.

IMPORTANT

Online restore of VSS SYSTEM save sets is generally not supported except for the three applications (Active Directory, failover cluster, and DFS-R) listed previously. For these applications, online restore of VSS SYSTEM save sets is supported only if the same Windows OS instance is being used. The incorrect online restore of VSS SYSTEM save sets could lead to an inconsistent state of the Windows system.

Backup and recovery roadmap

Table 106 provides a roadmap of the typical Windows DR backup and recovery process. The roadmap also indicates which steps need to be performed before you attempt a Windows DR.

Table 106 Windows DR backup and restore roadmap

Backup and restore step	For more information	Do before attempting a Windows DR?
Understand Windows DR limitations	“Windows Disaster Recovery limitations and considerations” on page 606.	Yes
Plan your backups	“Back up planning” on page 613	Yes
Back up the DISASTER_RECOVERY:\ save set	“How to include Windows DR in scheduled backups” on page 614 “How to include Windows Disaster Recovery in manual backups” on page 616	Yes
Verify the backup	“How to verify that a valid disaster recovery backup exists” on page 616	Yes
Create disaster recovery boot media	“Task 1: Create the NetWorker Windows Disaster Recovery bootable media” on page 618	Yes
Meet the restore prerequisites	“Task 2: Prerequisites” on page 620	Yes
Obtain information necessary for restore	“Task 3: Gather information” on page 620	Yes
Test the Disaster Recovery wizard	“Task 4: Test the wizard” on page 621	Yes
Recover critical disks	“Task 5: Run the wizard” on page 621	
Recover non-critical disks and VSS system state data, if necessary	“Task 6: Post-Restore operations” on page 632	

Changes to the All backup save set

To support Windows DR in a NetWorker 7.6 SP2 client or higher, the behavior of the NetWorker save set All has changed significantly when backing up Windows 2008 / 2008 R2 and Windows 7 hosts. This section highlights the major changes to be aware of when using the save set All to protect Windows 2008 / 2008 R2 and Windows 7 hosts. For all other Windows operating systems, the save set All remains unchanged. [Table 107](#) highlights these changes.

Table 107 Changes to the All save set for Windows 2008 / 2008 R2 and Windows 7

Components of the All save set for Windows Server 2003 with VSS licensed and enabled	Components of the All save set for Windows 2008 / 2008 R2 and Windows 7*
VSS SYSTEM BOOT:\ VSS SYSTEM FILESET:\ VSS SYSTEM SERVICES:\ VSS USER DATA:\ VSS OTHER:\ VSS ASR DISK:\ (Windows Server 2003 only) All local physical drives	DISASTER_RECOVERY:\ (included in Full backup only) All local physical drives
<p>* For Windows Vista and for Extensible Firmware Interface (EFI) systems, Windows Disaster Recovery backups are not supported. The All save set components for Vista and EFI hosts are equivalent to a Windows 2003 host that has VSS licensed and enabled. For Windows 2008 / 2008 R2 and Windows 7, you can also revert the definition of the All save set to be equivalent to a Windows 2003 host with VSS licensed and enabled by using the VSS:DISASTER_RECOVERY=off keyword in the Save Operations attribute. "Save Operations attributes for Windows Disaster Recovery" on page 641 provides more information.</p>	

Note: VSS save sets are not included in a DISASTER_RECOVERY:\ save set and cannot be restored separately from the DISASTER_RECOVERY:\ save set. You can still back up VSS save sets for special cases such as an online recovery of Active Directory, DFS-R, or Windows Server Failover Cluster. ["Windows Disaster Recovery backups"](#) on page 613 provides more information.

In addition to Windows DR capabilities, regular file system backup and recovery is provided by specifying the save set All.

Components of the DISASTER_RECOVERY:\ save set

The new DISASTER_RECOVERY:\ save set encapsulates all of the critical volumes that are required to provide complete Windows DR capabilities. The disaster recovery backup also creates save sets for each critical volume. The critical volume save sets are named *OSSR_driveletter* where *driveletter* is the drive letter. For example, if drives C and D were identified as critical drives, they would be listed as *OSSR_C* and *OSSR_D*. If the critical volume is on a mount point, then the mount point name will also be included in the save set name. For example, if a critical volume is mounted on F:\mnt_point, then the save set name would be *OSSR_F_mnt_point*.

All save sets that are included in a DISASTER_RECOVERY:\ save set can be displayed in the NMC Administration window in either the Log tab of the Monitoring window or in the Save Set tab of the Media window. Figure 45 shows the DISASTER_RECOVERY:\ save sets in the Save Set tab of the Media window.

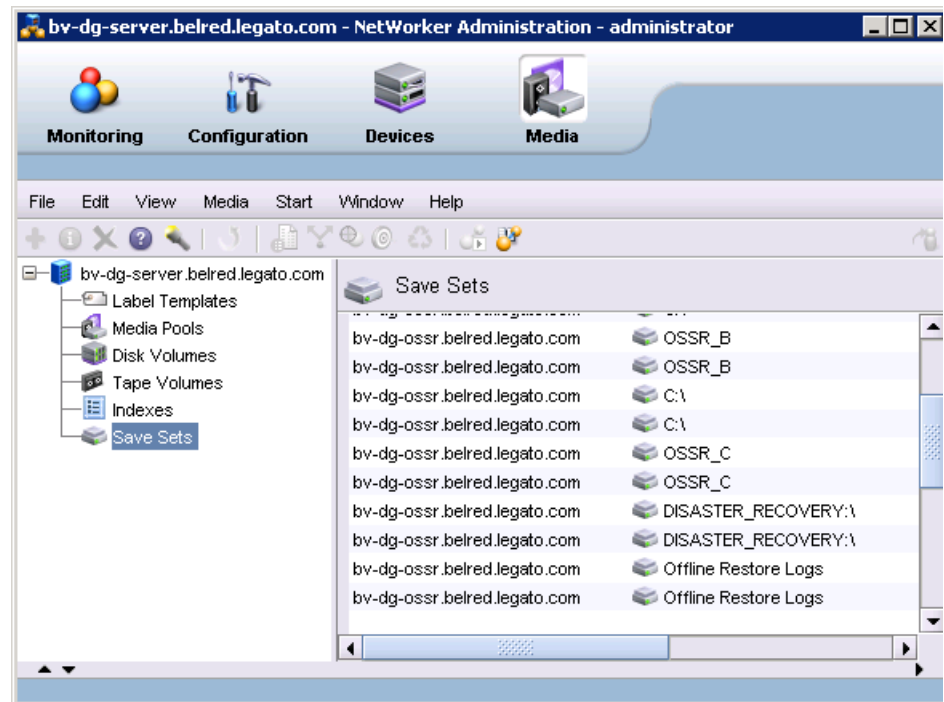

Figure 45 Viewing DISASTER_RECOVERY:\ save sets

The following volumes are considered critical and are included in the disaster recovery backup:

- ◆ Any volume that contains operating system files or files needed by an installed service.
- ◆ A non-critical volume that has a critical volume mounted on it, or a non-critical volume that serves as a parent to a critical volume. This default behavior is user configurable, [“Save Operations attributes for Windows Disaster Recovery” on page 641](#) provides more information.
- ◆ All volumes on all dynamic disks if at least one of those volumes is critical. For example, supposed you have 4 hardware disks in a RAID 5 configuration, and you partition the 4 volume RAID set into 3 partitions as seen by the operating system. If you then installed a service like the NetWorker client's `nsrexecd` program on one of those partitions, then that partition would become critical, as would the whole 4 volume set. This behavior is user configurable, [“Save Operations attributes for Windows Disaster Recovery” on page 641](#) provides more information.

The following files are not backed up on critical volumes:

- ◆ Files listed in the FilesNotToBackup registry key
- ◆ Files excluded by system writers
- ◆ Files that are backed up by a VSS application writer such as Exchange databases. These files must be backed up with a backup module application such as NetWorker Module for Microsoft Applications (NMM).

The following table provides some examples of how critical and non-critical data is handled in backup and recovery operations associated with the DISASTER_RECOVERY:\ save set.

Table 108 Critical and non-critical data

Volume type	DISASTER_RECOVERY:\ backup examples	DISASTER_RECOVERY:\ restore examples
Critical	<p>Boot Configuration Data (BCD)</p> <p>BCD is part of the system state. If the BCD directory is on a Reserved System Partition, then that partition is mounted to a drive letter and backed up.</p> <p>C:\</p> <p>All System State data.</p> <p>Data <i>not</i> backed up by an application VSS Writer.</p>	<p>The system state files for BCD and C:\ are restored along with any files <i>not</i> associated with an application VSS Writer. Files associated with an application VSS Writer are not restored.</p>
	<p><drive_letter>:\</p> <p>Files associated with operating system services installed on the drive (therefore part of the System State).</p> <p>Data <i>not</i> backed up by an application VSS Writer.</p>	<p>Files associated with installed services (system state) are restored along with any files <i>not</i> associated with an application VSS Writer.</p>
	<p>Note: Files that are associated with application VSS Writers are not backed up as part of the DISASTER_RECOVERY:\ save set and therefore, cannot be not restored unless they were backed up by an application backup program such as NMSQL, NME, or NMM. These application backup programs are designed to backup applications such SQL Server, Exchange, and others.</p>	
non-critical	No data is backed as part of the DISASTER_RECOVERY:\ backup.	No data is recovered as part of a Windows Disaster Recovery operation.

Full versus incremental backups with the All save set

The DISASTER_RECOVERY:\ save set is backed up only during Full level backups. During incremental level backups, all other specified save sets are backed up. The typical size of a backup that is created with the All save set may increase significantly for Windows 2008 / 2008 R2 and Windows 7. This is because some user data on critical volumes is backed up twice: once in the DISASTER_RECOVERY:\ save set and once for regular file system backup of local and mapped drives.

To reduce the size of the All save sets that are created during full level backups, consider using Avamar or Data Domain deduplication technology with NetWorker. For more information about deduplication backups with NetWorker clients, refer to the *EMC NetWorker Avamar Integration Guide* or the *EMC NetWorker Data Domain Deduplication Devices Integration Guide*.

Note: When the save set All is attempted for the first time on a system before a DISASTER_RECOVERY:\ save set has been saved, the save level will be forced to Full so that a DISASTER_RECOVERY:\ backup is assured.

Online recovery of VSS system state data

For the purposes of an online recovery, VSS system state data cannot be recovered from the DISASTER_RECOVERY:\ save set. An online recovery of VSS system state data may be required in special cases such as the recovery of specific writers for Active Directory or Windows Server Failover Cluster. To protect these Windows hosts, you can specify the following VSS save sets in a backup client resource:

- ◆ VSS SYSTEM BOOT
- ◆ VSS SYSTEM SERVICES
- ◆ VSS SYSTEM FILESET

Alternatively, you can disable the backup of the special DISASTER_RECOVERY:\ save set and instead, backup the regular VSS save sets by adding the VSS:DISASTER_RECOVERY=off keyword to the Save Operations attribute of the NetWorker client resource. When this keyword is set to off and the All save set is specified, the following VSS save sets will be available for online restore operations:

- ◆ VSS SYSTEM BOOT
- ◆ VSS SYSTEM SERVICES
- ◆ VSS SYSTEM FILESET
- ◆ VSS OTHER
- ◆ VSS USER DATA

For more information, see [“Windows Disaster Recovery backups”](#) on page 613.

Windows Disaster Recovery limitations and considerations

This sections includes the following Windows Disaster Recovery limitations and special considerations to be aware of before performing disaster recovery backup and recovery operations.

- ◆ “Regular backups” on page 606
- ◆ “Capturing disk configuration changes for Windows Disaster Recovery” on page 606
- ◆ “Full backups are required for Windows Disaster Recovery” on page 606
- ◆ “Use deduplication if possible” on page 607
- ◆ “Windows Disaster Recovery is not available for online recovery” on page 607
- ◆ “Mixing critical and non-critical volumes on a physical disk” on page 607
- ◆ “Cloning disaster recovery save sets” on page 607
- ◆ “Support for NetWorker directives” on page 608
- ◆ “EFI and uEFI systems are not supported” on page 608
- ◆ “Only NTFS file systems are recognized as critical volumes” on page 608
- ◆ “Fat / Fat32 file systems are not recognized as critical volumes” on page 608
- ◆ “VSS save sets and post-offline recovery tasks” on page 608
- ◆ “Protecting Windows Server Roles” on page 609
- ◆ “Protecting Microsoft server applications” on page 610
- ◆ “SQL cluster with NMSQL as backup software” on page 610
- ◆ “VMware considerations” on page 612
- ◆ “Conflict with drive letter X:” on page 612

Regular backups

Ensure that a Full level backup that contains the DISASTER_RECOVERY:\ save set is performed regularly and after any significant change to your Windows operating system.

Capturing disk configuration changes for Windows Disaster Recovery

Windows Disaster Recovery uses the Microsoft ASR Writer to reconstruct a disk configuration during the disaster recovery. ASR is sensitive to the disk numbers and disk configuration on the original host. This disk information is saved during a Windows Disaster Recovery backup and is used when the disk configuration is recovered. After any disk reconfiguration on the protected host, reboot and do a Windows Disaster Recovery backup to ensure that the new disk configuration is captured. Examples of a disk reconfiguration are the adding or removing of a disk or partition on the protected host.

Full backups are required for Windows Disaster Recovery

The DISASTER_RECOVERY:\ save set is backed up only during a Full level backup, The DISASTER_RECOVERY:\ save set is *not* backed up with an incremental backup.

Use deduplication if possible

To reduce the size of the All save sets that are created during full level backups, consider using Avamar or Data Domain deduplication technology with NetWorker. For more information about deduplication backups with NetWorker clients, refer to the *EMC NetWorker Avamar Integration Guide* or the *EMC NetWorker Data Domain Deduplication Devices Integration Guide* as appropriate.

Windows Disaster Recovery is not available for online recovery

The DISASTER_RECOVERY:\ save set and its corresponding *OSSR_driveletter* save sets are not available for online recovery. A BMR Windows Disaster Recovery must be performed offline.

Mixing critical and non-critical volumes on a physical disk

Windows allows a physical disk to be partitioned into multiple volumes. These volumes can be either critical or non-critical, depending on the data they contain. During a disaster recovery, the ASR writer may recreate partitions and perform formatting of those partitions. In some cases, such as a disk replacement scenario, this could include non-critical partitions as well. If this happens, the data must be recovered with an on-line recovery. [“Task 6: Post-Restore operations” on page 632](#) provides more information.

IMPORTANT

It is recommended that users do not mix critical and non-critical volumes on the same physical disk.

Cloning disaster recovery save sets

Be aware of the following considerations when cloning Windows disaster recovery save sets.

Select DISASTER_RECOVERY:\ and OSSR_driveletter save sets

The disaster recovery backup creates save sets for each critical volume. The critical volume save sets are named *OSSR_driveletter* where *driveletter* is the drive letter. If the critical volume is on a mount point, then the mount point name will also be included in the save set name. For example, if a critical volume is mounted on F:\mnt_point, then the critical volume save set name would be *OSSR_F_mnt_point*.

When specifying a clone job for disaster recovery save sets, be sure to specify the DISASTER_RECOVERY:\ save set and its corresponding *OSSR_driveletter_mnt_point* save sets.

[“Components of the DISASTER_RECOVERY:\ save set” on page 602](#) provides more information on how to view the OSSR save sets that are associated with a DISASTER_RECOVERY:\ save set.

Automatic cloning from a backup group

If you have set up a backup group to automatically clone disaster recovery save sets, ensure that NetWorker server and client host clocks are synchronized across the network. Otherwise, some or all of the save sets may not be cloned.

Support for NetWorker directives

The following list explains how the three types of NetWorker directives are handled during a Windows Disaster Recovery backup.

- ◆ Global directives — All NetWorker global directives are ignored except for the AES encryption directive.
- ◆ NetWorker User local directives — All such directives are ignored.
- ◆ Local directive files — All such directives are ignored.

[Chapter 6, "Directives"](#) provides more information on directives.

EFI and uEFI systems are not supported

Systems with Extensible Firmware Interface (EFI) or Universal Extensible Firmware Interface (uEFI) are not supported for Windows DR backup and recovery.

Only NTFS file systems are recognized as critical volumes

Only critical volumes on NTFS partitions are supported for Windows Disaster Recovery. This is a Microsoft ASR limitation. If a critical volume is on a non-NTFS partition, the DISASTER_RECOVERY:\ will fail with the error message:

```
Disaster Recovery: Critical volume contains non-NTFS drives, but
cannot be included in the savesets
```

This message is logged in the savegrp.log file. To remedy the situation, find the service or application that is installed on a non-NTFS volume, remove it, and reinstall it on a NTFS volume.

Fat / Fat32 file systems are not recognized as critical volumes

Fat/Fat32 file systems are not supported by Windows Disaster Recovery as critical volumes.

VSS save sets and post-offline recovery tasks

Although VSS system state writers are recovered during a Windows Disaster Recovery operation, they cannot be selected explicitly during a NetWorker Windows Disaster Recovery operation. If you want the option to recover just the following writers, you must select them for recovery in an online recovery operation. NetWorker supports online recovery of the following VSS writers:

- ◆ Active directory
- ◆ Distributed File System Replication (DFS-R)
- ◆ Windows Server Failover Cluster

To recover the above writers online, you must backup the following VSS SYSTEM STATE save sets separately from the DISASTER_RECOVERY save set. Also, ensure that the following VSS system state writers are backed up and recovered together:

- ◆ VSS SYSTEM BOOT
- ◆ VSS SYSTEM SERVICES
- ◆ VSS SYSTEM FILESET

For information about including VSS system state save sets in a back up, see [“Windows Disaster Recovery backups” on page 613](#). To recover VSS save sets, see [“Task 6: Post-Restore operations” on page 632](#).

Active Directory considerations

Windows Disaster Recovery of a Domain Controller is non-authoritative by default. If you need to perform an authoritative restore, you must boot into DSRM mode directly from the NetWorker disaster recovery wizard. [“Post-Restore operations for Active Directory” on page 634](#) provides more information.

DFS-R considerations

The Replication folder will be saved with the DISASTER_RECOVERY:\ save set only if the folder resides on a critical volume. If the replication folder resides on a non-critical volume that is included in a backup, it can be recovered online after a Windows Disaster Recovery.

Protecting Windows Server Roles

Several server role components of Windows Server 2008 and 2008 R2 need a database for their data storage. Examples of Windows server roles with databases include:

- ◆ Active Directory Rights Management Services (ADRMS)
- ◆ Windows System Resource Manager (WSRM)
- ◆ Universal Description, Discovery, and Integrations (UDDI) Services
- ◆ Windows Server Update Services (WSUS)

When these Windows server roles are installed, you can select either an existing SQL Server installation or the Windows Internal Database (WID). WID is a variant of SQL Server Express 2005 and is a feature component of Windows Server 2008. The Volume Shadow Copy Service (VSS) SQL Server Writer is used to protect the WID databases.

NetWorker Windows Disaster Recovery protects role databases stored in WID but does not protect role databases stored in a SQL Server outside of WID.

If system state data, such as roles, are stored in a SQL Server database outside of WID, then the data must be protected by using NetWorker Module for Microsoft Applications (NMM), NetWorker Module for SQL (NMSQL), or a third party SQL backup product. SQL server system databases (master, model, and msdb) are not restored as part of NetWorker Windows Disaster Recovery. To perform a SQL Server disaster recovery, you must:

- ◆ Perform a SQL Server disaster recovery to rebuild the SQL system databases.
- ◆ Use the SQL application backup tool such as NMM to restore all the SQL databases as required.

Backup and recovery workflow for server roles that use WID

Use NetWorker Windows DR to save and restore the WID database.

1. Perform a NetWorker Windows Disaster Recovery backup. All SQL Writer components for WID will be included in the backup.
2. Perform a NetWorker Windows Disaster Recovery operation. All WID components are restored.

After the NetWorker Windows Disaster Recovery system reboot, the WID service is available and Windows server roles have access to their databases.

Backup and recovery workflow for server roles that use SQL Server

Use NMM, NMSQL, or a third-party application to restore SQL Server components.

1. Protect the host system state and user data with the NetWorker Windows client.
2. Protect the SQL Server application with NMM, NMSQL, or a third party application.
3. Perform a NetWorker Windows Disaster Recovery operation.
After the disaster recovery reboot, the system is restored but the SQL Server service will not run. Any roles with databases in the SQL Server will not work.
4. Perform a SQL Server disaster recovery. Refer to the following Microsoft URL
<http://msdn.microsoft.com/en-us/library/ms189302.aspx>
5. Restore the SQL system databases (master, model, msdb) with NMM, NMSQL, or a third party application.
6. Restore the role databases with NMM, NMSQL, or a third party application.
7. Restart the services that require the restored role databases.

Protecting Microsoft server applications

Microsoft server application hosts such as a Microsoft Exchange Server, Microsoft SQL Server, Microsoft Data Protection Manager (DPM), Hyper-V, or Microsoft Office SharePoint Service, should be protected with both a NetWorker module and the regular NetWorker client. The NetWorker module will protect the application data such as databases and log files. The regular NetWorker client will protect the host's critical disks for the purposes of bare metal recovery.

The workflow of a complete disaster recovery operation is:

- ◆ Back up critical and non-critical disks as part of your regular NetWorker file system backups.
- ◆ Back up applications such as Microsoft SQL Server by using a NetWorker module such as the NetWorker Module for Microsoft Applications (NMM) or the NetWorker Module for SQL (NMSQL).
- ◆ Perform a Windows DR of the host's critical volumes.
- ◆ Recover any non-critical disks using the NetWorker User Program or if NMM is being used, the NMM recovery interface. If NMM is being used, refer to the NMM documentation for details.
- ◆ Recover application data using a NetWorker module such as NMM.

For more information about recovering application data, refer to the documentation that comes with your NetWorker module software.

SQL cluster with NMSQL as backup software

If you are using the NetWorker Module for Microsoft SQL Server (NMSQL) to protect a SQL server that is hosted in a Microsoft cluster, there are special considerations to aware of in order to use NetWorker Windows Disaster Recovery. This section provides an example and the steps to follow in order to use NetWorker Windows Disaster Recovery with a clustered Microsoft SQL server that is protected with NMSQL.

Example 47 Protecting a clustered SQL server with NMSQL and Windows Disaster Recovery

This example assumes the following conditions:

- ◆ Microsoft SQL Server 2008 R2 is hosted on a Microsoft Failover Cluster on Windows 2008 SP2.
- ◆ NMSQL 5.2 SP2 is used to protect the SQL server.
- ◆ **Node & File share Majority** is the quorum setting.
- ◆ Cluster node A has SQL installed in C:\Program Files\Microsoft SQL Server.
- ◆ Cluster node B has SQL installed in C:\Program Files\Microsoft SQL Server.
- ◆ Shared disks that include the SQL databases can be accessed by node A and B.

To protect the clustered SQL server in this example:

1. Install the NetWorker7.6 SP2 client and NMSQL 5.2 SP2 on both nodes A and B.
2. Perform an instance level backup of the virtual SQL server using NMSQL. Refer to the *NetWorker Module for Microsoft Server Administration Guide* for details.
3. Perform a Windows Disaster Recovery backup for Node A. "[Windows Disaster Recovery backups](#)" on page 613 provides more information.
4. Perform a Windows Disaster Recovery backup for Node B.

To recover a clustered SQL server in this example:

1. Perform a Windows Disaster Recovery operation on Node A first and then on Node B. "[Windows Disaster Recovery operations](#)" on page 618 provides more information.

The Microsoft Failover Cluster should be up and running.

Note: If the host is a virtual machine, first create a new virtual machine with the same configuration as before the disaster, and then perform the Windows Disaster Recovery operation.

2. Export the required shared disks. Ensure that the disks have the same properties as the original ones, and that the disks are shared between node A and node B.
3. From the Cluster Management interface, delete any disk entries that are listed as failed disks.
4. Add the newly exported shared disks to the SQL group and assign the same drive letters as before the disaster.
5. On node A, rebuild the SQL server by running the following **Setup** command. The **Setup** command is located in the SQL Server installation media and must be executed from the command prompt. The command prompt must be run with Windows Administrator privileges. Before running this command, ensure that the SQL group is offline except for the shared disks.

```
Setup /QUIET /ACTION=REBUILDDATABASE /INSTANCENAME=Instance_name
/SQLSYSADMINACCOUNTS=domain_name\administrator
```

The system databases will be generated on the new shared disk. For more information on rebuilding SQL Server:

- SQL Server 2005
msdn.microsoft.com/en-us/library/ms144259%28v=sql.90%29.aspx
- SQL Server 2008
msdn.microsoft.com/en-us/library/dd207003.aspx

6. After the SQL server is rebuilt, bring the SQL group online.
7. Try to create a new database.
If the new database is not successfully created, check the disk dependencies on the SQL Server resource and correct them if necessary.
8. Open the NMSQL interface on Node A and recover the backed up database.

VMware considerations

This section contains Windows Disaster Recovery limitations that are specific to VMware virtual machines.

Network card driver limitations

The Windows Disaster Recovery image does not contain a driver for any of the VMware VMXNET network interface card (NIC) models. However, the Windows Disaster Recovery image does contain a driver for the e1000 NIC. If you have at least one e1000 NIC configured for the virtual machine, you can perform the disaster recovery. Alternatively, you can add custom NIC drivers when running the Windows Disaster Recovery wizard.

Conflict with drive letter X:

The drive letter X: is used by the WinPE image as the system drive. This creates a conflict with any critical volume that uses the drive letter X:. If a critical volume uses the drive letter X:, the disaster recovery backup will fail with error message:

```
Disaster Recovery: X drive is detected as a critical volume but cannot  
be included in the savesets.
```

This message is logged in the savegrp.log file. To remedy the situation, do the following:

- ◆ Move any service installed on X: to another drive.
- ◆ Ensure that no critical volumes are mounted on the X: drive.
- ◆ Perform a new DR backup.

Windows Disaster Recovery backups

Windows DR backups can be run on a scheduled basis (full level backups only) or manually (on demand). This section describes how to plan and set up Windows DR backups.

Back up planning

[Table 109](#) lists the save sets to backup depending on the Windows host that you are protecting.

Table 109 Identifying which save sets to back up

To back up this	Specify these save sets in the client resource Save Set attribute	Considerations
A regular Windows 2008 / 2008 R2 or Windows 7 desktop host or file server.	Specify the save set All . By default, the save set All includes: <ul style="list-style-type: none"> the DISASTER_RECOVERY:\ save set All local, physical drives 	
A Windows 2008 / 2008 R2 host so that the following items can be recovered online, that is, without requiring an offline Windows DR operation: <ul style="list-style-type: none"> Active Directory Windows Server Failover Cluster DFS-R <p>Note: The items listed above are recovered with the DISASTER_RECOVERY:\ save set during an offline DR operation. However, to recover these items online, the VSS SYSTEM save sets must be explicitly specified in the client's Save Set attribute.</p>	<ul style="list-style-type: none"> Save set All VSS SYSTEM BOOT:\ VSS SYSTEM SERVICES:\ VSS SYSTEM FILESET:\ <p>The save set All cannot be listed with other save sets. To backup a host using the All save set and the VSS SYSTEM save sets:</p> <ol style="list-style-type: none"> Create two NetWorker client resources for the host. Specify the save set All in one resource and specify the VSS SYSTEM save sets in the other resource. Ensure that each client group is included in a separate backup group. <p>“Putting disaster recovery backups on a different schedule” on page 642 provides an example of setting up two client resources for the same host.</p>	
A Windows 2008 / 2008 R2 host with server roles that use a SQL Server database	<ul style="list-style-type: none"> Use the NetWorker client and specify the All save set. Use an application backup product such as NMM or NMSQL to back up the SQL Server databases. Refer to the application backup product's documentation for details. 	<ol style="list-style-type: none"> Recover the host's system state with NetWorker Windows Disaster Recovery. Recover the application databases with NMM or NMSQL.
A Windows 2008 / 2008 R2 host with Microsoft server applications such as a Microsoft Exchange Server, Microsoft SQL Server, Microsoft Data Protection Manager (DPM), or Microsoft Office SharePoint Service	<ul style="list-style-type: none"> Use the NetWorker client and specify the All save set. Use an application backup product such as NMM or NMSQL to back up the application databases. Refer to the application backup product documentation for details. 	<ol style="list-style-type: none"> Recover the host's system state with NetWorker Windows Disaster Recovery. Recover the application databases with NMM, NMSQL, or a third party application.

How to include Windows DR in scheduled backups

Although you can back up the DISASTER_RECOVERY:\ save set separately, the easiest way to schedule Windows DR backups is to specify the save set All. Specifying the save set All, ensures that all system state data and user data can be recovered in the event of a disaster.

To set up a Windows 2008 / 2008 R2 or Windows 7 client for scheduled Windows DR backups, you can use either the NetWorker Client Configuration wizard or the NetWorker Client properties window.

Configure backups with the Client wizard

To configure a client with the NetWorker Client Configuration wizard:

1. In the NMC **Enterprise** view, select the NetWorker server name, and double-click the **NetWorker** managed application to launch it.
2. In the **Configuration** view, under the NetWorker server name, right-click **Clients** and select **Client Backup Configuration > New**. Alternatively, if you are modifying an existing client, right-click the client name and select **Client Backup Configuration > Modify**.
3. Follow the instructions on the wizard pages.

On the Select Files to Back Up page, it is recommended that you select all files for backup. This is the default selection.

- By default, the option **Perform disaster recovery for this client** is selected. Un-selecting this option will exclude the DISASTER_RECOVERY:\ save set from being backed up, and the VSS SYSTEM save sets will be generated instead.
- If you are protecting a system that also hosts Active Directory, DFS-R, or Windows Server Failover Cluster, and you want to have the option to recover these items online, that is, without performing a disaster recovery, create an additional client resource for the host and specify the following save sets:

VSS SYSTEM BOOT:\

VSS SYSTEM SERVICES:\

VSS SYSTEM FILESET:\

If you do not specify the previously listed save sets explicitly, Active Directory, DFS-R, or Windows Server Failover Cluster applications are still recovered with the DISASTER_RECOVERY:\ save set. However, the DISASTER_RECOVERY:\ save set can only be recovered with an offline recovery (Windows DR) operation.

4. Complete the wizard screens as instructed.

Configure backups with the Client properties window

To configure a client with the Client properties window:

1. In the NMC **Enterprise** view, select the NetWorker server name and double-click the NetWorker application to launch it.
2. In the **NetWorker Administration** window, click **Configuration**.

3. In the browser tree, select **Clients**:
 - To create a new Client resource, select the **Clients** icon and from the **File** menu, click **New**.
 - To edit an existing client resource, select the client name from the list in the right panel and from the **File** menu, select **Properties**.
4. In the **Name** attribute, type the hostname for the client and, optionally, type a comment in the **Comment** attribute.
5. Select values for **Browse Policy** and **Retention Policy**:
 - The browse policy determines how long the details of individual backed-up files are maintained in a browsable index for quick recovery through the GUI or command line.
 - The retention policy determines how long backed-up data is protected and available for recovery even though the browse policy has lapsed. Recovery might require rebuilding an index.
6. Select the **Scheduled Backups** checkbox.
7. In the **Save Sets** attribute,
 - In the Save Set attribute for the Client resource, type **All**. Alternatively, you can type **DISASTER_RECOVERY:** to create a back up for disaster recovery purposes only.
 - If you are protecting a system that also hosts Active Directory, DFS-R, or Windows Server Failover Cluster, and you want to have the option to recover these items online, that is, without performing a disaster recovery, create an additional client resource for the host and specify the following save sets:
 VSS SYSTEM BOOT:
 VSS SYSTEM SERVICES:
 VSS SYSTEM FILESET:
 If you do not specify the previously listed save sets explicitly, Active Directory, DFS-R, or Windows Server Failover Cluster applications are still recovered with the **DISASTER_RECOVERY:** save set. However, the **DISASTER_RECOVERY:** save set can only be recovered with an offline recovery (Windows DR) operation.
8. In the **Group** attribute, select a backup group. Ensure that you do not select a Snapshot group.
9. In the **Pool** attribute, select a pool that targets the NetWorker devices you want to use. The pool selected in this attribute overrides any other pool that might be configured for the client or its save sets.

Note: For pre-NetWorker 7.6 SP1 clients, this setting should *not* be used.

10. In the **Schedule** attribute, select a backup schedule.
 The schedule selected in this attribute overrides any other schedules that might be configured for the client or its save sets.
11. When you have completed the client configuration, click **OK**.
 In the **NetWorker Administration** window, the configured client shows a checkmark in the **Scheduled backup** column to indicate that scheduled backup is enabled.

Chapter 2, “Backing Up Data” provides more information about setting up a scheduled backup.

How to include Windows Disaster Recovery in manual backups

Backing up data by selecting *Computer* is the preferred method of performing manual Windows Disaster Recovery backups. This method ensures that all data is backed up.

To perform a disaster recovery backup manually:

- ◆ In the NetWorker User program, click the **Backup** button and select **Computer** to save all data.
- ◆ At a minimum, select the DISASTER_RECOVERY:\ save set.
- ◆ If you are protecting a system that also hosts Active Directory, DFS-R, or Windows Server Failover Cluster, you can also select the following save sets so that they will be available for online recovery.
 - VSS SYSTEM BOOT:
 - VSS SYSTEM SERVICES:
 - VSS SYSTEM FILESET:

Chapter 2, “Backing Up Data” provides more information about manual backups.

How to verify that a valid disaster recovery backup exists

After you perform a Windows DR backup, verify that the backup exists. The save sets that make up the DISASTER_RECOVERY:\ save set correspond to each critical volume and are named as *OSSR_driveletter*, for example if drives C and D were identified as critical drives, they would be listed as *OSSR_C* and *OSSR_D*.

You can verify that the backup exists by checking the NMC Console, the NetWorker User program, or by using the **nsrinfo** program.

To verify that a valid disaster recovery exists by using the NMC Console:

1. In the NMC **Enterprise** view, select the NetWorker server name and double-click the NetWorker application to launch it.
2. In the **NetWorker Administration** window, click **Media**.
3. In the left pane, click **Save Sets**.
4. In the **Save Set Query** tab in the right pane, specify search criteria such as the NetWorker **Client Name** and a date range for the **Save Time**.

5. Select the **Save Set List** tab in the right pane to display a list of save sets that meet the search criteria.

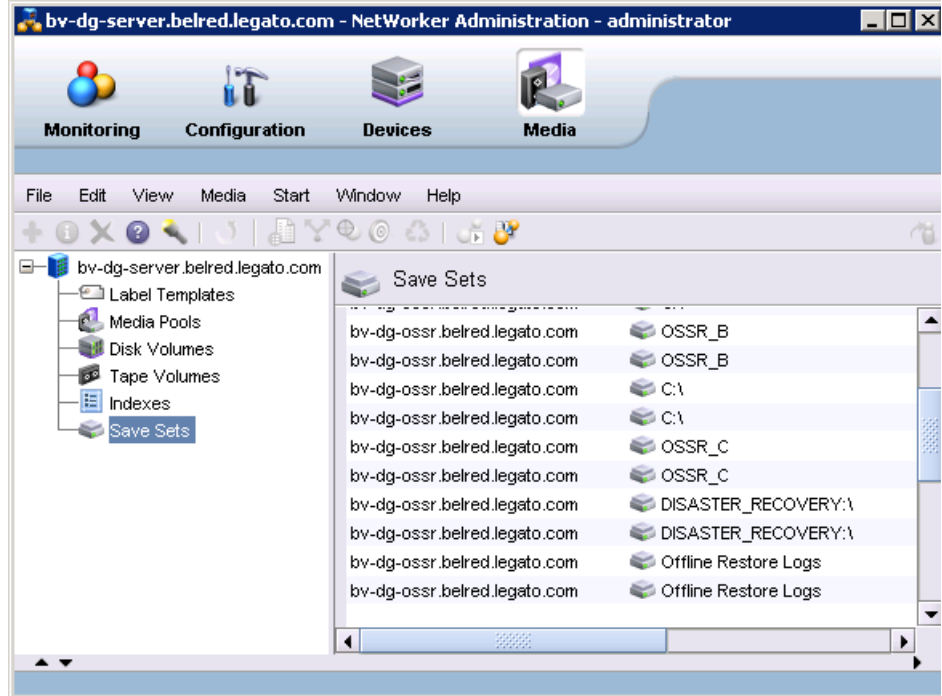

Figure 46 Viewing **DISASTER_RECOVERY:** save sets in NMC

To verify that a valid disaster recovery save set exists by using the NetWorker User Program:

1. Start the NetWorker User program by using the **-s** option to connect to the NetWorker server to which the source client data is backed up:

```
winworkr -s servername
```

If the **-s** option is not entered and there is only one server detected, that server will be connected to automatically. If there are no servers detected, or if there is more than one server available, the **Change Server** dialog box appears, allowing you to choose the server.

2. Click **Recover** to open the **Source Client** dialog box.
3. Select the client whose disaster recovery save set you are verifying and click **OK**.
4. Select a destination client and click **OK**.
5. In the **Recover** window, browse and locate the save set named, **DISASTER_RECOVERY:**.

By default, the most recent backup is listed. You may have to adjust the browse time if you are verifying older files. You can adjust the browse time by selecting the **View > Change Browse Time** menu option.

To verify that a valid disaster recovery save set exists by using the **nsrinfo** program:

- ◆ Type the following command at a command prompt:

```
nsrinfo -v -s <server> -N "DISASTER_RECOVERY:\  
<client>
```

where:

- *<server>* is the name of the NetWorker server
- *<client>* is the name of the client that performed the disaster recover backup.

This command must be run on a host that has the NetWorker 7.6 SP2 client. Earlier versions of **nsrinfo** are not capable of displaying information about disaster recover backups.

Windows Disaster Recovery operations

This section describes how to use the NetWorker Windows Disaster Recovery image to perform a bare metal disaster recovery on protected hosts.

Before you ever need to perform a bare metal recovery on a host, you must have, at a minimum, backed up the DISASTER_RECOVERY:\ save set for that host and have completed the following tasks in this section:

- ◆ [“Task 1: Create the NetWorker Windows Disaster Recovery bootable media” on page 618](#)
- ◆ [“Task 2: Prerequisites” on page 620](#)
- ◆ [“Task 3: Gather information” on page 620](#)
- ◆ [“Task 4: Test the wizard” on page 621](#)

This section also includes the following topics to help you complete a Windows DR operation:

- ◆ [“Task 5: Run the wizard” on page 621](#)
- ◆ [“Task 6: Post-Restore operations” on page 632](#)
- ◆ [“Troubleshooting Windows Disaster Recovery” on page 636](#)
- ◆ [“Additional recover options” on page 640](#)

Task 1: Create the NetWorker Windows Disaster Recovery bootable media

NetWorker provides a Windows Disaster Recovery image that you can use to create a bootable CD or network boot location. To begin the recovery process, you will boot the Windows 2008 / 2008 R2 or Windows 7 host from the bootable CD or network location. The disaster recovery will start a NetWorker System Recovery wizard that will guide you through the disaster recovery process.

Be aware that although only a 32 bit version of the NetWorker Windows Disaster Recovery image is provided, this image restores 64 bit hosts as well.

Obtaining the disaster recovery image

To download the disaster recovery boot image:

1. Go to the following location Powerlink:

Home > Support > Software Downloads and Licensing > Downloads J-O > NetWorker

2. Select the link for the custom Windows Disaster Recovery image named **NetWorkerWindowsDisasterRecovery_7.6.2-638_x86.iso**.

The download process will begin.

Creating a disaster recovery boot CD

To create a bootable CD:

1. Open your CD creation software and select an option to burn an ISO image.
2. Browse to the location of the downloaded NetWorker Windows Disaster Recovery image and complete the steps required to create a bootable CD with the image.

Enabling a host to boot from a CD

To ensure that the protected host can boot from a CD:

1. Start the host and enter the BIOS set up program. Typically, you press **F2** to enter the BIOS set up program.

Note: If you are restoring a virtual host such as a VMware virtual machine, you can set up options such as the host boot location from within vSphere. Refer to your VMware documentation for specific steps.

2. Select the boot options menu and ensure that the CD boot option is at the top of the list of locations from which to boot.
3. Save your changes and exit the BIOS program.

Creating a disaster recovery network boot location

The following prerequisites must be met to use the network boot option:

- ◆ The NetWorker clients that you are protecting must be enabled to boot from the network with a Pre-Boot Execution Environment (PXE).
- ◆ A Deployment Services server must be configured and available.
- ◆ The NetWorker Windows System Recover boot image must be added to the Deployment Services server so that a client host on the network can boot from it.

For example, the following link provides details on how to configure Windows Deployment Server in Windows Server 2008:

[http://technet.microsoft.com/en-us/library/cc771670\(ws.10\).aspx](http://technet.microsoft.com/en-us/library/cc771670(ws.10).aspx)

Enabling a host to boot from the network

To enable a host to boot from the network (PXE enabled):

1. Start the host and enter the BIOS set up program. Typically, you press **F2** to enter the BIOS set up program.

Note: If you are restoring a virtual host such as a VMware virtual machine, you can set up options such as the host boot location from within vSphere. Refer to your VMware documentation for specific steps.

2. Select the BIOS options necessary so that the network boot option is enabled. If need be, refer to your BIOS documentation.
3. Save your changes and exit the BIOS program.

Your host should obtain an IP address from your WDS server and prompt you if you want to do a network boot. Typically, a network boot is activated by pressing the F12 key.

Task 2: Prerequisites

The following prerequisites must be met to successfully perform a recovery with the NetWorker Windows Disaster Recovery image:

- ◆ The hardware on the host to be recovered (target) is operational.
- ◆ The hardware configuration on the target host is similar to the hardware configuration on the host for which the Windows Disaster Recovery backup was done (source). Any hardware, driver, or firmware differences between the source and target computers may cause the disaster recovery to fail. For example, recovering a 64-bit host to a 32-bit host is not supported.
- ◆ The target host requires a minimum of 512 MB of RAM.
- ◆ The target host disks must be at least the same size as the source host disks.
- ◆ There are at least as many disks on the target host as there were on the source host. The disk LUN numbering on the target host must match the disk LUN numbering on the source host.
- ◆ The disaster recovery boot image is available from the host's CD volume or from the network boot location.
- ◆ Although the disaster recovery boot image comes with a large number of NIC and storage device drivers, it may be necessary to load a NIC or storage device driver while running the wizard. Any required NIC or storage adapter drivers must be 32-bit versions and they must not require a reboot to complete the driver installation process.

Note: It is strongly recommended that a 64 bit host that requires special drivers be tested by booting the NetWorker disaster recovery image and loading the 32 bit version of the special drivers by using the wizard. After verifying that the drivers can be detected by the wizard, you can safely exit the wizard before completing the entire recovery process and reboot to the normal operating system.

Task 3: Gather information

Ensure that you have the following before starting the Windows DR wizard:

- ◆ Network or disk drivers that may need to be installed.
- ◆ The IP address and network name of the host that is being restored.
- ◆ The network name or IP address of the NetWorker server that will be used to restore the host.
- ◆ If a DNS server is being used to resolve IP addresses, you need to know the default gateway and the name of the DNS server. If a DNS server is not available, you can use a local hosts file to resolve the NetWorker server name or IP address.
- ◆ The NetWorker media volumes that are required for the disaster recovery are available. [“Viewing the volumes required for data recovery” on page 324](#) provides information about using the NetWorker User program to obtain a list of required volumes.

Task 4: Test the wizard

Before you need to perform a Windows Disaster Recovery, test the wizard to ensure that you can run it and that you have the required drivers. This task is especially important for 64 bit hosts that may require additional drivers to complete the wizard. For both 64 bit and 32 bit hosts, the wizard must use 32 bit drivers that do not require a reboot.

After you test the wizard, you can safely exit the wizard before completing the entire recovery process.

To test the wizard:

1. Complete steps 1 to 10 in [“Task 5: Run the wizard”](#) on page 621.

Verify the following as you step through the wizard screens:

- If DNS is not available, the host can resolve the NetWorker server name by some method such as a local hosts file.
 - You can see the network interface that is required to communicate with the NetWorker server. If you cannot see the network interface, use the wizard to load the required NIC driver.
 - You can see the critical and non-critical disks for the host that is to be recovered. If you cannot see all of the disks, use the wizard to load the required disk drivers.
2. Click **Exit** to safely exit the wizard
 3. Exit the command window.

The system will automatically reboot.

Task 5: Run the wizard

To perform a disaster recovery with the wizard:

Note: If DNS is not available, you can manually add and edit a hosts file to add information about the NetWorker server. Details are provided in the following steps.

1. Boot the host to be restored from the location of the NetWorker Windows Disaster Recovery image, either a CD or network boot location.

Refer to [“Creating a disaster recovery boot CD”](#) on page 619 or [“Creating a disaster recovery network boot location”](#) on page 619 as necessary.

2. Click **Next** when the Welcome screen of NetWorker System Recovery wizard appears.

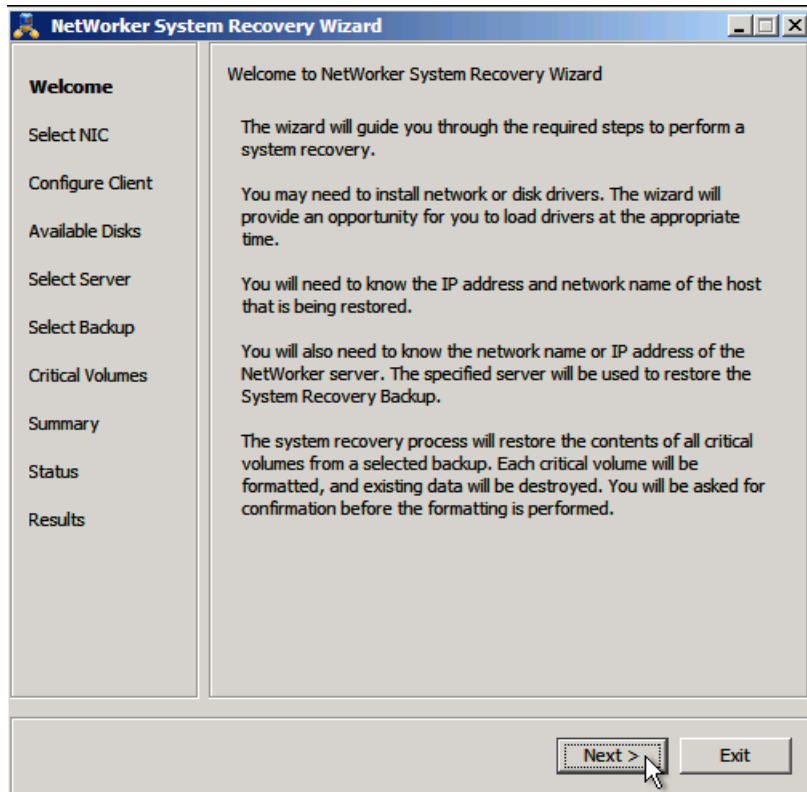

Figure 47 NetWorker System Recovery Wizard Welcome screen

3. Perform this step only if a DNS server is not available on the network. If DNS is not available, you can manually add and edit a hosts file to add information about the NetWorker server.
 - a. Exit the Disaster Recovery Wizard but do not reboot the host.
You will be returned to the WinPE command line.
 - b. Edit the hosts file (for example `X:\Windows\System32\Drivers\etc\hosts`) and add the IP address and host name for the NetWorker server and Avamar Deduplication node (if one is being used).
 - c. Restart the wizard from the `X:\Program Files\Legato\nsr\wizard` directory. For example:

```
X:\Program Files\Legato\nsr\wizard> javaw -jar WinPEWizard.jar
```
 - d. When the wizard appears, click **Next** to continue.

4. In the Select Network Interface screen, select the NIC (Network Interface Card) driver so that the host can communicate with the NetWorker server during the restore process.

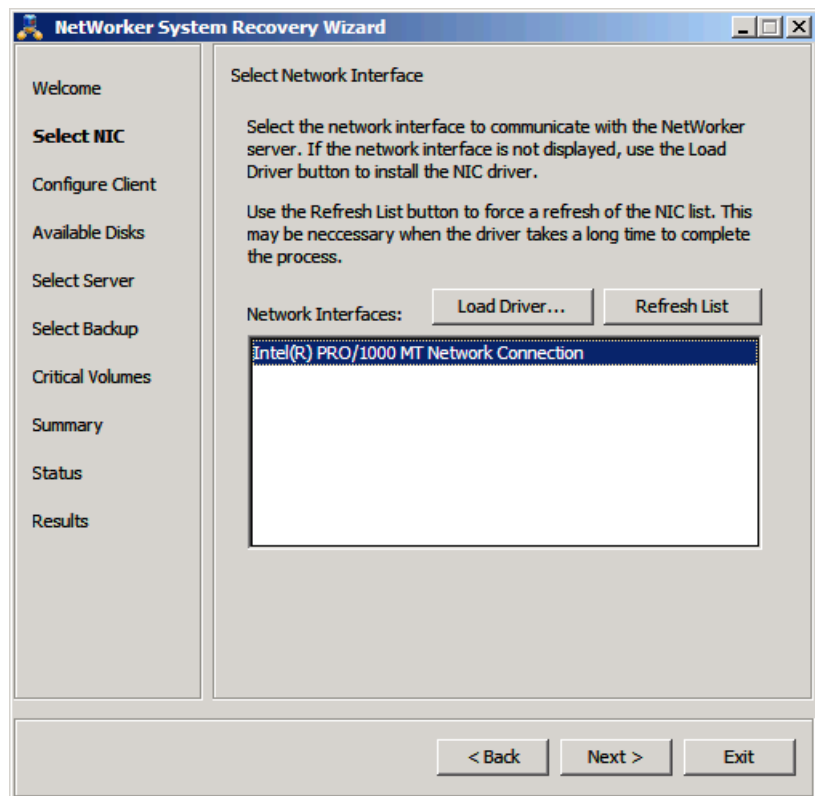

Figure 48 Select Network Interface screen

If the required NIC driver is not in the list, click **Load Driver** to browse to a location such as a CD or USB drive and locate the required driver.

Be aware that the selected driver cannot require a reboot operation. This is because the WinPE environment is loaded in memory only and changes are not persistent across a reboot operation. Also be aware that although some drivers prompt for a reboot operation, most modern NIC drivers are generally plug-and-play and ignoring the reboot prompt may actually work.

5. Click **Next** to display the Hostname and Network screen.

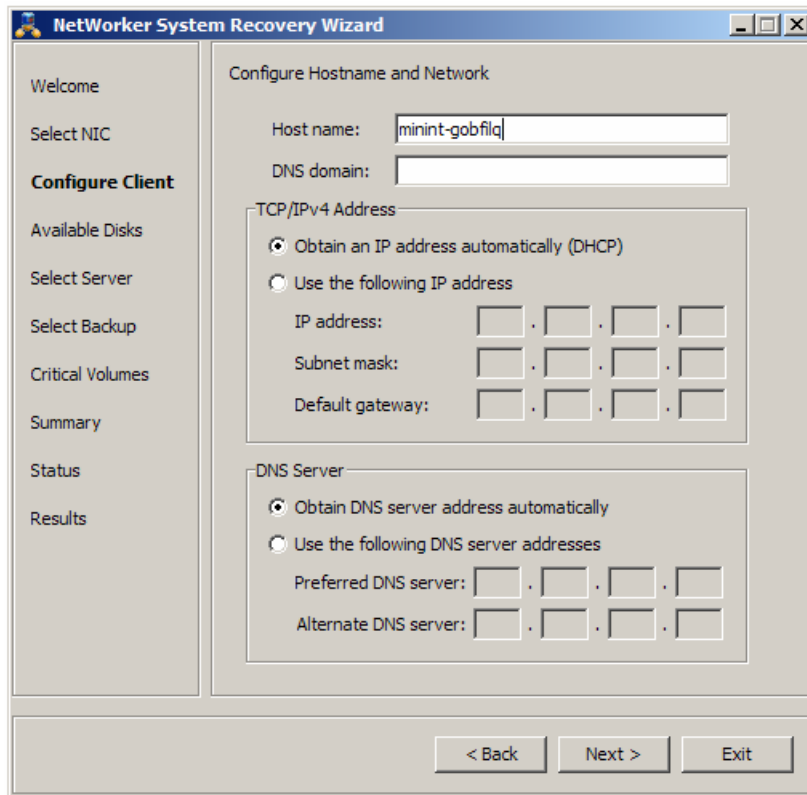

Figure 49 Configure Hostname and Network screen

- a. Enter the host name of the machine that you are recovering in the **Host name** field.
 - b. Enter the name of the domain in which the host resides in the **DNS domain** field. If the host resides in a workgroup instead of a domain, this field can be left blank.
 - c. In the TCP/IP Address fields, select **Obtain an IP address automatically (DHCP)** if host IP addresses are assigned automatically. If the IP address of the host to be restored is static, enter the IP address in the **IP address** field. If applicable, enter the subnet mask and the default gateway used by the host to be restored in the **Subnet mask** and **Default gateway** fields.
 - d. In the DNS Server fields, select **Obtain DNS server address automatically** if the DNS server name is automatically assigned. If the DNS server IP address is static, enter the IP address of the DNS server in the **Preferred DNS server** field. If applicable, enter an alternate DNS server address in the **Alternate DNS server** field.

You can ignore the DNS Server fields, if you added the NetWorker server host name and IP address to the X:\Windows\System32\Drivers\etc\hosts file in [step 3](#) earlier.
 - e. Click **Next**.
6. All local disks that have been detected are displayed in the Available Disks screen. If the wizard has failed to detect a disk, click **Load Driver** to browse to a location such as a CD or USB drive, and locate the correct driver for the disk. After loading the required disk driver, click **Refresh** to update the list of disks

that have been detected.

....

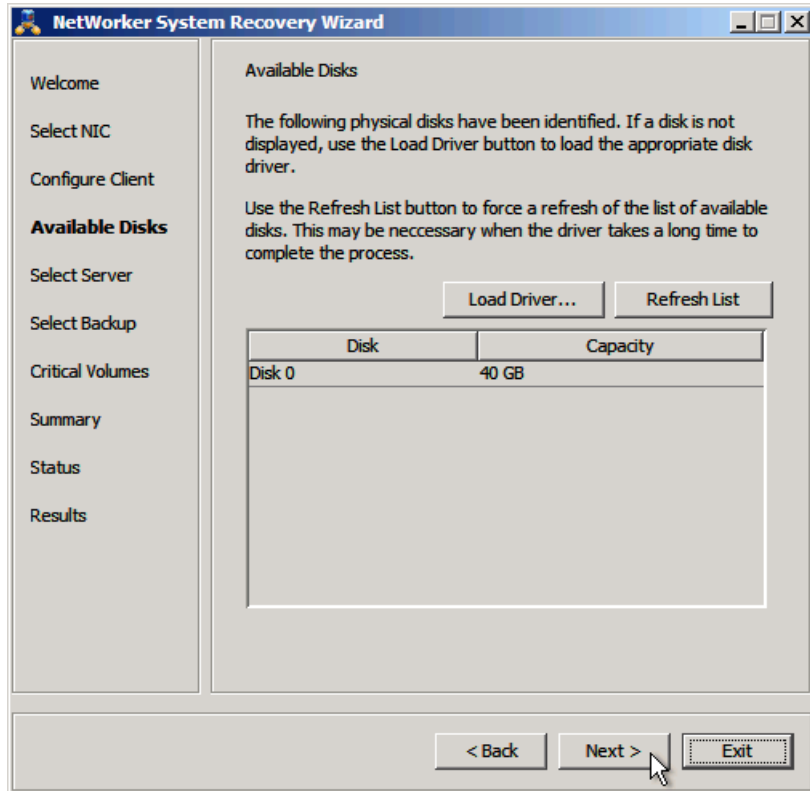

7. Click Next.

8. In the Select NetWorker Server screen, select the NetWorker server to which the host was backed up.

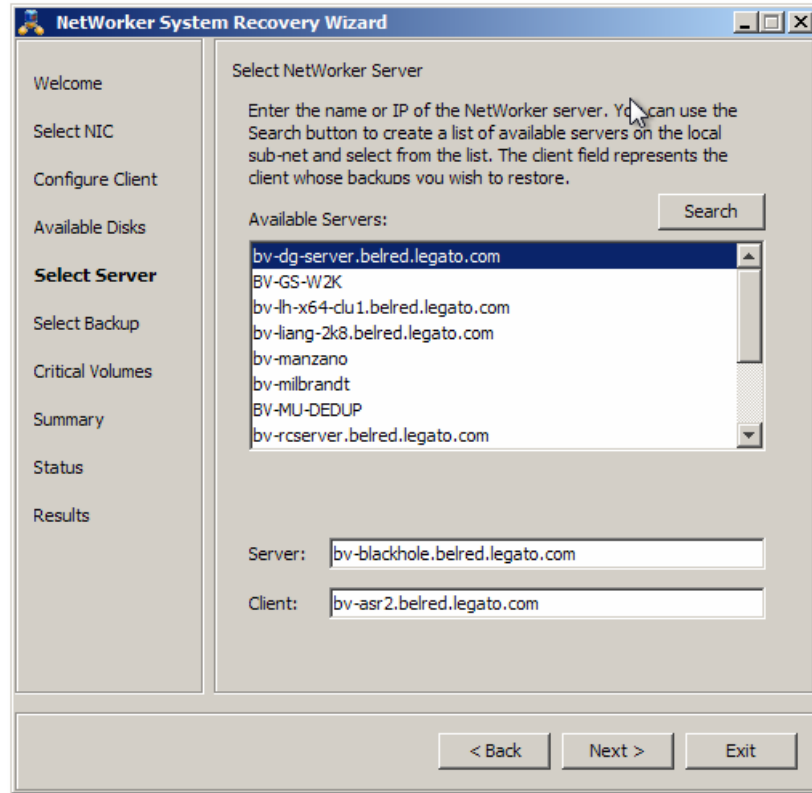

Figure 50 Select NetWorker Server

- Double-click on the appropriate NetWorker server from the list or type the fully qualified domain name (FQDN) in the **Server** field. You have to click **Search** to update the list of NetWorker servers. The Search function will locate only those NetWorker servers on the local subnet.
- In the **Client** field, make sure the client name matches the client resource name on the NetWorker server. For example, if the client resource on the NetWorker server uses a FQDN, then use the client's FQDN in the Client field.

This field is automatically populated with the values that were typed in the Host name and DNS Domain fields on the Configure Client screen of the wizard.

You can modify the **Client** field if you want to restore a backup that was created by a different machine. However, the hardware configuration of the target machine must be similar to the original machine. [“Task 2: Prerequisites” on page 620](#) provides more information. You must also satisfy the following requirements for performing a directed recover:

- The NetWorker server must have a client resource for both the source machine and the target machine.
- The **Remote Access** attribute of the client resource for the source machine must allow access to the user / host machine that is performing the directed recovery operation. Do this by adding "SYSTEM@target_client" to the source client resource's **Remote Access** attribute.

- Add "**user=system,host=target_client**" to the **Users** attribute of the NetWorker server's preconfigured Administrators user group.

Note: If a different client (target) is specified, the restored machine will use the same hostname and IP settings as the source machine. This can cause hostname and IP address conflicts if the source machine is running on the same network.

- c. Click **Next**.
9. Select the System backup that you wish to restore to the host in the Select System Recovery screen. System backups are listed in descending order from most recent to oldest. Click **Next**.

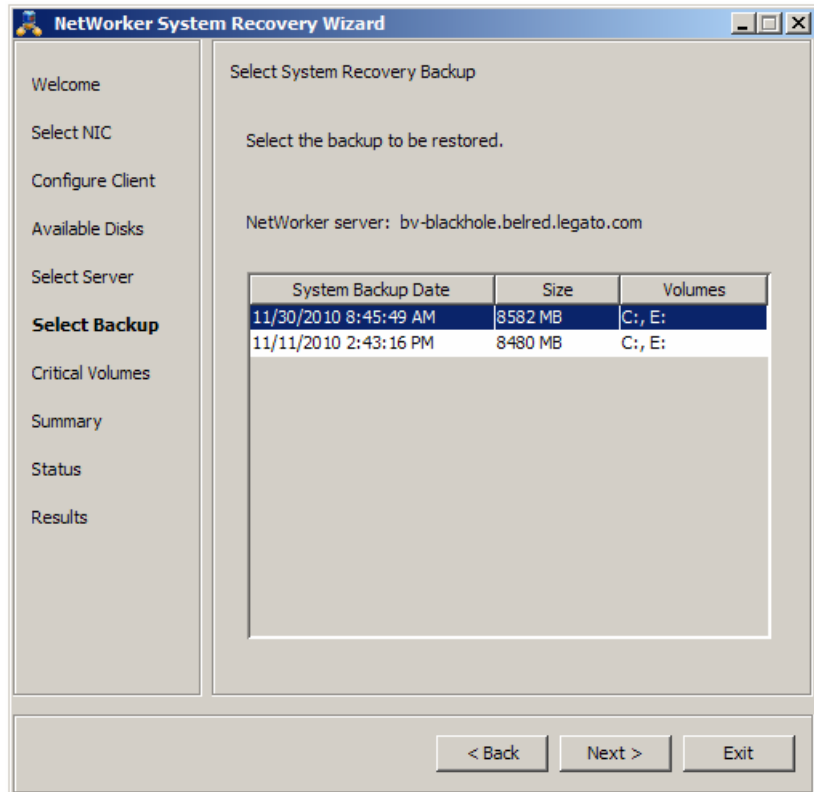

Figure 51 Select System Recovery Backup

10. The Critical Volumes to Restore screen lists the volumes that will be restored to the host.

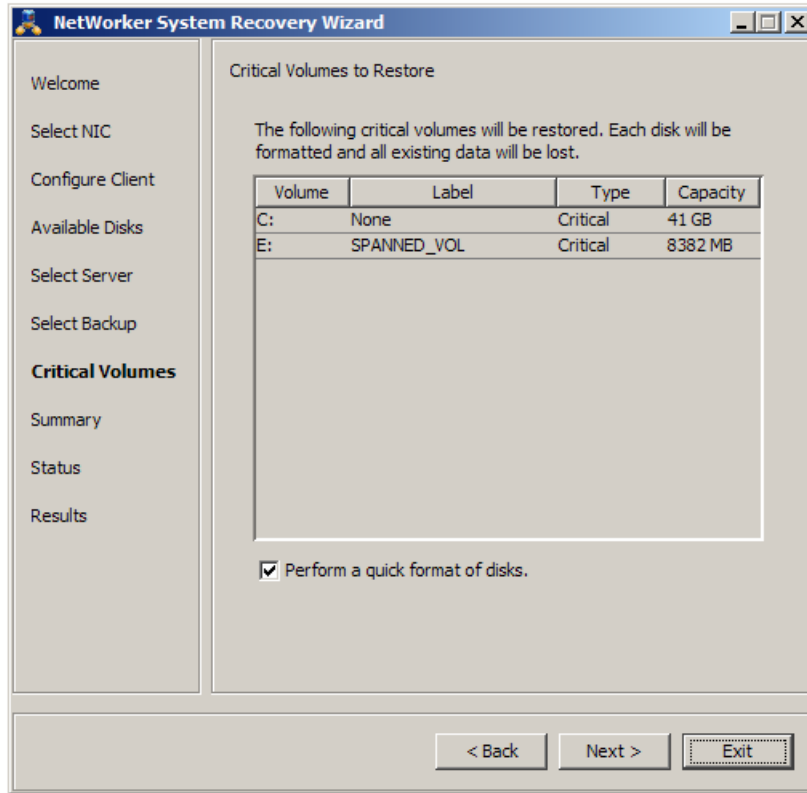

Figure 52 Critical Volumes to Restore

During the restore process, critical volumes will be reformatted. Non-critical volumes will be formatted only if the disk signature is different, for instance if the disk was replaced.

To perform a “quick format” instead of a full format operation, ensure that **Perform a quick format of disks** is selected. This is the default selection. Although quick formatting is much faster than full formatting, a quick format, unlike a full format, does not verify each sector on the volume.

The restore process will not recover non-critical volume data even if the non-critical volume is reformatted. Non-critical volumes can be recovered, if necessary, by using the NetWorker User program after the wizard has completed and the host has been rebooted.

11. Click **Next**.

12. The System Recovery Summary screen lists the selected restore options.

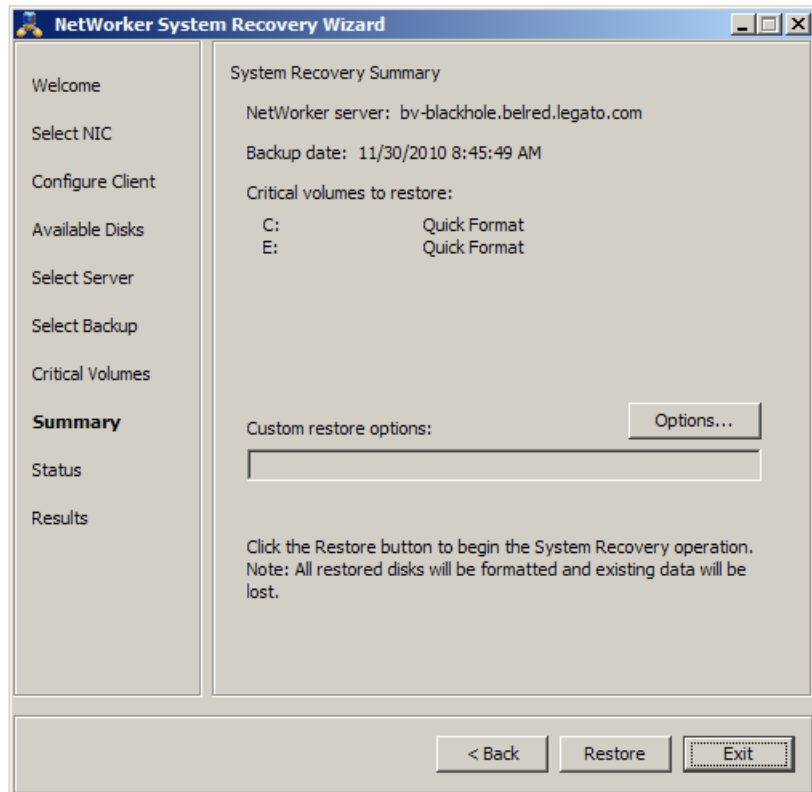

Figure 53 System Recovery Summary

If you need to specify any non-default restore options, click **Options** to display the Non-Default Recover Options screen.

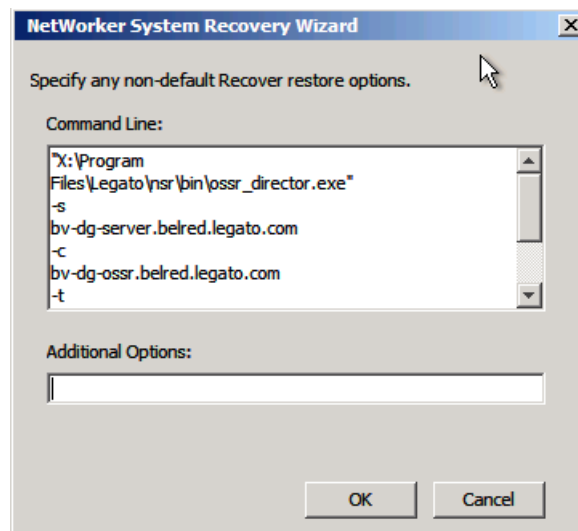

Figure 54 Non-Default Recover Options

- a. Type any required non-default options with their corresponding values in the **Additional Options** field. Non-default options are primarily used for troubleshooting purposes. [“Additional recover options” on page 640](#) provides more information.
 - b. Click **OK** to save and close the Non-Default Recover Options screen and return to the summary screen.
13. Click **Restore** to begin the restore process.

A confirmation screen will display. Confirm your choice to begin the restore process and then click **OK**.

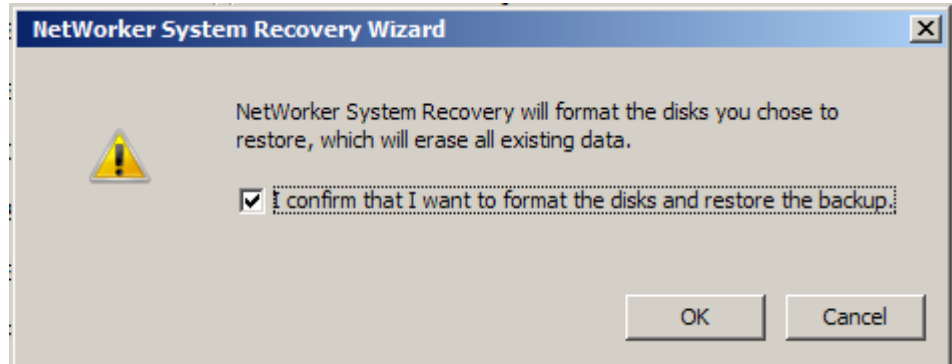

Figure 55 Confirmation screen



IMPORTANT

Be aware that all data will be lost on volumes that are being reformatted.

At the end of the disaster recovery process, log files are backed up to the NetWorker server. These files can be used to troubleshoot a failed disaster recovery. Ensure that the NetWorker server has a mounted writable back up volume available for these log files. Otherwise, the disaster recovery will not complete because it is waiting for a writable volume. If this occurs, you can cancel the log file backup without affecting the disaster recover operation. By default, disaster recovery log files are written to the default backup pool. If desired, you can set up a special backup pool for log files. To do so, ensure that the backup pool accepts manual save sets that are named **Offline Restore Logs**. [“Recovering and viewing Windows DR log files” on page 637](#) provides more information about accessing log files.

The following screen is displayed when the restore process has completed.

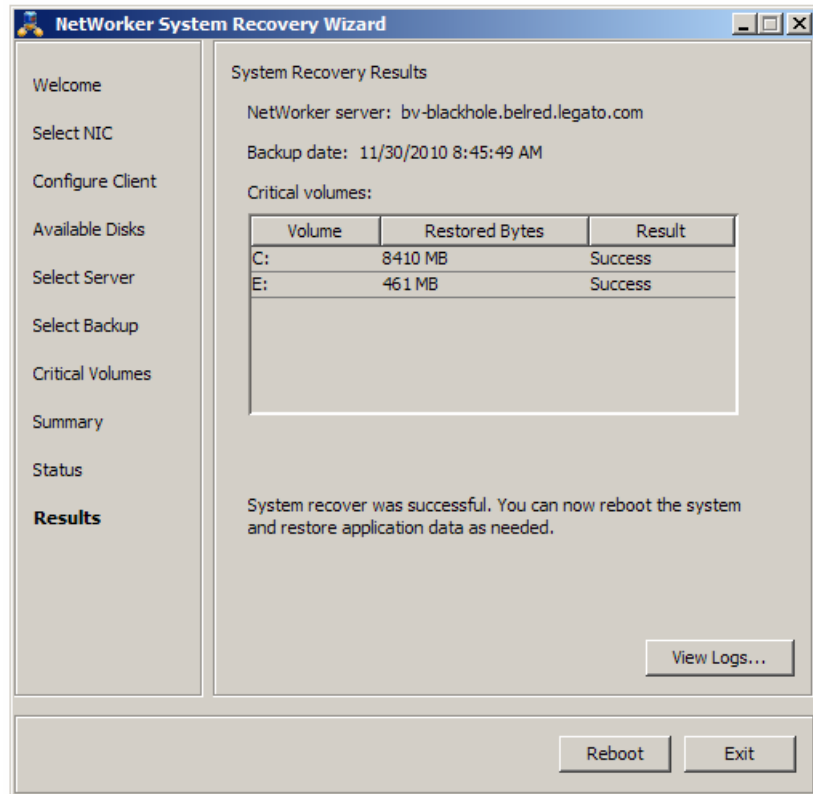

Figure 56 Offline System Recovery Results

14. Before selecting **Reboot**, consider the following:

If you are recovering an Active Directory domain controller, it will be recovered in non-authoritative mode by default. If you need to recover the domain controller in authoritative mode, do not select Reboot. Instead, select **Exit** to return to the WinPE command prompt and boot into Directory Services Restore Mode (DSRM). [“Post-Restore operations for Active Directory” on page 634](#) provides more information.

Next steps

Be aware of the following considerations before moving to [“Task 6: Post-Restore operations” on page 632](#).

- ◆ After the disaster recovery has completed and the system is rebooted, check the host’s disk and volume configuration. It is likely that all disks and volumes appear as they did on the original system. However, it is possible, if disk signatures do not match the original disks, that non-critical disks may be off-line or not mounted. In this case, you may need to use Microsoft Disk Manager to bring online or mount the disks. After the disks are online, a reboot operation should result in disk drive letter re-assignments. However if it does not, assign drive letters to non-critical disks as needed. Non-critical volumes that are accessed by mount points may have similar issues.
- ◆ To completely restore the host, you may have to perform additional online recovery steps using the regular NetWorker User program. [“Task 6: Post-Restore operations” on page 632](#) provides more information. Recovering files on non-critical volumes is one example of a post-restore operation.

- ◆ If a folder has been encrypted in Windows, for example by selecting **Folder Properties > Advanced > Encrypt contents to secure data**, it will be recovered as encrypted. However, the encryption attribute will not be set on the folder. You can manually reset the encryption attribute after the disaster recovery operation. This is a Microsoft limitation.
- ◆ Windows Disaster Recovery can backup critical volumes that are BitLocker encrypted. However, the recovered volumes will not be encrypted. You can use the BitLocker icon in the Control Panel to re-apply the volume encryption. This is a Microsoft limitation.

Task 6: Post-Restore operations

This task explains how to recover data that was not recovered as part of the Windows Disaster Recovery operation. The following topics are covered:

- ◆ [“Post-Restore operations when using the NetWorker Module for Microsoft Applications \(NMM\)” on page 632](#)
- ◆ [“Post-Restore operations when using an application backup tool other than NMM” on page 632](#)
- ◆ [“File system and VSS system data” on page 632](#)
- ◆ [“Post-Restore operations for Active Directory” on page 634](#)
- ◆ [“Post-Restore operations for hosts with server roles that use SQL Server” on page 635](#)
- ◆ [“Post-Restore operations for a Microsoft Hyper-V virtual machine” on page 635](#)

Post-Restore operations when using the NetWorker Module for Microsoft Applications (NMM)

If the recovered host was protected with the NetWorker Module for Microsoft Applications product (NMM), all post-restore operations must be performed by using the NMM client interface. Do not complete any post-restore operations in this chapter. Refer to the NMM documentation for post-restore operations.

Post-Restore operations when using an application backup tool other than NMM

If you have backed up a database application with an application backup tool other than NMM, perform the following post-restore operations:

- ◆ Recover any required file system or VSS system data by completing the steps in [“File system and VSS system data” on page 632](#).
- ◆ Recover the application data using the application backup tool. Examples of such tools include the NetWorker Module for SQL Server (NMSQL), NetWorker Module for Exchange Server (NME), or any third-party application backup tool. Refer to the documentation that comes with your application backup tool.

File system and VSS system data

Perform an online recovery of user data or VSS system data if any of the following conditions apply:

- User data on non-critical volumes needs to be recovered, for instance when disk hardware was replaced due to a disaster prior to the Windows DR operation.

- VSS system data needs to be recovered. Although the VSS system data for the following items is recovered in a Windows Disaster Recovery operation, you can recover more recent VSS system state backups if they are available. Additionally, you can restore the following items at any time by performing an online recovery operation.
 - Active Directory
 - DFS-R
 - Windows Server Failover Cluster
- [“Back up planning” on page 613](#) provides more information about backing up VSS system data so that it is available for an online recovery. If VSS system data has been backed up, you can restore the previously listed services at any time with an online recovery operation.

To perform an online recovery:

1. Manually remount any non-critical volumes as needed.
2. Start the NetWorker User program by using the **-s** option to connect to the NetWorker server to which the source client data is backed up:

```
winworkr -s servername
```

If the **-s** option is not entered and there is only one server detected, that server will be connected to automatically. If there are no servers detected, or if there is more than one server available, the **Change Server** dialog box appears, allowing you to choose the server.

3. Click **Recover** to open the **Source Client** dialog box.
4. Select the source client and click **OK**.
5. Select the destination client for the recovered data, and click **OK**.
6. In the **Recover** window, select the files to recover.
7. Click **Start** to begin the directed recovery.
 - [Chapter 13, “Recovering Data”](#) provides more information about recovery options.
 - The NetWorker Disaster recovery Guide provides more information about an Active Directory online recovery and Windows Server Failover Cluster online recovery.
 - [Appendix C, “Backing Up and Restoring a Microsoft DFS”](#) provides more information about a DFS-R online recovery.

Post-Restore operations for Active Directory

The offline restore of the DISASTER_RECOVERY:\ save set in the case of a domain controller, is non-authoritative. If a non-authoritative restore is desired, then no post-restore operations are required. However, if you need to perform an authoritative restore, follow these steps.

To perform an authoritative restore:

1. From the last screen of the wizard, titled System Recovery Results, do not select Reboot. Instead, select **Exit** to exit the wizard so that you can boot into Directory Services Restore Mode (DSRM). Failure to boot into DSRM mode will result in a non-authoritative restore. If this occurs, run the Windows Disaster Recovery again and ensure that you boot into DSRM mode.

- a. Exit the wizard to prevent an automatic reboot.

The WinPE command prompt appears.

- b. From the command prompt, use the following **bcdedit** commands to add a boot loader entry to force the system to boot into DSRM:

```
X:\> bcdedit /copy {default} /d "Directory Service Repair Mode"
```

Enter the command exactly as shown above.

A message similar to the following appears:

```
The entry was successfully copied to
{00000000-0000-0000-0000-000000000000}
```

The numbers in the previous message, are a Globally Unique Identifier (GUID) that identifies a new entry. In this example, the GUID is a string of zeros and is for illustration purposes only. The actual GUID that is generated when you run the command will be unique.

- c. Using the generated GUID, enter the following command to set the safeboot option for the boot loader entry in the Boot Configuration Data (BCD) store.

```
X:\> bcdedit /set {GUID_value} safeboot dsrepair
```

Where {*GUID_value*} is the GUID displayed by the previous **bcdedit** command.

- d. Exit the command prompt to reboot the system.

Failure to boot into DSRM will result in a non-authoritative restore.

2. (Optional) If you have VSS system state save set backups and they are more recent than the DISASTER_RECOVERY:\ save set, you can recover them in DSRM using the NetWorker User program.
3. Run the Windows **ntdsutil** command-line utility.

The **ntdsutil** prompt appears. The **ntdsutil** utility is a command interface similar to the NetWorker **recover** interface. For help in the **ntdsutil** utility, type ? at the **ntdsutil** prompt.

4. At the **ntdsutil** prompt, type:

```
NTDSUTIL: activate instance ntds
```

```
NTDSUTIL: authoritative restore
```

5. To perform an authoritative restore of a subtree or individual object, type:

```
NTDSUTIL: restore subtree "distinguished_name"
```

For example,

```
NTDSUTIL: restore subtree
"OU=engineering,DC=Seattle,DC=jupiter,DC=com"
NTDSUTIL: restore subtree
"CN=mars,CN=users,DC=Seattle,DC=jupiter,DC=com"
```

The Microsoft Windows Server Resource Kit documentation on AD provides information.

6. Exit the **ntdsutil** utility by typing **quit** at each successive **ntdsutil** prompt until the command-prompt appears.
7. Type the following command at the command prompt so that the host does not boot into DSRM mode upon reboot.

```
C:\> bcdedit /deletevalue safeboot
```

8. Restart the domain controller in normal mode and then log in and verify that the authoritative changes are replicated to the AD replication partners.

Post-Restore operations for hosts with server roles that use SQL Server

1. After performing a NetWorker Windows Disaster Recovery, perform a SQL Server disaster recovery. Refer to the article located at the following Microsoft URL for guidance on a SQL Server disaster recovery. However, be aware that this article provides general guidelines only. There is no need to re-install the operating system, as mentioned in the article, if you performed a NetWorker Windows Disaster Recovery. The NetWorker Windows Disaster Recovery re-installs the operating system automatically.

<http://msdn.microsoft.com/en-us/library/ms189302.aspx>

2. Restore the SQL system databases (master, model, msdb) with NMM, NMSQL, or a third party application.
3. Restore the role databases with NMM, NMSQL, or a third party application.
4. Restart the services that require the restored role databases.

Post-Restore operations for a Microsoft Hyper-V virtual machine

A recovery of a Hyper-V parent partition by the Windows Disaster Recovery operation does not recover the file, InitialStore.xml. Without this file, the Hyper-V Machine Management Service (VMMS) will not start properly and a third-party restore of the Hyper-V application may fail.

To recover the Hyper-V application, you must:

- ◆ Create a new InitialStore.xml file.
- ◆ Start the VMMS service.
- ◆ Restore the Hyper-V configuration, including the InitialStore.xml file and all virtual machines.
- ◆ Restart the VMMS service.

Note: Do not connect the Hyper-V Manager to the restored machine's local Hyper-V server before recovering the Hyper-V configuration.

To create a new InitialStore.xml file:

1. On the recovered Hyper-V host, click **Start > Run**, type **MMC** in the Run dialog, and press **Enter**.

A default Microsoft Management Console (MMC) shell appears.

2. Add the Authorization Manager so that it can be selected from the File menu:

- a. From the **File** menu, select **Add/Remove Snap-In**.
- b. Select **Authorization Manager** and then click **Add**.

3. Switch to Developer Mode by right-clicking **Authorization Manager** and then selecting **Options > Developer Mode**.

4. Create the new **InitialStore.xml** file.

- From the Action menu, select **New Authorization Store**, and place the XML file in the Hyper-V installation location. The standard installation path is:

```
c:\programdata\microsoft\windows\hyper-v
```

Ensure that the XML file is named **initialstore.xml**.

5. Create a new Application named *exactly* **Hyper-V services** by right-clicking the InitialStore.xml file and specifying the Application Name of **Hyper-V services**.

6. Create a new role named **Administrator**:

- a. Under **Hyper-V services**, add a role definition named **Administrator**.
- b. Right-click **Role Assignments** and add **Administrator**.

7. Add the **Administrators** group to this role. Alternatively, you can add the **Local System Administrators** or **Domain Administrators** group to this role.

- Right-click **Administrator** and select **Assign Users And Groups** and then complete the steps to add the **Administrators** group.

8. Start the VMMS service.

You should now be able to recover the Hyper-V configuration, including the backed up InitialStore.xml file and all virtual machines.

9. After the recovery of the Hyper-V application including the InitialStore.xml file that was backed up, restart VMMS.

Note: If you started Hyper-V Manager and connected to the restored machine's local Hyper-V server before recovering the Hyper-V configuration, then the Hyper-V Manager may display a message about an inability to access the local Hyper-V server. To resolve this issue, go to the Hyper-V Manager and remove the local Hyper-V server and then reconnect to it.

Troubleshooting Windows Disaster Recovery

The following topics provide information to help troubleshoot Windows Disaster Recovery operations.

- ◆ [“Recovering and viewing Windows DR log files” on page 637](#)
- ◆ [“Wizard cannot locate the NetWorker server or DNS server” on page 638](#)
- ◆ [“Network configuration values may not be retained after reboot” on page 639](#)
- ◆ [“SAN boot devices” on page 639](#)
- ◆ [“Virtual Machines using VMware drivers” on page 639](#)

Recovering and viewing Windows DR log files

To help troubleshoot unsuccessful disaster recoveries, the following log files are generated and backed up during the Windows DR operation:

- ◆ **Ossr_director.raw** — Contains the recovery workflow of the DISASTER_RECOVERY:\ metadata save set and the critical volume (*OSSR_volume_name*) save sets. This log also contains any errors related to recovering the metadata files or ASR writer errors.
- ◆ **recover.log** — Contains output from the NetWorker **recover.exe** program. This information is generated during the recovery of each save set. This log also contains messages about errors related to critical volume data recovery.
- ◆ **WinPE_Wizard.log** — Contains information about the work flow related to the NetWorker System Recovery wizard user interface.
- ◆ **winpe_nw_support.raw** — Contains output from the **winpe_nw_support.dll**. The output provides information about the communication between the NetWorker System Recovery wizard and the NetWorker server.

If the Windows Disaster Recovery fails, you can recover the log files by using FTP (File Transfer Protocol) on the recover host or by using a directed recovery. If the Windows Disaster Recovery was successful, you can recover the log files directly to the recovered host.

To view log files, you can use either a text editor or the **nsr_render** program, depending on the log file format.

Accessing the log files

To access the log files by using FTP:

1. Access the WinPE command line on the recover host.

You may have to exit the Disaster Recovery Wizard to access the WinPE command line. If you exit the wizard, do not reboot.

2. Disable the Windows firewall. For example:

```
X:\Program Files\Legato\nsr\wizard>wpeutil DisableFirewall
```

By default the Windows firewall is enabled on WinPE and this blocks the FTP port from transferring files.

3. Move to the following directory that contains the log files:

```
X:\Program Files\legato\nsr\logs
```

4. Use the FTP utility to move the log files to another NetWorker host.

To access the log files by using a directed recover operation:

1. Start the NetWorker User program by using the **-s** option to connect to the NetWorker server to which the source client data is backed up:

```
winworkr -s servername
```

If the **-s** option is not entered and there is only one server detected, that server will be connected to automatically. If there are no servers detected, or if there is more than one server available, the **Change Server** dialog box appears, allowing you to choose the server.

2. Click **Recover** to open the **Source Client** dialog box.
3. Select the source client, which is the client that was being restored, and click **OK**.
4. Select the destination client for the recovered data, and click **OK**.

5. From the Options menu, select **Options** and specify a folder location in which to relocate the recovered log files and click **OK**.
6. In the **Recover** window, select the log files to recover.

The log files are typically located in the following directory:

```
X:\Program Files\legato\nsr\logs
```

Note: By default the Windows Disaster Recovery WinPE image is set to Pacific Standard Time (PST). You may temporarily be unable to browse and recover the Offline Restore Logs save set if your local time is earlier than PST time. For example, if your local time is PST plus two hours, then the Offline Restore Log save set would not be available for recovery by browsing until the two hours have elapsed.

7. Click **Start** to begin the directed recovery.

[Chapter 13, "Recovering Data."](#) provides more information about the permissions required for directed recoveries.

Viewing the log files

To view the log files:

- ◆ The following log files can be viewed with a text editor:
 - recover.log
 - WinPE_Wizard.log
- ◆ The following log files can be viewed with the **nsr_render** program:

- Ossr_director.raw
- winpe_nw_support.raw

For example, type the following command at a command prompt to display Ossr_director.raw file:

```
nsr_render_log "C:\logs\Client-bv1\Ossr_director.raw"
```

To direct the Ossr_director.raw file to a text file that can be viewed in a text editor, type the following:

```
nsr_render_log "C:\logs\Client-bv1\Ossr_director.raw" > mylog.txt
```

Wizard cannot locate the NetWorker server or DNS server

If the NetWorker System Recovery Wizard cannot locate the NetWorker server or the DNS server (if one is being used), try the following:

- ◆ If you are using a local hosts file instead of a DNS server, verify that the host name and IP address of the NetWorker server and Avamar Deduplication node (if one is being used) was entered correctly.
- ◆ If you are using a DNS server, verify that the values entered in the Configure Hostname and Networker screen, were entered correctly.
- ◆ Verify that the NetWorker server was correctly specified in the Select NetWorker Server screen.

To verify host name and IP address values, use the ping utility that is included in the WinPE environment:

1. Exit the Disaster Recovery Wizard but do not reboot the host.

You will be returned to the WinPE command line.

2. Use the ping utility to locate and verify host names and IP addresses. For example:

```
X:\Program Files\Legato\nsr\wizard>ping -a hostname
```

3. Restart the wizard. For example:

```
X:\Program Files\Legato\nsr\wizard> javaw -jar WinPEWizard.jar
```

Note: After the wizard has been restarted, you can switch between the wizard and the WinPE command line without exiting the wizard.

Multiple NICs and errors locating the NetWorker server

An error message similar to the following may display when trying to recover a host with multiple NICs:

```
Error retrieving the list of Networker servers
```

This is an indication that the NIC selected by the wizard is not the NIC that was connected to the NetWorker server when the backup was made and may not have connectivity to the server. This applies when searching for an available server or specifying a specific server. To resolve the issue, select one of the other NICs.

Network configuration values may not be retained after reboot

In some cases, a host does not retain its network configuration data after a Windows Disaster Recovery and after the host boots. If the recovered host is experiencing network connectivity issues, confirm that network properties for the local connections are correct. If necessary, manually update the network configuration data on the host.

SAN boot devices

When a system is using a SAN boot device and a disaster recovery must be done, the WinPE environment requires that all but one path to the boot device be temporarily disabled. Once the operating system has been rebooted the remaining paths can be re-enabled.

Virtual Machines using VMware drivers

Recovery of a VMware Windows guest using VMware specific drivers requires special consideration. For example if a guest is built using the VMXNET, VMXNET3 NIC drivers or the VMware Paravirtual SCSI driver, the WinPE environment cannot see the NIC or any hard disks. These drivers must be loaded in the disaster recovery wizard.

The drivers are part of the VMware Tools installation and are located in the `Program Files\VMware\VMware Tools\Drivers` folder on the virtual machine's system drive. Be aware that for the disaster recovery wizard, 32 bit versions of the drivers must be used.

Additional recover options

Additional, non-default, recovery options can be entered on the WinPE command line or in the **Additional Options** field of the Windows Disaster Recovery wizard.

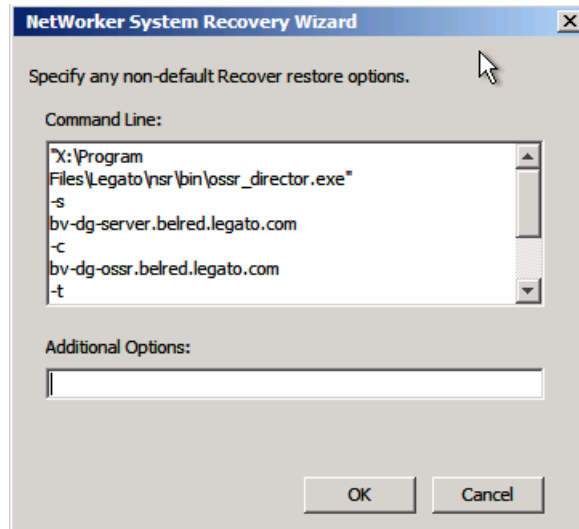

Figure 57 Additional recovery options in the wizard

Table 110 describes the additional recovery options that can be used with a Windows Disaster Recovery Operation.

Table 110 Additional recovery options with

Task	Entry	Result
Show additional debug information in the disaster recovery logs	-D <i>n</i> where <i>n</i> is a number from 1 to 9, with 9 providing the most debug information and 1 providing the least.	More debug information will be included in the Windows Disaster Recovery log files.
Show additional information on the progress of the Windows Disaster Recovery operation.	-v	More information on the progress of the disaster recovery will display in the wizard's System Recovery Status window.
Format non-critical disks to resolve disk mis-match errors.	-p	<p>By default, the Windows DR recovery skips the formatting of non-critical disks. By using the -p option, any existing partitions are deleted and all disks are reformatted on the restored computer to match the layout of the system image. However, by Microsoft specification, even if the -p option is selected, a non-critical volume will not be reformatted if the disk signature has not changed since the backup.</p> <p>This option may be useful in situations where a system fails to restore because of disk mis-match errors. In this case, the -p option may resolve those errors.</p> <p>IMPORTANT</p> <p>The disaster recovery process will not recover non-critical volume data even if the volume is reformatted. Non-critical volumes can be recovered by using the NetWorker User program after the wizard has completed and the host has been rebooted.</p>

Optimizing Disaster Recovery backups

This section provides options and examples that can help you to optimize your Windows Disaster Recovery backups.

Critical volume management recommendations

The following practices will help to minimize the size of your disaster recovery backups.

- ◆ Do not store non-critical data such as MPEG files on critical volumes.
- ◆ Consolidate critical volumes, for example, install services on the same disk.
- ◆ Do not mount critical volumes on a non-critical volume.

Save Operations attributes for Windows Disaster Recovery

Table 111 lists the save operation attributes that can be used with Windows DR backups. These options are specified in the client resource's Save Operations attribute and are typically used to reduce the size and improve the speed of back up operations.

Be aware that by using any of the attributes in Table 111, there is a potential that some data may not be available for recovery. To avoid this situation, follow the important recommendations in the table.

Table 111 Save operations attributes for Window disaster recovery

Task	Entry in Save Operations attribute	Result
Completely disable the DISASTER_RECOVERY:\ save set.	VSS:DISASTER_RECOVERY=off Default: No value, which means that the All save set will include the DISASTER_RECOVERY:\ save set.	The DISASTER_RECOVERY:\ save set is not included in the All save set. Instead, the All save set is consistent with pre-7.6 SP2 NetWorker. This means that the save set All will consist of the following save sets: <ul style="list-style-type: none"> • VSS SYSTEM BOOT • VSS SYSTEM FILESET • VSS SYSTEM SERVICES • VSS USER DATA • All local physical drives
	<p>IMPORTANT</p> <p>If this option is used, it is recommended that you create a second client resource for the host and set up a scheduled back up of the DISASTER_RECOVERY:\ save set for the second client resource. This will ensure that you can perform a Windows DR for the host. “Putting disaster recovery backups on a different schedule” on page 642 provides an example.</p>	

Table 111 Save operations attributes for Window disaster recovery (continued)

Task	Entry in Save Operations attribute	Result
Limit the backup of dynamic volumes when only some dynamic volumes are critical volumes.	VSS:SAVE_NONCRITICAL_DYNAMIC_DISKS=off Default: No value, which means that non-critical disks that are in a critical dynamic disk pack will be saved with the DISASTER_RECOVERY:\ save set.	Do not save non-critical dynamic disks when they are in a critical dynamic disk pack.
	<p>IMPORTANT</p> <p>If this option is used, ensure that the non-critical dynamic disks are backed up. Otherwise, data loss could occur because all dynamic disks will be reformatted during a Windows DR operation. You can back up the non-critical dynamic disks by specifying the save set All in the client resource's Save Set attribute.</p>	
Disable the backup of non-critical volumes that have mount points for critical volumes.	VSS:SAVE_NONCRITICAL_MNTPARENT_DISKS=off Default: No value, which means that a non-critical parent volume that has a critical volume mounted to it will be saved with the DISASTER_RECOVERY:\ save set.	If at least one critical volume is mounted on a non-critical volume, do not back up the non-critical volume with the DISASTER_RECOVERY:\ save set.
	<p>IMPORTANT</p> <p>If this option is used, ensure that all non-critical volumes are backed up. Otherwise, user data may not be available for an online recovery. You can back up all non-critical volumes by specifying the save set All in the client resource's Save Set attribute.</p>	

Putting disaster recovery backups on a different schedule

This section includes some examples of how one can optimize backup schedules to reduce the size and frequency of backups.

Example 48 Taking disaster recovery backups less frequently than regular backups

You may find that taking a disaster recovery backup every two weeks is adequate. However, you want to take Full backups of your data, including VSS system state data, more frequently.

To set up different schedules for your disaster recovery backups and your regular backups, do the following:

1. Set up two NetWorker client resources for the host you are backing up.
2. In the first client resource, set the following attributes:
 - Save Operations — **VSS:DISASTER_RECOVERY=off**
 - Save Set — **All**
 - Schedule — select a schedule that performs a Full level backup weekly.
 - Group — ensure that the two client resources are not part of the same group.

The following data will undergo a Full back up every week:

- VSS SYSTEM BOOT
- VSS SYSTEM FILESET
- VSS SYSTEM SERVICES
- VSS USER DATA
- All local physical drives

3. In the second client resource, set the following attributes:

- Save Operations — *no value*
- Save Set — **DISASTER_RECOVERY:**
- Schedule — select a schedule that performs a Full level backup once every two weeks.
- Group — ensure that the two client resources are not part of the same group.

The DISASTER_RECOVERY:\ save set will be backed up every two weeks.

This chapter covers these topics:

- ◆ Overview of VSS..... 646
- ◆ VSS and the backup process 646
- ◆ Controlling VSS from NetWorker software..... 648

Overview of VSS

If the NetWorker Module for Microsoft Applications is installed on the client computer, information in this chapter may be superseded by information in the NetWorker Module for Microsoft Applications documentation. The *EMC NetWorker Module for Microsoft Applications Administration Guide* provides more information about the NetWorker Module for Microsoft Applications.

Volume Shadow Copy Service (VSS) is a Microsoft technology that acts as a coordinator among all the components that create, archive, modify, back up, and restore data, including:

- ◆ The operating system
- ◆ Storage hardware
- ◆ Applications
- ◆ Utility or backup programs, such as NetWorker software

VSS allows for the creation of a point-in-time *snapshot*, or temporary copy, of a volume. Instead of backing up data directly from the physical file system, data is backed up from the snapshot. In addition, VSS allows for a single, point-in-time capture of the system state.

In NetWorker software releases 7.2 and later, if a VSS client license is present, NetWorker software uses VSS technology to create snapshot backups of volumes and exact copies of files, including all open files. Microsoft Vista or Microsoft Server 2008 do not require a VSS client license. Databases and files that are open due to operator or system activity are backed up during a volume shadow copy. In this way, files that have changed during the backup process are copied correctly.

Shadow copy (snapshot) backups ensure that:

- ◆ Applications can continue to write data to the volume during a backup.
- ◆ Open files are no longer omitted during a backup.
- ◆ Backups can be performed at any time, without locking out users.

Note: VSS backups do not use snapshot policies, which are required to perform backups with the NetWorker PowerSnap Module software. The EMC PowerSnap Module documentation provides more information.

VSS and the backup process

In VSS terms, NetWorker software is a requestor — an application that needs data from other applications or services. When a requestor needs data from an application or service, this process occurs:

1. The requestor asks for this information from VSS.
2. VSS reviews the request for validity.
3. If the request is valid and the specified application has the requested data, the request goes to the application-specific writer, which prepares the requested data.

Each application and service that supports VSS has its own writer, which understands how the application or service works:

1. After the writer signals that it has prepared the data, VSS directs the writer to freeze I/O to the selected volumes, queuing it for later processing.

2. VSS then calls a *provider* to capture the requested data.
3. The provider, which is either software-based or associated with particular hardware (for example, a disk array), captures the prepared data, creating a snapshot (or shadow copy) that exists side-by-side with the live volume.

Note: Be aware that hardware providers are not supported by the NetWorker client at this time. See “[Provider support](#)” on page 648 for more information.

The process of creating a snapshot involves interaction with the operating system. The amount of time it takes to create a snapshot depends on a number of factors, including the writer activity taking place at the time. Once the snapshot is created, the provider signals VSS, which tells the writer to resume activity. I/O is released to the selected volumes and any queued writes that arrived during the provider's work are processed.

Figure 58 on page 647 provides a graphical representation of the VSS backup process.

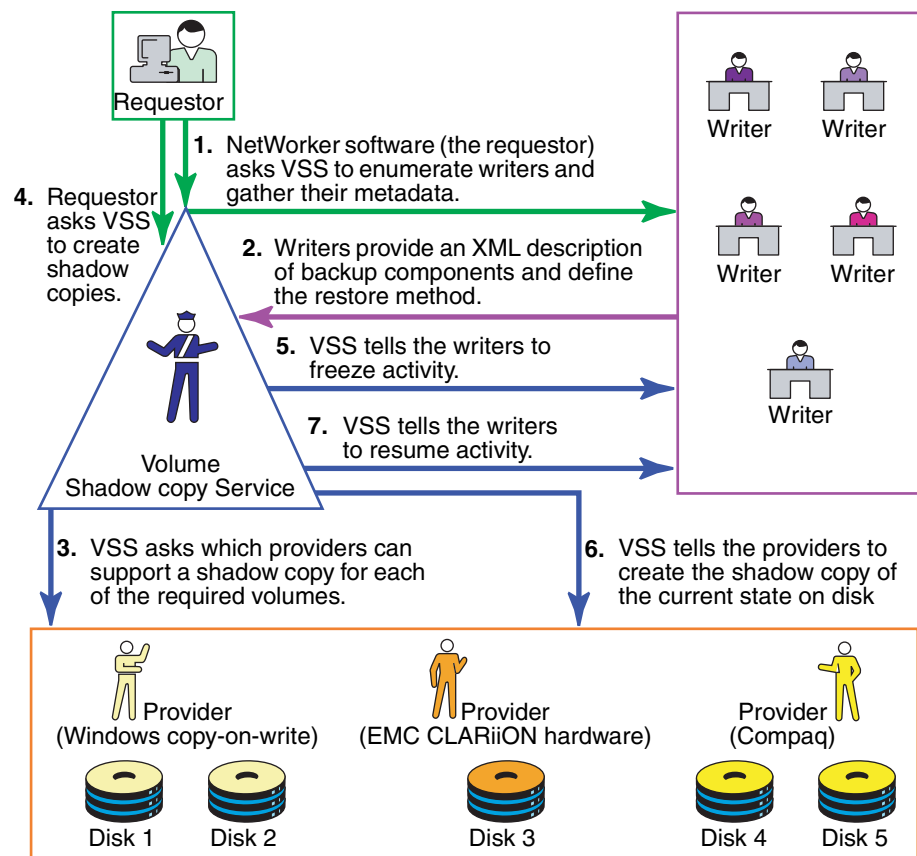

Figure 58 VSS backup process

NetWorker software backs up data from the point-in-time snapshot that is created during this process. Any subsequent data access is performed on the snapshot, *not* the physical file system. The requestor has no direct contact with the provider—the process of taking a snapshot is seamlessly handled by VSS. Once the backup is complete, VSS deletes the snapshot.

Provider support

The NetWorker client does not currently support hardware providers for backup operations. Only software providers are currently supported. If you are using a hardware provider, perform one of the following workarounds as appropriate:

- ◆ Uninstall the hardware providers.
- ◆ Migrate any data that is backed up by the NetWorker client to a disk LUN (Logical Unit Number), such as C:\, that is not controlled by a hardware provider. In this way, the NetWorker client will backup all data using the software provider.

Be aware that if the NetWorker Module for Microsoft Applications is installed on the client host, then the previously mentioned workarounds may not be required. Refer to the NetWorker Module for Microsoft Applications documentation for details.

The importance of writers

Writers play an important role in properly backing up data. They provide metadata information about what data to back up, and specific methods for properly handling components and applications during backup and restore. They also identify the type of application or service that is being backed up, for example System Boot or System Services. Writers do *not* play a role in backing up the file system.

Writers are currently only available for active services or applications. If a service or application is present on a system but is not active, information from its writer will not be available. Consequently, a writer can appear or disappear from backup to backup.

In addition, NetWorker software maintains a list of supported writers in the NSRLA database of the client machine. When backing up data, the software confirms that a VSS client license exists, and then it checks to ensure that these conditions exist:

- ◆ The writer associated with the application is present on the system and active.
- ◆ The writer appears on the list of supported writers in the NSRLA database.
- ◆ A user has not disabled the writer.

If these conditions are all true for a particular writer, NetWorker software defaults to backing up data by using VSS technology. If any of the conditions are false for a particular writer, the data served by that writer is excluded from the backup operation.

List of supported writers

During a VSS backup operation, NetWorker software validates each writer against a list of supported writers. As part of a software release, or between releases, there may be updates to the list of supported writers. The *EMC NetWorker Software Compatibility Guide* provides a list of the currently supported writers.

Controlling VSS from NetWorker software

By default, NetWorker software release 7.2 and later uses VSS technology to back up a client that is also running release 7.2 or later, and is licensed to use VSS. For VSS SYSTEM save sets, this means NetWorker software uses VSS for most save sets and writers. [Appendix A, "SYSTEM and VSS SYSTEM Save Sets"](#) provides details). For the file system, this means the software attempts to take a snapshot of each drive, but

if it fails, then it saves the file system by using the legacy method (that is, no snapshot is taken). During a given backup for an individual client, either the VSS method or the legacy method is used, but not both.

There may be times when you need finer control over how NetWorker software uses VSS. For example, if you need to disable a writer or completely disable VSS. You can control VSS from the Administration window, the NetWorker User program, or the command prompt.

Note: With Windows Vista and Windows Server 2008, VSS is the only available backup method and cannot be disabled.

These sections provide more information:

- ◆ [“Controlling VSS from the Administration window” on page 649](#) provides details on how to control VSS from the Administration window.
- ◆ [“Controlling VSS from the NetWorker client” on page 650](#) provides details on how to control VSS from the NetWorker User program.
- ◆ [“Control VSS from the command-prompt” on page 651](#) provides details on how to control VSS from the command prompt.
- ◆ [“Globally disabling VSS” on page 651](#) provides details on how to disable VSS globally.

Note: The documentation that accompanied the VSS client license describes how to control VSS when backing up a client that is running NetWorker software release 7.2 or later, where the NetWorker *server* is running a prior release of NetWorker software.

Controlling VSS from the Administration window

To control VSS from the Administration window:

1. From the **Administration** window, click **Configuration**.
2. Click **Clients**.
3. Right-click the client for which you want to control VSS, then select **Properties**. The **Properties** dialog box appears, with the **General** tab displayed.
4. Click the **Apps & Modules** tab.
5. In the **Save Operations** attribute, type the appropriate command according to [Table 112 on page 652](#), then click **OK**.
 - Separate multiple commands with a semicolon (;).
 - If the **Save Operations** attribute is left blank, NetWorker software backs up data by using VSS if a VSS client license is present.

Notes:

1. The **Save Operations** attribute does not support NetWorker Module save sets. If a NetWorker Module save set name is entered in the window, the backup fails.
2. If you enter a VSS command in the **Save Operations** attribute of the **Administration** window, the command runs when the client backup is started as part of a save set. If you enter a VSS command in the **Local Save Operations** dialog box on the client, the command runs only if the backup is started by using the NetWorker User program on the client.

3. When typing a writer name in the **Save Operations** attribute, the name must match the name that the writer uses to identify itself. If the name does not match, the command is ignored.
 - To confirm the name, open the NetWorker User program and browse the corresponding save set.
 - Remember that the list of writers appearing under each save set is dynamically determined at runtime.
 - A writer might not appear under its corresponding save set under the following conditions:
 - NetWorker software does not support the writer.
 - The writer's associated application, service, or database is not currently running on the system.
 - The writer has already been disabled by using the NetWorker User program.
4. Use the **Save Operations** attribute only for clients running NetWorker software release 7.2 or later. If anything is entered in this attribute for a client that is running an earlier NetWorker software release, the backup will fail.

Controlling VSS from the NetWorker client

The Local Save Operations dialog box is read-only once the Backup window is opened. To modify local save operations after opening the Backup window, exit and restart the NetWorker User program.

To modify Local Save Operations, run only one instance of the NetWorker User program at a time.

To control VSS from the NetWorker client:

1. Start the NetWorker **User** program.
2. From the **Options** menu, select **Save Operations**.
3. In the **Local Save Operations** dialog box, type the appropriate command according to [Table 112 on page 652](#), then click **OK**. Separate multiple commands with a semicolon (;).

If the **Local Save Operations** dialog box is left empty, NetWorker software backs up data by using VSS if a VSS client license is present:

- Local Save Operations does not support NetWorker Module save sets. If a NetWorker Module save set name is entered in the window, the backup fails.
- If you enter a VSS command in the **Save Operations** attribute of the **Administration** window, the command runs when the client backup is started as part of a save set. If you enter a VSS command in the **Local Save Operations** dialog box on the client, the command runs only if the backup is started by using the NetWorker User program on the client.
- When typing a writer name in the **Local Save Operations** dialog box, the name must match the name the writer uses to identify itself. If the name does not match, the command is ignored.
 - To confirm the name, browse the corresponding save set in the **Backup** window.
 - Remember that the list of writers that appear under each save set is dynamically determined at runtime.
- A writer might not appear under its corresponding save set if:

- NetWorker software does not support the writer.
- The writer's associated application, service, or database is not currently running on the system.
- The writer has already been disabled using the NetWorker User program.

Control VSS from the command-prompt

VSS can be controlled from the command-prompt on a NetWorker client or the Console server by using the **-o** option and the Save Operations commands in [Table 112 on page 652](#), but only while performing a **save**, **savefs**, or **nsrchive** operation.

For example, to completely disable VSS while backing up C:\myfile to the server *jupiter*, type:

```
save -s jupiter -o "vss:*=off" "C:\myfile"
```

Although the server name is not required in the preceding command example, include the name to ensure that the **save** command finds the correct server. Separate multiple Save Operations commands with a semicolon (;).

The *EMC NetWorker Command Reference Guide* provides more information about the **save**, **savefs**, and **nsrchive** commands and command options.

Note: If you change the VSS setting on a client by using the Local Save Operations dialog box or the command prompt, it does not affect that client's VSS setting on the server. Likewise, if you change a client's VSS setting on the server, it does not affect the Local Save Operations setting or the command-prompt VSS setting on the client.

Globally disabling VSS

Use the **nsradmin** program to disable VSS for all clients globally or only for clients with a certain Windows operating system.

Note: With Windows Vista and Windows Server 2008 and later Windows releases, VSS is the only available backup method and cannot be disabled.

To disable VSS:

1. Log in as root or as Windows Administrator on the NetWorker server.

To disable VSS for all NetWorker clients:

- a. Create an input file for the **nsradmin** command. The input file will eliminate interactive prompting as each client gets updated. For example, create a text file named `disable-vss.txt` and type the following into the file:

```
show name; client OS type; Save operations
print type: NSR client
update Save operations: "VSS\:=off"
print
```

To disable VSS only for clients on a particular Windows operating system such as Windows NT:

- a. Create an input text file, for example, create a file named `disable-vss-nt.txt` and type the following into the file:

```
show name; client OS type; Save operations
```

```
print type: NSR client; client OS type: "Windows NT Server on
Intel"
update Save operations: "VSS\:*=off"
print
```

2. Type either of the following at the command prompt:

```
nsradmin -i <path>\disable-vss.txt
```

```
nsradmin -i <path>\disable-vss-nt.txt
```

where *<path>* is the directory location of the input file.

VSS commands

Table 112 on page 652 lists the commands and syntax used to control VSS, along with a description of what each command does. These commands may be entered in any of these locations:

- ◆ Save Operations attribute of a NetWorker client resource.
- ◆ Local Save Operations dialog box of the NetWorker User program on the NetWorker client.
- ◆ Command prompt on the NetWorker client or the Console server.

Table 112 VSS commands

Task *	Entry	Result
Enable VSS.	This attribute should be left empty.	Leaving the attribute empty will result in NetWorker software automatically using VSS (if VSS is licensed).
Completely disable VSS.	VSS:*=off	The file system and the system components are backed up by using the legacy method, which means that the backup is performed without taking a snapshot.
Disable VSS for a particular drive.	VSS:drive:=off For example: VSS:c:=off	The specified drive is backed up by using the legacy method.
Disable an individual writer.	VSS:writer=off where <i>writer</i> is the name of the writer to disable. For example: VSS:WINS Writer=off	The application data served by <i>writer</i> is not saved, unless a NetWorker Module exists for that application and is installed and configured on the system. Note: When a writer is disabled, NetWorker software still processes the writer so its files are skipped during the file system backup.
Instruct NetWorker software to back up the file system by using VSS only.	VSS:root drive path=only To indicate all drives, enter: VSS:*=only For example: VSS:C:=only	All VSS SYSTEM save sets, writers, and file systems are backed up by using VSS. However, if VSS fails, instead of backing up the file system by using the legacy method, the specified drive is not backed up at all.

* For VSS commands related to Disaster Recovery for Windows 2008, 2008 R2, and Windows 7, see [“Save Operations attributes for Windows Disaster Recovery” on page 641](#).

Handling MSDE, SQL Server, and Microsoft Exchange databases

This release of NetWorker software does not support VSS backups of Microsoft Exchange Server databases or SQL Server databases, but *does* support VSS backups of MSDE databases through the MSDE writer. The MSDE writer was designed to handle backups of both MSDE databases and SQL Server databases. If you perform a backup operation that includes the MSDE writer, and both MSDE and SQL Server databases exist on the same system, NetWorker software excludes the SQL Server databases from the backup operation and backs up only the MSDE databases. If only SQL Server databases exist under the MSDE writer, NetWorker software excludes the entire writer from the backup operation.

If you used a previous release of NetWorker software to perform a VSS backup of Exchange Server databases or SQL Server databases, you can use this release to recover them. Since they were previously backed up by using VSS, they will be recovered by using VSS.

Note: The NetWorker Module for Microsoft Applications provides full support for backing up Microsoft database applications. The *EMC NetWorker Module for Microsoft Applications Administration Guide* provides more information.

Authoritative restores of the Active Directory Application Mode (ADAM) writers

Authoritative restores of the ADAM writer must be performed from the command line. Restores from the NetWorker User GUI are nonauthoritative.

To perform an authoritative restore of the ADAM writer, use the -U option for the recover command. To recover the ADAM writer, type the following command:

```
recover -s server -U -N "VSS USER DATA:\ADAM (Address Book) Writer"
```

This chapter covers these topics:

- ◆ Introduction to HomeBase Support (NetWorker Enhanced Server Recovery).. 656
- ◆ NetWorker Enhanced Server Recovery backups..... 657
- ◆ Recovering with BMR..... 658

Introduction to HomeBase Support (NetWorker Enhanced Server Recovery)

This section provides information on NetWorker Enhanced Server Recovery, which adds an EMC HomeBase server into the NetWorker environment.

Windows Disaster Recovery versus NetWorker Enhanced Server Recovery

NetWorker Windows Disaster Recovery is built into the NetWorker client and supports bare metal recovery to the same or similar hardware for Windows Server 2008, Windows Server 2008 R2 and Windows 7.

NetWorker Enhanced Server Recovery with EMC HomeBase (purchased separately) is an enterprise recovery solution designed to:

- ◆ Recover multiple servers in parallel.
- ◆ Support challenging Recovery Time Objectives (RTOs).
- ◆ Provide levels of automation and customization required for the enterprise environment.
- ◆ Provide recoveries to the same or different hardware, from physical to virtual, and from virtual to physical recoveries.

Supported operating systems include Windows Server 2008 R2, Windows Server 2008, Windows Server 2003 and Red Hat Linux.

NetWorker BMR HomeBase Server

A NetWorker BMR server is an EMC HomeBase Server that manages and restores operating system and server state data, collected as profiles. The HomeBase Server is the collection point for profiles produced by HomeBase Agents. HomeBase Agents are installed on each protected NetWorker client.

The profile data includes:

- ◆ hardware configurations
- ◆ operating system levels
- ◆ system tuning
- ◆ network connections
- ◆ security
- ◆ storage layouts

The HomeBase Agent captures this information on a scheduled basis with a NetWorker save set, and sends the profile results to a HomeBase Server for management and analysis.

Installation considerations

The HomeBase Server installation is separate from the NetWorker server installation. The HomeBase Server must be configured and available when:

- ◆ The NetWorker BMR client resource is created.
- ◆ The BMR backup data (profiles) are generated from NetWorker clients.

The EMC HomeBase product documentation provides details about HomeBase Server installation, profile management, and recovery specifics.

The NetWorker *Installation Guide* provides information on how to install and enable the BMR agent.

NetWorker Enhanced Server Recovery backups

NetWorker clients can be configured to take advantage of EMC HomeBase BMR technology to ensure that a client can be restored or migrated from one hardware type to another. When a backup is run on a client, a HomeBase profile is automatically generated and saved to a specified HomeBase Server. This process is enabled with a HomeBase Agent license.

Requirements for Windows Enhanced Server Recovery

To provide Enhanced Server Recovery support for NetWorker clients on the following platforms, the Homebase 6.4.1 or later agent is required. Additionally, the protected host must be running NetWorker 7.6 Service Pack 1 Cumulative Update 1 (7.6.1.1) or later.

- ◆ Windows Server 2008 R2
- ◆ Windows Server 2008 SP2
- ◆ Windows Server 2003 SP1 or later
- ◆ Windows Server 2003 R2 SP1 or later

Information about upgrading to and configuring the Homebase 6.4.1 or later agent is available in the *HomeBase Agent Installation and Configuration Guide*. Information on BMR recovery is available in the *HomeBase Agent Recovery and Migration Guide*.

Configuring a client for BMR support

To configure a NetWorker client for Enhanced Server Recovery support, perform the following tasks:

Task 1: Enable Homebase server support

Connection with a HomeBase Server is enabled during the set up of the NetWorker server. This connection enables the delivery of profile data from the NetWorker client to the HomeBase Server.

To enable Homebase server support:

1. From the **Administration** window, click **Configuration**.
2. Select the NetWorker server name.
3. From the **File** menu, select **Properties**.
4. In the **Properties** dialog box, click the **Configuration** tab.
5. Type the IP address or hostname for the HomeBase Server in the BMR server field.
6. Click **OK**.

Note: A HomeBase Agent license batch code is required to enable the client to generate profiles and send them to the HomeBase Server. Contact your EMC HomeBase representative for licensing information.

Task 2: Configure a client for Homebase backup

After enabling communication with a HomeBase Server, configure a NetWorker client as follows (or start by editing an existing client).

To configure a Homebase BMR backup for a client:

1. From the **Administration** window, click **Configuration**.
2. Click **Clients**.
3. Right-click the client to be enabled, then select **Properties**. The **Properties** dialog box appears.
4. Click the **Globals (2 of 2)** tab.
5. Click the **BMR** check box.
6. Type the following in the **BMR options** field:

```
-L license_batch_code
```

Additional options can be specified in this field that define how the profile is generated. The EMC HomeBase product documentation for HomeBase Agent command line options provides more information.

Note: If there is a change to the HomeBase Server or license batch, the new license must be updated.

7. By default, NetWorker 7.6 Service Pack 2 or later clients do not include VSS SYSTEM save sets in a backup when the All save set keyword is specified in the client's **Save set** attribute. VSS SYSTEM save sets are required for a BMR backup. To ensure that VSS SYSTEM save sets are included when the All keyword is specified, perform the following steps.
 - a. Click the **Apps & Modules** tab.
 - b. Type the following entry in the **Save operations** attribute:

```
VSS:DISASTER_RECOVERY=off
```

[“VSS SYSTEM save sets” on page 714](#) provides more information about the components of VSS savesets.
8. Click **OK**.

The HomeBase profile, used during a Homebase BMR recovery, is generated when the client's scheduled save set is run. The profile is then stored in the HomeBase Server.

Recovering with BMR

This section provides an outline of the steps required to perform a Homebase BMR recovery or server migration. The EMC HomeBase product documentation provides complete details and instructions about the HomeBase Server and HomeBase Agents.

A Homebase BMR recovery is performed from the HomeBase Server and Console in the following order:

1. On the new machine, deploy an operating system that matches the operating system of the profiled client that is being restored.

Windows and Linux operating systems can be deployed from the HomeBase Server web pages. UNIX operating systems are deployed manually with package matching and validation performed through the HomeBase Server web pages.

2. Install a NetWorker client on the machine that will serve as the recovery server. The machine on which the client data is recovered does not need to match the hardware of the original client.

Note: The Console server and the HomeBase Server must be able to communicate with the recovery server.

3. The HomeBase Server will communicate with the client through a HomeBase Agent license batch. Communication can be established from the client command line using the **hba licensing announce** command. The *EMC HomeBase Agent Installation and Configuration Guide* provides details, or enter **hba -h** for command usage.
4. From the HomeBase Server web pages, restore the base profile onto the new machine. The *EMC HomeBase Agent Recovery and Migration Guide* provides platform specific information.

Note: The base profile will configure the new client to match the IP and network configuration of the client that was profiled. To avoid IP conflicts on the network, make sure that the original client is not available.

5. Reboot the client.
6. From the client, recover the client data. [“Choosing a recovery method” on page 316](#) provides more information.

If recovering a Windows client, also recover the Windows system state. To recover the Windows system state, recover the VSS SYSTEM save sets in the following order:

- VSS SYSTEM SERVICES
- VSS SYSTEM FILESET
- VSS USER DATA
- VSS OTHER
- VSS SYSTEM BOOT

7. Ensure that the **Options > Exclusion Options > Exclusion File List > Perform special handling for Bare Metal Recovery** checkbox is selected. This automatically excludes files that the HomeBase Server has recovered with the base profile restore.

Note: The exclude.NETWORKER file is located in the HomeBase Agent exclude subdirectory and can be edited to exclude additional data. However, this should be done with extreme care.

8. From the HomeBase Server web pages or the client command line, restore the extended profile. The *EMC HomeBase Agent Installation and Configuration Guide* for details provides more information, or enter **hba -h** for command usage.

The extended profile must exist on the client. It can be downloaded from the HomeBase Server web pages or restored through the data recovery in [step 6](#).

9. Reboot the recovered client.

Excluding files for Homebase BMR recovery

A HomeBase profile restore is one of the first steps in a BMR recovery. A NetWorker client data restore may restore files that were previously restored by HomeBase. An exclusion file is provided to ensure that there is no overlap between a HomeBase profile restore and the NetWorker client data restore. The EMC HomeBase Recovery Guides provide complete information about excluding files from recovery.

Before performing a data restore in a BMR recovery, enable the use of the default exclude file.

To enable the exclude file:

1. In the NetWorker **User** program, select **Exclusion Options** from the **Options** menu.
2. In the **Exclusion File List** dialog box, select the **Perform special handling for Bare Metal Recovery** check box.
3. To add a custom exclude file, enter the full path in the field provided and click **Add**.

IMPORTANT

Custom exclude lists should be used with caution and tested before recovery to a production system is performed.

4. Click **OK**.

This chapter covers these topics:

◆ Before contacting technical support	662
◆ Viewing log files	663
◆ NetWorker functionality issues	667
◆ Devices and autochangers	679
◆ NetWorker locale and code set support	687
◆ Resource database notes	687
◆ Network and server communication errors	688
◆ UNIX communication issues	691
◆ Microsoft Windows communication issues	696
◆ NetWorker archiving and retrieval	698
◆ Storage nodes	699
◆ Console error messages and corrective actions	701
◆ Console log files	703
◆ Console troubleshooting notes and tips	704

Consult the *NetWorker Error Message Guide* for common error messages and possible resolutions.

Before contacting technical support

If the solutions in this chapter do not solve the problem, go to the EMC Powerlink website for technical assistance. Provide this information:

- ◆ The software version of the NetWorker component.
- ◆ The operating system version.
For example:
 - For Solaris, at the command prompt type the **uname -a** command.
 - For AIX, at the command prompt type the **oslevel** command.
- ◆ The hardware configuration.
- ◆ Information about devices and other SCSI IDs.
To determine this information, use the following commands:
 - For AIX, IRIX, Linux, and Solaris, enter the **/usr/sbin/inquire** command.
 - For HP-UX, enter the **/etc/ioscan** command.
- ◆ If you are using an autochanger, the type of connection (SCSI or RS-232). Also, provide the version of the autochanger driver you are using:
 - For Solaris, enter the **pkginfo -x** command:

```
# pkginfo LGT0drv
```
 - For AIX, enter the **lspp -l | grep EMC** command.
- ◆ Be able to supply this information:
 - How to reproduce the problem.
 - The exact error messages.
 - Number of times you have seen the problem.
 - Whether the NetWorker command was successful before you made any changes and, if so, the changes you made.

Determining the version of NetWorker software running on a client

To determine the version of the NetWorker software running on a client, use either the NetWorker client interface or the **nsradmin** command.

Determining the software version by using the client interface

To determine the software version by using the client interface:

1. Open the NetWorker client program:
 - On Windows, open the NetWorker **User** program.
 - On UNIX, open the **nwrecover** program.

[Chapter 1, "Overview"](#) provides more information about opening these programs.
2. From the **Help** menu, select **About NetWorker User**. The NetWorker version number appears in the **About** dialog box.
3. Click **OK** to close the dialog box.

Determining the client software version by using nsradmin

To determine the client version by using **nsradmin**:

1. At the command prompt, type:

```
nsradmin -p nsrexecd
```

2. At the **nsradmin** command prompt, type:

```
nsradmin> show NetWorker version  
nsradmin> print type: NSRLA
```

The version of NetWorker software running on each client is displayed.

Displaying diagnostic mode attributes

NetWorker resources such as clients and devices contain diagnostic attributes that are hidden by default.

To display diagnostic attributes:

1. Open the **Administration** window.
2. From the **View** menu, select **Diagnostic Mode**.
3. Right-click any resource and select **Properties** to see diagnostic attributes.

Viewing log files

For NetWorker release 7.4 and later, the log files viewed by using the **nsr_render_log** (UNIX/Linux) or **nsr_render_log.exe** (Microsoft Windows) program include:

- ◆ Daemon log file (daemon.raw)
- ◆ gstd log file (gstd.raw)
- ◆ NetWorker User log file (networkr.raw; Microsoft Windows only)

The **nsr_render_log** program renders internationalized NetWorker log files into the current locale of the user who is executing the program. All other log files, as well as messages displayed in the NetWorker Console, use the locale of the service that is generating the log message.

The **nsr_render_log** program is non-interactive. You must specify the log file at the command line when the **nsr_render_log** program is executed. The output of the command is printed to stdout, and can be redirected to a file to save the output. A number of command line options are available with the **nsr_render_log** program as well.

Rendering log files in the current locale at runtime

You can also instruct the NetWorker software to render log files into the current locale at runtime, in addition to creating locale-independent log files. This allows you to view log files by using a text viewer.

To instruct the NetWorker software to render logs in the current locale of the machine hosting the file, set the runtime rendered log file in the NSRLA database to the full path of the location for the rendered log file. This must be a valid path.

For backward compatibility with previous releases of NetWorker software, runtime rendered log files do not display all of the fields that are displayed using the **nsr_render_log** program. The runtime rendered log files will contain the message ID followed by the date and time the message was logged, and then the rendered message.

How to render log files in the current locale at runtime

To instruct the NetWorker software to render log files into the current locale at runtime:

1. Log in as root or as Windows administrator on the NetWorker client.

Note: You must have security administrator privileges to view security audit logs.

2. Type this at the command prompt:

```
nsradmin -p nsrexec
```

The **nsradmin** prompt appears.

3. To display a list of all available log file resources:

- a. Type the following at the **nsradmin** prompt:

```
. type: NSR log
```

- b. Next, type the following:

```
print
```

A list of all available log file resources will be displayed.

4. Select the appropriate log file resource for editing by typing the following at the **nsradmin** prompt:

```
. type: NSR log; name: log_file_name
```

For example, to select the `daemon.raw` file, type the following:

```
. type: NSR log; name: daemon.raw
```

5. Set the path for the **Runtime rendered log** attribute by typing the following at the **nsradmin** prompt:

```
update runtime rendered log: log_file_location
```

For example, to set the location of the rendered daemon file to the NetWorker log file direction on Microsoft Windows, type the following:

```
update runtime rendered log: "C:\\Program  
Files\\Legato\\nsr\\logs\\daemon.log"
```

How to view log files with the **nsr_render_log** program

To view log files with the **nsr_render_log** program, execute the following at the command line:

```
nsr_render_log log_file_name
```

If there are spaces in the log file path name, the path and filename should be enclosed in double quotes. For example:

```
nsr_render_log "C:\\Program Files\\Legato\\nsr\\logs\\daemon.raw"
```

Note: The `nsr_render_log` program is located in the bin directory of the NetWorker installation. If the bin directory is not in your search path, you must include the location of the program when executing it from the command line.

The *EMC NetWorker Command Reference Guide* or the UNIX man page provide a complete usage information for the `nsr_render_log` program.

How to redirect `nsr_render_log` output to a file

To redirect `nsr_render_log` output to a file, use the `>` character:

```
nsr_render_log "C:\Program Files\Legato\nsr\logs\daemon.raw" >
mylog.txt
```

You can also save the log file by using a special separator character for export to another program, such as a spreadsheet. To do this, use the `-x exportspec` option, where *exportspec* is a `c` followed by the separator character.

For example, to create a comma-separated list:

```
nsr_render_log -x c, "C:\Program Files\Legato\nsr\logs\daemon.raw" >
mylog.csv
```

Viewing log files from remote host machines

The `nsr_render_log` program allows you to view log files from remote NetWorker hosts, by using the `-R hostname` option:

```
nsr_render_log -R hostname log_file_name
```

When the `-R` option is used, the log file will be rendered in the locale of the user executing the `nsr_render_log` program, regardless of the locale that is running on the remote host.

Log files from previous releases of NetWorker

For log files generated by clients that are running releases prior to release 7.4, or for preexisting log files that were created before upgrading to from a release prior to release 7.4, do not use the `nsr_render_log` program to view the log files. These log files, which will use the previous naming convention of `*.log`, should be viewed by using a standard text editor such as `notepad.exe` or `vi`.

Filtering log file information displayed by `nsr_render_log`

A number of command line options are available for the `nsr_render_log` program to narrow the information output by the program. For example, to view only log file messages referencing a specific device, use the `-D devicename` option.

The *EMC NetWorker Command Reference Guide* or the `nsr_render_log` man page provide a complete list of available options.

Viewing only the most recently logged messages

To view only the most recently logged messages in the log file, use the **-B** *beginning_line* option. If *beginning_line* is specified using a negative number, this will instruct the **nsr_render_log** program to display only the specified number of lines from the end of the file.

For example, to display only the last 100 lines from the log file, run the following command:

```
nsr_render_log -B -100 "C:\Program Files\Legato\nsr\logs\daemon.raw" >
mylog.txt
```

Locating savegroup job logs

If the **Savegroup log by job id** attribute on the NetWorker server resource is selected, you can use the **jobsquery** command to locate logs for child jobs of a savegroup operation. This command takes a query, or query file, and searches the jobs database on the NetWorker server.

Example 49 Using the jobsquery program

This example shows how you could use the **jobsquery** program to locate the child jobs of a savegroup job:

1. Open the **jobsquery** program and use the **show** option to specify which job attributes to display.

```
# jobsquery
show type; command; completion status; start time; end time; job id;
parent job id; job log file
```

2. Use the **print** option to specify that only savegroup jobs will be displayed.

```
print type: savegroup job
```

The output shows that a savegroup with a job ID of 128000 completed successfully:

```
type: savegroup job;
command: ;
completion status: succeeded;
end time: 1228409390;
job id: 128008;
job log file: ;
parent job id: 0;
start time: 1228409364;
```

3. Use the **print** option to display all jobs whose parent job ID is 128008.

```
print parent job id: 128008
```

```
type: savefs job;
command: \
savefs -s daphne.lego.com -c daphne.lego.com -g Default -p -l full \
-R -v -F /usr/share/man/man1 /usr/share/man/man3;
completion status: succeeded;
end time: 1228409365;
job id: 128009;
job log file: /nsr/logs/sg/Default/128009;
parent job id: 128008;
start time: 1228409365;
```

```

type: index save job;
command: \
"save -s daphne.lego.com -S -g Default -LL -f - -m daphne.lego.com \
-V -l full -LL -W 78 -N
  index:c177b9a2-00000004-4936d6d0-4936d6cf-0001c000-69\
7aa04f /nsr/index/daphne.lego.com";
completion status: succeeded;
end time: 1228409388;
job id: 128012;
job log file: /nsr/logs/sg/Default/128012;
parent job id: 128008;
start time: 1228409388;

```

Notice that the job log file attribute in the previous display shows the location of the job logs for two child job IDs: 128009 and 128012.

The *EMC NetWorker Command Reference Guide* or the UNIX man pages provide more information about the **jobsquery** command.

NetWorker functionality issues

This section describes workarounds for NetWorker issues.

Backup and recovery

This section covers backup and recovery operations.

Checking the NetWorker services

If you have trouble starting NetWorker programs, the services might not be running properly. On Windows systems, determine if these processes are running.

If they are not, start them:

- ◆ On Windows systems, go to **Control Panel > Administrative Tools > Services**.
- ◆ On UNIX systems, enter one of these commands:

```
ps -ef | grep nsr
```

```
ps -ax | grep nsr
```

You should receive a response similar to this:

```

12217 ?      S   0:09 /usr/sbin/nsr/nsrexecd -s jupiter
12221 ?      S   2:23 /usr/sbin/nsr/nsrd
12230 ?      S   0:00 /usr/sbin/nsr/nsrmmdbd
12231 ?      S   0:01 /usr/sbin/nsr/nsrindexd
12232 ?      S   0:00 /usr/sbin/nsr/nsrmmmd -n 1
12234 ?      S   0:00 /usr/sbin/nsr/nsrmmmd -n 2
12410 pts/8  S   0:00 grep nsr

```

If daemons are not present, start the NetWorker daemons.

Client wizard issues

Improper font size for the Client Wizard with Netscape on Solaris

When using the Netscape browser on Solaris, the font size of the Client Wizard may be too small.

To change the font type and size:

1. Open the `/usr/bin/nwwiz` script in a text editor.
2. Edit the following line to change the font size:
`NSR_WIZARD_FONT_SIZE=size`
3. Save and close the `nwwiz` file.

Backups fail to start when daylight savings time change occurs

If backups are scheduled to occur during the hour in which the operating system moves the clock ahead or behind by one hour, the backup operation will be skipped. For example, suppose that the operating system is configured to move the clock forward one hour at precisely 2:00 A.M and backups are scheduled to occur at 2:01 A.M. At 2:00 A.M., the clock is moved forward to 3:00 A.M. All times from 2:01 to 2:59 are skipped and scheduled is not initiated.

To avoid this situation, set the backup time to occur at least one minute before the time change occurs.

Note: Using the `mminfo` query to get a weekly save set usage summary during the change to daylight savings time does not display any information for the day of the change.

Clone ID timestamp does not reflect the time the cone was created

To guarantee that cloned save sets created on different storage nodes do not have the same timestamp, the NetWorker software assigns a timestamp to cloned save sets that does not reflect the actual time that the clone was created.

Backups fail to stop

Attempting to stop the backup process by clicking Stop in the Group Control window should stop the process for all clients in the selected group. However, sometimes a client is missed and messages appear indicating that the server is still busy.

To resolve the problem:

1. From the **Administration** window, click **Monitoring**.
2. Select the **Groups** tab and determine which group is currently being backed up by looking at the messages that display.

If the group status shows that the **save** processes are running, but the associated **savegrp** process is not running, perform *one* of these:

- ◆ Stop the conflicting group from running by clicking **Stop** in the **Group Control** window. [“Stopping a group” on page 396](#) provides more information.
- ◆ Shut down and restart the NetWorker services. [“Stopping and starting a NetWorker server, client, or storage node” on page 51](#) provides more information.

Memory usage when browsing large save sets

Browsing or recovering from a large save set, such as a save set with one million or more files, may consume all of the host's memory. The workaround is to perform a save set recovery instead. [“Recovering by save set selection” on page 325](#) provides information on save set recovery.

The **recover** command enables you to directly browse the client file index and select the files and directories that you want to recover. Use this option to browse large save sets or when memory is limited on the host systems.

Memory usage and nsrjobd

The **nsrjobd** daemon runs on the NetWorker server and is responsible for monitoring NetWorker activity during a backup or recovery operation. Depending on the size of your backup environment, **nsrjobd** can require large amounts of RAM.

Media position errors encountered when auto media verify is enabled

To verify media, **nsrmmmd** must reposition the volume to read previously written data. It does not always succeed on the first attempt. These warning messages appear in the message window of the NetWorker Administration window:

```
media warning: /dev/rmt2.1 moving: fsr 15: I/O error
```

```
media emergency: could not position jupiter.007 to file 44, record 16
```

If the server can find the correct position, media verification succeeds and a successful completion message appears:

```
media info: verification of volume "jupiter.007" valid 30052
succeeded.
```

If media verification fails:

- ◆ Reset the device.
- ◆ Verify the configuration of the device.
- ◆ Verify that the media can be recognized.
- ◆ Verify that the device is functioning properly.

PACKET RECEIVE BUFFER and NO ECB counters increase

When the server is waiting for a tape to be mounted or is in the process of changing an autochanger volume, the PACKET RECEIVE BUFFER and NO ECB counters increase on a NetWare client.

To resolve this problem, shut down and restart the NetWorker server.

For servers that run on HP-UX, edit the `/sbin/init.d/networker` file. Add this line before the line that starts **nsrd**:

```
NSR_NO_PING=ok; export NSR_NO_PING
```

The scanner program marks a volume read-only

When you use the **scanner** program to rebuild the index of a backup volume, the **scanner** program marks the volume as read-only.

This is a safety feature that prevents the last save set on the backup volume from being overwritten.

To write to the media without marking it read-only, use the **nsrmm -o** command:

```
nsrmm -o notreadonly volume_name
```

The scanner program requests an entry for record size

If you use the **scanner** program with the **-s** option but without an **-i** or **-m** option, this message may appear:

```
Please enter record size for this volume ('q' to quit)
```

If this message appears, enter the block size. The block size must be an integer equal to or greater than 32.

Limitations for groups containing a bootstrap

Backups for a group that generates a bootstrap file can be written to a storage node only when a tape from the default pool is already labeled and mounted on a local drive attached to the NetWorker server.

Index recovery to a different location fails

If you attempt to recover indexes to a directory other than the one where they were originally located, this error message appears:

```
WARNING: The on-line index for client_name was NOT fully recovered.
There may have been a media error. You can retry the recover, or
attempt to recover another version of the index.
```

Recover indexes to their original location before moving them to another directory. To move the indexes, log in as root and invoke this command from within the `/nsr/index` directory:

```
uasm -s -i "client_index_directory_name" | (cd target_directory; uasm -r)
```

On Solaris and Linux platforms, **uasm** is installed in `/usr/lib/nsr`. On all other platforms, **uasm** is installed in the same location as the NetWorker binaries.

Illegal characters in configurations

When naming label templates, directives, groups, policies, and schedules, these characters are not allowed:

```
/ \ * [ ] ( ) $ ! ^ ' " ? ; ` ~ < > & | { }
```

Error backing up large number of clients

Backing up a large number of clients may cause this CMD.exe application error message to appear on the NetWorker server:

The application failed to initialize properly (0xc0000142). Click on OK to terminate the application.

If this problem occurs, increase the desktop heap allocation by editing the following Windows registry key on the NetWorker server:

```
HKEY_LOCAL_MACHINE\System\CurrentControlSet\Control\
  Session Manager\SubSystems\Windows
```

In the following example, the desktop heap allocation has been changed from a value of 512 KB to 1023 KB.

Previous version, with a desktop heap allocation of 512 KB:

```
%SystemRoot%\system32\csrss.exe ObjectDirectory=\Windows
SharedSection=1024,3072,512 Windows=On SubSystemType=Windows
ServerDll=basesrv,1 ServerDll=winsrv:UserServerDllInitialization,3
ServerDll=winsrv:ConServerDllInitialization,2 ProfileControl=Off
MaxRequestThreads=16
```

Updated version, with a desktop heap allocation of 1024 KB:

```
%SystemRoot%\system32\csrss.exe ObjectDirectory=\Windows
SharedSection=1024,3072,1024 Windows=On SubSystemType=Windows
ServerDll=basesrv,1 ServerDll=winsrv:UserServerDllInitialization,3
ServerDll=winsrv:ConServerDllInitialization,2 ProfileControl=Off
MaxRequestThreads=16
```

The Microsoft Knowledge Base article 18480 on the Microsoft website provides more information.

Hostname aliases

Savegroups fail when aliases are improperly defined. Under certain conditions, such as improperly configured DNS servers or hosts files, the NetWorker software does not create any aliases for a new client. If you use TCP/IP, every client should have both its hostname and its fully qualified domain name listed in its NetWorker aliases field.

If you encounter any of these situations, a client alias problem might be the cause:

- ◆ This error message appears:
No Client resource for *client_name*
- ◆ A client machine always performs full backups, regardless of the level of the scheduled backup.
- ◆ Automatic index management, as set up in the browse and retention policies, does not work.
- ◆ In the /nsr/index directory, which contains the indexes, there are two directories for the same client that use two different client names.

A client alias change is needed in the following situations:

- ◆ Machines have two or more network interfaces.
- ◆ Sites mix short and fully qualified hostnames for the same machines, for example, *mars* and *mars.jupiter.com*.

- ◆ Sites use both (Network Information Services (NIS) and DNS.

Add all network names for the host to the Aliases attribute in the Client resource.

Note: Do not include aliases that are shared by other hosts in the Aliases attribute.

Directory pathname restrictions

A file manager (but not Windows Explorer) restriction causes errors when a pathname contains too many characters.

To avoid these errors, use pathnames with fewer than 128 characters.

Failed recover operation directly after new installation

If you attempt to start the **nwrecover** program immediately after installing NetWorker software for the first time, this error message appears:

```
nwrecover: Program not found.
```

To avoid the problem, perform a NetWorker backup on the client.

Recovering files from an interrupted backup

If you terminate a backup by stopping the NetWorker services, you cannot recover the files because the media database is not updated when the services stop. Consequently, the NetWorker server does not know on which volumes the requested files reside.

Backup of a new client defaults to level full

The first time you back up a new client, this message appears:

```
client: save point: There are no save sets in the media database;
performing a full backup
```

This message indicates that the specified save set has not been previously backed up.

Before you can perform an incremental or level backup on a save set, perform a full backup of the save set.

If the save set was previously backed up, the reasons this message appears include:

- ◆ The clocks on the client and server are not synchronized.
- ◆ The **savegrp** session begins before midnight and ends after midnight.

Non-full backup of Solaris files with modified extended attributes

When the extended attributes for a Solaris file are changed, but the file is not otherwise modified, the change time (ctime) for the file is not updated. As a result, the NetWorker software does not know that the extended attributes for the file have changed since the last incremental backup, and any non-full scheduled backup of the file system will not back up the file.

To ensure the file is backed up, use the **touch** command or otherwise modify the file so that the ctime is updated. Alternatively, perform a manual backup of the file.

[“Manual backups” on page 64](#) provides more information.

Renamed clients cannot recover old backups

The NetWorker server maintains a client file index for every client it backs up. If you change the name of the client, the index for that client is not associated with the client's new name and you cannot recover files backed up under the old client name.

To recover data that was backed up by using the old client name, perform a directed recovery by directing data saved under the old client name to the new client. [“Directing recoveries to another client” on page 329](#) provides information about performing directed recoveries.

Client file index errors

These issues are related to client file indexes:

- ◆ [“Missing client file indexes” on page 673](#)
- ◆ [“Check failure of client file indexes” on page 673](#)
- ◆ [“No notification of client file index size growth” on page 673](#)

Missing client file indexes

The **scanner** program must have a client file index to rebuild from before it can proceed. If you attempt to recover a client file index with the **scanner -i** command without first using **nsrck -L2** to create a new client file index, a message similar to the following could appear:

```
scanner: File index error, file index is missing.
Please contact your system administrator to recover or recreate the
index.
(severity 5, number 8)
scanner: write failed, Broken pipe
scanner: ssid 25312: scan complete
scanner: ssid 25312: 91 KB, 13 file(s)
scanner: done with file disk default.001
```

Check failure of client file indexes

Each time the NetWorker server starts, it uses **nsrck -ML1** to perform a level 1 consistency check on the client file indexes. In some circumstances, this consistency check does not detect corruption in the client file indexes. If you believe an index might be corrupt, run a higher level check on the index, for example:

```
nsrck -L5
```

If the index is still corrupt, recover the index using the procedure outlined in [“Recovering a client file index from a specific time and date” on page 337](#).

No notification of client file index size growth

The NetWorker server does not notify you when a client file index is getting too large. Monitor the system regularly to check the size of client file indexes. [“Reducing client file index size” on page 459](#) provides information on how to manage the NetWorker client file indexes.

The *EMC NetWorker Command Reference Guide* or the UNIX man pages provide more information on the **nsrls**, **nsrck**, and **nsrim** commands.

Cannot use the Console interface to stop the savegrp command

If you start the **savegrp** command at the command prompt, and then attempt to stop the backup from the Console window, this message appears:

```
Only automatically started groups that are currently running can be
stopped
```

Manually stop the **savegrp** process.

Aborting a recovery

When you stop a recovery in progress on a client, the following could occur:

- ◆ The recovery might stop immediately.
- ◆ The files that still need to be recovered are listed.
- ◆ Messages similar to this might appear:

```
Recover: ***Canceled***
Recover: Unable to read checksum from save stream
Recover: error recovering C:\WINDOWS\CURSORS\APPSTART.ANI
Didn't recover requested file C:\WINDOWS\CURSORS\APPSTART.ANI
```

The messages indicate that a recovery was not stopped cleanly.

RPC error

If NetWorker has trouble backing up a directory path, a message similar to this appears, which notes the path:

```
* jupiter:E:\ save: xdr of win32 attributes failed for 'E:\PROGRAMS\'
```

The rest of the save set completes successfully.

To solve this problem, perform another backup of the directory.

Error message when relocating data

If you attempt to relocate data to a directory that does not exist, this error message appears:

```
Cannot create directory directory
```

Ignore this message. The recovery creates the new directory and completes successfully.

Desktop heap size limitation

Microsoft Windows XP has a set desktop heap size limitation that might produce the following error message when exceeded:

```
The application failed to initialize properly
```

The Microsoft Knowledge Base article 142676 on the Microsoft website provides information about this problem and how to correct it.

Other failures can also cause the desktop heap size to be exceeded. If this occurs, it is usually the result of numerous NetWorker processes that are running simultaneously. To determine the number of NetWorker processes that are running on the server, use the Windows Task Manager.

These conditions can cause the NetWorker server to exceed the desktop heap size limit:

- ◆ Large number of system services are running as Local System.
- ◆ More than 30 backup devices exist on the NetWorker server.
- ◆ NetWorker parallelism is set above 30.
- ◆ Performing more than 15 simultaneous recoveries.

If any of these failures occur, or if the “Application failed to initialize properly” message appears, increase the desktop heap size for system services. To do this, modify the third parameter to SharedSection as outlined in Microsoft Knowledge Base article 142676 on the Microsoft website. Increasing the size by 3072 usually corrects the problem. For example:

```
%SystemRoot%\system32\csrss.exe ObjectDirectory=\Windows
SharedSection=1024,3072,3072 Windows=On SubSystemType=Windows
ServerDll=basesrv,1 ServerDll=winsrv:UserServerDllInitialization,3
ServerDll=winsrv:ConServerDllInitialization,2 ProfileControl=Off
MaxRequestThreads=16
```

The All save set and duplicate drive serial numbers

The All save set, which backs up all locally mounted drives as well as the SYSTEM and VSS SYSTEM save sets, uses the serial numbers assigned to drives as part of its logic to determine if a drive should be backed up. It is possible for local drives to use the same serial number. In this case, the All save set results in only one of the drives being backed up.

If you encounter this problem, there are two possible solutions:

- ◆ Use the DiskProbe utility to set the serial numbers to unique numbers. The DiskProbe utility is part of the Windows Support Tools and is available for all versions of Windows supported by NetWorker software.
- ◆ Avoid using the All save set. Instead, specify each drive letter and SYSTEM or VSS SYSTEM save set separately. [“Scheduling predefined save sets for backup” on page 61](#) provides more information about the All save set.

Disk label errors

If a nonoptical device was configured as an optical device, this error message appears:

```
No disk label
```

Verify that the Media Type attribute in the Device resource matches the expected media for the device, and correct if necessary.

Cannot print bootstrap information

If the server bootstraps do not print, enter the printer's name when configuring the Group resource:

1. In the **Administration** window, right-click the group and select **Properties**.
2. In the **Printer** attribute of the **Setup** tab, enter the name of the printer where the bootstrap is to print.

Server index not forced

If the NetWorker server belongs to a group that is disabled or if it does not belong to any group, the **savegrp** program does not back up the NetWorker server.

The information to recover server indexes is stored in the media database on the NetWorker server.

Note: The **savegrp** no longer performs a server index backup for servers not in an active group.

Copy violation

If NetWorker software is installed on multiple servers and the same NetWorker enabler code was used for them all, messages similar to this appear in the save group completion email:

```
--- Unsuccessful Save Sets ---
* mars:/var save: error, copy violation - servers 'jupiter' and
  'pluto' have the same software enabler code, 'a1b2c3d4f5g6h7j8'
  (13)
* mars:/var save: cannot start a backup for /var with NSR server
  'jupiter'
* mars:index save: cannot start a backup for /usr/nsr/index/mars with
  NSR server 'jupiter'
* mars:index save: cannot start a backup for bootstrap with NSR server
  'jupiter'
* mars:index save: bootstrap save of server's index and volume
  databases failed
```

To successfully rerun the backup:

1. Issue the **nsr_shutdown** command on each server.
2. Remove the NetWorker software from the extra servers.
3. Restart the NetWorker services on the server where the backups are to go.

Xview errors

If this error message appears when you attempt to start NetWorker client graphical interfaces (for example, **nwrecover**), it means that the client is not authorized to display NetWorker graphical interfaces:

```
Xlib: connection to "mars:0.0" refused by server
Xlib: Client is not authorized to connect to Server
Xview error: Cannot open display on window server: mars:0.0 (Server
  package)
```

To correct the situation, configure the client to display the graphical interfaces:

1. From the client machine, invoke the **xhost** command:

```
xhost server_name
```

2. Remotely log in to the NetWorker server and issue the **setenv** command:

```
setenv DISPLAY client_name:0.0
```

For command shells other than **cs**h type:

```
DISPLAY=client_name:0.0  
export DISPLAY
```

Converting sparse files to fully allocated files

The NetWorker server determines that files are sparse by comparing the allocated blocks with the byte size. If the allocated blocks do not account for the size of the file, the file is considered to be sparse and is saved such that long strings of zeroes are replaced with “holes” in the recovered file.

When you use the HP Tru64 Advanced File System (AdvFS) clone filesets, AdvFS reports the number of blocks allocated to the clone (which is zero, or the number of blocks on the real file that have been modified since the clone creation). Thus, files in a cloned fileset always look sparse to the NetWorker server.

Some files that were not sparse when saved might be recovered as sparse. Oracle databases are susceptible to this problem because they are zero-filled, fully allocated files and are not sparse.

To workaroud this issue, use the **cp** command to copy the file after recovery:

```
cp recovered_filename zero_filled_filename
```

This converts a sparse file to a fully allocated file.

Note: To perform this workaroud, have enough free disk space to accommodate a duplicate of each sparse file that is copied.

Backing up large sparse files

To conserve backup media, sparse files are compressed before being written to tape. During this time, the backup job may stop with this message:

```
savegrp: Aborting inactive job (633).
```

This can occur because no data is being written to the backup media while the sparse file is processed. Increase the Inactivity Timeout attribute for the backup group.

To help determine an adequate timeout limit:

1. Set the **Inactivity Timeout** value to zero. A value of zero results in no timeout limit.
2. Determine the time required to complete a full save of the file system.
3. Use this time as the inactivity timeout limit. [“How to edit a group” on page 134](#) provides information about setting the inactivity timeout attribute for the group.

The mminfo -N command is case-sensitive regarding save set names

When querying the media database by using the **mminfo** command, the **-N name** option is case-sensitive. The save set name the **-N** option references must match the case of the save set name entered in the Client resource.

However, when backing up drive partitions on Microsoft Windows (for example, C:\), the NetWorker server stores the save set name in uppercase in the media database.

For example, if the save set name that represents the drive partition was entered in the Client resource in lowercase, you must query by using uppercase:

```
mminfo -N C:\
```

Renamed directories and incremental backups

If the name of a directory is changed after a full backup, but no files or subfolders in the directory were changed, the renamed directory is not included in subsequent incremental backups.

To avoid this issue, select the Backup renamed directories attribute on the Client resource.

Resolvable names for multiple network interface cards

If any component of NetWorker (client, storage node, server) has multiple network interface cards (NICs) with unique IPs and hostnames, all NICs must be configured and must be resolvable names, even if one or more NICs are not being used. Failure to have all NICs resolvable may cause problems with host connectivity to the NetWorker server.

Follow these steps to configure NetWorker so that the appropriate hostname is used for the associated IP, and to ensure the hosts file and routing table on the machine are configured properly:

- ◆ Set up DNS so that a separate name is associated with each IP
- ◆ Configure the hosts file and routing table on each machine that has multiple interfaces with the appropriate IP
- ◆ Configure NetWorker to use the names configured in steps 1 and 2.

Example for configuring multiple NICs

In the following example, a dual-interface client connects to the NetWorker Server and Storage Node over **interface1** having IP **1.1.1.1** and has a dedicated connection to the Storage Node over **interface2** having IP **2.2.2.1**. The user wants to send all data to the Storage Node over **interface2** instead of the default **interface1**.

1. Configure DNS with unique hostnames for IPs **1.1.1.1** and **2.2.2.1**. For example, **client-1** maps to **1.1.1.1** and **client-2** maps to **2.2.2.1**. DNS should also be configured with unique hostnames for the IPs on the Storage Node. For example, **node-1** maps to **1.1.1.2** and **node-2** maps to **2.2.2.2**.
2. Configure the routing table on the client to route the traffic through the correct interface, and add the two IPs to the local hosts file.
3. In NetWorker, enter **node-2** in the Storage Node Affinity List of the client.

Libraries entering ready state

When starting NetWorker or after configuring a library, it may take a short amount of time for the library to enter the Ready state within NetWorker. This is normal behavior.

Improper font size for the Client Wizard with Netscape on Solaris

When using the Netscape browser on Solaris, the font size of the Client Wizard may be too small.

To change the font type and size:

1. Open the `/usr/bin/nwwiz` script in a text editor.
2. Edit the following line to change the font size:

```
NSR_WIZARD_FONT_SIZE=size
```

3. Save and close the `nwwiz` file.

Successful save sets listed as failed in the Group Backup Details window

Certain backup operations, such as the direct SCSI feature and some NetWorker modules, create multiple sessions during a single backup job. If one of these sessions fails, the Console will report the entire backup job as having failed.

To determine the status of each session, click the **Show Messages** button in the Failed table of the **Savegroup Completion** dialog. This information is also available in the **Logs** tab, under monitoring, and in the savegroup completion report.

The NetWorker Server window does not appear on HP-UX

On HP-UX, the following error message appears if the **RPC ping via UDP when connecting to NetWorker** check box is selected in the NetWorker Console **Setup > Systems Options** dialog box is checked and the NetWorker server window does not appear:

```
Unable to connect to server: Failed to contact using UDP ping
```

To resolve this issue:

1. In the NetWorker Console, select **Setup**.
2. Select **Setup>System Options**.
3. Unselect the **RPC ping via UDP when connecting to NetWorker** checkbox.

Devices and autochangers

This section explains how to resolve problems with devices and autochangers.

Note: Device files and directories should not be edited. Editing these files can cause unpredictable behavior and make it impossible to recover data.

Additional attributes in the Autochanger resource

The Autochanger resource contains attributes that provide a detailed view of options that the `nsrjb` program uses. These are hidden attributes. [“Displaying diagnostic mode attributes” on page 663](#) provides information about displaying hidden attributes.

The *EMC NetWorker Command Reference Guide* or the UNIX man pages provide information about these attributes.

Note: Do not change time related attributes unless advised to do so by a Technical Support representative.

Maintenance commands

NetWorker device driver software provides maintenance commands, such as **lusbinfo** and **lusdebug**, for diagnosing problems on tape devices and autochangers.

The *EMC NetWorker Command Reference Guide* or the UNIX man pages provide information about these commands .

Autodetected SCSI jukebox option causes server to stop responding

If an autodetected SCSI jukebox is installed using **jbconfig**, and the server stops responding:

1. Select the **jbconfig** option that installs an SJI jukebox.
2. Enter the number that corresponds to the type of jukebox you are installing.
3. Proceed with **jbconfig** until this message appears:

```
Jukebox has been added successfully.
```

Autochanger inventory problems

These situations cause the autochanger inventory to become outdated:

- ◆ The media is manually ejected from the autochanger drive.
- ◆ The media is removed from the autochanger.
- ◆ The autochanger door is opened.

An outdated inventory means that the NetWorker software cannot use the autochanger.

To make the autochanger usable again:

1. Verify that the media cartridge is correctly installed in the autochanger and that the autochanger door is closed.
2. Log in as root or administrator on the NetWorker server.
3. Reset the autochanger by typing this command:

```
nsrjb -Hv
```

4. Perform an inventory by typing this command:

```
nsrjb -Iv
```

The NetWorker server can use the autochanger after the inventory operation completes.

[Chapter 3, "Configuring Libraries and Devices"](#) provides complete information on the use of the **nsrjb** command.

Destination component full messages

If a manual operation is performed on an autochanger, for example unloading the tape drive by using the buttons on the autochanger rather than by using the NetWorker server, this error message may appear:

```
Destination component full
```

To resolve the problem, use the `nsrjb -H` command to reset the autochanger.

Tapes do not fill to capacity

Tapes may not always be filled to capacity. For example, a tape with an advertised capacity of 4,000 MB can be marked full by the NetWorker server after only 3,000 MB of data have been written to it.

To use the tape to its fullest capacity, select the highest density device driver for the device. Reasons that the server appears to fill tapes prematurely include:

- ◆ Write errors occur during a backup.
 - With any tape error, the NetWorker server marks the tape as full.
 - To prevent tape write errors, clean the tape drive regularly and use only data-quality tapes. If cleaning the drive does not help, ensure that:
 - The device driver is properly configured.
 - Any necessary switch settings on the tape drive are set to the manufacturer's specifications.
 - All cables are secure.
 - Other potential SCSI problems have been addressed.
- ◆ NetWorker filemarks consume space on the tape.
 - The NetWorker server periodically writes filemarks to facilitate rapid recovery of data. These filemarks consume varying amounts of tape depending on the type of tape drive.
 - The number of filemarks the server writes to tape depends on how many save sets are on the tape. Many small save sets require more filemarks than a few larger ones.
- ◆ Tape capacities vary.

Two apparently identical tapes from the same vendor can vary significantly in capacity. This can cause problems if you copy one full tape to another, especially if the destination tape holds less data than the source tape.
- ◆ Data compression affects the tape capacity.
 - If you use compression on the tape drive, you cannot predict the effect on tape capacity. A compressing drive can provide twice the capacity of a noncompressing drive.
 - The capacity could vary depending on the type of data being backed up. For example, if a noncompressing drive writes 2 GB of data to a specific tape, the compressing drive could write 10 GB, 2 GB, 5 GB, or some other unpredictable amount of data.
- ◆ Length of tape. Verify tape lengths. A 120-meter DAT tape holds more data than a 90-meter DAT tape.

Tapes get stuck in drive when labelling on Linux Red Hat platform

When labeling a tape in a DDS configuration using a NetWorker server that is running Linux Red Hat, the tape may become stuck in the drive and display the following error message:

```
unload failure-retrying 30 seconds
```

To prevent a tape from being stuck in the drive, set the `auto_lock` setting to "0" (Off) in the `/etc/stinit.def` file for these drive types:

- ◆ Sony AIT-2 and AIT-3
- ◆ IBM LTO Gen1
- ◆ HP LTO Gen1
- ◆ IBM LTO GEN2
- ◆ IBM 3580 drive LTO-1
- ◆ IBM 3592 J1A
- ◆ Quantum DLT 7000

By default the `auto_lock` setting is set to 1 (On).

Increasing the value of Save Mount Time-out for label operations

A label operation may take more than 30 minutes before it fails under these conditions:

- ◆ Automeia management is enabled and a backup is initiated, and
- ◆ The NetWorker software encounters a corrupted tape during label operations.

The NetWorker software keeps a record of the location of the corrupted tape only for the current backup operation, so a corrupted tape could be used again for the next backup operation if the operator does not remove it.

To increase the value of the Save Mount Time-out attribute to 60 minutes from the default 30 minutes:

1. In the Administrator program, select **Devices** from the Media menu to open the **Devices** window.
2. From the **View** menu, select **Details** to display the hidden attributes.
3. Set the **Save Mount Time-out** attribute to 60 minutes.

Server cannot access autochanger control port

The control port controls the autochanger loading mechanism. The autochanger hardware installation manual contains information about how to verify whether the control port is properly connected.

If you cannot determine whether the control port is working, contact the autochanger vendor for assistance.

Modifying the control port

A change in the control port of the robotic arm of a library is characterized by the inability to perform library operations, such as labeling, mounting and unmounting, and inventorying. You may see the error "no such file or directory."

To update the NetWorker to use the new control port:

1. Run the **inquire** command to determine the SCSI device address of the library arm and to confirm that a serial number is reported. If a serial number is not reported go to [step 5](#).

IMPORTANT

Use the inquire command with caution. Running inquire sends the SCSI inquiry command to all devices detected on the SCSI bus. Using inquire during normal operations may cause unforeseen errors and possible data loss may result.

2. If the serial number of the arm is reported, follow the procedure at [“Scanning for libraries and devices” on page 110](#) to scan the library for devices.

3. Click **Monitoring**, then click to **Logs** tab and locate the message:

```
media info: The control port of the disabled library 'library_name' has
  been changed to 'scsidev@b.t.l' on storage node 'storage_node_name'!
```

4. Enable the library

- a. In the **Administration** window, click **Devices**.

- b. Expand the Libraries folder and right-click the library and select **Enabled/Disable**.

5. If the serial number was not reported in [step 1](#), or if scanning for devices does not detect the control port change, use the **nsradmin** command to change the control port:

- a. Log in as root or as Windows administrator on the NetWorker client.

- b. Enter the **nsradmin** command at the command-prompt. The **nsradmin** prompt appears.

- c. Disable the library by typing the following at the **nsradmin** prompt:

- type: **NSR jukebox**
- update enabled: **no**
- When prompted to update the resource, type **yes**.

- d. Update the control port by typing the following at the **nsradmin** prompt:

```
update control port: scsidev@b.t.l
```

where *b.t.l* is the bus.target.lun of the library's robotic arm (as reported by the **inquire** command).

When prompted to update the resource, enter **yes**.

- e. Reenable the library:

- update enabled: **yes**
- When prompted to update the resource, enter **yes**.

- f. To verify that the control port was changed and the library is now enabled, enter **print** at the **nsradmin** prompt.

Nonrewinding device requirement

Use a nonrewinding device for NetWorker backups. The NetWorker server writes a filemark on a volume at the end of each backup. When the next backup occurs, the server appends data to the volume based on the position of the filemark. If the device automatically rewinds the data, the filemark position is lost and the data is overwritten by the next backup.

Scanner command behaves differently with adv_file type device

The **scanner** command behaves differently when used with an advanced file type device.

When both primary and `_AF_readonly` `adv_file` type devices are unmounted, the following command results in the `_AF_readonly` device being mounted:

```
scanner -m -S ssid primary_device_name
```

This is expected behavior.

Sleep times required for TZ89 drive types

If you are unloading a TZ89 drive and receive the following error, your drives require changes to the sleep attributes in the Autochanger resource.

```
nsrd: media info: unload retry for jukebox `COMPAQTL895' failed - will
retry again.
```

To change the sleep attributes:

1. Shut down NetWorker services.
2. Shut down and restart the autochanger with the TZ89 drives.
3. When the autochanger is back online, restart NetWorker services. This resets NetWorker so that it stops trying to unload the drive.
4. Use these settings for the sleep time attributes:
 - Eject Sleep: **18** secs
 - Unload Sleep: **40** secs
 - Load Sleep: **40** secs

[“Additional attributes in the Autochanger resource” on page 679](#) provides information about setting the sleep attributes.
5. Attempt to unload the drive again. If the drive fails to unload, repeat this procedure and increase the sleep times.

Managing optical drives with Solaris 9

With Solaris 9, the Volume Management daemon (**vold**) is changed so that it automatically attempts to manage all removable media devices. Because of this change, the Volume Management daemon may interfere with NetWorker operations related to optical drives.

To resolve this possible conflict, disable the **vold** daemon *or* modify the daemon configuration file.

Disable the vold daemon

To disable the volume management (**vold**) daemon:

1. Log in as **root** on the NetWorker storage node, and remove or rename the `/etc/rc2.d/*volmgt` script.
2. Enter the `/etc/init.d/volmgt stop` command.

Modify the daemon configuration file

To modify the daemon configuration file:

1. Log in as **root** on the NetWorker storage node, and open the daemon configuration file, `/etc/vold.conf`, in a text editor.
2. Comment out this line in the **Devices to Use** section.

```
use rmcscli drive /dev/rdisk/c*s2 dev_rmcscli.so rmcscli%d
```

After commenting out this line, the **Devices to Use** section of the configuration file looks similar to this:

```
# Devices to use
# use rmescsi drive /dev/rdsk/c*s2 dev_rmescsi.so rmescsi%d
```

3. Save the configuration file.
4. Reinitialize the **Volume Management** daemon with the new configuration file settings. One way to do this is to send a hang-up signal to the daemon, for example:

```
ps -ef | grep vold
kill -HUP vold_pid
```

where *vold_pid* is the process ID of the volume management daemon, **vold**.

Message displayed when CDI enabled on NDMP or disk FTD

If the CDI feature is enabled while using an NDMP tape device or file type device (FTD), a message similar to this appears in the NetWorker message log:

```
nsrd: media notice: The CDI attribute for device "/dev/rmt/3cbn" has
been changed to "Not used".
```

To avoid this message, do not enable the CDI attribute for these device types.

Verifying firmware for switches and routers

If switches or routers are used, make sure that any switch or router firmware on the network was manufactured after August 1995 to ensure that RPC traffic is handled properly. Most of the switch and router vendors have significantly improved their handling of RPC traffic since August 1995.

Commands issued with nsrjb on a multi-NIC host fail

Commands may fail when issued to a NetWorker server or storage node that has multiple network interface cards (NIC).

To prevent this failure, add the domain name of each additional NIC to the **Aliases** attribute in the **Client** resource that is set up for the NetWorker server or storage node. [“Editing a client” on page 470](#) provides information about editing a Client resource.

SCSI reserve/release with dynamic drive sharing

When the NetWorker software uses Dynamic Drive Sharing (DDS) there is a possibility that the operating system's tape driver might use the SCSI reserve/release feature in a manner that interferes with the proper operations of the NetWorker software. This may require that reserve/release be disabled.

To disable the reserve/release feature for the various operating systems:

Solaris

SCSI reserve/release is configurable as a bit setting in the *st.conf* file for each device type in use. The Tape Configuration section of the *st* man page provides more information. Use the most up-to-date *st* driver that is available for the version of Solaris.

Edit the `st.conf` file *only* if one of the following conditions apply:

- ◆ DDS is used with the NetWorker software.
- ◆ A tape drive is used that is not supported directly by a Solaris `st` tape driver.

To determine if the tape drive is supported directly by a Solaris `st` tape driver, load a tape in the drive and enter the `mt` command. For example, with the tape device file `0cbn`, type the following:

```
mt -f /dev/rmt/0cbn status
```

If the output of the `mt` command includes the line `SCSI tape drive` or appears similar to the following, the `st` tape driver is using generic settings for that drive and it is *not* natively supported:

```
mt -f /dev/rmt/4cbn status
Vendor 'IBM      ' Product 'ULT3580-TD2      ' tape drive:
sense key(0x6)= Unit Attention  residual= 0
      retries= 0 file no= 0   block no= 0
```

If this configuration is used with the NetWorker software, the process might appear to work, but there might be problems recovering any saved data.

If the output of the `mt` command appears similar to the following, the `st` tape driver recognizes the drive and is using correct internal settings:

```
mt -f /dev/rmt/0cbn status
HP Ultrium LTO tape drive:
sense key(0x0)= No Additional Sense  residual= 0
      retries= 0 file no= 0   block no= 0
```

The only reason to edit the `st.conf` file is if the drive is being used in a DDS configuration.

AIX

To reset the reserve/release setting on an AIX operating system:

1. Through the **SMIT** interface, select **Tapes** from the **Devices** menu.
2. Change the value for the **RESERVE/RELEASE** support attribute from **No** to **Yes**.

HP-UX

To reset the reserve/release setting on an HP-UX 11 operating system:

1. Change the `st_ats_enable` kernel variable to a value other than zero.
2. (Optional) Restart the computer to ensure the change was implemented.

Note: The reserve/release is a fixed setting in HP-UX 10.

Tru64

SCSI reserve/release is only available on version 5.1B and later.

Device ordering issues

[“Device ordering” on page 269](#) provides information about issues related to drive ordering, including how to determine if drive reordering has happened, and procedures to correct the problem.

Recovery of save sets from a VTL

Loading a tape to recover save sets after moving the tape from one VTL of a NetWorker server to a VTL of another NetWorker server

When it is required to load a tape to recover save sets after moving the tape from a VTL of the source NetWorker server to a VTL of a different NetWorker server, the following procedure provides information about how to load the tape prior to running the **scanner** command to restore the backed-up save sets to another NetWorker server, without requiring a NetWorker mount operation:

1. Ensure the destination VTL is the same model, has the same drive names and the same number of drives as the original VTL.
2. Check the inventory of the VTL in the destination NetWorker node
3. Run the **inquire** command to get the Control port of the VTL in the destination NetWorker node.
4. Run the **sjimm** command to load the tape to the corresponding drive of the destination NetWorker server.
5. Run the following command to determine the tape status:

```
mt -f <device> status
```

After ensuring that the tape has been moved to another VTL, run the **scanner** command to restore the backed up save sets.

NetWorker locale and code set support

NetWorker software does not support locales (defined by the operating system) or code sets that remap characters having special meaning for file systems. Depending on the file system, these special characters may include the slash (/), the backslash(\), the colon (:), or the period(.). De_DE.646 is an example of one unsupported locale.

NetWorker software might not function normally if the locale is changed. The previously existing indexes can become invalid.

Issues with fonts when using X servers on Linux

A number of issues exist in Linux X font support for non-english locales that may cause problems when displaying the **nwrecover** program. These problems may be resolved by switching to a different locale for the same language (for example, by using ja_JP.eucjp instead of ja_JP.utf8).

Resource database notes

With NetWorker release 6.2 and later, resource information resides in this structure:

```
<NetWorker_install_path>\res\nsrdb\00
.
<NetWorker_install_path>\res\nsrdb\09
```

Each resource is stored in a separate numbered file. As new resources are created (for example, Client, Group, or Pool resources), new files are added in these directories.

Note: Because Client resources are generally small, the NetWorker client (**nsrexecd**) continues to use the <NetWorker_install_path>\res\nsrla.res file.

Viewing resources

You can view all NetWorker resources through the Administration window.

Although you can view the contents of the new NetWorker resource files with a text editor, direct user edits are not supported.

The only supported access to the resource database is through either of the following:

- ◆ **nsradmin -s** *server*
- ◆ **nsradmin -d** *NetWorker_install_path\res\nsrdb*

If you inadvertently specify the wrong path with the **nsradmin -d** command, empty resource directories are created. If this occurs, delete the incorrect directories.

Repairing resource database corruption

Corruption of NetWorker resource database files can be caused by a power outage, operating system crash, or manual editing of the database. If the NetWorker server is unable to read the resource files upon startup, messages similar to these are written to the daemon log file:

```
nsrd: WARNING: NSR configuration database detected invalid
resource ...\00019803aa14713c89456b41
nsrd: Invalid resource saved at ...\00019803aa14713c89456b41
```

[“Viewing log files” on page 663](#) provides information about viewing log files.

The NetWorker server removes any invalid resource files from the nsrdb directory structure and places them in the dbg directory. The dbg directory is created only if resource database file corruption has occurred. If you encounter this problem, open the corrupt file with a text editor to determine which resource is corrupted. You can then re-create the resource using either the Console window or the **nsradmin** command.

After you inspect a corrupt resource file, delete it.

Note: If you do not know the cause of the resource file corruption, go to the EMC Powerlink website for technical assistance.

Network and server communication errors

This section provides general, UNIX and Windows network and communication issues that you may encounter in a NetWorker environment.

To help ensure successful communication between NetWorker clients and servers, each host configured in NetWorker must *not* have any invalid or inactive IP addresses stored in the hostname resolution service used (DNS, NIS, Active Directory, hosts file, and so on). Each address mapped to a host must have a configured network interface (NIC).

General issues

This section provides information that may be relevant for multiple platforms.

Unapproved server error

If an unapproved server attempts to contact a client to initiate a backup, this message appears:

```
client_name: server_name cannot request command execution
```

1. After installation, if the client is to accept backup requests from other NetWorker servers, add the NetWorker server names to the *servers* file.
2. Ensure the servers file on a client contains both the short name and the long name of the server to use to back up that client's data. For example, the servers file on a NetWorker client should contain these names for a NetWorker server named *mars* in the jupiter.com domain:

```
mars
mars.jupiter.com
```

3. In the Alias attribute of the Client resource, list both the short name and the long name, plus any other applicable aliases for each client.
4. The preferred method of editing the *servers* file is to run the NetWorker Setup program in maintenance mode and edit the Allowed Servers list. The *NetWorker Installation Guide* provides details.

Unapproved server error during client setup

If you add a Windows client to a UNIX NetWorker server, and the UNIX server hostname is not included in the Windows client's *servers* file, you might receive this error message:

```
client_name: saveset_name Host server_name cannot request command
execution
client_name: saveset_name 10/13/00 11:48:26 nsrexec: Host server_name
cannot request command execution
client_name: saveset_name Permission denied
```

Ignore the message, and continue to add the client to the UNIX server. To eliminate the message, add the UNIX server hostname to the servers file on the client after you finish adding the client to the UNIX server.

Server copy violation

Add all server aliases that are related to any additional network interfaces to the alias list of the NetWorker server.

If aliases are not recognized, the server may be disabled with this error:

```
nsrd: registration info event: server is disabled copy violation
```

Remote recover access rights

You can control client recover access through the Client resource. The Remote Access attribute displays the users that have recover access to the client's save sets. Add or remove usernames depending on the level of security the files require.

Note: If you enter a hostname or `host=hostname` in the Remote Access attribute, any user on that host is allowed to recover the client's files. To enter a username without specifying the host, enter `user=name`.

These users have permission to recover any files on any client, regardless of the users listed in the Remote Access attribute:

- ◆ Root
- ◆ Member of the Administrator group
- ◆ Members of a group with Change Security Settings rights

Other users can recover only files for which they have read permission, based on file permissions at the time that the file was backed up. Files recovered by a user other than root, operator, or the operator group are owned by that user.

Authentication fails due to duplicate hostnames

Authentication with the NetWorker server may fail if multiple NetWorker hosts share the same short name. For example, suppose hosts from two domains, *accounting.company.com* and *marketing.company.com*, are configured for backup on the same NetWorker server. However, each domain has a host named *jupiter*. In this case, authentication may fail when the second host named *jupiter* attempts to contact the NetWorker server.

To enable the host to authenticate to the NetWorker server:

1. On the NetWorker host that cannot authenticate, stop the NetWorker client service. [“Stopping and starting a NetWorker server, client, or storage node” on page 51](#) provides more information.
2. Delete the **nsrladb** database, which is located in *NetWorker_install_path\res\nsrladb*.

NetWorker server takes a long time to restart

If the NetWorker media management database is very large, the NetWorker server may take a long time to establish client connections when it is restarted. The reason is that a consistency check of the media management database is triggered when the server is restarted.

To reduce the size of the media management database, run the **nsrim -C** command. Be aware that this command may take a long time to run and that the NetWorker server will be unavailable during this time. Run the command when the NetWorker server is not busy.

[“Reducing media database size” on page 460](#) provides more information about reducing the media management database.

Firewall issues

If network communications are not functioning correctly, it may be related to incorrectly configured firewall rules on one or more of the hosts involved. Determine if a firewall is enabled and make sure that it is correctly configured to allow communications with NetWorker programs. [Appendix B, “Firewall Support,”](#) has information about firewall configuration.

1. Type this command:

```
nwinstcreate -n long_host_name
```

where *long_host_name* is the fully qualified host name, for example, *jupiter.accounting.company.com*. The *EMC NetWorker Command Reference Guide* or the UNIX man page provide more information about **nwinstcreate**.

- Restart the NetWorker client service. [“Stopping and starting a NetWorker server, client, or storage node” on page 51](#) provides more information.

The host can now authenticate by using the long name.

UNIX communication issues

This section covers communication issues on UNIX networks.

Troubleshoot IP errors

If any of these error conditions occur, there may be an IP naming problem:

- ◆ RPC errors
- ◆ Unknown host messages
- ◆ Failure contacting the portmapper
- ◆ Connection failures or timeouts
- ◆ Program unexpectedly exiting
- ◆ Refused connections
- ◆ Remote command (the `rcmd()` function) to active client failures
- ◆ Name-to-address translation failures
- ◆ Program not registered messages
- ◆ NetWorker services failing to start
- ◆ NetWorker services failing to remain active
- ◆ Invalid path messages

To troubleshoot IP errors:

- Document the steps you take and the results, especially error messages, in case you need to contact EMC Technical Support. This enables you to email or fax the steps and error message to EMC.
- Set up a host table for each NetWorker client and NetWorker server. [“Setting up a host table” on page 691](#) provides details.
- Disable other name servers to simplify testing. [“Disabling the DNS server” on page 692](#) provides details.
- Use **ping** to establish basic connectivity. [“Using ping to verify network connections” on page 693](#) provides details.
- Use **rpcinfo** to verify that sessions can be established and that portmapping is correct. [“Using rpcinfo to verify that sessions can be established” on page 693](#) provides details.

Setting up a host table

Troubleshoot IP problems by using only the host table. Troubleshooting by using only the host table does not mean you cannot use a name service, for example, DNS, with NetWorker software. Run tests by using only the host table to determine whether you have the software installed correctly. After you know the software works with the host table, enable the name server.

To set up a host table:

1. On the NetWorker client, list the client and the NetWorker servers to which it connects, for example:

```
127.0.0.1 localhost loopback
123.456.789.111 client client.domain.com
123.456.789.222 server server.domain.com
```

2. On the NetWorker server, list the NetWorker server and all of its clients, for example:

```
127.0.0.1 localhost loopback
123.456.789.111 server server.domain.com
123.456.789.222 client client.domain.com
```

Ensure the first alias entered for the NetWorker server matches exactly the current NetWorker server hostname.

3. Use the guidelines in [“Using ping to verify network connections” on page 693](#) to ensure the highest success rate for parsing a host table within any operating system.

Recommendations for host table configuration:

- ◆ Do not use blank lines in the body of the host table.
- ◆ The end of the host table should always contain a blank line.
- ◆ The first un-remarked entry should always be the loopback line in the exact order and format shown in [step 1](#) and [step 2](#).
- ◆ The last character of each unremarked line should be a space, not a carriage return.

On UNIX platforms, the host table resides in the `/etc/hosts` file.

Disabling the DNS server

To simplify the troubleshooting of hostname resolution problems, disable services like DNS, DHCP, and Windows Internet Naming Service (WINS).

Disable DNS just for the initial setup of the NetWorker clients and the NetWorker server to be tested. Only disable the ability of a client to obtain IP naming information from a DNS server.

To disable the DNS server on most UNIX platforms, rename the file `/etc/resolv.conf` and reboot. Alternatively, set up the IP name search order so that the host table is searched before DNS.

Note: If the hostname cannot be resolved, the NetWorker server caches this information for five minutes before attempting the resolution again. If the hostname is successfully resolved, the information is cached for 30 minutes.

Setting the IP name search order

To set the IP name search order:

1. Edit the `/etc/nsswitch.conf` file and verify that the `/etc/resolv.conf` file exists.
2. Set the host file to be first in the search order, with DNS second and NIS last. For example:

```
hosts: files [NOTFOUND=continue] DNS [NOTFOUND=continue] nis
```

For an AIX system, edit the `/etc/netsvc.conf` file and reboot.

You can also set the NSORDER environment variable. The InfoExplorer program provides instruction on specific versions of AIX.

Using ping to verify network connections

After you create the host table, test it using **ping**.

On the NetWorker client, **ping**:

- ◆ Client short name (hostname) from the client
- ◆ Client long name (hostname plus domain information) from the client
- ◆ Client IP address from the client
- ◆ Server short name from the client
- ◆ Server long name from the client
- ◆ Server IP address from the client

This example shows how to **ping** the client short name and client long name from a NetWorker client called *mars* in the *jupiter* domain:

```
ping mars
ping mars.jupiter.com
```

On the NetWorker server, **ping**:

- ◆ Server short name from the server
- ◆ Server long name from the server
- ◆ Server IP address from the server
- ◆ Client short name from the server
- ◆ Client long name from the server
- ◆ Client IP address from the server

Using rpcinfo to verify that sessions can be established

If **ping** is successful and backup problems still exist, test with **rpcinfo**. Use **rpcinfo** to test the operation of the portmapper. Use the same tests with **rpcinfo** as with **ping**.

To use **rpcinfo**, the host whose hostname you enter must have a portmapper running. In most cases, EMC portmappers are compatible with third-party portmappers. If you are using a product that provides its own portmapper, do not load the third-party portmapper until you have verified that the NetWorker software works with the rest of the environment.

On Solaris, the **rpcbind** service must be running. On AIX and HP-UX, the **portmap** daemon must be running. The **rpcinfo** utility is part of the operating system.

The syntax for using **rpcinfo** to display ports using TCP is:

```
rpcinfo -p hostname
```

Substitute the long name and short name for the variable *hostname*.

View other **rpcinfo** options by typing **rpcinfo** at the command-prompt. The UNIX man page provides more information. Repeat **rpcinfo** using all the locations and all the iterations listed in this document for **ping**.

When **rpcinfo** runs successfully, the output is a list of port numbers and names. For example:

```
rpcinfo for mars
program vers proto  port
```

```

100000 2 tcp 111 portmapper
100000 2 udp 111 portmapper
390103 2 tcp 760
390103 2 udp 764
390109 2 udp 764
390107 4 tcp 819
390107 5 tcp 819
    
```

Binding to server errors

NetWorker architecture follows the client/server model, where servers provide services to the client through the RPC. These services reside in daemon processes.

When the daemons start, they register with the registration service provided by the portmapper.

If the NetWorker services are not running and a NetWorker service is requested, this messages appear in the savegroup completion email:

```

Server not available
RPC error, no remote program registered
    
```

These messages indicate that the NetWorker services **nsrd**, **nsrexecd**, **nsrindexd**, **nsrmmmd**, and **nsrmmdbd** might not be running.

Table 113 NetWorker Startup commands

Operating system	Startup command
Solaris, Linux, IRIX	/etc/init.d/networker start
HP-UX, HP Tru64 UNIX	/sbin/init.d/networker start
AIX	/etc/rc.nsr

Saving remote file systems

This error messages might appear in the save group completion email when a backup for a remote client fails:

```

Host hostname cannot request command execution
hostname: Permission denied
    
```

The first message means that the **nsrexecd** service on the client is not configured to allow the server to back up its files. The second message means that the **nsrexecd** service is not currently running on the client.

To resolve these problems, ensure that the **nsrexecd** service is running on the client and that the server’s hostname is listed in the boot-time file. The boot-time file lists all the servers, in order of precedence, that can contact a client for backups.

[Table 114](#) lists the location for the boot-time file. The **nsrexecd** man page provides information about **nsrexecd**.

Table 114 Boot-time file locations

Operating system	Boot-time file
AIX	/etc/rc.nsr
HPUX	/sbin/init.d/networker
IRIX (SGI)	/etc/rc2.d/S95networker
SCO	/etc/rc2.d/S95networker
Solaris	/etc/init.d/networker
SunOS 4.1.x	/etc/rc.local
Ultrix	/etc/rc./local
Others	/etc/rc2.d/S95networker

Microsoft Windows communication issues

This section covers communication issues on Windows networks.

Certified protocols

This release of NetWorker software has been tested and is certified to work on Microsoft TCP/IP. Other protocols, such as Novell IPX/SPX, Microsoft IPX/SPX, and Microsoft Proxy Client, are not certified to work with NetWorker software at this time.

Resolving connection problems

This section addresses DNS and local host file related connection problems and solutions.

During installation, this error message might appear after an apparently successful client-server connection.

```
hostname is not a valid hostname.
```

This type of error message indicates possible problems with hostname resolution. This section notes items to check when you encounter connection problems.

IP configuration

If you experience IP configuration problems:

- ◆ If you are using DNS, ensure the IP address of the Windows computer is correct.
- ◆ If you are not using DNS, ensure the host table is set up correctly.
 - The host table is in the hosts file located in %SystemRoot%\system32\drivers\etc
 - Ensure that the hostname is set correctly.
 - Check the host table on both the server and client computers. Check that all hostnames, fully qualified domain names, and IP addresses are listed.
 - Both server and client hostnames should be in the host table with the IP address, short names, and long names:

```
Server A Host Table
127.0.0.1localhostloopback
xxx.xxx.xxx.xxxserver_aserver_a.domain.com
xxx.xxx.xxx.xxxclient_a client_a.domain.com
Client A Host Table
127.0.0.1localhostloopback
xxx.xxx.xxx.xxxclient_aclient_a.domain.com
xxx.xxx.xxx.xxxserver_a server_a.domain.com
```

- Ensure the first alias entered for the NetWorker server matches exactly the current NetWorker server hostname.

To ensure that the computer returns the correct hostname:

1. In the **Control Panel**, access the dialog box for DNS configuration.
2. Enter the hostname in the **Hostname** text box.
3. Edit the domain name in the **Domain Name** text box. The hostname and the domain name together make up the fully qualified domain name.
4. To ensure that TCP/IP is set up correctly, check the hostname and fully qualified domain name by typing this at the command-prompt:

```
ipconfig /all
```

ping hostname**Domain Name Server**

If you experience DNS problems, ensure that:

- ◆ The DNS server address is correct.
- ◆ The DNS server is running.
- ◆ The default gateway is set up correctly.
- ◆ DHCP is set up correctly. If you are using DHCP, the NetWorker server must have a reserved IP address.

Connectivity

If you experience connectivity problems, ensure that:

- ◆ The Windows computer can **ping** its destination using both the destination's hostname and its fully qualified domain name.
- ◆ The Windows computer can **ping** itself using both its hostname and its fully qualified domain name.

NetWorker software

If you experience NetWorker software problems, ensure that:

- ◆ You are using the **-s server** argument when starting a NetWorker utility from the command prompt.
- ◆ There is a space in the path for the **-s server** argument or the path to the NetWorker program.
- ◆ The NetWorker server to which you are connecting is running.

Tips

These tips can help prevent problems using the NetWorker software:

- ◆ Use the host table instead of DNS to test if DNS is working properly.
- ◆ Eliminate DHCP and use a static IP address instead.
- ◆ Use the 8.3 file naming convention for directory names in a path. Do not include spaces in pathnames.

Changing the NetWorker server address

When the TCP/IP address changes on the NetWorker server, the NetWorker host ID also changes, which invalidates the authorization code. In this case, reregister the software. To reregister the software, print out the registration form with the new host ID and return it to EMC Customer Service. If you do not reregister the software within 14 days, the NetWorker software stops working.

If you are using DHCP, use a static IP address for the NetWorker server.

New.Net and NetWorker software are incompatible

Software from New.Net, Inc. loads a dynamic link library (DLL) named `newdotnet.dll`, which modifies the Windows TCP/IP stack in ways that are incompatible with NetWorker software. This causes many NetWorker programs, including `save.exe`, to fail on exit. This is a New.Net problem that NetWorker software cannot work around. New.Net software is included in products such as Go!Zilla, BearShare, Mp3.com, iMesh, Babylon, Cydoor, Webshots, and gDivx.

If you suspect that the New.Net DLL is the cause of problems, search for the `newdotnet.dll` file on the system drive. If you find this file, uninstall the New.Net software.

Note: Do not manually delete the `newdotnet.dll` file. Doing so renders the system unusable.

Troubleshooting port configurations

The following error messages might appear if there are problems with port configurations:

- ◆ Cannot bind socket to service port in configured range on system *hostname*

This indicates that the configured service port range is not large enough.

To resolve this problem:

1. Increase the service port range configured for the specified hostname.
2. Set the firewall rules to allow inbound and outbound TCP/UDP packets within the port range specified in [step 1](#).

- ◆ Cannot bind socket to connection port in range on system *hostname*

This indicates that the configured connection port range is not large enough. The current backup or recovery session has been stopped.

To resolve this problem:

1. Increase the connection port range for the specified hostname.
2. Set the firewall rules to allow inbound and outbound TCP/UDP packets within the port range specified in [step 1](#).

Conflicting portmappers

Portmappers used with Hummingbird Maestro and Exceed software earlier than version 5.1 conflict with the NetWorker portmapper. This conflict occurs because Maestro and Exceed software install a service named **HCL Inetd**. You cannot successfully install the NetWorker software while this service is running. You must disable the **HCL Inetd** service through the Services window in the Control Panel before installing the NetWorker software (the Maestro and Exceed software continue to run).

If you installed both the NetWorker software and the Hummingbird software and you have difficulties with portmappers, contact Hummingbird Technical Support.

NetWorker archiving and retrieval

This section explains how to troubleshoot issues with the Archive Module.

Remote archive request from server fails

If a remote archive request cannot be performed from the NetWorker server, the archive client's username (for example, `root`) might not be listed in that client's Archive Users attribute in the Client resource.

You can also grant NetWorker administrator privileges for `root@client_system` in the Administrator attribute in the Server resource. However, be aware that NetWorker administrators can recover and retrieve data owned by other users on other clients.

Multiple save sets appear as a single archive save set

When you combine multiple save sets in an archive, such as /home and /usr, they end up in a single archive save set. To retrieve archives separately, archive them separately.

Wrong archive pool is selected

If multiple archive pools exist, the last one created is selected for archive.

Second archive request does not execute

If you create two archive requests with the same name, only the first request is executed. Do not create two archive requests with the same name.

The nsrarchive program does not start immediately

If **nsrarchive** is run from the command-prompt, the archive will not start immediately. Wait a short time until the archive starts. Do not press [Ctrl]+[D] multiple times.

Archive request succeeds but generates error when nsrexecd is not running

During an archive request operation, an error is generated when **nsrexecd** is not running on a remote client. The archive operations succeeds, but the following error message is logged to the daemon log file:

```
Failed to get port range from local nsrexecd: Service not available.
```

[“Viewing log files” on page 663](#) provides information about viewing log files.

Empty annotations in retrieve list

Older releases of the NetWorker Archive application software installed on DOS, Windows, and NetWare lack an annotation feature. As a consequence, the annotations for save sets archived with the older software are empty strings in the retrieve list.

Storage nodes

This section provides troubleshooting information about storage nodes.

Storage node affinity errors

A storage node affinity problem may exist if a backup fails with this error message:

```
No matching devices; check storage nodes, devices or pools
```

Possible reasons include:

- ◆ No devices are enabled for the storage nodes.

- ◆ The devices do not have volumes that match the pool required by the backup request.
- ◆ All devices are set to read-only.

Fix the problem and restart the backup. Do one of the following:

- ◆ Enable devices on one of the storage nodes.
- ◆ Correct the pool restrictions for the devices listed in the Storage Nodes attribute.
- ◆ Add another storage node to the Storage Nodes attribute that has devices that are enabled and that meet the pool restrictions.
- ◆ Set one of the devices to read/write.
- ◆ Adjust the Save Mount Timeout and Save Lockout attributes for the storage node's Device resource.

Storage node timeout errors

If **nsrd** initializes on the server and detects that a setting for **NSR_MMDCONTROL** exists, this message appears:

```
NSR_MMDCONTROL env variable is being ignored
use nsrmmmd control timeout attribute instead
```

If you receive this message:

1. Shut down the NetWorker services.
2. Remove the environment setting for **NSR_MMDCONTROL**.
3. Restart the NetWorker services.
4. Start the Console server.
5. Adjust the value of the **nsrmmmd** Control Timeout attribute to the value previously assigned to the **NSR_MMDCONTROL** variable, or one that best meets the current requirements. [“Modifying timeout attribute for storage node operations” on page 100](#) provides more information.

Storage node communication errors

If the **nsrmmgd** process has not been added to the Windows firewall **Allow** list on the NetWorker server, a library configured on the NetWorker storage node will not enter “ready” state. Multiple **nsrlcpd** processes are started on the storage node, and the following error message appears in the **daemon.raw** file on the storage node:

```
Unable to obtain a client connection to nsrmmgd (version %u)
on host %s
```

If you receive this message, ensure that the firewall is turned on, then add the **nsrmmgd** process to the **Allow** list of the Windows firewall on the NetWorker server host.

Console error messages and corrective actions

Table 115 provides a list of Console error messages or symptoms and corrective actions to take.

Table 115 Error messages or symptoms (1 of 3)

Error message or symptom	Possible cause	Corrective action
If the Console server fails to load and instead displays a Save As... dialog box.	In Internet Explorer: Either the web browser's security level is set to High (disabling JavaScript, which is needed to launch the product), or JavaScript has been disabled by some other means.	In Internet Explorer: Lower the web browser's security setting or enable Active Scripting.
Authorization code not accepted.	NetWorker software temporary enabler code has already expired.	Log out, then stop and restart the Console server.
Application window is unresponsive.	Insufficient disk space on the file system where the Console database is installed.	<ul style="list-style-type: none"> Ensure that the Console server is running. “Console troubleshooting notes and tips” on page 704 provides details. If it is not, close all application windows and check the gstd log file for errors. “Viewing log files” on page 663 provides information about viewing log file. Back up and move the Console database, if necessary. On a Windows system, run InstallShield with the Repair option to move the database to a different drive.
	Application ran out of memory.	Close all instances of the application and restart it.
	Another dialog box is open in the Console window or Administration window.	Close any open dialog boxes or error messages.
Connection refused: no further information. or Problem contacting server <i>server_name</i> :	Console server is in the process of crashing or has already crashed.	Check to see if the Console server is running. <ul style="list-style-type: none"> If it is running, stop and restart the Console server. If it is not, close all application windows and check the gstd log file for errors. “Viewing log files” on page 663 provides information about viewing log files.
	Console server has been started within the previous few minutes.	Wait a couple of minutes and retry.
Failed to bind to port XXXX message in the gstd.raw log file.	The gstd service port (default 9001) is being used by some other process or is in a timeout (TIME_WAIT/FIN_WAIT) state.	Close any running NMC GUIs or any processes that may be using the gstd service port. Wait until the timeout period passes so that the operating system can free up the port. The timeout period may differ between operating systems.
Database fetch operation failed.	Console database is corrupt.	Recover the database. “Recovering the Console database” on page 340 provides details.

Table 115 Error messages or symptoms (2 of 3)

Error message or symptom	Possible cause	Corrective action
Display problem: In Internet Explorer: The page cannot be displayed.	Console server is not running.	Restart the Console server.
	Browser is not pointing to the correct URL.	Check the install log file to determine the HTTP port used by the Console server. “The install log” on page 703 provides details.
	Network connection is down.	Ping the Console server to confirm the network connection. If it is available, contact the system administrator.
Enabler code not accepted.	Temporary enabler code has expired.	1. Close the Console server and log in again. 2. Repeat the procedure of entering the enabler code. If the enabler code is still not accepted, log out, then stop and restart the Console server.
Database delete operation failed: Reference object does not exist.	Another user has already deleted that user or folder.	None
Database store operation failed: An object with pathname “ <i>pathname</i> ” already exists.	<ul style="list-style-type: none"> • Another user is trying to add a folder to the same location in the Enterprise at the same time. • An object was added with the same name as an existing object. 	<ul style="list-style-type: none"> • Wait a few moments and try again. • Check whether there is an existing object with the same name.
Invalid Object ID.	Another user deleted that host.	None
Could not contact License Manager on < <i>hostname</i> >. - or - Program not registered.	License Manager hostname has not been assigned or License Manager is not running or installed.	If you are using the License Manager and a hostname has not been assigned: <ol style="list-style-type: none"> 1. Select the Software Administration task. 2. Click Licensing. 3. Click Software Administration on the menu bar. 4. Click Change LLM Server. 5. Enter the new License Manager hostname. 6. Click OK. 7. If License Manager is installed, but not running, start it. <hr/> Note: The <i>NetWorker License Manager Installation and Administrator’s Guide</i> provides details.
	NetWorker client was stopped, but the License Manager was not stopped, and then the NetWorker client was restarted. Although both services are now running, NetWorker client must be started <i>before</i> License Manager is started. If the services are not started in the correct order, an error condition occurs.	<ol style="list-style-type: none"> 1. Stop the NetWorker software. 2. Stop License Manager if it is running. 3. Restart License Manager. 4. Restart the NetWorker software.
License allocation failed.	Temporary license for NetWorker software is expired.	Enter enabler codes and register the product.
License managed event indicates that license is expiring/expired even though it has been authorized.	License has been authorized within the last 24 hours.	None needed. To remove the managed event from the display, dismiss the event or it will be deleted within 24 hours.

Table 115 Error messages or symptoms (3 of 3)

Error message or symptom	Possible cause	Corrective action
Logging of debug messages has stopped. alloc /opt: file system full.	Disk space on the /opt file system is nearly depleted.	Allocate more disk space.
Event disappears from the Events window.	Another user dismissed it, or the problem that was causing the event no longer exists.	None
Dialog box: "Java Web Start –Download Error" with the message, "Unable to launch NetWorker Console".	<p>Java Web Start preferences are set to something that is incompatible with the rest of the environment.</p> <p>(For example, a proxy server has been set up that stops Java Web Start from downloading the Console client software from the Console web server.)</p> <p>This error message may also occur if the Console is being launched on a localized operating system and the Java Web Start cache path contains non-English characters.</p>	<p>Check the Preference settings in the Java Web Start Application Manager for compatibility with the environment. Change any settings that prohibit the download of the Console client software.</p> <p>(In the proxy server example, go to the General tab of the Preferences dialog box and select None, for Proxies.)</p> <p>If the Java Web Start cache path contains non-English characters, change the path to contain no non-English characters.</p>
<i>gstd.log</i> file error: internal error: could not end transaction	When the system time is moved ahead, a time out event is initiated and the database client connection for the gstd process is closed.	None

Console log files

The Console server produces these log files:

- ◆ install
- ◆ gstd
- ◆ db output
- ◆ dbstop output

The install log

Refer to install log files when doing one of the following:

- ◆ Troubleshooting a problem with the Console server.
- ◆ Tracking decisions made during installation, such as the HTTP service port chosen for the web interface.

By default, the install log files are located in /opt/LGTONmc/logs (UNIX) or C:\Program Files\Legato\Management\GST\logs (Microsoft Windows).

The gstd log

The gstd log file contains messages from the Console server. Whenever the Console server is restarted, the size of the gstd log file is checked. If the gstd log file has reached its maximum size, the Console server starts a new gstd log file.

The gstd log file is placed in these default locations:

- ◆ On UNIX/Linux: /opt/LGTONmc/logs
 - ◆ On Windows: %SystemDrive%\Program Files\Legato\Management\GST\logs
- “Viewing log files” on page 663 provides information about viewing log files.

Table 116 lists the variables that control the gstd.log file.

Table 116 Environment variables for the GSTD log

Variable name	Description
GST_MAXLOGSIZE	Sets the maximum size of the gstd log file before it is renamed on GST restart.
GST_MAXLOGVERS	Sets the maximum value of nnn in gstd.nnn.
GST_DEBUG	Sets the level of verbosity of the gstd log file. Can also be set from the System Options dialog box.

“Setting system options” on page 415 provides more information .

Console troubleshooting notes and tips

This section provides general troubleshooting tips for the Console server.

Making sure the Console server is running

If the Console server is not responding, answer the following questions:

- ◆ Is a potentially long-running process such as a device operation (label or inventory, for example) currently running?

Any process started on the Console server locks the user interface until that process completes. To perform multiple, long-running operations simultaneously (that is, to administer multiple NetWorker servers), open a separate instance of the Console server to run each operation.

- ◆ Are the following processes running?
 - GST server (**gstd**)
 - Database server (**dbsrv9**)
 - Web server (**httpd**)

These processes must be running to support the Console server.

- ◆ Is the **ntpdate** command synchronizing at midnight?

In some cases, having a cron job that has **ntpdate** synchronize at exactly midnight can cause the Console server to lose connection to the database. If such a situation occurs, modify the cron job to have **ntpdate** synchronize at some time other than midnight (12:00 A.M.) or have **ntp** run as a service and synchronize continuously.

How to determine if the Console server is running on a Windows system

On a Windows computer:

1. From the **Start** menu, select **Control Panel > Administrative Tools > Services**.
2. Verify that **EMC GST Service** is running.

How to determine if the Console server is running on a Solaris system

- ◆ To check whether the **gst** server process is running, enter this:

```
/usr/bin/ps -ef | grep gstd
```

If the **gst** process is running, a result similar to this appears:

```
root 6140 1 0 12:54:10 ?0:03 /opt/LGTONmc/bin/gstd
```

- ◆ To check whether the database process is running, enter this:

```
/usr/bin/ps -ef | grep dbsrv
```

If the database server is running, a result similar to this appears:

```
LGTONmc root6140 1 0 12:54:10 ?0:03
/opt/LGTONmc/sybase/bin/dbsrv9
```

- ◆ To check whether the web server process is running, enter this:

```
/usr/bin/ps -ef | grep httpd
```

If the web process is running, a result similar to this appears:

```
LGTONmc root6140 1 0 12:54:10 ?0:03 /opt/LGTONmc/bin/httpd
```

Enabling Java script

If JavaScript becomes disabled, the Console server will not launch. Check the web browser's settings and reenables JavaScript if necessary.

Note: The procedure for enabling a given browser's version of JavaScript might differ from the instructions shown here. If it does, consult the browser's Help application for information about enabling JavaScript on the browser.

Java Web Start jnlp file caching issue after upgrading the NetWorker Console

After the NetWorker Console is upgraded or a client locale is changed, the **gconsole.jnlp** file will be different than the original **gconsole.jnlp** file in the Java Web Start cache. The NetWorker console may fail to launch.

Workaround

Remove the NetWorker Management Console Application and Language Pack (if applicable) from the Java Cache Viewer:

1. Run the Java Cache Viewer. From the command line, use the **javaws -viewer** command to launch the application.
Two different windows are displayed on the screen.
2. In Java Cache Viewer window, select **Applications** in the **Show** drop-down list. Remove all instances of **NetWorker Management Console** from the table below.
3. In the **Show** drop-down list, select **Resources**. Remove all URL entries in the table that start with the text, *Error! Hyperlink reference not valid*.
4. Close the Java Cache Viewer window.

5. In the Java Control Panel window click **Settings**.
6. Click **Delete Files** and click **OK**.

Querying large numbers of save sets in the NetWorker user interface may cause a Java heap space error

Querying large numbers of save sets in the NetWorker user interface may fail with a Java heap space error.

Workaround

Increase the Java heap size used by the NMC application:

1. On the Console server host, open the gconsole.jnlp file in a text editor. The gconsole.jnlp file is located in:

```
Console_install_dir\web
```

2. Increase the default max-heap-size value from 700MB to 1400MB. For example,

```
<resources>
<j2se version="1.5+" initial-heap-size="64M"
max-heap-size="1400M" />
```

Note: To provide meaningful query results and to reduce the chance of encountering this error, narrow the save set search criteria by specifying selection parameters.

“Unable to connect to host” error in the Client Backup Configuration wizard

The following message may appear when attempting to complete tasks that use the remote agent:

```
Unable to connect to host: Please check Security setting and daemon
logs on the Networker client and Console server for more details
```

This message may appear when performing one of the following:

- ◆ Client Configuration wizard tasks
- ◆ Device Configuration wizard tasks
- ◆ Save set browsing when adding or modifying a client resource

Check for one of the following when you receive this error:

1. Verify that the SSL key matches between the NMC Server and the NetWorker client host. The SSL key is in the NSR Peer Information attribute, which is located in each host’s nsrladb database. A mismatch can occur when the nsrladb on one host is corrupted.

To resolve this issue, delete the Console Server’s NSR Peer Information from the NetWorker Client’s **nsrladb**, and delete the NetWorker Client’s NSR Peer Information from the Console Server’s **nsrladb** as following:

- To delete the Console Server’s NSR Peer Information from the NetWorker Client’s nsrladb, on the client host, type:

```
nsradmin -p nsrexec
nsradmin> print type:NSR peer information
```

Note: Identify the Console Server’s NSR Peer Information, and delete it.

```
nsradmin> delete type: NSR peer information;name:<Console Server
name>
Delete? Yes
```

- To delete the NetWorker Client's NSR Peer Information from the Console Server's nsrladb, on the Console Server host, type:

```
nsradmin -p nsrexec
nsradmin> print type:NSR peer information
```

Note: Identify the NetWorker Client's NSR Peer Information, and delete it.

```
nsradmin> delete type: NSR peer information;name:<Client name>
Delete? Yes
```

Note: After the deletion is complete, it is not mandatory to restart the NetWorker or Console services.

2. The Client cannot resolve hostname of NMC Server or NW Server. Sometimes, NMC can resolve the client hostname, but, client cannot resolve NMC or NetWorker Server hostname.

To resolve this issue, ping the NetWorker Server and NMC server from the Client. If the ping fails, DNS is not resolving the hostname issue and add the hostname to the client hosts file.

3. Ensure NetWorker users have at least the "Operate NetWorker" privilege to launch the Client Wizard. To resolve this issue, add the user to the appropriate user_group in the NetWorker Server.
4. The NetWorker Server may not be present in the client's servers file. To resolve this issue, add the NetWorker Server to the client's servers file.
5. The NMC Server, NetWorker Server and NetWorker client hosts must only use nsrauth authentication.

Username/password validation fails when using NMC New Device wizard to configure an AFTD if storage node is UNIX

When using the NMC New Device Wizard to configure an AFTD, username/password validation for browsing the file system may fail if the storage node is a UNIX host. This failure occurs if the system is missing the Pluggable Authentication Modules (PAM) library, or when the rule in the pam.conf file (/etc/pam.conf) for **OTHER service** is set to **deny**.

Perform the following if validation fails when using the New Device Wizard on a UNIX storage node:

1. Install the PAM package appropriate to your environment if it is not already installed.
2. Modify the pam.conf file so that the rule for **OTHER service** is not set to **deny**.

The operating system's documentation provides more information.

NMC user interface exits unexpectedly

If the NMC GUI loses its connection to the **gstd** service because the **gstd** service was shutdown or failed, the GUI will give a warning and exit after 10 seconds. This is normal behavior. [“Console error messages and corrective actions” on page 701](#) provides more troubleshooting information.

This appendix covers these topics:

- ◆ [SYSTEM save sets.....](#) 710
- ◆ [VSS SYSTEM save sets.....](#) 714

SYSTEM save sets

The SYSTEM save sets discussed in this section work with these operating systems:

- ◆ Windows XP Professional
- ◆ Windows Server 2003 32 and 64 bit (with no VSS client license, or with VSS disabled)

The SYSTEM save sets includes the System State, System Files, and System DB.

Components of the SYSTEM STATE save set

As part of the SYSTEM STATE save set, NetWorker software backs up all Windows system state components except the SFP component. [“Components of the SYSTEM FILES save set” on page 711](#) provides information about how NetWorker software treats the SFP component.

Certain basic system state components are present with every Windows Server 2003, or Windows XP Professional installation. These components are present on every system, and are always part of the SYSTEM STATE save set. [Table 117](#) lists these basic components and references to their backup and recovery procedures.

Table 117 SYSTEM STATE save set basic components

SYSTEM STATE basic component	Special backup and restore considerations
COM+ Database	To complete the backup and recovery operation of the COM+ database, ensure that a valid temporary directory is set with the TEMP environment variable.
Internet Information Server (IIS)	“Internet information server” on page 738 provides details.
Registry	“Windows registry” on page 739 provides details.
Performance Counters	None

Optional components of the SYSTEM STATE save set

In Windows XP Professional and Windows Server 2003, the SYSTEM STATE save set can include optional components, under these conditions:

- ◆ The optional components have been installed.
- ◆ The components’ corresponding services have been started.

These SYSTEM STATE optional components and their procedures for backup and recovery are listed in [Table 118](#).

Table 118 SYSTEM STATE save set optional components

SYSTEM STATE optional component	Special backup and restore considerations
Active Directory (AD)	“Active Directory” on page 736 provides details.
Certificate Server	None
Cluster Server	Chapter 19, “Cluster Support” provides details.
File Replication Service (FRS, also called SYSVOL)	None

Components of the SYSTEM FILES save set

In Windows XP Professional and Windows Server 2003, the SFP feature prevents overwriting of certain essential system files (most commonly, dynamic link libraries and executables) by application installations. These files are called *system-protected files*. By preventing the replacement of these critical system files, file version mismatches are avoided that might otherwise cause application errors or system crashes. The SFP component includes SFP catalog files, system protected files, and system boot files (ntldr, ntdetect.com, and boot.ini). The SYSTEM FILES save set also includes the IA-64 EFI FAT partition component.

The system state must always be backed up at level full (partial backups are not allowed). However, the SFP component typically consists of more than 200 MB of data in over 1,500 files. If the SFP component were part of the NetWorker SYSTEM STATE save set, backing up or recovering the system state would be extremely resource-intensive. Therefore, NetWorker software backs up the SFP component in its own save set called SYSTEM FILES.

System File Protection (SFP)

For a full backup operation, specifying the SYSTEM FILES save set or save set *All* results in a full backup of the system-protected files. However, on an incremental or level 1-9 backup of the SYSTEM FILES save set or save set *All*, if any system-protected files have changed since the specified time, all system-protected files are backed up. If no system-protected files have changed, none will be backed up and no corresponding save set entry is made in the server's media index.

To ensure a proper recovery of the Windows Server 2003 (with no VSS license, or VSS disabled) or Windows XP Professional state of the computer, it is safest to restore all three SYSTEM save sets in the same operation. In the NetWorker User program, if only the SYSTEM FILES or SYSTEM STATE save set is marked for recovery, a dialog box displays a warning that both of these save sets should be recovered together. No such warning is provided for recoveries performed at the command-prompt.

Not all SFP files necessarily exist on a computer at any given time. Additional SFP files are sometimes installed automatically when a new Windows system component is installed. When this occurs, the new files have a creation date that corresponds to the system component installation date. But the files have a modification date that corresponds to the creation date of the Windows distribution. (The modification date of a new SFP file is usually the same modification date of the already existing SFP files.)

When a backup of save set *All* or the SYSTEM FILES save set detects new SFP files, it checks for the more recent of the file creation and file modification dates. If the more recent date is after the *as of time*, NetWorker software backs up *all* of the system-protected files.

Components of the SYSTEM DB save set

The NetWorker SYSTEM DB save set is used to back up the Windows Server 2003 (32 and 64 bit) or Windows XP Professional system databases that are installed and started.

[Table 119 on page 712](#) lists the system databases that are present by default and references to their backup and recovery procedures.

Table 119 SYSTEM DB save set basic components

SYSTEM DB basic component	Special backup and restore considerations
Content Index Server (CIS)	“Backing up the Windows Content Index Server” on page 82 and “Restoring Windows Content Index Server on Windows” on page 348 provide details.
Disk Quota Database	“Granting full permissions for backup of Disk Quota database” on page 85 provides details.
Removable Storage Database	Removable Storage database backup and recovery is not supported.
Windows Management Instrumentation	None

Note: The CIS appears in the SYSTEM DB save set only if Indexing Service is started.

Windows databases not included in the SYSTEM DB save set

[Table 120](#) lists the additional Windows Server 2003 and Windows XP Professional databases that NetWorker software supports. Each of these databases may be installed optionally. These databases are backed up as part of the file system, and *not* as part of any SYSTEM save set.

Table 120 Windows databases not in SYSTEM DB save set

Database	Backup and restore procedures
Distributed File System (DFS)	Appendix C, “Backing Up and Restoring a Microsoft DFS” provides details
Encrypting File System (EFS)	“Encrypting file system” on page 736 provides details.
Event logs	“Event logs” on page 738 provides details.
Sparse files	“Sparse files” on page 739 provides details.

Components of the SHAREPOINT save set

During a Microsoft SharePoint Portal Server (SPS) backup, a single save set called SHAREPOINT is saved. The SHAREPOINT save set can be restored only in its entirety.

Note: Microsoft Windows Server 2003 does not support SPS 2001.

The SHAREPOINT save set contains:

- ◆ Web Storage System files, including database, log, and backup patch files.
- ◆ Microsoft Search resources, including the property and subscription stores, full-text index files, and propagated indexes.
- ◆ Server configuration information for the Web Storage System, content sources, server properties, and access accounts.
- ◆ The Applications folder, which contains a subfolder for each workspace on the server. Each subfolder can include searchable applications designed for the Web Storage System.
 - All application-specific data stored in the Web Storage System is included.
 - All application-specific data stored outside the Web Storage System (such as registry settings) is not included.
- ◆ Any shortcuts or content sources that reference the local file system. Note that these do not work if the referenced content does not exist on the computer where the SHAREPOINT save set is restored. Also, you must restore any shortcuts to workspaces in My Network Places.

The SHAREPOINT save set does not contain:

- ◆ Scheduled tasks for processing subscriptions. SPS processes subscriptions based on default schedules at the time of the recovery operation.
- ◆ The gather log that SPS creates each time it updates an index. This file contains data about the URLs that SPS accesses while generating an index.

Components of the ASR save set

The ASR (Automated System Recovery) save set contains all the information necessary to return the failed computer to its condition at the time of the last ASR backup, including:

- ◆ Automated reinstallation of Windows
- ◆ Restoration of the system configuration
- ◆ Recovery of one or more disk volumes

The ASR save set can be backed up by itself, or as a component of save set *All*. Like other SYSTEM save sets, ASR is automatically backed up at level full.

[Chapter 23, “Support for Windows XP and 2003 Automated System Recovery”](#) provides more information about NetWorker software support for ASR.

VSS SYSTEM save sets

The VSS SYSTEM save sets discussed in this section work with Windows Server 2003, where VSS is licensed and enabled, and Windows Server 2008.

The VSS SYSTEM SAVE SET includes the VSS System Boot, VSS System Fileset, and VSS System Services, along with three non-system components, VSS User Data, VSS Other and VSS ASR Disk (Windows Server 2003 only).

Components of the VSS SYSTEM BOOT save set

The VSS SYSTEM BOOT save set includes all elements of the Windows system state, except the VSS System Writer writer and the SFP component. It also includes the ASR System Files legacy component. All other components are dynamically generated, and therefore may differ each time NetWorker software runs.

The following new VSS writers were introduced in Windows Server 2008 R2 and Windows 7:

- ◆ Performance Counters Writer
- ◆ Task Scheduler Writer
- ◆ VSS Metadata Store Writer

NetWorker client on Windows Server 2008 R2 and Windows 7, supports the backup of these new VSS writers. These writers are backed up as a part of VSS SYSTEM BOOT FILES save set.

[“Components of the VSS SYSTEM FILESET save set” on page 714](#) provides information about how NetWorker software treats the SFP component.

Components of the VSS SYSTEM FILESET save set

The VSS SYSTEM FILESET save set includes the VSS System Writer writer, the SFP component, and the IA-64 EFI FAT partition legacy component. This save set component is recovered by using the legacy method of recovery.

Most of the elements of the Windows system state are part of the VSS SYSTEM BOOT save set. However, the SFP component typically consists of more than 200 MB of data in more than 1,500 files. If the SFP component were part of the NetWorker VSS SYSTEM BOOT save set, backing up or recovering the system state would be extremely resource-intensive. To relieve the strain on resources, NetWorker software backs up the SFP component as part of the VSS SYSTEM FILESET save set.

[“Components of the SYSTEM FILES save set” on page 711](#) provides more information about the SFP component.

System File Protection (SFP)

For a full backup operation, specification of the VSS SYSTEM FILESET save set or save set *All* results in a full backup of the system-protected files. However, on an incremental or level 1-9 backup of the VSS SYSTEM FILESET save set or save set *All*, if any system-protected files have changed since the specified time, all system-protected files are backed up. If no system-protected files have changed, none will be backed up and no corresponding save set entry is made in the server's media index.

To properly recover the entire system, especially in a disaster recovery situation, back up and recover VSS SYSTEM BOOT, VSS SYSTEM FILESET, VSS SYSTEM SERVICES,

and all boot/system volumes. During recovery, if you choose not to mark all three save sets, a warning message will appear with the option to mark the other save sets. The *NetWorker Disaster Recovery Guide* provides more information.

Note: When performing a disaster recovery in multiple Windows platforms and copying the registry, a failure may be reported during the recovery of **VSS SYSTEM BOOT**: due to the size of the **PendingRenameFileOperations** registry value, which is populated during the disaster recovery. The error message indicates a lack of system resources. If this error appears, it is recommended to set the variable `NSR_RECOV_TEMP_CLEANUP` to an appropriate value (for example, 1) in the system space, and then restart the disaster recovery. Setting this variable ensures that the error does not appear, and that the recovery and subsequent cleanup of the temporary recover files after restart occur without this interruption.

Not all SFP files necessarily exist on a computer at any given time. Additional SFP files are sometimes installed automatically when a new Windows system component is installed. When this occurs, the new files have a creation date corresponding to the system component installation date. They also have a modification date that corresponds to the creation date of the Windows distribution. (The modification date of a new SFP file is usually the same modification date of the already existing SFP files.)

When a NetWorker backup of save set *All* or the VSS SYSTEM FILESET save set detects new SFP files, NetWorker software checks for the more recent of the file creation and file modification dates. If the more recent date is after the *as of time* value, NetWorker software backs up *all* of the system-protected files.

Components of the VSS SYSTEM SERVICES save set

The VSS SYSTEM SERVICES save set includes all elements of the Windows System Services. It also includes the Disk Quota database legacy component, File Server Resource Manager (FSRM) Disk Quota, and the DFS Replication writer. In addition, for Windows Server clusters, it includes the Cluster writer.

The Disk Quota database legacy component of the save set is recovered by using the legacy method of recovery. All other components of this save set are dynamically generated and may differ each time NetWorker software runs.

The FSRM Disk Quota component can only be backed up with a VSS enabled backup, which requires a VSS license.

Windows Server Cluster writers

Backup and recovery of Windows Server cluster is supported for Windows Server 2003 and Windows Server 2008. There are some differences in the Cluster Writer save set names between Windows Server 2003 and Windows Server 2008.

In Windows Server 2003, the NetWorker software uses the following specifications:

- ◆ Cluster writer name: Cluster Service Writer
- ◆ Backup and recovery save set: Under the VSS SYSTEM SERVICES system save set
- ◆ Mode: Regular recovery mode only, using the NetWorker user interface or command line.

In Windows Server 2008, the NetWorker software uses the following specifications:

- ◆ Cluster writer name: Cluster Database
- ◆ Backup and recovery save set: Under the VSS SYSTEM SERVICES system save set

Components of the VSS USER DATA save set

The VSS USER DATA save set includes application data that is not system-critical. Components of this save set are dynamically generated and may differ each time NetWorker software runs.

Components of the VSS OTHER save set

The VSS OTHER save set includes application data that is not system-critical. Components of this save set are dynamically generated and may differ each time NetWorker software runs.

Components of the VSS ASR DISK save set

The VSS ASR DISK save set includes the ASR legacy component. This is a legacy save set and is recovered by using the legacy method of recovery.

Note: The VSS ASR DISK save set is not supported by NetWorker for Windows Vista nor Windows Server 2008.

This appendix covers these topics:

◆ Overview	718
◆ Configuring the port ranges in NetWorker software.....	718
◆ Ports needed in the service ports range for NetWorker 7.3.x and later	720
◆ Ports needed in the service ports range for NetWorker 7.2.x	723
◆ Ports used by NetWorker add-on products	724
◆ Example of a firewall configuration	725
◆ Access control to local host resources	726
◆ Firewall port enhancement	727

Overview

Many differences exist in the number of ports used by NetWorker release 7.3 and later, from the earlier releases. Also if you operate in a mixed environment, calculating the ports required by the NetWorker software is more complicated with the later releases. Consequently, this appendix is divided into sections that specifically describe each NetWorker release. Separate sections describe mixed environments and NetWorker add-ons.

This appendix also provides an example of firewall configuration, access control to local host resources, and firewall port enhancement.

Configuring the port ranges in NetWorker software

NetWorker software and some add-on products use ports from a range that is stored in the nsrla database. The port ranges are stored in the "NSR system port ranges" resource and there are several ways to view or update their values. There are two sets of port ranges:

- ◆ Connection port range
- ◆ Service port range

Connection ports range

TCP client side ports are only selected from this range, which should be kept as wide as possible. There are no security concerns in keeping this range as wide as possible although NetWorker performance problems or random malfunctions may occur if the range is too narrow. In release 7.2 the default value for this range is: 10001-30000. In NetWorker 7.3, the default value, which is 0-0, indicates that the NetWorker software will allow the operating system to select the port for TCP clients. You can only do this when using NetWorker 7.3 and later.

Service ports range

The NetWorker TCP/UDP server processes use ports in this range. The default value for the service ports range is 7937–9936. This range can be narrowed or expanded, as discussed in this chapter.

The ports used by the NetWorker Management Console (NMC) server are configured separately from the NetWorker service ports range. The default ports NMC uses are ports **9000** and **9001**. NetWorker services should therefore, at a minimum, not include these ports in the default range. EMC recommends not including ports 9000–9010 in the service ports range.

When configuring a firewall, you must open the port range described by the "Service ports" range in the firewall, for TCP connections. The NetWorker software does use some ports from this range for UDP services, but these are not essential. UDP service ports must be opened in the firewall for TCP connections, although there is no need to allow UDP connections through the firewall. The ports required by various daemons are selected at random from the service ports range.



IMPORTANT

The `nsrexecd` command, when used on every type of NetWorker host, will always try to listen on ports 7937 and 7938. Both of these ports should therefore be kept available. Also, `rpcbind` (portmapper) should be running and available through the firewall in case port 7938 is not available. Otherwise, the NetWorker software will not function correctly.

Anytime you change the service or connection port range used by a NetWorker host, you must restart all NetWorker processes on that computer for those changes to take effect. You must do this no matter which method you use.

In order to change the port ranges on a system, you must have update access to the "NSR system port ranges" resource in `nsrexecd`, that is, you must be in the "administrator" list for that resource. ["Access control to local host resources" on page 726](#) provides more information about access control on this resource.

Using the `nsrports` command to update port ranges

The `nsrports` program is used to view and update the port ranges. To view port ranges, enter:

```
$nsrports -s shadow.emc.com
```

In this example, the port ranges for NetWorker host `shadow.emc.com` are displayed:

```
Service ports: 7937-9936
Connection ports: 0-0
```

To update the service ports range, enter:

```
$nsrports -s shadow.emc.com -S 7937-8937
```

As seen in this example, the service port range on `shadow.emc.com` was changed from 7937-9936 to 7937-8937. You can enter multiple ranges for those cases where you can not have a a solid range. This is illustrated in this example

```
nsrports -s shadow.emc.com -S 7937-7938 10000-11000 11500
```

In this case the service ports range for host: `shadow.emc.com` is set to use ports 7937-7938, 10000-11000, and 11500.

Using the Console to update the port ranges

You can only use the Console to update the port ranges if you are using the Console server that ships with the current NetWorker release.

To use the Console to update the port ranges on a host:

1. Go to the **Configuration** screen.
2. Select the **Local Hosts** entry for the computer on which you want to update the port ranges. You select the entry from the left side of the screen in tree view.
3. Right-click the **Local Hosts** entry.
4. Select **Configure Port Ranges....**
5. Change the value of the desired range. For multiple ranges, type one range per line.
6. Click **OK** when complete.

Using nsradmin to update the port ranges

To view the current port ranges on a system, type:

```
$nsradmin -p nsrexec -s shadow.emc.com

NetWorker administration program.
Use the "help" command for help, "visual" for full-screen mode.
nsradmin> p type: nsr system port ranges
  type: NSR system port ranges;
  service ports: 7937-9936;
  connection ports: 0-0;
  administrator: *@localhost;
nsradmin>
```

To update the service ports range, type:

```
$nsradmin -p nsrexec -s shadow.emc.com

NetWorker administration program.
Use the "help" command for help, "visual" for full-screen mode.
nsradmin> . type: nsr system port ranges
Current query set
nsradmin> update service ports: 7937-7938, 9011-9100
  service ports: 7937-7938, 9011-9100;

Update? y
updated resource id
0.13.3.219.0.0.0.0.0.0.0.0.0.0.67.30.89.147.137.69.168.98(6)
nsradmin>
```

Multiple port ranges were created in the previous example. Notice that each range is separated by commas.

Ports needed in the service ports range for NetWorker 7.3.x and later

The Console is shipped and installed as part of NetWorker 7.3.x. Because of this, a new required component called the Console server is available. The NetWorker Console server must be installed to manage and monitor NetWorker servers. It is best to install it on just one computer in the network to take full advantage of the Console's consolidated reporting feature. As in previous versions of Console, the ports used by the Console server are configured separately, in separate configuration files, from the ports that the NetWorker software uses. As a result, the ports that the Console server uses are not calculated by **nsrports**, in the normal range of ports. This also means that these ports can be addressed separately from the ports calculated for the rest of the NetWorker software. [“NetWorker Management Console” on page 722](#) provides additional information on configuring these ports.

These daemons were introduced in NetWorker 7.3 and are shipped with NetWorker release 7.3.x:

- ◆ **nsrmmgd**
- ◆ **nsrlcpd**
- ◆ **nsrjobd**

Each of these daemons use one port and two new ports are used by **nsrexecd**. This demonstrates why the configuration of NetWorker 7.3 is different from that performed for NetWorker 7.2.x.

The NetWorker server

These daemons only run on the server:

- ◆ **nsrd**
- ◆ **nsrmmdbd**
- ◆ **nsrindexd**
- ◆ **nsrmmgd**
- ◆ **nsrjobd**

Each of these daemons uses one port for TCP servers. The **nsrexecd** daemon also runs on the server and it uses 4 ports. Both the **nsrlcpd** and **nsrmmmd** daemons run on either a storage node or on the server (because the server is acting as a storage node). These daemons take one port per instance. There is one **nsrlcpd** daemon for each jukebox managed by the NetWorker software, and this is started on the computer that manages that jukebox. This computer can be either the NetWorker server or storage node.

There is one **nsrmmmd** daemon for each NetWorker configured device, unless that is an **adv_file** type device. The **adv_file** type device requires two **nsrmmmds** be started. The **nsrmmmd** daemon starts on the computer that manages the device. When spanning from one medium to another, an extra **nsrmmmd** is started to mount the new tape. This **nsrmmmd** is known as a 'helper mmd' and each instance requires one port.

Helper **mmds** take dynamic ports, so that even though the ports are not in use when you start the NetWorker software, they will be in use when you span media. Since multiple devices can span simultaneously, it is best to assume that each device requires two ports.

The processes **nsrd** and **nsrmmgd**, each require one port for UDP services. These ports do not really need to be accessed from outside the firewall, but they are taken from the service ports range configured using **nsrports**. Therefore, they need to be added to the formula to calculate the number of ports needed in the service ports range.

The formula for how many ports the NetWorker server requires is therefore:

- ◆ NetWorker 7.3.x
 $11 + 2 * \#devices + \#jukeboxes$
- ◆ NetWorker 7.4.x and later
 $12 + 2 * \#devices + \#jukeboxes$
the additional port is required for the software distribution feature (**nsrpush**).

where:

- ◆ *#devices* is the number of devices configured on the NetWorker server only.
- ◆ *#jukeboxes* is the number of jukeboxes configured on the NetWorker server only.

NetWorker storage node

The only storage node daemons that are run are:

- ◆ **nsrexecd**
- ◆ **nsrmmmd**
- ◆ **nsrlcpd**

As described previously, **nsrexecd** uses four ports, **nsrmmmd** uses two ports per device, and **nsrlcpd** uses one port per jukebox. From this, the number of ports required by a NetWorker storage node is:

$$4 + 2 * \#devices + \#jukeboxes$$

where:

- ◆ *#devices* is the number of devices configured on the NetWorker storage node only.
- ◆ *#jukeboxes* is the number of jukeboxes configured on the NetWorker storage node only.

NetWorker client

The only daemon running on the NetWorker 7.3 client is **nsrexecd** and it uses four ports. Therefore the port usage formula for a NetWorker client is 4.

NetWorker Management Console

The NetWorker Management Console (NMC) is used to administer the NetWorker server and can also administer some of the NetWorker Client resources.

The NMC server requires the following ports:

- ◆ A HTTP port that is used for the NMC embedded web server. It is used to download the NMC user interface, which is a Java application. This port is selected during the installation process. The default port value is 9000.
- ◆ An RPC port for calls from the NMC Java client to the NMC server. This port is selected during the installation process. The default port used is 9001.
- ◆ The database queries port. The default port value is 2638.
- ◆ An SNMP port for getting information from the Data Domain system. The default port value is 161.
- ◆ An SNMPTRAPD port for capturing Data Domain SNMP traps. The default port value is 162.

The ports used by NMC are *not* configured by using **nsrports**.

How to enable Console client/server connections through a firewall

To enable clients to connect to the Console server through a firewall, configure the firewall for communication over the HTTP, Client Service, and TDS (Tabular Data Stream protocol) port numbers:

1. Determine the two port numbers used for connecting to the Console server:

Note: To identify the specified ports, refer to the GST server package in the install.log file. Look for the following expressions as part of larger expressions:

- `http_svc_port -t int -v http_service_port`
- `clnt_svc_port -t int -v client_service_port`

where *http_service_port* and *client_service_port* are port numbers. By default, the HTTP service port is set to 9000 and the client service port is set to 9001.

2. Use the firewall software to accept inbound and outbound (TCP packets from the HTTP and client service ports determined in step 1.

3. Use the firewall software to accept inbound and outbound TDS packets from the database queries port, which is 2638 by default.
4. Use the firewall software to accept inbound and outbound requests for the SNMP port, which is 161 by default.
5. Use the firewall software to accept inbound requests for the SNMPTRAPD port, which is 162 by default.
6. Repeat [step 2](#) and [step 3](#) for any other firewalls used with this connection.

Ports needed in the service ports range for NetWorker 7.2.x.

In NetWorker release 7.2.x, the dynamic ports used by nsrexec become redundant.

NetWorker server

These daemons only run on the server:

- ◆ **nsrd**
- ◆ **nsrindexd**
- ◆ **nsrmmdbd**

Each of these daemons uses one port although, **nsrexecd** also runs on the NetWorker server and it uses two ports. The **nsrmmmd** process can run on either the server or storage node. It runs on the computer responsible for managing the device. One **nsrmmmd** process is started per device (except for `adv_file` type device which has two **mmds** started). During spanning, one additional **nsrmmmd** helper, which uses a dynamic port, is started. Since spanning can simultaneously take place on all devices, **mmd** daemons essentially use two ports per device configured on the host in question.

Unfortunately, the **nsrd** process uses one port for a UDP service. This port does not really need to be accessed from outside the firewall, but the port is taken from the service ports range configured by using **nsrports**. Therefore, this port needs to be added to the formula to calculate the number of ports needed in the service ports range.

The formula for how many ports the NetWorker server requires is therefore:

$$6 + 2 * \#devices$$

The `#devices` only includes those devices that are configured on the NetWorker server.

NetWorker storage node

Both **nsrexecd** and **nsrmmmd** are the only daemons that run on the storage node. The **nsrexecd** (like on the server) daemon uses two ports, while the **nsrmmmd** daemon uses two ports for each device configured on the host.

The NetWorker 7.2.x port usage formula is:

$$2 + 2 * \#devices$$

Note: The `#devices` only includes the devices configured on the NetWorker storage node in question.

NetWorker client

The **nsrexecd** daemon, which uses two ports, is the only one running on the NetWorker client. Therefore, the formula for port usage on the NetWorker client is 2.

Ports used by NetWorker add-on products

This section details the ports used for various NetWorker add-on products. Some add-on products use ports from the range configured using **nsrports**, others have their own configuration files.

If a NetWorker add-on product uses ports from outside the range configured by using **nsrports**, they do not need to be included in the formula used to calculate the range entered using **nsrports**. However, it is still important that the ports used by that add-on, *not* overlap the range used by the NetWorker software on the host where the add-on is installed. If the add-on product ports do overlap the NetWorker port range, neither product will be able to use the ports they require.

AlphaStor

If there is a firewall between AlphaStor and NetWorker software, the following ports should be opened:

- ◆ With NetWorker release 7.2:
 - Port 44444 should be opened between the AlphaStor software and the NetWorker server.
This port uses long-running connections. The firewall should not be configured to close the port due to inactivity to prevent media from being unmounted during backup.
 - Port 41025 should be opened between the AlphaStor software and the NetWorker server and/or NetWorker client for command line operations.
- ◆ With NetWorker release 7.3 and newer:
 - Port 44475 should be opened between the AlphaStor software and the NetWorker server.

Additionally, if there is a firewall between the AlphaStor software and the host running the AlphaStor Graphical User Interface, port 44470 should be opened in the firewall.

Ports required for communication between AlphaStor software and storage libraries

If there is a firewall between the AlphaStor software and a host with an AlphaStor-controlled library connected to it, the following ports should be opened:

- ◆ Port 3500 should be opened between the AlphaStor software and the host controlling the library's robotics.
- ◆ Port 3000 should be opened between the AlphaStor software and the host access the drives.

Client Backup Configuration Wizard

The Client Backup Configuration wizard speeds the process by which a NetWorker client is configured, on the NetWorker server, for being backed up. Prior to NetWorker release 7.3, the client backup configuration wizard was shipped as a

separate add-on product. With NetWorker release 7.3 it became, like the Console, a part of the main NetWorker product.

The NetWorker Client Backup Configuration wizard uses one port for each open user interface on the NetWorker client. This is a dynamic port and that is closed when the wizard is closed.

These ports are selected from the port range configured by using **nsrports**.

NDMP

The NDMP extension uses 1 transient port (port number 10,000) whenever an NDMP filer is being backed up. When backing up an NDMP Server to a NetWorker storage node that uses DSA, DSA is dynamically spawned for each backup and recover. As it is spawned, DSA listens on a port that falls within the NetWorker service port range and closes the connection once the backup or recover is finished. DSA listens on an unused transient port from within the NetWorker service port.

NetWorker modules

SnapImage uses 1 transient port (port number 10,000), specified in `/etc/services` much like other standard services, although this can be changed manually during installation.

The data connection used between the NetWorker storage node and the SnapImage data server (if they are remote), is within the NetWorker service port range. Another NDMP service (NDMP tape server) uses the system reserved port (0-1024 range) to accept the connection. The connecting client (NDMP data server) uses the ephemeral ports generated by the system.

Example of a firewall configuration

The following is an example of a firewall configuration.

ABC Company has a NetWorker server behind a bi-directional firewall that controls both incoming and outgoing traffic. The NetWorker server has a locally-attached media library with six devices. This will require 25 service ports: $12 + 2 * [\text{number of devices}] + [\text{number of libraries}]$. Therefore, the server must be configured to use 25 service ports and the firewall must allow incoming traffic from outside the firewall to the server on these 25 ports.

The company also has three storage nodes outside the firewall. Each storage node has one library with six devices. Each storage node will require 17 service ports: $4 + 2 * [\text{number of devices}] + [\text{number of libraries}]$. The firewall will need to be configured to allow outgoing traffic from the server through the firewall to the storage nodes. However, each storage node can use the same service ports. Therefore, the firewall only needs to allow outgoing traffic to the storage nodes' IP addresses through a total of 17 ports. Furthermore, these can be the same ports that the server uses for its service ports.

The company also has several clients outside the firewall. Each of these clients requires four service ports. The firewall will have to allow outgoing traffic from the server to the clients on the clients' service ports. However, all client can use the same four service ports. Furthermore, the ports can be the same ports that the storage nodes use for their service ports.

Therefore, the simplest configuration for ABC Company to allow all necessary communication through their firewall would result in a total of 25 ports opened for incoming communication to the server, with 17 of those ports also opened for outgoing communication from the server to the clients and storage nodes.

Multiple firewalls

The ABC Company can include multiple firewalls, with one or more storage nodes and some clients behind each firewall. In this case, each firewall should be configured the same.

Additional ports that may be required

If ABC Company also wishes to have the NetWorker Console server installed inside the firewall, and allow users to launch the Console GUI from outside the firewall, four additional service ports should be opened through the firewall. The client backup configuration wizard will use a client-side service port, so they may decide to configure an additional service port on each client (for a total of five). NetWorker modules may also require additional ports.

Access control to local host resources

Most resources inherit their administrator list from the NSR resource. The NSR administrator list is only a copy of the list of users in the Administrators entry from the NSR usergroup resource. However, there are a few resources for which this is not true. These exceptions are the resources that you configure using the Local hosts list in the Console Configuration Window.

When selecting a host from the Local hosts list in the Console Configuration Window, you are administering resources on the host that you selected. You are not administering resources on the NetWorker server. It is important to remember this because all other resources in the Console configuration window reside on the NetWorker server. The host on which you configure a resource is the one that you select in the Local hosts tree entry. This selection is made from the left window pane in the Console configuration window.

The Administrator attribute for resources selected from a Local hosts entry is different from the Administrator attribute in the NSR resource. The NSR resource appears when you right click the root of the tree in the Console configuration window and then select Properties.

The user identified as *administrator@gstd_machine* is not automatically included in the Administrator attribute for these resources. In this case, *gstd_machine* is the hostname of the device where the Console server is installed.

Firewall port enhancement

NetWorker 7.5 uses the sun portmapper on port 111 and its own portmapper (default port 7937 and 7938) for RPC lookups. If you have a firewall that blocks these ports, you may see delays up to four minutes per connection. You can reconfigure NetWorker to use its own portmapper on a different static port number you have opened through your firewall. Setting the portmapper causes it to avoid using the system portmapper.

To enable NetWorker portmapper:

1. Add the following lines to your services file:

```
nsrrpc <portnumber>/udp  
nsrrpc <portnumber>/tcp
```

2. Restart the NetWorker services.

Configure the server, its storage nodes, and its clients in the same way.

This appendix covers these topics:

- ◆ Overview of a Microsoft Distributed File System (DFS) 730
- ◆ DFS-R granular recovery on Windows 2008 and 2008 R2..... 730
- ◆ DFS backups and restores for Windows 2003 731

Overview of a Microsoft Distributed File System (DFS)

Microsoft distributed file system (DFS) is a Windows file system feature that allows you to create a namespace of shared directories that are physically distributed across a network. With DFS you can organize a set of distributed directories logically, according to any scheme you choose, to provide centralized access to files that reside in a variety of locations.

Benefits of DFS include:

- ◆ Easy browsing of servers.
- ◆ Simplified searches for files and data.
- ◆ Server load balancing.

Domain-based DFS versus registry-based DFS

Windows supports two types of DFS:

- ◆ Domain-based DFS, where DFS topology information is stored in Active Directory (AD) on the domain controllers. Because this information is replicated on multiple domain controllers, domain-based DFS is fault tolerant. The DFS host server can be any Windows domain controller or member server.
- ◆ For registry-based DFS (also called *stand-alone DFS*), the DFS topology information is stored in the Windows registry on the DFS host server.

DFS junctions

A DFS junction is a DFS root (namespace for files and DFS links) or a DFS link (connection to a shared file or folder). DFS junctions are file system objects, but are not files or directories. Therefore, the NetWorker software does not treat DFS junctions the same as files or directories for backup and recovery. However, DFS junctions appear as files and directories in the NetWorker User program.

Note: The DFS terminology Microsoft uses with Windows 2003 and later operating systems is different than that used with Windows NT 4.0. For example, in Windows NT 4.0 DFS junctions are called DFS components.

DFS-R granular recovery on Windows 2008 and 2008 R2

NetWorker Release 7.5 Service Pack 2 and higher support Windows Distributed File System Replication (DFS-R) granular recovery. With this support, DFS-R Shared Directories can be backed up like standard file directories. This allows granular DFS-R folder and file recoveries on Windows Server 2008 and Windows Server 2008 R2 operating systems. Users will not have to recover the entire VSS SYSTEM save sets to restore DFS-R shared directories.

Be aware that DFS-R namespaces are not backed up in VSS SYSTEM save sets. Also, namespaces are skipped when specifying the saveset All. Users must back up namespaces directly by specifying the path of the namespaces as separate savesets in the NetWorker client's **Save Set** attribute.

For recovery of namespace data, use the NetWorker User program and select individual files or folders.

DFS backups and restores for Windows 2003

If the NetWorker Module for Microsoft Applications is installed on the client computer, refer to the *EMC NetWorker Module for Microsoft Applications Administration Guide* for DFS information.

A complete NetWorker backup of a DFS requires backups of the following:

- ◆ DFS topology information
- ◆ DFS junctions
- ◆ DFS destination directories (shared directories connected to DFS links)

Note: The NetWorker software does not traverse DFS links and therefore does *not* back up DFS destination directories as a part of the DFS junctions backup. To properly protect data, back up the DFS destination directories.

DFS topology information

Domain-based DFS topology information is backed up as part of AD, which is a component of the SYSTEM STATE or VSS SYSTEM BOOT save set on domain controllers. Registry-based DFS topology information is backed up as part of the Windows registry, which is a component of the DFS host server's SYSTEM STATE or VSS SYSTEM BOOT save set. [Appendix A, "SYSTEM and VSS SYSTEM Save Sets"](#) provides more information about the SYSTEM or VSS SYSTEM save sets.

DFS backup consideration with VSS

If VSS is enabled, a DFS backup or a VSS SYSTEM BOOT backup may fail under the following conditions:

- ◆ The namespace folder is not a shared folder target.
- ◆ Replication is configured for the namespace.
- ◆ Files exist in the namespace folder and have replicated to the member server.

To avoid this issue, create a namespace in the folder target or do not enable replication.

Configuring a scheduled DFS backup

To avoid inconsistencies among the various save sets, configure a scheduled backup that includes the DFS topology information, junctions, and destination directories.

To configure a scheduled backup for a DFS:

1. From the **Administration** window, include the following clients in the NetWorker group that will be back up the DFS:
 - The DFS host server
 - Any computer where remote DFS destination directories reside
 - A domain controller (domain-based DFS only)

For example, you could create a NetWorker group named DFS, then make each of the preceding clients a member of the DFS group. [Chapter 2, "Backing Up Data"](#) provides more information about configuring a scheduled backup.

2. Enter these save sets in the **Save Set** attribute for the DFS host server's **Client** resource:

- The DFS root. For example:

C:\MyDfsRoot

- DFS destination directories that reside on the DFS host. For example:

D:\MyLocalDir

Note: DFS destination directories are also be backed up if you enter the entire volume (for example, D:\) in the Save Set attribute.

- For registry-based DFS only, include the following SYSTEM save sets in the DFS host server's **Save Set** attribute:

SYSTEM STATE:

SYSTEM FILES:

If VSS is licensed and enabled, include these VSS SYSTEM save sets:

VSS SYSTEM BOOT:

VSS SYSTEM FILESET:

3. For clients where remote DFS destination directories reside, enter the destination directory paths in the **Save Set** attribute. For example:

E:\MyRemoteDir

E:\MyOtherRemoteDir

E:

4. For domain-based DFS only, include the following SYSTEM save sets in the domain controller's **Save Set** attribute:

SYSTEM STATE:

SYSTEM FILES:

If VSS is licensed and enabled, include the following VSS SYSTEM save sets:

VSS SYSTEM BOOT:

VSS SYSTEM FILESET:

Restoring a DFS

Note: The SYSTEM STATE save set, or the VSS SYSTEM BOOT save set and the AD can be restored as a single unit only. [Appendix A, "SYSTEM and VSS SYSTEM Save Sets"](#) provides more information.

To restore a DFS:

1. Restore the DFS topology information:
 - To restore a domain-based system, restore the SYSTEM STATE and SYSTEM FILES (or VSS SYSTEM BOOT and VSS SYSTEM FILESET) save sets on the domain controller.
 - To restore a registry-based system, restore the SYSTEM STATE and SYSTEM FILES (or VSS SYSTEM BOOT and VSS SYSTEM FILESET) save sets on the DFS host server.

Chapter 13, "Recovering Data" provides recovery procedures.

2. On the DFS host server:

- Restore the DFS root.

Note: You cannot restore individual DFS links. If the DFS root has lost a link, restore the entire DFS root in which that link resided.

- If necessary, restore any local DFS destination directories.

3. If necessary, restore the remote DFS destination directories.

Authoritative restores of DFS Replication writers

Authoritative restores of the DFS Replication writers must be performed from the command line. Restores from the NetWorker User program Graphical User Interface (GUI) will be nonauthoritative.

To perform an authoritative restore of the DFS Replication writer on Windows 2003 systems, use the **-U** option of the **recover** command.

To restore the DFS Replication writer on Windows 2003 systems, type the following command:

```
recover -s server -U -N "VSS USER DATA:\DFS Replication service  
writer"
```

Note: You cannot select individual components within the writer for recovery.

This appendix covers these topics:

◆ NetWorker Module for Microsoft Applications	736
◆ Active Directory	736
◆ Encrypting file system	736
◆ Event logs	738
◆ Internet information server.....	738
◆ Windows registry	739
◆ Sparse files.....	739
◆ Windows Change Journal	739
◆ Advanced Configuration and Power Interface.....	742
◆ Windows print queues	743

NetWorker Module for Microsoft Applications

NetWorker Module for Microsoft Applications (NMM) was previously known as NetWorker VSS Client for Microsoft Windows Server 2003. NMM provides VSS-based backup and recovery of Windows, as well as Microsoft server applications such as Microsoft Exchange Server, Microsoft SQL Server, Microsoft Data Protection Manager (DPM), and Microsoft Office SharePoint Services.

If NMM is installed on the client computer, refer to the *NetWorker Module for Microsoft Applications Administration Guide* for documentation about that product.

There are also separate modules available for Microsoft Exchange Server and Microsoft SQL Server:

- ◆ **EMC NetWorker Module for Microsoft Exchange** to back up and recover Microsoft Exchange Server.
- ◆ **EMC NetWorker Module for Microsoft SQL Server** to back up and recover Microsoft SQL Server.

Active Directory

Active Directory (AD) is the Windows directory service and the foundation for the Windows Distributed File System. AD is a component of the Windows system state on Windows Server 2008 and 2003 domain controllers. A domain controller is a computer that stores directory data and manages user interactions with a domain, including login, authentication, directory searches, and access to other shared resources.

Backing up Active Directory

The NetWorker software automatically backs up AD as a component of the SYSTEM STATE or VSS SYSTEM BOOT save set. An AD backup or restore includes the AD log files, database, patch files, and expiry token.

Recovering Active Directory

The *EMC NetWorker Disaster Recovery Guide* contains information about the online recovery of Active Directory. [Chapter 24, "Support for Windows 2008 / 2008 R2 / Windows 7 Disaster Recovery,"](#) provides information about the bare metal recovery of an Active Directory host.

Encrypting file system

Windows Encrypting File System (EFS) allows NTFS files to be stored in encrypted format. A user without the private key to the file cannot access the file.

Consider these when backing up or recovering files or folders that are encrypted with EFS:

- ◆ NetWorker software will not encrypt or compress a file already encrypted by Windows.
- ◆ Do not use AES encryption when backing up files that are encrypted using EFS.

- ◆ Files can become unusable if the encryption keys change on the domain controller. Reasons include:
 - The domain controller functionality is moved from one computer to another
 - The domain controller crashes.
- ◆ NetWorker software does not back up encryption keys. If the EFS is reinstalled after a disaster, the new security keys will not match the recovered keys and the recovery will fail. Keep a copy of the keys to ensure a successful recovery.
- ◆ You cannot perform a directed recovery of encrypted files.
- ◆ When recovering encrypted files to an encrypted folder that has been removed, consider the following:
 - If you recover the encrypted files *and* the encrypted folder, the recovered folder and files are all encrypted.
 - If you recover only individual encrypted files (but do not recover the encrypted folder that contains them) the individual recovered files are encrypted but the re-created folder is *not* encrypted. Microsoft Windows documentation provides instructions on encrypting the re-created folder.

Event logs

Event logs can be used for troubleshooting hardware problems as well as monitoring security conditions, and system and application software problems.

If no VSS client license exists, or if VSS is disabled, the NetWorker software backs up event logs for services that are running at the time of the backup. You can restore event logs to the same location or to a new location on the computer and then view them with the Microsoft Event Viewer.

The size of a restored event log might be smaller than the size of the corresponding backed-up log. This is characteristic of Windows event logs and does not cause any loss or modification of data. The recovered, smaller log can still be viewed in the Microsoft Event Viewer.

If more than one active event log is marked for backup (for example, SecEvent.Evt and SysEvent.Evt), all event logs are backed up.

Event logs can be recovered to a location different than the location from which they were backed up. However, event logs cannot be recovered to a FAT16 or FAT32 partition if they were backed up from an NTFS partition.

If VSS is licensed and enabled, event logs are backed as a component of the VSS SYSTEM SERVICES save set.

Note: Windows Server 2008 and Windows Vista do not have an event log writer. The event logs will not be backed up as part of the VSS system save sets. The event logs are backed up as part of the file system. To back up the event logs, you should perform a regular (non-VSS) backup of the `system32\winevt\logs` folder.

Internet information server

Internet Information Server (IIS) is a web server that enables the publication of information on the Internet or a corporate intranet by using HTTP.

The NetWorker software backs up IIS using its active metabase and restores backup versions to the metabase location, which can be at the default location (`%SystemRoot%\system32\inetsrv\MetaBase.bin`) or in a location specified in the registry. The Microsoft documentation provides information about creating a registry key to specify an alternate metabase location.

Relocation of the IIS metabase is not supported in IIS version 6.0.

Note: If you perform a NetWorker recovery of the SYSTEM STATE or VSS SYSTEM BOOT save set (which includes the active metabase), and reboot, the Network News Transfer Protocol (NNTP) virtual server might not start. In that case, rebuild the NNTP index and hash table files. The Microsoft NNTP documentation provides more information.

Windows registry

For supported Windows Server versions, the registry is a component of the system state. The registry can be backed up and restored only as part of the SYSTEM or VSS SYSTEM save set to which it belongs.

In the NetWorker User program, the registry is a component of the SYSTEM STATE or VSS SYSTEM BOOT save set. The NetWorker software automatically backs up or recovers the registry as well as this save set.

The registry is always saved and restored at level full.

Backward compatibility with earlier NetWorker releases

The Windows NT registry save set is no longer supported in the NetWorker software. In supported Windows versions, the registry is part of the system state. The NetWorker software includes the registry as a component of the SYSTEM STATE or VSS SYSTEM BOOT save set. Specifying registry as a save set in a Client resource does *not* result in a backup of the Windows registry. Backup and recovery of the All save set includes the SYSTEM STATE or VSS SYSTEM BOOT save set, which includes the registry.

Note: Attempting to restore a Windows NT 4.0 registry save set to a computer that is running Windows Server 2003 or later will yield unpredictable results.

Sparse files

The NTFS sparse files feature enables a program to create huge files without actually committing disk space for every byte. The NetWorker software provides complete backup and recovery support for sparse files.

Windows Change Journal

Microsoft Windows Change Journal is a Windows Server 2003, and Windows XP Professional file system feature that logs a record of each change as it occurs to the files and directories on a local NTFS 5.0 volume.

The Change Journal enables NetWorker software to detect more types of changes and save more changed files than is possible when not using the Change Journal. Additionally, the Change Journal improves NetWorker performance.

The Change Journal can be enabled or disabled independently for each NTFS 5.0 volume. When enabled, the Change Journal stores records of the volume's file and directory changes in System Volume Information\tracking.log.

Note: When VSS is used, the Microsoft Change Journal is not used. Microsoft Windows Vista and Windows Server 2008 are VSS only, so Windows Vista and Windows Server 2008 do not use the Windows Change Journal.

NetWorker support for Change Journal

Windows does not have an administrative interface for enabling or disabling the Change Journal. That functionality is provided with the NetWorker Change Journal Manager.

The NetWorker Change Journal Manager is installed during the NetWorker software setup and can be run from **Start>Programs>NetWorker**.

The NetWorker Change Journal Manager allows you to:

- ◆ Enable or disable the Change Journal for each NTFS 5.0 volume.
- ◆ Enable or disable the NetWorker software's use of each volume's Change Journal.
- ◆ Set parameters that control the size of the Change Journal log file.

How NetWorker software uses the Change Journal

When configured to use the Change Journal, the NetWorker software bases its save decisions for level and incremental backups on the Change Journal log rather than on the traditional save criteria of modification time and Archive attribute.

[“Backup levels” on page 147](#) provides information about level and incremental backups.

Note: The NetWorker software does not use the Change Journal for the following types of backups:

- ◆ Full backups
- ◆ Client-initiated backups
- ◆ Backups with an undefined level
- ◆ DFS backups
- ◆ VSS file system backups
- ◆ Backups of pseudo-volumes, such as the SYSTEM save sets

The Change Journal is only used when the NetWorker **save** command's path argument specifies an entire volume (for example, C:\ but not C:\MyDir). The time a change occurred continues to control the file save decision.

For a file to be selected for backup, it must have changed more recently than the *changed after time* (also called the *as of time*), as specified in the NetWorker **save** command's **-t** argument. The *EMC NetWorker Command Reference Guide* or the UNIX man page provides information about the NetWorker **save** command.

NetWorker save criteria when using the Change Journal

A NetWorker save that uses the Change Journal occurs when *all* of the following conditions are met:

- ◆ The target volume is NTFS 5.0.
- ◆ The Change Journal is enabled on the target volume.
- ◆ The NetWorker software is configured to use the Change Journal on the target volume.
- ◆ The save path is the entire volume (for example, C:\).
- ◆ The save set is a level or incremental backup.
- ◆ One or more of the save triggers occurs.

Table 121 shows the NetWorker save triggers when using the Change Journal.

Table 121 NetWorker save triggers

Change	Trigger
A file was deleted (or moved to another directory).	Save of the deleted file's directory.
A directory was deleted.	Save of the parent directory.
A directory was renamed.	Save of all files and subdirectories within the directory.
A file or directory was compressed or decompressed.	Save of the file or directory.
A file or directory was encrypted or decrypted.	Save of the file or directory.
The NTFS-extended attributes of a file or directory were changed.	Save of the file or directory.
The access rights of a file or directory were changed.	Save of the file or directory.
An NTFS hard link was added to or removed from a file or directory.	Save of the file or directory.

Configuring NetWorker software to use the Change Journal

The NetWorker Change Journal Manager enables one to view or edit the Change Journal configuration of each volume in the NetWorker server or client host computer.

How to configure NetWorker software to use the Change Journal

To view or edit the Change Journal configuration:

1. On the NetWorker server or client host computer, select **Start>Programs>NetWorker>NetWorker Change Journal Manager**.
2. In the **NetWorker Change Journal Manager** dialog box, select one of the following:
 - All NTFS Volumes — to view or edit the Change Journal configuration of all local NTFS 5.0 volumes at once.
 - A drive letter — to view or edit the Change Journal configuration of an individual volume.

Note: The status of the selected volume or volumes appears in the scrolling text box. If a selected volume does not support the Change Journal (FAT volumes, for example) the configuration options are dimmed.

3. To enable the Change Journal for use with NetWorker software, ensure that the **NetWorker Uses Change Journal** checkbox is selected. To disable the Change Journal, ensure that this checkbox is clear.

If you select **All NTFS Volumes**, and some (but not all) of the local NTFS 5.0 volumes already have this option enabled, the checkbox appears shaded. To change the setting of this option for all NTFS 5.0 volumes, click the checkbox until it is selected or clear, but not shaded.

4. To enable the Change Journal for use with Microsoft, select the **Enable Change Journal For Selected Volumes** checkbox.
 - To disable the Change Journal, ensure that this checkbox is clear.

- If you select **All NTFS Volumes**, and some (but not all) of the local NTFS 5.0 volumes already have this option enabled, the checkbox appears shaded.
- To change the setting of this option for all NTFS 5.0 volumes, click this box until it is selected or clear, but not dimmed.

Note: When you enable the Change Journal, there may be a delay of several minutes before logging begins.

5. Edit the following values to control the size of the Change Journal log file. If the Change Journal is already enabled for the selected volume or volumes, disable it before changing either of these values.
 - **% Of Volume For Log File** — The maximum amount of the volume's storage space that can be used for the Change Journal log file. The allowable range is 0.01% to 2.0% of the volume's capacity.
 - **% Of Log For Allocation Delta** — The amount by which the Change Journal log file can expand if additional space is needed. This is also the amount that will be purged from the beginning of the log when the file has reached its maximum size. The allowable range is 12% to 25% of the % Of Volume For Log File.
6. Click **Apply** to save any configuration changes.
7. Click **OK** to exit **NetWorker Change Journal Manager**.

Advanced Configuration and Power Interface

NetWorker software supports the following:

- ◆ Windows Server 2003
- ◆ Windows XP Professional
- ◆ Power Interface (ACPI), which is also called OnNow

NetWorker support for ACPI

Support for ACPI is provided by the *NetWorker Power Monitor* service. The executable for this service (<NetWorker_install_path>\bin\nsrpm.exe) is installed and configured for automatic startup during NetWorker setup.

For scheduled backups of Windows Server 2003, and Windows XP Professional clients, each client must be able to respond when a NetWorker server contacts it for backup. Therefore, by default, the NetWorker Power Monitor service does not allow a NetWorker server or client host operating system and its network interface to enter the ACPI standby mode.

However, the NetWorker Power Monitor service does not prevent a user from specifying that a computer can power down to standby state. Also, if line power is lost and the uninterrupted battery power reaches a critically low state, the NetWorker software does not prevent the host's power-management policies from forcing the system to power down. The NetWorker software shuts down any storage management operation that is in progress when standby is forced by a user action or a critical power event.

Considerations for ACPI usage

Before using ACPI, review the following conditions:

- ◆ Do not place a NetWorker server host or client host in standby mode during a time period when either computer is to participate in a scheduled backup.
- ◆ Do not put a NetWorker client or server host in standby or hibernation mode *while* a NetWorker backup or restore operation (involving that host) is in progress. Doing so will yield unpredictable results.
- ◆ If a NetWorker server is powered down while NetWorker operations are in progress, the server's peripheral devices might be powered down as well.

If this occurs, when the server's power is restored, the tape devices may rewind and NetWorker's tape processes will have incorrect positioning information.

Windows print queues

The following considerations apply to Windows print queues:

- ◆ Print queues are backed up and recovered as part of the file system and not as part of any VSS writer.
- ◆ During a recover operation, you may have to reboot depending on the status of the print queue.

This appendix covers these topics:

◆ Solaris.....	746
◆ Linux	748
◆ HP-UX.....	749
◆ AIX.....	754
◆ HP Tru64 UNIX	754
◆ IRIX.....	756

Solaris

This section provides information specific to NetWorker software that runs on the Solaris platform.

Support for Solaris zones

The NetWorker software provides support for local and global zones for a NetWorker client, server, and a dedicated storage node. You can install and back up a NetWorker client, server or storage node on a machine running in a local zone. [“Dedicated storage nodes” on page 102](#) provides more information about storage node support in a local zone.

Note: The NetWorker Console (NMC) and the NetWorker License Manager can only be installed in a global zone.

NetWorker executables not found for Solaris client

On Solaris, NetWorker executables are installed by default in `/usr/sbin`. If you start a group backup on a NetWorker server that does not have `/usr/sbin` in the search path for root, the backup fails on a client that has its NetWorker executables in `/usr/sbin`. This is because the `savefs` command is not in the search path.

To solve this issue, set the **Executable Path** attribute for the client.

How to set the Executable Path attribute

To set the Executable Path attribute:

1. From the **Administration** window, click **Configuration**.
2. In the expanded left pane, select **Clients**.
3. In the right pane, select the client name.
4. From the **File** menu, select **Properties**.
5. For the **Executable Path** attribute on the **Globals 2 of 2** tab, enter the path of the executables, `/usr/sbin`.
6. Click **OK**.

Alternate solution: Modify the search path for root on the NetWorker server to include `/usr/sbin` even if it does not exist locally.

How to obtain support for devices not supported by Solaris

For devices that are not directly supported by Sun Microsystems for use with your operating system, obtain a `st.conf` file from the device manufacturer.

Extended file attribute data included in Save Set File Size attribute

The save set file size shown in NetWorker appears to be slightly larger than one might expect. This is because the extended file attribute data is included in the calculation of the save set file size.

The inquire command and Solaris 10

On Solaris 10, the **inquire** command does not show library information after the library has been configured for NetWorker.

Linux

This section provides information about NetWorker software that runs on the Linux platform.

Backup considerations for Linux raw disk partitions

The following considerations apply to backing up Linux raw disk partitions:

- ◆ The Linux raw device must be unbound before it can be saved.
- ◆ The save set must be `/dev/sd` or `/dev/hd`.
- ◆ The backup will fail if the `/dev/raw` device is used.

Configure Linux operating system to detect SCSI devices

Proper configuration of the SCSI subsystem is required to get full use of SCSI devices and allow the operating system to detect SCSI devices attached to the computer. If the device is configured with multiple LUNs, set the kernel parameter **Probe all LUNs of each SCSI Device** to **Yes**. The *Linux Documentation Project* website provides more information on configuring the Linux SCSI subsystem. For information on the SCSI device, contact the manufacturer.

Configuration requirements for the inquire command

Depending on the specific OS requirements, and the configuration of the NetWorker server or storage node, device files may need to be created so that the **inquire** command can detect all devices.

For example, on a NetWorker server that is running Red Hat Linux, if devices `sg0` through `sg15` already exist, create device file `sg16` by using the **mknod** program as follows:

```
mknod /dev/sg16 c 21 17
```

The operating system vendor documentation provides more information on creating devices.

Linux Journaled file system support

Backup and recovery operations are supported on the following Linux journaled file systems:

- ◆ `ext3`
- ◆ `reiserfs`
- ◆ `jfs`
- ◆ `xf`

Note: For `ext3` file systems with the journal set to visible, do not back up or recover the journal. Recovering the journal may cause the file system to become unstable. Use a directive to ensure that this file system is excluded from a backup. [Chapter 6, "Directives"](#) provides information about directives.

HP-UX

This section provides information specific to NetWorker software that runs on the HP-UX platform.

Autochanger installation on an HP-UX system

The following sections explain how to install and configure Hewlett-Packard drivers.

Selecting SCSI addresses for the autochanger

Determine which SCSI address is assigned to each SCSI bus and select the SCSI addresses to be allocated to the autochanger drives and controller.

To select unused SCSI addresses for an autochanger:

1. Log in as root on the NetWorker server or storage node and enter the **ioscan -f** command.
2. Use a SCSI address within the range of 0 to 6. The primary hard disk is usually on SCSI address 6.

Note: For some devices, such as the HP Model 48AL autochanger, select one SCSI address for the entire autochanger. The 48AL uses a different SCSI logical unit number (LUN) for the device (LUN 0) and robotics (LUN 1). The SCSI LUN appears as the last digit of the H/W Path field in the **ioscan** output.

The following sections provide examples of the command and output to use with different combinations of hardware and operating systems.

Installing the SCSI pass-through driver

The following procedure describes how to install a GSC, HSC, or PCI pass-through driver.

How to install a GSC, HSC, or PCI pass-through driver

The following procedure assumes you are using the SAM terminal mode.

To install a GSC, HSC, or PCI pass-through driver:

1. Run **SAM**.
2. Select **Kernel Config** and press **Enter**.
3. Select **Drivers** and press **Enter**.
4. Select SCTL from the list. The SCSI_ctl driver is represented by the name SCTL.
 - If the current state is in, proceed to [“How to verify a device file” on page 750](#).
 - Select any unreserved name for the device. For example, do not select a name such as /dev/null.
5. From the **Actions** menu, select **Add Drivers to Kernel** and press **Enter**.
6. From the **Actions** menu, select **Create a New Kernel** and press **Enter**.
7. When prompted with “Are you sure?” indicate Yes, and press **Enter**.
8. The **Creating Kernel** message appears, followed by the Move Kernel Message. Select **OK** and press **Enter**. The system reboots.
9. Proceed to [“How to verify a device file” on page 750](#).

How to verify a device file

To verify a device file:

1. Verify that the *spt* was successfully installed with the following command:

```
ioscan -kfn
```
2. Verify that the driver has claimed the autochanger. If the autochanger has been claimed, CLAIMED should appear under the S/W State header. If not, verify that the installation has been completed properly.
3. If the device entry was defined by the operating system, use the OS-defined entry and proceed to verify the installation.

Major number

To determine the value for *majornum*, type the following commands:

```
lsdev -d sctl
```

The output should resemble the following. The assigned number may differ from those displayed in this example:

Character	Block	Driver	Class
HP-PB	75 -1	spt	spt
HSC or PCI	203 -1	sctl	ctl

The value for *majornum* is the number in the Character column.

Minor number

To determine the value for *minornum*, use the **ioscan** command. The relevant lines in the **ioscan** output are those:

- ◆ For the controller itself (which contains HP C6280-7000 in the Description column).
- ◆ For the adapter to which the controller is connected (which is the second line above the line for the controller and contains "ext_bus" in the Class column).

If the schgr driver is configured on the system, it appears associated with the library. The **ioscan** output line resembles:

Class	I	H/W Path	Driver	S/W State	H/W Type
Description					
spt	0	10/4/4.6.0	schgr	CLAIMED	DEVICE HP
C6280-7000					

If the schgr driver is not configured on the system, no driver appears to be associated with the library. The **ioscan** output line resembles:

Class	I	H/W Path	Driver	S/W State	H/W Type
Description					
unknown	-1	10/4/4.6.0	schgr	UNCLAIMED	DEVICE HP
C6280-7000					

How to test the device driver and device file installation

After the device driver is installed and the device file is created, run the **inquire** command to list available SCSI devices:

```
inquire
```



IMPORTANT

Use the inquire command with caution. Running inquire sends the SCSI inquiry command to all devices detected on the SCSI bus. Using inquire during normal operations may cause unforeseen errors and possible data loss may result.

An example of the output from this command (with the **-s** option) is as follows:

```
scsidev@0.1.0:HP C1194F 0.14Autochanger (Jukebox), /dev/rac/c0t1d0
scsidev@0.2.0:Quantum DLT4000 CC37Tape, /dev/rmt/c0t2d0BESTnb
scsidev@0.3.0:Quantum DLT4000 CC37Tape, /dev/rmt/c0t3d0BESTnb
scsidev@0.4.0:Quantum DLT4000 CC37Tape, /dev/rmt/c0t4d0BESTnb
scsidev@0.5.0:Quantum DLT4000 CC37Tape, /dev/rmt/c0t5d0BESTnb
```

Inquire command does not detect tape drive

When you attach a Tape drive to the HP-UX 11i V2 64-bit host and run the inquire command, the tape drive is not detected, even if the device is configured, labeled and mounted and a save was successful.

Workaround

Identify the drive path in the `/dev/rmt` folder, and using this path configure the device, as usual.

Whenever a new device is attached to the system, ensure that the cached file `/tmp/lgt0_scsi_devlist` is updated. Remove this temp file and then run the inquire command, which will rebuild the file.

The “Hardware address not found” message

The HP-UX system configuration logger may generate the error message:

```
bootpd pid# Hardware address not found hardware-address
```

A similar message is written to the NetWorker `/nsr/logs/messages` file. If this error message appears:

1. Log in as root and edit the `/etc/syslog.conf` file to change every instance of `daemon.notice` to `local7.notice`.
2. Edit the **Log Default** notification in the **Notification** resource to change the value for the **Action** attribute:

- Change `daemon.notice` to `local 7.notice`.

3. Apply and save the changes to the **Log Default** notification.
4. Enter this command:

```
cat /etc/syslog.pid
```

5. Use the PID number obtained from the `/etc/syslog.pid` file to kill the designated PID number and cause the **syslogd** daemon to reread its configuration file:

```
kill -HPU pid#
```

The `local7` facility is provided as an example.

6. View the `syslog.h` system header file to determine other possibilities for the facility.
 - By default, `LOG_LOCAL0` to `LOG_LOCAL7` are reserved for local use.

- If they are not used by other local utilities on the system, the NetWorker server can use them to avoid the hardware address problems encountered with **bootpd**.

Errors from unsupported media in HP tape drives

Certain HP tape drives can only read 4-mm tapes of a specific length. Some, for example, read only 60-meter tapes. To determine the type of tape that is supported, refer to the drive's hardware manual.

If unsupported media is used, the following types of error messages may appear in the specified situations:

- ◆ When the **nsrmm** or **nsrjb** command is used to label the tape:

```
nsrmm: error, label write, No more processes (5)
```

- ◆ When the **scanner -i** command is used:

```
scanner: error, tape label read, No more processes (11)
scanning for valid records ...
read: 0 bytes
read: 0 bytes
read: 0 bytes
```

Unloading tape drives on an HP-UX server or storage node

When the **nsrjb -u -S** command is used to unload a tape drive in an autochanger attached to an HP-UX server or storage node, all of the tape drives inside the autochanger are unloaded to their respective slots. To unload a single drive to its corresponding slot, use the **nsrjb -u -f devicename** command instead.

SCSI pass-through driver required for HP-UX autochangers

If an autochanger with a NetWorker HP-UX server is used, refer to the *NetWorker Installation Guide*. Read the required procedures to follow before the **jbconfig** program is run. Even if the SCSI pass-through driver is installed, follow the procedures to rebuild the kernel. Then run the **jbconfig** program to configure the autochanger.

Symbolic link entries in the fstab file

For HP-UX operating systems, do not use symbolic entries in the `/etc/fstab` file. If symbolic links are used in the `fstab` file, the NetWorker server will *not* back up the file system that the symbolic link points to.

Font warnings when exporting display to a Solaris computer

If the NetWorker motif-based graphical interface (**nwrecover**) is being run on an HP-UX computer and exporting the display to a Solaris computer, the motif application may fail to open and the following warnings may appear:

- ◆ Warning: Missing charsets in String to FontSet conversion
- ◆ Warning: Cannot convert string *string* to type FontSet

If this occurs, set the LC_CTYPE environment variable on the HP-UX computer to the value C.iso88591. For example, from an xterm window, telnet to the HP-UX computer and run the following command: **export LC_CTYPE=C.iso88591**

The **nwrecover** should work correctly when this environment variable is set. Add this environment variable setting to your .profile on the HP-UX computer.

Customized backup scripts

On HP-UX, do not use the posix shell (/bin/sh) for customized backup scripts that are meant to be automatically started by the savegroup. Use the korn shell instead (/bin/ksh).

AIX

This section provides information specific to NetWorker software that runs on the AIX platform.

STK-9840 drives attached to AIX

If you attach an STK-9840 drive to an AIX server, use SMIT to modify the IBM tape drive definition field to set the value of Use Extended File Mark to Yes.

LUS driver operation on AIX

The operation of the LUS driver on AIX has been changed with NetWorker release 7.6 SP2. When a library comes online, NetWorker now obtains an exclusive lock on the library. This lock is maintained as long as the library is enabled. As a result, diagnostic tools such as **inquire** and the **sjj** utilities cannot be used to access the library during this time. To access the library using these tools, it will be necessary to take the library offline.

HP Tru64 UNIX

This section provides information specific to NetWorker software that runs on the HP Tru64 UNIX platform.

Select the port range

To select the port range:

1. Log in to the NetWorker server and each cluster node.
2. Use the **nsrports** command to select a unique service port range. For example:
 - On Cluster node A, change the port range to 7937-8936:
nsrports -S 7937-8936
 - On Cluster node B, change the port range to 8937-9936:
nsrports -S 8937-9936
3. Shut down and restart the NetWorker software on all nodes.

Restoring context-dependent symbolic links

NetWorker software does not correctly handle the restoration of files in a path that contains CDSLs. This problem exists when a file is backed up through a path that incorporates a CDSL embedded in the middle of a pathname. The file is backed up, but the save set cannot be restored or browsed because the file path is ambiguous on the tape.

Currently, two workarounds are available:

- ◆ Restore by using the full pathname for any paths containing CDSLs.
- ◆ Specify a directory above the CDSL during the backup and restore. For example:
 - If the mount point `/cluster/members/(memb)/ptmp` is backed up, then the files in `/ptmp/fred` are written to tape, but are not accessible.

- To work around this problem, replace the <memb> with the real value of memberN (N is the node number).
- You can also save /cluster/members and /cluster/members/memberN/ptmp, which saves both the CDSLs and the data to which they point.

[Chapter 2, “Backing Up Data”](#) provides information about backups. [Chapter 13, “Recovering Data”](#) provides more information about recovering data.

IRIX

This section provides information specific to NetWorker software running on the IRIX platform.

IRIX displays a “no space left in tape” message

If an IRIX NetWorker server or storage node is used, the following message may appear if the tape drive is not configured within the machine’s kernel:

```
BSF invalid argument no space left in tape
```

This is not a NetWorker error. Ensure that the device is supported and configured by applying the latest kernel patch from the Silicon Graphics.

Go to the SGI Services and Support website for the required patches and information about the current drives, robotics, and firmware revisions that IRIX supports.

This appendix covers these topics:

- ◆ Support for Mac OS X..... 758
- ◆ Mac OS X backup considerations 758
- ◆ Recovering files and directories on Mac OS X using the command prompt 760
- ◆ Recovering files and directories on Mac OS X using NetWorker Recover 761

Support for Mac OS X

This section describes NetWorker client support for the Mac OS X platform. Mac hosts can be set up as NetWorker clients by using the NetWorker client for Mac OS X. Mac hosts that are set up as NetWorker clients can be backed up and restored by using any supported NetWorker server on UNIX, Linux, or Windows. Currently the NetWorker server and the Console server are not supported on Mac OS X.

Mac OS X metadata support

The NetWorker client on Mac OS X supports backup and recovery of all file system metadata including:

- ◆ Finder information
- ◆ Resource forks
- ◆ Extended attributes (Mac OS X 10.4)
- ◆ Access Control Lists (Mac OS X 10.4)

Supported file systems

The NetWorker client for Mac OS X software supports these file systems:

- ◆ HFS+ (including journaled)
- ◆ HFS
- ◆ UFS

Mac OS X backup considerations

Use this section to help plan successful backups for NetWorker clients on the Mac OS X platform.

Scheduling a NetWorker client backup on Mac OS X

This section provides information on configuring backups for a NetWorker client on Mac OS X.

MAC OS X required directives

To ensure a consistent state after recovery, certain files and directories must not be backed up on Mac OS X systems.

To ensure that appropriate files and directories are not backed up:

1. Create or edit the Mac OS Client resource. [“Task 6: Create a backup Client resource” on page 59](#) provides information about creating a Client resource.
2. Select one of these directives from the Directive attribute list:
 - Mac OS Standard Directives
 - Mac OS with Compression Directives

[“Preconfigured global directive resources” on page 174](#) provides more information about Mac OS directives.
3. Click **OK**.

[“Scheduled backups” on page 54](#) provides more information about scheduling a backup.

Backing up Mac OS X server’s open directory for disaster recovery

This section describes how to back up the Mac OS X Server’s Open Directory. Open Directory contains system configuration information that is essential for disaster recovery. The *NetWorker Disaster Recovery Guide* provides more information about disaster recovery.

Note: The NetWorker Mac OS directives do not back up Open Directory database files.

To ensure complete protection of a Mac OS X Server system in the event of a catastrophic failure:

1. Use the **savepnpc** script to automatically export and backup the required Open Directory database files.
2. Open Directory database files remain available during the backup.

To automatically back up Open Directory files:

1. Enter **savepnpc** in the Backup Command attribute when configuring the Mac OS X client as a NetWorker Client resource.

[“Using the savepnpc command with a customized backup program” on page 91](#) provides more information about enabling the Client resource to use the **savepnpc** command.

2. Create a custom **savepnpc** script in the `/nsr/res` directory with the name `<group_name>.res`.

where `<group_name>` is the Group that was selected for the Client resource.

3. Include entries in the **savepnpc** script to perform these functions:
 - Back up Open Directory’s LDAP directory domain:

```
# slapcat -l /var/backups/networker.ldif
```
 - If your LDAP server uses SSL, back up Open Directory’s Password Server database:

```
# mkdir -p /var/backups/networker.odpdb
# mkpassdb -backupdb /var/backups/networker.odpdb
```
 - Back up the local NetInfo directory domain:

```
# nidump -r / . > /var/backups/networker.nidump
```

Example 50 Custom savepnpc script for Mac OS X

A Mac OS X NetWorker client that belongs to the Default group will have a `/nsr/res/Default.res` script with this content:

```
type: savepnpc;
precmd: "/usr/sbin/slapcat -l /var/backups/networker.ldif;
/bin/mkdir -p /var/backups/networker.odpdb;
/usr/sbin/mkpassdb -backupdb /var/backups/networker.odpdb;
/usr/bin/nidump -r / . > /var/backups/networker.nidump"
```

In this script, the **savepnpc** command backs up Open Directory’s LDAP directory, Password Server, and NetInfo databases before each scheduled save.

Performing a manual backup on Mac OS X

Manual backups for Mac OS X clients must be performed from the command prompt. To perform a manual backup, use the **save** command, in a Terminal session, as follows:

```
$ save "file_or_directory_to_back_up"
```

By default, the **save** command contacts the NetWorker server defined in the `/nsr/res/servers` file that comes first in alphabetical order.

To specify an alternative NetWorker server, use the **save** command with the **-s** *NetWorker_server* option.

Recovering files and directories on Mac OS X using the command prompt

These sections provide information on recovering individual files and directories from a NetWorker client on Mac OS X from the command prompt:

- ◆ [“Task 1: Browse backed-up Mac OS X data” on page 760](#)
- ◆ [“Task 2: Recover individual files or directories” on page 760](#)

Each task in this section uses the **recover** command. The *NetWorker Command Reference Guide* and UNIX man pages provide more information about this command.

Task 1: Browse backed-up Mac OS X data

To browse backed-up Mac OS X data:

1. From the Mac OS X Terminal application, start a recover session with a NetWorker server by using this command:

```
$ recover
```

By default, the **recover** command contacts the NetWorker server defined in the `/nsr/res/servers` file that comes first in alphabetical order. To specify an alternative NetWorker server, use the **recover** command with the **-s** *NetWorker_server* option.

2. At the recover prompt, browse backed-up Mac OS X data by using common UNIX shell commands such as **cd** and **ls**.

Task 2: Recover individual files or directories

To recover individual files or directories from the client's **recover** prompt:

1. At the **recover** prompt, add all the directories and files to be recovered, by using the **add** command, for example:

```
recover> add directory_name
```

2. (Optional) To automatically overwrite existing files, enter the **force** option at the recover prompt.
3. Start the recovery by typing this command:

```
recover> recover
```

Do not recover any Mac OS X operating system boot files. For example do not recover the Mac OS X operating system kernel, `/mach_kernel`.

Recovering files and directories on Mac OS X using NetWorker Recover

Available for Mac OS X starting with NetWorker release 7.6 SP3, NetWorker Recover is the client interface program that can be used to recover files from a NetWorker server. As a NetWorker client, your computer can connect to a server to recover files and save sets.

Starting NetWorker Recover for the first time

When starting NetWorker Recover for the first time, the **Connect to Server** dialog appears.

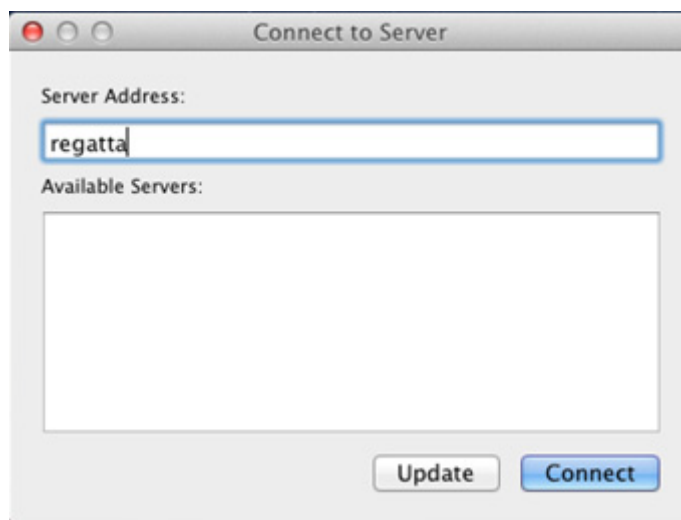

In the dialog, you have the option to manually enter the server address, or select a server from the list of Available servers. This list is generated from the hostnames in the `/nsr/res/servers` file.

If no servers are found in the `/nsr/res/servers` file, you can build a list of servers on the network by entering the server address and clicking **Update** in the Connect to Server dialog.

Once you have selected the server, click **Connect** to initiate a browse session for the local host.

After a successful connection, the NetWorker Recover window appears.

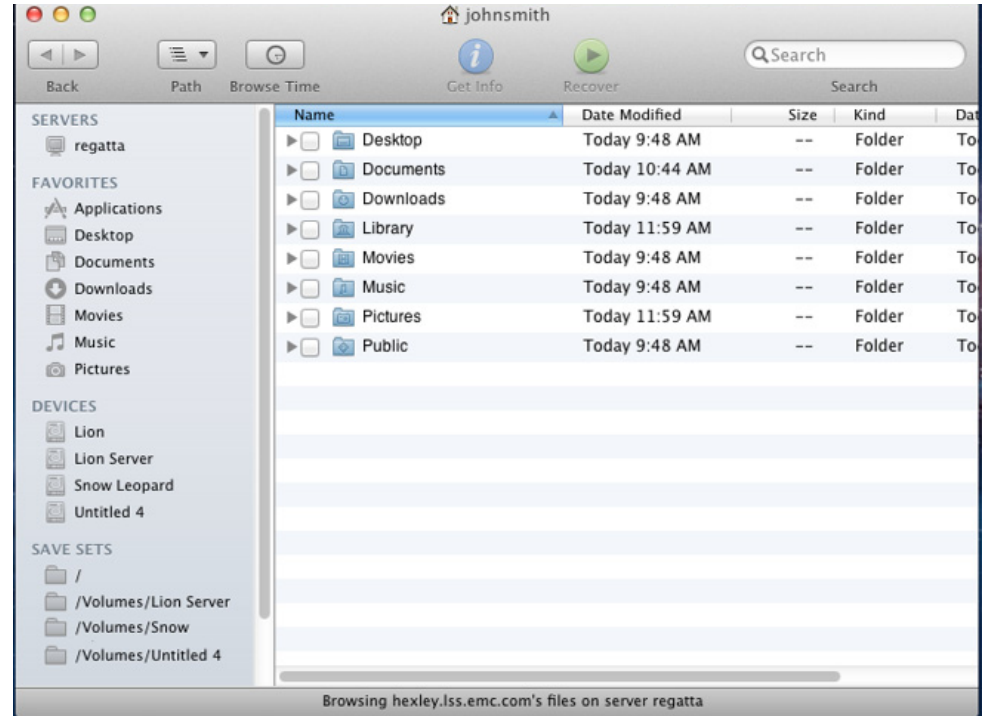

Navigating the NetWorker Recover window

The NetWorker Recover window consists of a browse session view, along with the following menu commands and toolbars.

Menu Commands

The following menu commands are available in the NetWorker Recover window.

- ◆ **File > Get Info** - displays an information dialog of the selected view object
- ◆ **File > Recover** - initiates a recover command
- ◆ **File > Required Volumes** - when file indices or save sets are marked for recovery, selecting this command launches a dialog that displays which volumes are required to recover those files
- ◆ **File > Find...** - when selected, this command will switch the browser view to the index search view
- ◆ **Edit > Mark/Unmark File for Recover** - toggles the mark of a selected file or save set
- ◆ **View > Show/Hide Hidden Files** - toggles the visibility of hidden files
- ◆ **View > Show/Hide File Versions** - toggles the visibility of the index versions sidebar
- ◆ **View > Monitor Server** - displays the NetWorker Server Monitor dialog
- ◆ **Go > Browse Time** - sets the browse time to a user supplied date
- ◆ **Go > Browse Client** - initiates a browse session with a different client
- ◆ **Go > Connect to Server** - opens the **Connect to Server** dialog where you can enter the address for the server you want to connect to
- ◆ **Window > Recover Log** - select this command to view the previous recover's log

Toolbar

The following toolbar buttons and options are available for frequently used commands:

- ◆ **Back** - navigate to previously viewed folders
- ◆ **Path** - lists the folders hierarchy of the currently browsed directory
- ◆ **Browse Time** - displays the Browse Time view, along with a field that, when selected, allows you to change the browse time.
- ◆ **Get Info** - opens a dialog displaying information about the currently selected object
- ◆ **Recover** - starts a recover session
- ◆ **Search** - searches file indexes for the given string. When you enter text in the Search field, the Browse session view displays the results. You can then refine the search using the Search filter bar (for example, you can search based on the last backup time, or combine search criteria).

Each control is enabled or disabled based on the browse session's current state. For example, the **Recover** button is only enabled when either file indices or save sets have been marked for recovery.

Browse session view

The NetWorker Recover window browse session view contains two panes, similar to the Mac OS X Finder. The bottom of the window displays a status message that identifies the current state of the browse session (for example, the current connection status, or the number of files marked for recover).

Note: Any object displayed in the sidebar or browser views can have its basic information queried by highlighting the icon and then right-clicking and selecting Get Info from the drop down, by clicking Info on the toolbar, or by clicking **File > Get Info** from the application menu.

Sidebar

The sidebar contains the following:

- ◆ **SERVERS** - displays each previously connected or currently connected server. When a specific server is highlighted, a connection to that server is attempted, if it is not already connected.
- ◆ **DEVICES** - displays each file system backed up by NetWorker
- ◆ **FAVORITES** - displays any entry that has been backed up
- ◆ **SAVE SETS** - displays each unique save set. You can select a save set to reveal each instance of that save set, including cloned save sets, in the browser view.
- ◆ **RECOVER SETS** - All marked file indices and save sets are added to a recover set. There are always two recover sets to separate index and save set recovers.

Folder icons, when expanded, display the folder contents. Folder icons that are double-clicked will refresh the browser session's right pane with its contents.

Selecting a specific server from the **SERVERS** category displays basic information about the NetWorker Server and lists each client configured on that server in the browser view. If the connection to the selected server is active, the **Monitor...** button appears below the computer icon in the Details pane. If the connection to this server is not currently established, the **Connect...** button displays.

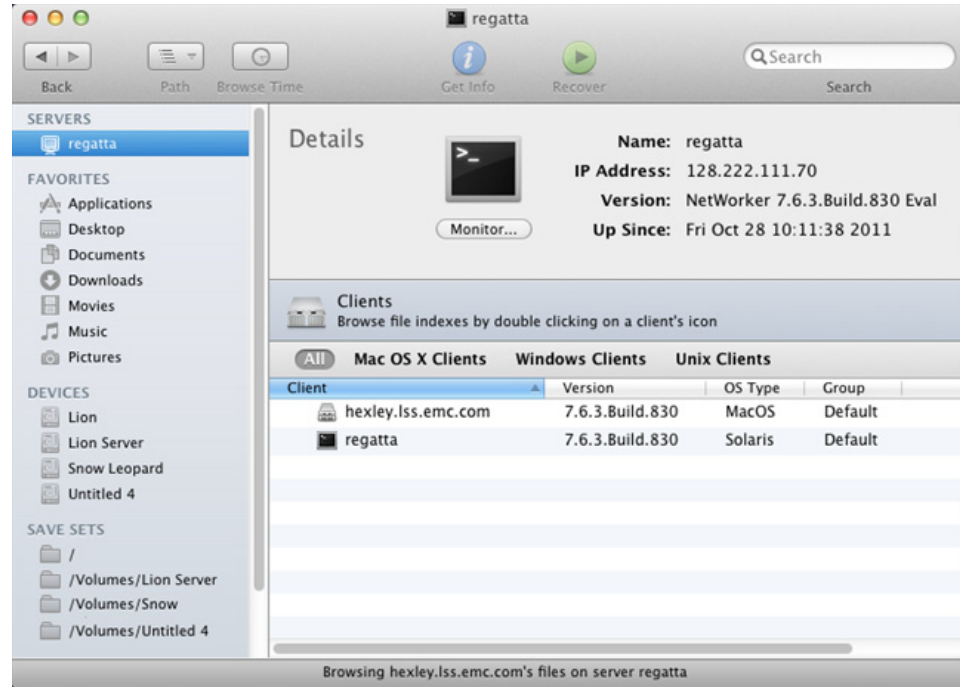

Selecting entries from the **DEVICES** or **FAVORITES** categories display their contents in the browser view.

Selecting a specific save set from the **SAVE SETS** category displays the instances for that save set in the browser view.

Selecting **RECOVER SET** displays all entries marked for recovery in the browser view, as well as summary information for the recover set.

Right pane (browser view)

In the right pane, you can browse and navigate the file index and save sets for categories selected in the sidebar. Files and save sets are presented in the Finder's list view format. The browser lists the following information for file indices and save sets:

File Index includes **Name**, **Date Modified**, **Size**, **Kind**, and **Backup Date**.

Save Sets includes **Save Set ID**, **Save Set Level**, **Save Set Status**, **Size**, **Files**, and **Backup Date**.

Configuring NetWorker Recover

The following sections provide the steps required to configure **NetWorker Recover** to perform a recovery operation using the NetWorker Recover window.

Note: To perform a default recovery, where files from the most recent backup are recovered to their original location using their original filenames, skip to Step 6.

- ◆ [“Changing the NetWorker Client” on page 765](#)
- ◆ [“Changing the NetWorker Server” on page 765](#)
- ◆ [“Step1: Selecting files and save sets for recovery” on page 765](#)
- ◆ [“Step 2: Search for files” on page 766](#)

- ◆ “Step 3: Check the status of required volumes” on page 766
- ◆ “Step 4: Viewing file versions” on page 766
- ◆ “Step 5: Changing the browse time” on page 766
- ◆ “Step 6: Starting the Recovery” on page 766
- ◆ “Monitor the Server” on page 767
- ◆ “Recover logging” on page 767

Changing the NetWorker Server

If the NetWorker server indicated in the Status Bar is not the server you want to recover from, change it to a different host by selecting **Go > Connect to Server** from the menu. The **Connect to Server** dialog displays, where you can select the server from the list of Available Servers and click **Connect**, or enter the address of the server you want to connect to, and click **Update**. You can then select this server from the list of Available Servers, and click **Connect**.

Note: Upon exiting **NetWorker Recover**, the last server connection made is cached in User Preferences.

Changing the NetWorker Client

After selecting the server, to change NetWorker clients, select **Go > Browse Client...** from the menu, and select a client from the drop-down. The Change Client dialog appears.

The client is the computer where the data to be recovered originated from. This dialog lists the hostname of each client computer known to the NetWorker server.

To specify a client as the source for the data you want to recover, select the name of the desired client in the list and click **OK**. A browse session is then initiated for the client.

Clients are displayed in the lower half of the browser view. The Clients filter bar is located above the client names so you can limit the list of clients to a particular view. In the following graphic, the Client filter bar displays All, Mac OS X Clients, Windows Clients, and UNIX Clients.

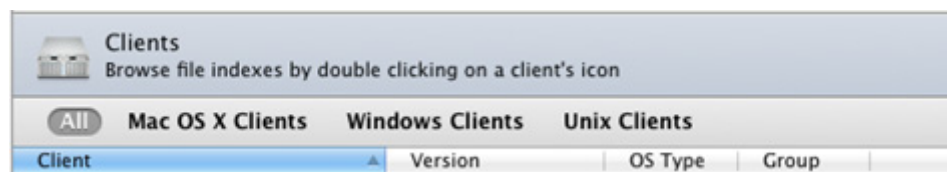

Step 1: Selecting files and save sets for recovery

Select **RECOVER SETS** in the sidebar of the NetWorker Recover window and then select **Files** to display files in the browser view. Mark files for recovery by selecting the checkbox next to each file you want to recover.

Select **SAVE SETS** in the sidebar of the NetWorker Recover window and then select a save set name to display instances of that save set in the browser view. Mark instances for recovery by selecting the checkbox next to each instance you want to recover. Only one instance (or clone) of a save set can be marked for recovery at a time. Save set instances or cloned save sets can be filtered using the save set filter bar, which works similar to the Client filter bar.

Each marked item will be added to **RECOVER SETS** and separated depending on whether the item is a file index or save set. A number next to each **RECOVER SET** in the sidebar displays the number of items selected for recovery. Selecting Files or Save Sets from the **RECOVER SETS** category displays the files or save sets that have been marked for recovery, in addition to summary information related to the **RECOVER SET**.

Step 2: Search for files

If the files you want to recover are not visible in the browser view, you can search for files using the Search field in the top right of the NetWorker Recover window. Entering text in the search field will automatically search the backed up file indices for the text specified in the field. Successful matches are displayed in the browser view.

Search results can be marked for recovery and navigated similar to other browser entries. Once a search result is selected, the path displayed at the bottom of the browser view lists the file's folder hierarchy.

The scope of the search can be controlled by clicking the Search Scope bar. All of the client's indices and the folder currently being browsed are listed as scope options.

You can also specify a folder you want to search for by selecting **Go > Go to Folder...** from the menu and entering the path and name of the folder. The folder then displays in the browser view.

Step 3: Check the status of required volumes

To view the status of the backup volumes required for the recovery operation:

1. Highlight Files under **RECOVER SETS** in the sidebar. The summary information contains the names of any required volumes.
2. Click the **Volume Status** button located to the right of the summary information. The Required Volumes dialog appears.
3. Ensure that the status of the required volume(s) indicates on-line, then close the dialog.

Step 4: Viewing file versions

To view a list of all versions of a selected file, go to View > Show File Versions from the application's main menu. The versions sidebar appears. Selecting a file displays all backed up versions of the file. To recover a specific version of a file, you can drag and drop the file to the browser view, drag the file to a folder for recovery, or right-click the file to select for recovery. The versions sidebar is updated with the selection changes in the browser view.

Step 5: Changing the browse time

If you want to browse or recover files from an earlier backup, the recovery browse time can be changed using several methods:

Browser view context menus - in each browser view, right click on a file index icon to display the **Set Browse Time To...** menu item.

The **Browse Time** toolbar button, when clicked, displays the Browse Time view, displaying the current browse time and the option for later or earlier browse times.

Go > Browse Time displays the Change Browse Time dialog.

Step 6: Starting the Recovery

To start the recovery:

1. From the menu, select **File > Recover**, or click the **Recover** button in the toolbar. The Recover Options dialog appears.
2. In the Recover Options dialog:
 - a. Specify where to relocate the recovered files to
 - b. Select an option for conflict resolution in the event a conflict occurs between a local file and a file being recovered. If you select Prompt me for an action, a prompt will appear each time a conflict is encountered
 - c. Select **Exit** when an error is encountered if you want to stop the recovery when an error occurs
 - d. Select a host from the drop-down to direct the recovery to.
3. Click **OK**.

The recover status dialog appears. At any time during the recovery, you can click the **Stop** button to cancel the operation.

As the recover completes, the progress bar will move towards 100%. Additionally, the name of the current file being restored, the number of files recovered and the size of the recovery are displayed in the dialog.

Monitor the Server

From the recover progress dialog, you can click the **Monitor Server...** button to launch the NetWorker Monitor dialog.

The NetWorker Monitor dialog displays the following tabs:

- ◆ **Info** -- general server information including name, IP, OS type, NetWorker version, Save totals and Recover totals)
- ◆ **Messages** -- server messages logged during the recovery (including errors and warnings)
- ◆ **Devices** -- displays the status for all connected devices
- ◆ **Sessions** -- displays Save sessions, Recover sessions, and Browse sessions
- ◆ **Settings** -- allows you to adjust the polling interval for server updates

Recover logging

When the recovery completes, the success or failure of the operation is reported by NetWorker Recover. You can view the recover log by clicking the Recover Log button. Upon clicking this button, the Console application is launched, displaying the log that was written to the user's ~/Library/Logs/recover.log file.

This appendix covers these topics:

- ◆ Introduction to direct SCSI backup and recover 770
- ◆ System requirements 770
- ◆ Performing direct SCSI backup 771
- ◆ Performing direct SCSI recover 773
- ◆ Licensing..... 776

Introduction to direct SCSI backup and recover

Direct SCSI backup and recover enables direct backup and recover of Small Computer System Interface (SCSI) devices without the requirement of mounting it on the backup host if an access path is available to these devices over a Storage Area Network (SAN). You can also use this feature to migrate to the NetWorker software to perform backup and recover of Business continuance volume (BCV) devices on a Symmetrix server (as well as backup and recover of raw devices) over a SCSI bus.

Backup technologies often protect information as files and directories or as file systems. But backups also allow information contained on raw disks to be protected as raw devices. However, this type of backup (known as raw backup) usually does not provide granular recover capabilities.

The direct SCSI backup and recover feature enables raw backups for the NetWorker software directly by using a SCSI target, which is usually accessible from a SAN proxy host. Typically, in an EMC Symmetrix[®] storage environment, these devices can be viewed from a primary application host and from a proxy backup host. The direct SCSI backup and recover feature allows you to protect BCV devices from a proxy backup host as a raw backup.

System requirements

The direct SCSI feature is only supported on Solaris storage nodes, and you must have EMC Solution Enabler version 5.5 or later installed.

The following hardware devices are supported:

- ◆ Raw device path of a SCSI device
- ◆ Symmetrix device

Note: Be aware that since backup and recover is performed on the proxy client (which is also a storage node), and a Symmetrix device is accessible, data is accessed from the proxy client, which may not be the client that originally created the data.

Unsupported features

If performing backup and recover over a SCSI bus, the following features are not supported with NetWorker release 7.4:

- ◆ Archiving
- ◆ Save set consolidation
- ◆ Index browsing
- ◆ Conventional recovery by using the command line recover utility
- ◆ File-by-file recovery
- ◆ Conventional save set recovery by using the command line recover utility

The EMC Symmetrix device is supported for use with SCSI backup and recover, but no other vendor device is supported with this feature as of NetWorker release 7.4.

Performing direct SCSI backup

When performing Direct SCSI backup, you can perform either of the following:

- ◆ Single device backup
- ◆ Backup of a device set that consists of a list of devices specified in a resource file.

If the device is vendor-specific, the program loads the vendor-specific plug-in shared library.

The NetWorker software uses the `nsrscsi_save` program to start the backup thread for each device to be backed up. Each backup thread performs the following operations:

- ◆ Finds the host accessible raw device path for the given vendor device.
- ◆ Starts a save session with the NetWorker server.
- ◆ Runs `scsi asm` on the raw device path to move data from the SCSI device to a storage node (`nsrmmmd`) by using SCSI commands.



IMPORTANT

Before starting a backup, set the backup device to offline or read-only mode, and the file systems that reside on the device to read-only. If the device is a Symmetrix BCV, keep the BCV detached from the standard during the backup.

Backing up data on a Symmetrix BCV device

To back up data on a Symmetrix BCV device:

1. Create the `.res` file (for example, `/nsr/res/deviceset.res`) if performing backup on a device set. Within the file, do the following:
 - a. Specify a list of devices to be backed up as part of a device set. Associate the device set with each entry in the file. You can identify the devices by their Symmetrix volume IDs (SYMMIDs) and category names, as in the following example:

```
000182504581/011 ## These two will be
000182504581/012 ## grouped as OracleDisks
# This is a comment line
000182504581/07D ## These two will be
000182504581/07E ## grouped as ExchDisks
```
 - b. Store this file in the `nsr/res` directory on the storage node.
2. For the AppHost or the host that controls the data, perform either of the following steps:
 - Create a new NetWorker Client resource. [“Task 6: Create a backup Client resource” on page 59](#) provides more information.
 - Edit an existing client by right-clicking the client in the in the **Configuration** screen of the **Administration** window and selecting **Properties**.
3. For the **Save Set** attribute, do one of the following:
 - If performing multiple device backup, type the following:

```
<<emc_symm>>/{deviceset.res}
```

where `<<emc_symm>>` is the name of the device and `{deviceset.res}` is the name of the `.res` file.

- If performing single device backup without the .res file, type the following:

```
<<emc_symm>>
```

where <<emc_symm>> is the name of the device.

4. On the **Apps and Modules** tab, select **SCSI** for the **Proxy backup type** attribute.
5. In the **Proxy Backup host** attribute, enter the name of the storage node on which the `nsrscsi_save` command will be run.
6. Click **OK**.

Once you create the Client resource, the `nsrscsi_save` program reads the .res file for all the device IDs listed or reads the ID for the single device, and starts the backup thread. The backup thread performs the following:

- ◆ validates the SYMMIDs
- ◆ finds the host-accessible raw device path for the SYMMIDs
- ◆ starts the save session with the NetWorker server.

The NetWorker software creates a save set for each category name, but does not create an index for the content within the BCV.

Backing up data on a raw device

The process for backing up raw device data is similar to backing up data on a BCV device. To perform a SCSI backup of a raw device:

7. For the AppHost or the host that controls the data, perform either of the following steps:
 - Create a new NetWorker Client resource. [“Task 6: Create a backup Client resource” on page 59](#) provides more information.
 - Edit an existing client by right-clicking the client in the in the **Configuration** screen of the **Administration** window and selecting **Properties**.
8. For the **Save Set** attribute, type the path for the raw device with the device name. For example, if the device name is `c1t2d0s2` and the path is `/dev/rdisk`, type the following:

```
/dev/rdisk/c1t2d0s2
```
9. On the **Apps and Modules** tab, select **SCSI** for the **Proxy backup type** attribute.
10. In the **Proxy Backup host** attribute, enter the name of the storage node on which the `nsrscsi_save` command will be run.
11. Click **OK**.

Once you create the Client resource, associate it to scheduled group. At the scheduled time, the group starts the `nsrscsi_save` program on the storage node.

The `nsrscsi_save` program starts the backup thread. For a single device backup, a single backup thread is created by `nsrscsi_save`. The program starts the save session with the NetWorker server.

Backing up data from the command line

To perform backup from the command line, run the following command:

```
nsrscsi_save [ -c clientname ] [ -g group ] [ -N save-set-name ]
[ -I input filename ] [ -s server ] [ -b pool ] [-e expiration ]
[ -y retention time ] Path
```

where:

- ◆ *-c clientname* is the client name for starting the save session. The client name is the local host by default. If using the local host, you do not need to specify the client name.

Note: The client-name is not necessarily the host accessible device. For example, a Symmetrix BCV device may be accessible on a different host for backup than the client where the standard device is attached (the client that you want to register the backup against).

- ◆ *-N save-set-name* is the name of the save set. The save set name is the pathname by default. If the pathname is the name of the device set, *-N* is ignored.
- ◆ *-I input-filename* is the filepathname for the file that contains the list of devices to be backed up (for example, */tmp/testdisks.res*). If the input-filename is not specified, then the default input-filename is taken from device-set-name. For example, if the device-set-name is *oracledisks*, the input-filename would be */nsr/res/oracledisks.res*. Also, if *device-set-name* is used in the path but *-I* is not specified, the default location is set to */nsr/res/device-set-name.res*.

Note: The input file should contain only entries for the devices that need to be backed up. Multiple device entries should be separated by a new line. When *-I* is specified, device-set-name should also be specified.

- ◆ Path can be any of the following formats:
 - For a raw device path: */dev/rdisk/c1t2d0s2*
 - For a device-set-name: *{OracleDevices}*

Note: The braces are mandatory to distinguish device-set-name from a single device path.

- ◆ *-g group* is used by **savegrp** and **savefs** to specify the group of the save. It is also used by the NetWorker server to select the specific media pool.
- ◆ *-b pool* specifies a particular destination pool for the save. All the save sessions go to the same pool.

Performing direct SCSI recover

Direct SCSI recover is performed by using the **nsrscsi_recover** program. This program starts the recover thread for each save set to be recovered. From the command line, you can recover single save sets, or multiple save sets specified in a resource file, with a unique destination for each save set. If the device being recovered from is vendor-specific, the program loads the vendor-specific plug-in DLL.

Each recover thread performs the following operations:

- ◆ Finds the host accessible raw device path for the given target vendor device.
- ◆ Starts a recover session with the NetWorker server.
- ◆ Runs `scsi asm` on the raw device path to move data from the storage node (nsrmmmd) to a raw device via SCSI CDB commands.



IMPORTANT

Before starting the recovery, set the backup device to offline or read-only mode from the application host, and the file systems that reside on the device to read-only. If the device is a Symmetrix BCV, keep the BCV detached from the standard during the backup.

Also, note that the data on the target device being used for recovery will be rewritten and the original data will be lost when using the target device ID and raw device path for recovery.

Recovering data to a Symmetrix BCV device

Recovering data on a Symmetrix BCV device must be performed from the command line. You cannot use NMC to perform this function.

To recover a single save set:

1. Perform an `mminfo` query on the device set name, for example:

```
mminfo -avVot -q "name=xxx"
```

The query returns a list of Save Set IDs (SSIDs) that are part of the device set.

2. Find the SSID (for example, 3697521281), and then run the following command:

```
mminfo -aS -q "ssid=3697521281"
```

The list of connected save sets displays. The connected save sets are the save sets that are backed up as part of this device set.

3. Select a save set from this list.
4. If applicable, prepare the target device and retrieve the target vendor device ID. The target vendor device ID can be original.
5. Run the following command:

```
nsrscsi_recover -S ssid -T target device
```

where *ssid* is the ID for the save set being recovered and *target device* is the SYMMID and the device ID (for example, 0034567/0366, where 0034567 is the SYMMID and 0366 is the device ID).

The NetWorker software recovers the contents of the save set to the destination location. The destination location is the original location by default.

To recover multiple save sets:

1. Perform an `mminfo` query on the device set name. For example:

```
mminfo -avVot -q "name=xxx".
```

The query returns a list of Save Set IDs (SSIDs) that are part of the device set.

2. Find the appropriate SSID (for example, 3697521281), and then run the following command:

```
mminfo -aS -q "ssid=3697521281",
```

The list of connected save sets displays. The connected save sets are the save sets that are backed up as part of this device set.

3. Choose the SSIDs from the list of connected save sets (in the following example, the SSIDs are 3697521281 and 3680744065):

```
mminfo -avVot -r "volume,name,savetime(25),ssid" |grep
oraclediskset
scip2b081.legato.com.001 oraclediskset:000187910217/0365 11/21/06
06:14:25 PM 3697521281
scip2b081.legato.com.001.RO oraclediskset:000187910217/0365
11/21/06 06:14:25 PM 3697521281
scip2b081.legato.com.001 oraclediskset:000187910217/0366 11/21/06
06:14:26 PM 3680744065
scip2b081.legato.com.001.RO oraclediskset:000187910217/0366
11/21/06 06:14:26 PM 3680744065
```

4. If applicable, prepare all target devices and retrieve the target vendor device IDs. The target vendor device ID can be the same as the original backup device ID.
5. Create a `.res` file under `/nsr/res` (for example, `/nsr/res/restorelist.res`), and specify an entry for each save set to be recovered.

Note: Each entry in the `.res` file must have an SSID for every save set being recovered, mapped to a target device (SYMMID/Device ID), as in the following example:

```
3697521281=>000187910217/0366
3680744065=>000187910217/0365
```

6. Run the `nsrscsi_recover` command:

```
nsrscsi_recover -I input filename
```

where *input filename* is the name and location of the `.res` file (for example, `nsr/dev/restorelist.res`).

Once you create the Client resource, the `nsrscsi_recover` program reads the `.res` file for all the device IDs listed, and starts the recover thread. The recover thread validates the device IDs, finds the host-accessible raw device path for the IDs, and starts the recover session with the NetWorker server.

Recovering data to a raw device

To recover data on a raw device:

1. Perform an **mminfo** query and select an SSID (for example, 3697521281), as in the following example:

```
mminfo -aVvot
volume  client size level name
ssid save  time    date    time    browse clretent
first    last file  rec  valid    total fl

scip2b081.legato.com.001 scip2b081.legato.com 8839 MB full
/dev/rdisk/c1t1d0s2
3697521281 1164161665 11/21/06 06:14:25 PM 12/21/06 11/21/07
0 9051405795 0 0 3731075692 9051405796 cr
```

2. If applicable, prepare the target device and retrieve the target raw device path. The target raw device path can be the same as the original raw device path.
3. Run the following command:

```
nsrscsi_recover -S ssid -T target device
```

where *ssid* is the ID for the save set being recovered and *target device* is the raw device path (for example, /dev/rdisk/c1t1d0s2).

The NetWorker software recovers the contents of the save set to the destination location. The destination location is the original location by default.



IMPORTANT

The destination path for recover must be specified and it must be a raw device or a vendor device.

Licensing

EMC Solution Enabler version 5.5 or later is required to use the Direct SCSI feature. There are no other licensing requirements for this feature.

This appendix covers these topics:

- ◆ [Access control settings](#)..... 778
- ◆ [Log settings](#) 780
- ◆ [Communication security settings](#) 781
- ◆ [Encrypting backup data](#) 782

Access control settings

Access control settings protect resources against unauthorized access.

User authentication

User authentication settings control the process of verifying an identity claimed by a user when accessing the product.

Default accounts

[Table 122 on page 778](#) describes the default login accounts.

Table 122 Login accounts

User account	Description
root@localhost — for NetWorker server on UNIX platforms	User 'root' on the NetWorker server host is automatically added to the Administrator list.
system@localhost — Windows platforms	User 'root' on the NetWorker server host is automatically added to the Administrator list.
@	All users at all hosts are added to the 'users' attribute of an instance of the 'NSR Usergroup' resource. All privileges associated with that 'NSR Usergroup' instance go to 'all users @ all hosts' with no explicit denial of access.
administrator	Default NMC user. First login procedure forces password change.

Authentication configuration

The NMC Console has two modes of authentication: native mode and LDAP mode. By default, NMC user authentication is set to native mode.

You can set up user authentication in LDAP mode by using the Configure Login Authentication wizard. You can also revert back to native NetWorker user authentication by using the wizard.

[“Managing NetWorker Console server users” on page 406](#) provides more information.

User authorization

User authorization settings control the privileges that are granted to a user when accessing a resource managed by the product.

[“Console Server Management” on page 405](#) describes how to set up users and to control user permissions for the Console server.

[“Managing server access” on page 440](#) and [“NetWorker User Groups” on page 442](#) describe how to set up users and user groups on the NetWorker server.

Component access control

Component access control settings define the control over access to the product by external and internal systems or components.

Component authentication

NetWorker hosts and daemons are authenticated by using the **nsrauth** mechanism, which is available for hosts that run NetWorker release 7.3 or later. The **nsrauth** authentication mechanism is a strong authentication and is based on the Secure Sockets Layer (SSL) protocol provided by the OpenSSL library or RSA BSAFE SSL, depending on the platform.

Each NetWorker host has a **nsrexecd** service, which provides authentication services. Each **nsrexecd** service has its own private key and self-signed certificate for authentication. The private key is generated by **nsrexecd** when it starts. The private key can also be loaded from a file. The corresponding self-signed certificate is generated by the private key. The private key is RSA and is 1024 bits in length. The encryption method that is used once an SSL session is set up is AES-128.

The session information sent over the SSL connection includes:

- ◆ Session keys
- ◆ Session ID
- ◆ User's information
- ◆ User's NetWorker permissions

[“NetWorker authentication” on page 476](#) provides more information about configuring **nsrauth** authentication.

Component authorization

NetWorker uses the contents of the `/nsr/res/servers` file for UNIX or the `Install_path\res\servers` file for Windows, on each NetWorker client to control the client-tasking rights.

The client-tasking rights are the rights to request the execution of a program on another client and may be any of the following:

- ◆ Server that performs an archive request
- ◆ Scheduled backup
- ◆ Another client that requests a directed recover

If the server file is empty, then any NetWorker host can have tasking rights.

- ◆ Add the names of the additional NetWorker servers to the server file so that the client with the tasking rights can back up to other NetWorker servers.
- ◆ Add the client names to the servers file so that other clients can perform directed recovers to the client with the tasking rights.
 - You can add the names of NetWorker servers to the server file during the software installation.
 - To add additional hosts later, use a text editor and add the hostnames to the server file.
 - After adding the additional hosts in the server file, restart the **nsrexecd** on that client to enable permissions for the additional server hosts.

Log settings

A log is a chronological record that helps to examine the sequence of activities surrounding or leading up to an operation, procedure, or event in a security-related transaction from beginning to end.

Log files and their descriptions

[Table 123 on page 780](#) shows the log files location.

Table 123 Log files

Component	Location
Server and client daemons	/nsr/logs/daemon.raw
Server-generated syslog messages and daemon.notice	/nsr/logs/messages
Server-generated syslog messages local0.notice and local0.alert	/nsr/logs/summary
NMC gstd logs	<install path>/logs/gstd.raw
NMC Web Server logs	<install path>/logs/web_output
NMC DB logs	<install path>/logs/db_output

Log management and retrieval

This section explains how to view and manage logs.

Viewing log files

For NetWorker release 7.4 and later, the following log files can be viewed by using the non-interactive command line program, `nsr_render_log` (for UNIX and Linux) or `nsr_render_log.exe` (for Microsoft Windows):

- ◆ Daemon log file: `daemon.raw`
- ◆ gstd log file: `gstd.raw`
- ◆ User log file: `networkr.raw` (for Microsoft Windows only)

[“Viewing log files” on page 663](#) provides information about using the `nsr_render_log` program.

Managing log files

The Console server gstd log file can be managed with the various Console server environment variables. [“Setting environment variables” on page 419](#) provides more information.

The NetWorker server `daemon.raw` log file can be managed with NetWorker server environment variables. [“Message log management” on page 463](#) provides more information.

Communication security settings

Communication security settings enable the establishment of secure communication channels between:

- ◆ Product components
- ◆ Product components and external systems or components

Port usage

[Table 124 on page 781](#) lists all components, protocols, ports, and services.

Table 124 Port usage

Component	Service	Protocol	Port	Description
Service Port Range		TCP	7937 - 9936	This is the default range of ports that all NetWorker daemons should use when they need to start a service. This range can be configured. Since the daemons may start in any order, there is no guarantee that any one daemon will always use any singular port from this range.
nsrd	RPC	TCP		1 from SPR
nsrindexd	RPC	TCP		1 from SPR
nsrmmdbd	RPC	TCP		1 from SPR
nsrmmgd	RPC	TCP		1 from SPR
nsrjobd	RPC	TCP		1 from SPR
nsrexecd	RPC	TCP	7937, 7938	Plus 2 from SPR. Regardless of SPR, nsrexecd always listens to these two ports. 7938 must be allowed through a firewall, either by NetWorker or another portmapping service, or NetWorker will not work.
nsrlcpd	RPC	TCP		Per instance running.
nsrmmmd	RPC	TCP		1 from SPR, per instance running.
NMC Web Server	HTTP	TCP	9000*	Jumpstart to launch NMC
NMC	GSTD	TCP	9001*	Communicates between Java client and main daemon.
NMC SQLAnywhere DB	DB		2638*	Database listening port

Encrypting backup data

Backup and archive data on UNIX and Windows hosts can be encrypted with the AES Application Specific Module (ASM). The AES ASM provides 256-bit data encryption. Backup data is encrypted based on a user-defined pass phrase.

Do not use AES encryption when backing up files that are encrypted using the Microsoft Windows Encrypting File System (EFS).

Encryption for cloud backup data

A cloud backup device can also be set up to encrypt data sent to the cloud. If encryption is already enabled for the NetWorker host and you enable encryption on the cloud backup device, backups will be slower because encryption functions will occur twice. [“Support for cloud backup devices” on page 120](#) provides more information about cloud backups.

This glossary provides definitions for terms used in this guide.

A

ACL (Access Control List)	A list that specifies the permissions assigned to a specific file or directory.
active group	A NetWorker backup group that has its Autostart attribute enabled.
Administrators group	A Microsoft Windows user group whose members have the rights and privileges of users in other groups, plus the ability to create and manage the users and groups in the domain.
agent	A term used by Sun Microsystems to denote a cluster server. Also known as a package (HP-UX), and a virtual server (Microsoft).
annotation	<ol style="list-style-type: none">1. A comment associated with an archive save set.2. A comment associated with an event.
archive	Backing up directories or files to an archive volume to free disk space. Archived data is not recyclable. See also "groom."
archive request	A NetWorker resource used to schedule and manage archiving.
archive volume	A volume used to store archive data. You cannot store archive data on a backup or cloned volume. See also "backup volume." or See "clone volume."
ASM (Application Specific Module)	A program that is used in a directive to specify how a set of files or directories is to be backed up or recovered. For example, compressasm is a NetWorker directive used to compress files.
Atmos	EMC's cloud storage offering.
attribute	A feature, such as an entry field, of a resource. See also "resource."

authentication	The process by which a user or software process is determined to be trusted or not trusted.
authorization	Privileges assigned to users of the Console and NetWorker server.
authorization code	A unique code that unlocks the NetWorker software for permanent use.
autochanger	See "library."
autochanger sharing	See "library sharing."
Auto Media Management	A feature that enables the storage device to automatically label, mount, and overwrite an unlabeled or recyclable volume.
B	
backup	An operation that saves data to a volume.
backup cycle	The period of time from one level full backup to the next level full backup.
backup group	See "group."
backup level	See "level."
Backup Operators group	A Microsoft Windows user group that can log in to a domain from a computer or a server, and back up and restore its data. Backup operators can also shut down servers or computers.
backup volume	A volume used to store backup data. You cannot store backup data on an archive or cloned volume. See "archive volume." or See "clone volume."
base enabler code	See "enabler code."
bootstrap	A save set that is essential for NetWorker disaster recovery. A bootstrap is composed of two components that reside on the NetWorker server: the media database, and the resource database. The bootstrap also provides information that is essential for recovering client file indexes. See "media database." See "resource database." See "client file index."
browse policy	A policy that determines how long backed up data is available for quick access. See "retention policy."
C	
canned report	A preconfigured report that can be tailored by the user.
carousel	See "library."
client	A computer, workstation, or fileserver whose data can be backed up or recovered. See "Client resource."
client file index	A database that tracks every database object, file, or file system that is backed up. The NetWorker server maintains a single client index file for each client. See "file system."
client-initiated backup	See "manual backup."

Client resource	Identifies the save sets to be backed up on a client. The Client resource also specifies information about the backup, such as the schedule, browse policy, and retention policy for the save sets. Multiple Client resources can be configured for one client computer. For example, you could create one Client resource to back up business data and another to back up operating system files. See also "client."
clone	A reliable copy of backed up data. Unlike volumes created with a simple copy command, clone volumes can be used in exactly the same way as the original backup volume. Single save sets or entire volumes can be cloned.
clone volume	A volume used to store clone data. You cannot store clone data on either an archive or a backup volume. See "archive volume." See "backup volume."
cloud	For NetWorker, a cloud refers to an EMC Atmos based configuration of backup disks.
cluster	Two or more nodes that are connected and appear to network users as a single, highly available system.
command-prompt	The shell prompt, where you enter commands.
CIF (Common Internet File System)	Formerly known as Server Message Block (SMB). A message format used by DOS and Windows to share files, directories, and devices.
connection port	A port that NetWorker processes use to perform backup and recovery sessions through a firewall.
Console Application Administrator	A Console server user role whose members can configure features (except security) in the Console sever application.
Console Security Administrator	A Console server user role whose members can add Console users and assign them to Console roles.
Console Server	NetWorker servers and clients are managed from the NetWorker Console server. The Console server also provides reporting and monitoring capabilities for all NetWorker servers and clients.
consolidate	To create a full backup by merging a new level 1 backup with the last full level backup.
continued save set	Save set data that is continued from a previous volume.
control zone	A group of datazones managed by the NetWorker software.
D	
daemon	A process that runs in the background and performs a specified operation at predefined times or in response to certain events.
data retention policy	See "retention policy."
datawheel	See "library."
datazone	A group of computers administered by a NetWorker server.
DDS	See "DDS (Dynamic Drive Sharing)."

device	<ol style="list-style-type: none"> 1. A storage unit that reads from and writes to backup volumes. A storage unit can be a tape device, optical drive, autochanger, or file connected to the server or storage node. <i>See "library."</i> <i>See "server."</i> <i>See "storage node."</i> 2. When dynamic drive sharing (DDS) is enabled, refers to the access path to the physical drive.
Device Central	The interface from which one can manage all NetWorker libraries.
DFS (Distributed File System)	A Microsoft Windows add-on that allows you to create a logical directory of shared directories that span multiple machines across a network.
DFS component	<ol style="list-style-type: none"> 1. A namespace for files and DFS links, called a DFS root. 2. A connection to a shared file or folder, called a DFS child node
DAR (Direct Access Restore)	An NDMP data recovery operation that allows you to recover data in the middle of a tape set without having to parse the tape set sequentially. This reduces recovery time of large backups.
directed recovery	A recovery method used to recover data that originated on one computer to another computer.
directive	Instructions to take special actions on a given set of files for a specified client during a backup.
DMA (Data Management Application)	Initiates a backup or recovery request through the NDMP connection.
document mode	A mode that displays static reports (as charts or tables) in a format that resembles the Print Preview view displayed by a PDF file viewer.
domain controller	A computer that manages user interactions with a domain, including logon, authentication, directory searches, and access to other shared resources.
drill-down reports	Organizes basic report data in terms of granularity. For example, a user could start with group summary data, then "drill down" to data for a client within the group, and then to data for a selected save set.
drive	When dynamic drive sharing (DDS) is enabled, refers to the physical backup object, such as a tape drive, disk, or file. <i>See "device."</i>
DSA (Data Server Agent)	An agent save or agent recover between a NetWorker server and a non-NetWorker client. An example of a DSA is an NDMP host that generates proprietary save data and sends that data to a NetWorker storage device to have a save set associated to it.
DSA save set	Save sets of an NDMP client that are backed up to non-NDMP tape device.
DSP (Data Service Provider)	Controls access to disk storage during an NDMP back up.
DDS (Dynamic Drive Sharing)	A feature that allows NetWorker software to recognize shared drives.
E	
enabler code	A code that allow you to run NetWorker software.

enterprise	Computers and folders organized into a tree-based visual representation.
event	A notification of an application event. This notification contains information that may require user action.
exit code	An indicator that specifies whether a backup or recovery session succeeded. An exit code of zero (0) indicates the session completed successfully. An exit code other than zero indicates that the session did not complete successfully.
expiration date	The date when a volume changes from read/write to read-only.
expired save set	A save set that has reached its browse time and is no longer browsable.
F	
file index	See "client file index."
file system	<ol style="list-style-type: none"> 1. A file tree located on a specific disk partition or other mount point. 2. The entire set of all files. 3. A method of storing files.
firewall	A system designed to prevent unauthorized access to or from a private network.
folder	The graphical representation of a branching node in the Enterprise.
full backup	See "level."
G	
groom	To remove the original files from a disk after an archive.
group	A client or group of clients configured to back up files to the NetWorker server at a designated time of day.
GST (Generic Services Toolkit)	Provides the underlying framework of the Console server.
H	
heterogeneous networks	Computers of different platforms that interact across the network.
highly available system	A system that allows cluster-aware services to continue despite a hardware or software failure.
high-water mark	The percentage of disk space that when filled, automatically starts the staging process.
host authentication	A feature that provides encryption and verification services between NetWorker hosts. See also "user authentication."
host ID	A serial number that uniquely identifies a computer.

I

inactivity timeout The number of minutes to wait before a client is considered to be unavailable for backup.

incremental See "level."

individual user authentication The process by which Console administrators restrict or grant user access to NetWorker servers, based on Console usernames.

insertion time The time that the save set record was most recently introduced into the save set database.

Interactive mode A mode that displays reports (as charts or tables) that users can interact with. For example, one can sort, rearrange, and resize columns in a table-format report that was run in this mode.

J

JAR (Java Archive) A file that contains compressed components needed for a Java applet or application.

Java A high-level programming language. The Java Virtual machine (JVM) enables the same, unmodified, Java program to run on most computer operating systems. See "JVM (Java Virtual Machine)."

Java Plug-in A JVM that can be used by a web browser to run Java applets.

jukebox See "library."

JVM (Java Virtual Machine) An execution environment for interpreting the Java programming language. Each operating system runs a unique JVM to interpret Java code.

L

label A NetWorker assigned label that uniquely identifies a volume. Templates can be used to define label parameters.

LDAP (Lightweight Directory Access Protocol) A set of protocols for accessing information directories. LDAP is based on the X.500 standard, but is significantly simpler.

legacy method The use of special-case Microsoft APIs to back up and recover operating system components, services, and applications.

level A measurement that determines how much data is saved during a scheduled or ad hoc backup.

A full (f) backup backs up all files, regardless of whether they have changed. Levels one through nine [1-9] back up files that have changed since the last lower numbered backup level. An incremental (incr) backup backs up only files that have changed since the last backup.

library A mechanism that uses a robotic arm to move media among various components in a device. The term library is synonymous with autochanger, autoloader, carousel, datawheel, jukebox, and near-line storage.

library sharing	Shared access of servers and storage nodes to the tape drives in a library.
license enabler	A code that is required to run a feature or product.
LLM (License Manager)	An application that provides a central point for managing product licenses.
local cluster client	A NetWorker client that is not bound to a physical machine, but is instead managed by a cluster manager. It is also referred to as a logical or virtual client.
locale settings	Settings that specify the input and output formats for date and time, based on local language conventions.
logical cluster client	See "virtual cluster client."
logical device	A specific NetWorker device used in the integration of NetWorker software with SmartMedia or AlphaStor. SmartMedia or AlphaStor assigns the logical device to an actual device.
low-water mark	The percentage of disk space filled that, when reached, automatically stops the staging process.
LUS (EMC User SCSI)	A proprietary device driver that sends arbitrary SCSI commands to an autochanger.
M	
managed application	A program that can be monitored and/or administered from the Console server.
manual backup	A backup that a user performs from the client, also known as an unscheduled backup. The user specifies the files, file systems, and directories to back up.
media	The physical storage medium, such as magnetic tape, optical disk, or file system to which backup data is written.
media database	Indexed entries about the location and the life cycle status of all data and volumes that the NetWorker server manages. See "volume."
media index	See "media database."
member	A physical host in a cluster environment. Each member has its own IP address. A member can also be a virtual server .
metadata	VSS-defined information that is passed from the writer to the requestor. Metadata includes the writer name, a list of VSS components to back up, a list of components to exclude from the backup, and the methods to use for recovery. See "writer." See "requestor." See "VSS component."
mount	To make a volume physically available so that backup data can be written to it.
mount point	See "volume mount point."
multiplexing	To simultaneously write data from more than one save set to the same storage device.

N

NDMP (Network Data Management Protocol)	A TCP/IP-based protocol that specifies how heterogeneous network components communicate for the purposes of backup and recovery.
NDMP data server	An NDMP service that either reads from or writes to disk.
NDMP host	The host computer that executes the NDMP server application.
NDMP save set	A save set of an NDMP client that is backed up to an NDMP tape device.
NDMP server	An instance of one or more NDMP services controlled by a single NDMP control connection. Thus a data/tape/SCSI server is an NDMP server providing data, tape, and SCSI services.
NDMP service	The virtual state machine on an NDMP host that is controlled by the DMA. Examples of NDMP services include: <ul style="list-style-type: none"> ◆ A general server with direct attached storage (storage appliance) ◆ A system with one or more tape drives ◆ A software process that reads two datastreams and multiplexes them into one stream
NDMP storage node	A host having NDMP services or any open system having NDMP services installed. For instance, Netapp Filer and EMC Filer.
near-line storage	See "library."
NFS (Network File System)	A client/server application that allows users to access shared files stored on networked computers of different types.
NetWorker client	See "client."
NetWorker Console server	See "Console Server."
NetWorker Management Console	See "Console Server."
NetWorker server	The host running the NetWorker server software, which contains the online indexes and provides backup and recovery services to the clients on the same network. See also "online indexes."
NetWorker Administrator	A default NetWorker server user group that can add, change, or delete NetWorker server user groups.
NetWorker storage node	See "storage node."
NFS server	A computer that contains exported file systems that NFS clients can access.
node	See "member."
nonclone pool	Pools that contain data that has not been cloned.

non-NDMP device	A device that is not configured as an NDMP type of device.
notification	A message sent to the NetWorker administrator about important NetWorker events.
nsrd	The master NetWorker server process.
nsrhost	The logical hostname of the NetWorker server.
O	
online indexes	Databases on the NetWorker server that contain information about client backups and backup volumes. See "client file index." See "media database."
operator	The person who monitors the server status, loads backup volumes into storage devices, and executes day-to-day NetWorker tasks.
override	A backup level that takes place instead of the scheduled one.
P	
package	A term used by HP-UX to denote a cluster server. Also known as an agent (Sun) or virtual server (Microsoft).
packet filtering	A method of firewall protection that accepts or rejects packets entering or leaving the network based on user-defined rules. See "firewall."
parallelism	A method of backing up or recovering data from several clients or save sets in parallel.
pathname	Instructions for accessing a file. An absolute pathname indicates how to find a file starting from the root directory. A relative pathname indicates how to find the file starting from the current directory.
peer	A NetWorker host that is involved in an authentication process with another NetWorker host.
permanent enabler	A code that allows the software to be authorized for permanent use. See "temporary enabler." See "authorization code."
physical cluster client	A NetWorker client that is bound to a physical host in the cluster and can have its own resources (private or local).
physical host	A node or host that forms part of a cluster.
policy	A set of constraints that specify how long data is available for recovery. Each Client resource has a browse policy and a retention policy.
pool	A feature to sort backup data to selected volumes.
PowerSnap	EMC technology that provides point-in-time snapshots of data. NetWorker software backs up data from the snapshot. This allows applications to continue to write data during the backup operation, and ensures that open files are not omitted.
probe	A query to determine the directories or files to back up on each client.
purging	Deleting file entries from the client file index.

R

recover	To restore files from a backup volume to a client disk.
recyclable save set	A save set whose browse and retention policies have expired. Recyclable save sets are removed from the media database.
recyclable volume	A volume whose data has passed both its browse and retention policies and is now available to be relabeled.
Registry	A Microsoft Windows database that centralizes all Windows settings and provides security and control over system, security, and user account settings.
remote device	A storage device that is attached to a storage node.
RPC (Remote Procedure Call)	The protocol that the NetWorker server uses to perform client requests over a network.
repository	A Console database that contains configuration and reporting information.
requestor	A VSS-aware application that creates and destroys a shadow copy. NetWorker software is a requestor. See "shadow copy."
resource	A component that describes the NetWorker server or its clients. Clients, devices, schedules, groups, and policies are all NetWorker resources. Each resource has attributes that define its properties.
resource database	A database of information about each resource.
resource owner	A logical cluster host that owns the resource. If a Cluster resource, such as a shared disk, is not owned by a virtual host, it is assumed to be owned by the physical node that hosts the resource.
retention policy	Determines how long backup data is available for recovery, though not necessarily immediate recovery. See "browse policy."
retrieve	To locate and recover archived files and directories.
retry mechanism	The action NetWorker software performs when client operations fail. This situation might occur when the rate of transmission is either low or non-existent.
roles	Used to assign user privileges to the Console. There are three roles: Console Application Administrator, Console Security administrator, and the Console User. See also "user groups."
root	<ol style="list-style-type: none"> 1. (UNIX only) The UNIX superuser account. 2. (Microsoft Windows and UNIX) The highest level of the system directory structure.
S	
save	The command that backs up client files and makes entries in the online index.
save set	A group of files or a file system that is backed up on storage media.

save set consolidation	A process that performs a level 1 backup and merges it with the last full backup of a save set to create a new full backup. See "level."
SSID (Save Set ID)	An internal identification number assigned to a save set.
save set recover	To recover data by specifying save sets rather than by browsing and selecting files or directories.
save set status	An attribute that indicates whether a save set is browsable, recoverable, or recyclable. The save set status also indicates whether the save set was successfully backed up.
save stream	The data and save set information being written to a storage volume during a backup.
scanner	A command used to read a backup volume when the online indexes are no longer available.
server	See "NetWorker server." See "Console Server."
server index	See client file index .
service port	A port used to listen for backup and recover requests from clients through a firewall.
shadow copy	A temporary, point-in-time copy of a volume created using VSS technology. See "VSS (Volume Shadow Copy Service)."
shared disk	The storage disk that is shared among multiple nodes in a cluster.
shell prompt	A cue in a shell window where you enter a command.
silo	A repository for holding hundreds or thousands of volumes. Silo volumes are identified by bar codes, not by slot numbers.
skip	A backup in which designated files are not backed up. See "level."
snapshot	A point-in-time copy of data created during an instant backup.
snapshot policy	A NetWorker resource used to configure backups using the NetWorker PowerSnap Module software.
snapup	See "backup." Snapup is a term previously used by Avamar to refer to backup.
SNMP (Simple Network Management Protocol)	A protocol used to send messages to the administrator about NetWorker events.
staging	Moving data from one storage medium to a less-costly medium, and later removing the data from its original location.
stand-alone	In a cluster environment, a NetWorker server that starts in noncluster (stand-alone) mode.
stand-alone device	A storage device that contains a single drive for backing up data.
STL	Silo Tape Library.

storage device The hardware that reads and writes data during backup, recovery, or other NetWorker operations.

storage node A storage device physically attached to another computer whose backup operations are controlled by the NetWorker server.

T

tape service An NDMP DSP service that controls access to tape storage. A system can simultaneously host multiple tape services corresponding to multiple backup streams.

target sessions The number of backup sessions accepted by a backup device.

temporary enabler A code that allows operation of the software for an additional 45 days beyond the evaluation period. See ["enabler code"](#) and ["permanent enabler."](#)

TCP/IP (Transmission Control Protocol / Internet Protocol) A standard set of communication protocols that connects hosts on the Internet.

trap Unsolicited notification sent from the SNMP agent to the network manager's SNMP event manager.

U

update enabler A code that updates software from a previous release. Like other temporary enabler codes, it expires after 45 days.

- user**
1. A NetWorker user who can back up and recover files from a computer.
 2. A Console user who has standard access privileges to the Console server.

user authentication A feature that validates user sign-on attempts. NetWorker can validate sign-on attempts against either a central database, such as an LDAP database, or a local a Console database. See also ["host authentication."](#)

user alias The username seen by the NetWorker server when a Console user connects to the NetWorker server.

user groups Used to assign privileges to NetWorker users. See also ["roles."](#)

V

versions The date-stamped collection of available backups for any single file.

virtual cluster client A NetWorker client that is not permanently bound to a physical machine, but is instead managed by a cluster manager. It can be bound to more than one physical machine in the cluster and can own its own data disks. It is also referred to as a logical cluster client or a virtual client.

virtual server A Microsoft term to denote a cluster server. Also known as an agent (Sun) or a package (HP-UX).

- volume**
1. The physical storage medium, such as magnetic tape, optical disk, or file system to which backup data is written.

2. An identifiable unit of data storage that may reside on one or more computer disks.

volume ID	An internal identification that NetWorker software assigns to a backup volume.
volume mount point	A disk volume that is grafted into the namespace of a host disk volume. This allows multiple disk volumes to be linked into a single directory tree, and a single disk or partition to be linked to more than one directory tree.
volume name	The name assigned to a backup volume when it is labeled. See "label."
volume pool	See "pool."
VSS (Volume Shadow Copy Service)	Microsoft technology that creates a point-in-time snapshot of a disk volume. NetWorker software backs up data from the snapshot. This allows applications to continue to write data during the backup operation, and ensures that open files are not omitted
VSS component	A subordinate unit of a writer. See "writer."

W

writer	A database, system service, or application code that works with VSS to provide metadata about what to back up and how to handle VSS components and applications during backup and restore. See "metadata" and "VSS component."
---------------	--

A

- aborting a recover 674
- ACPI
 - NetWorker support 742
 - OnNow 742
 - recover considerations 743
 - scheduled backup considerations 743
- actions, notifications 450
- Active Directory
 - backup 736
 - domain controller 736
 - explained 736
 - recover 736
 - prerequisites 346
 - SYSTEM STATE save set 710, 736
- adding
 - annotation 391
 - enabler code 423
 - folder 429
 - host 428
 - license 423
 - multiple hosts 431
- addresses
 - server, changing 697
- Administration window 38
- administration window
 - opening 40
- administrator
 - adding 441
 - privileges 433, 440
 - Windows groups and NetWorker privileges 442
- administrators
 - group 45
- Advanced Configuration and Power Interface. See ACPI
- Advanced File Type Device
 - concurrent access 260
 - concurrent operations 250
 - notification 252
 - retention policy 252
 - simultaneous recovery of save sets 260
- aes encrypted data
 - implementing 77
 - recovering 328
- AFTD load balancing 253
- AIX
 - EMC AutoStart, using with 494, 497
- alert priority 390, 398, 401
- alerts
 - lists priority, category, time, and message 394
- Alias attribute 689
- aliases, host sharing restriction 672
- AlphaStor
 - firewall issues 724
- annotation
 - adding 391
 - attribute 390
 - icon 391
 - viewing 391
- ansrd service 49
- application data
 - recovering on NetWorker client
 - UNIX 760
- application information field
 - Auspex 567
 - EMC 564, 565
 - NetApp 561
- application specific module (ASM) 178
- archive
 - changing time of 211
 - request, starting automatically later 403
 - stopping request in progress 403
- Archive attribute 151
- Archive button 45
- archiving
 - archive pools
 - errors 699
 - archive requests
 - creating 210
 - defined 209
 - deleting 211
 - disabling 215
 - editing 211
 - archive services
 - enabling 208
 - archive volume pool 204
 - compared to backups 204
 - copying an archive request 211

- disable scheduled archive 403
 - enabling 206, 207
 - grooming files 204
 - indexed 206
 - licensing 204
 - managing 215
 - manual 208
 - naming archive requests, errors 699
 - NDMP 526
 - NetWorker User program
 - toolbar function 45
 - nonindexed 206
 - nsrarchive program considerations 699
 - permissions 206
 - permissions
 - Archive feature 207
 - pools
 - configuration 190
 - creating 196
 - types of pools 207
 - remote requests, failure 698
 - requesting an archive 402
 - requesting an archive's status 394
 - requirements 204
 - retrieving from client machine 212
 - save sets 204
 - multiple 699
 - retrieving 212, 213
 - scheduled 209
 - scheduling 215
 - starting 215
 - stopping 215
 - time change 211
 - tracking entries 205
 - troubleshooting 698
 - viewing details 215
 - volumes, cloning 229
 - ASM (application specific module) 178
 - ASR save set 586, 713
 - ASR. See Automated System Recovery
 - attribute
 - Administrator 441
 - annotation 390
 - auth code 423
 - category 389
 - enabler code 423
 - Grooming
 - limitation 210
 - message 390
 - note 390
 - priority of managed event 389
 - See also specific attribute name
 - server name 389
 - time 389
 - auth code attribute 423
 - authentication
 - considerations for 476
 - login 406
 - nsrauth 476
 - oldauth 476
 - authorization code
 - error message 701
 - Auto Media Management
 - recyclable volumes 161
 - auto media verification
 - media position errors 669
 - Autochanger parallelism 438
 - autochangers
 - AIX considerations 754
 - attributes
 - new 679
 - Auspex support 566
 - autodetection 680
 - control ports access 682
 - destination component 680
 - EMC Celerra support 563
 - EMC IP4700 support 564
 - HP-UX considerations 752
 - installation, HP-UX considerations 749
 - maintenance commands 680
 - NDMP support 530, 531
 - NetApp support 560
 - sharing
 - NDMP clients 533
 - sharing with NDMP support 533
 - STK-9840 754
 - Automated System Recovery
 - 2008, 2008 R2, Windows 7 597
 - ASR save set 586, 713
 - cluster database, special handling 594
 - COM+ database, special handling 594
 - disk quota database, special handling 594
 - documentation 586
 - FAT16 partitions 588
 - NetWorker software support 586
 - OEM recovery CD 588
 - overview 586
 - recovering a client 592
 - scheduled backup of ASR save set 589, 590, 591, 616
 - Sun StorageTek EBS software support 586
 - usage overview 587
 - verifying client recovery 595
 - WMI database, special handling 594
 - Autorestart attribute 133, 495
 - Autostart attribute 133
- B**
- back ups, manual 80
 - backing up Console 79
 - backing up renamed directories 60, 96
 - Backup button 45
 - backup configuration wizard 55
 - backup groups. See groups
 - backup levels
 - 1-9 147
 - described 147
 - options 147
 - overriding 145
 - planning 147, 149
 - types

- consolidated 142, 147, 149, 150, 153
 - full 147, 149, 150, 672
 - incremental 147
 - level 150
 - skip 147
 - usage 149, 150
 - backup schedules. *See* schedules
 - backups
 - Backup and Recover Server service 446
 - balancing resources 130, 143
 - bootstrap 138
 - client-initiated 189
 - commands 86
 - example 88
 - savepnpc program 91
 - completed 138
 - consolidated 142
 - customization scripts 87
 - cycle, using levels 141
 - data in a cluster environment 492
 - database in a cluster environment 494
 - directives 170
 - failed 85
 - filesystems 143
 - force incremental 136
 - groups. *See* groups
 - hard links 85
 - incremental
 - pool for 189
 - large client filesystems 485
 - large filesystems 144
 - levels 149, 156
 - log file 85
 - managing 137
 - manual 54, 65
 - policies 167
 - pool for 189
 - NDMP 525
 - consideration with Auspex 565
 - NetWorker cluster clients 493
 - NetWorker User program
 - browse windows 45
 - nonscheduled 54, 65
 - nsrndmp_save command, using 539, 540
 - online indexes 150
 - operations
 - stopping 668
 - operators group 45, 446
 - permissions, backup operators group 446
 - pools 184
 - previewing 137
 - recoveries 667
 - RPC errors 674
 - save sets. *See* save sets
 - server, forced 676
 - time intervals, setting 135
 - troubleshooting 667
 - types of backups. *See* backup levels
 - virtual server 493
 - Windows NT registry 67
 - bar chart 364
 - basic reports 356
 - best practices for cloud backups 121
 - BlueArc
 - requirements 568
 - BMR support
 - configuring a client 474, 657
 - establishing the HomeBase Server 436
 - recovery process 328, 658
 - specifying profile options 474, 657
 - bootstrap
 - emailing 138
 - NDMP limitation 525
 - pools 186
 - printing 138
 - failure 676
 - boot-time file 695
 - browse policies
 - about 157, 158
 - client file index growth 455
 - clones, storage nodes 231
 - defined 158
 - save set recoveries 338, 339
 - usage 158
 - browse windows
 - described 45
 - toolbar 45
 - browser
 - unresponsive 701
- ## C
- capture of managed event 389
 - case sensitivity 382, 419
 - category attribute of managed event 389
 - centralized
 - license management 37
 - Certificate Server
 - recovery prerequisites 346
 - SYSTEM STATE save set 710
 - certified protocols 696
 - changing
 - name of folder 430
 - password 412
 - changing password, user 412
 - changing servers 46
 - characters
 - illegal 429, 431
 - characters, not permitted 408, 429, 431
 - chart formats 361
 - checkpoint restart backups 69
 - CHKDSK, running 65
 - client 470
 - client alias, changing 671
 - client backup configuration wizard 55
 - client file index
 - backup level, pool for 189
 - browse policies 158, 459
 - checking 673
 - clones and storage nodes 231
 - cross-checking 457

- defined 454
- entries
 - adding 455
 - removing 455, 459, 461
- growth 455
- location, designating 458
- managing size 459
- operations
 - backups 150
 - checking 455
 - moving 459
 - recovery 316, 337
- policies 459
- pools 186
- restoration 338
- save sets
 - cycles, removing 460
 - entries 161
 - removing 459
- size 454
 - management 459
 - notification 673
- Client parallelism 437
- Client Retries attribute 133
- client-initiated backups
 - pool for 189
- clients
 - aliases, problems 671
 - backup commands 86
 - backups
 - ad-hoc 49
 - scheduled 49
 - client ID
 - creating new client 340
 - client/server communication errors 691
 - cloning
 - examples 225
 - cluster, backup 493
 - configuration 470
 - defined 470
 - DHCP 446
 - DNS name resolution 446
 - editing 470
 - groups 130
 - large filesystems 144
 - manual backups 54
 - multiple 485
 - NetWorker
 - definition of 470
 - NetWorker User program 44
 - of NetWorker server 79
 - operations
 - archive retrieve 212
 - backing up renamed clients 673
 - backups 485
 - creating 470
 - editing 470, 471, 477, 478, 481
 - indexes, moving 459
 - installation 470
 - manual backups 54
 - recovery, failure 673
 - policies, multiple 164
 - priority 487
 - programs 49
 - save sets 485
 - services 49
 - Solaris binary location 746
- clone pools, configuring 190
- Clone reports 355, 370, 371
- Clone Volumes dialog box 227
- cloning
 - archives 229
 - defined 218
 - destination volume, defined 218
 - examples 225
 - manual 223
 - online indexes, storage nodes 231
 - recovery
 - save sets 228
 - volumes 227
 - save sets 219, 223
 - manually 225
 - performing 223
 - source volume, defined 218
 - storage nodes
 - online indexes 231
 - volumes 227
 - creating 227
 - details, viewing 227
 - process 227
- cloning to cloud 125
- cloud
 - best practices 121
 - cloning 125
 - compared to other device types 120
 - data consumption information 124
 - prerequisites 120
 - reports 379
 - setting up a cloud device 122
 - staging 125
 - support for 120
- cluster
 - performance issues 516
- Cluster Server
 - recovery prerequisites 346
 - SYSTEM STATE save set 710
- clusters
 - backups 494, 496
 - client 493
 - data 492
 - database 494
 - clients 495
 - data corruption 508
 - devices 507
 - jbconfig program considerations 509
 - MC/ServiceGuard 496
 - recovery types 502
 - storage node 506
 - tape libraries 507
 - virtual client backing up to a local storage node 497

- virtual server backup 493
 - COM+ Database
 - recovery prerequisites 346
 - SYSTEM STATE save set 710
 - command
 - export 420
 - gst 51
 - savepsm 79
 - command line
 - reporting 357, 385, 386
 - reporting program 385
 - Common Device Interface
 - SCSI command 269
 - Completion Data Retention 353
 - completion data retention 353
 - completion message retention 353
 - compression, data 78
 - computer damage, recovery from 413
 - configuration
 - IP issues 696
 - configuring
 - Host reports 378
 - NetWorker Backup Statistics reports 367, 373, 375
 - reports 358
 - connection
 - problem 701
 - refused 701
 - connections, server
 - problem resolution 696
 - Console
 - environment variables 415
 - Console client
 - starting, after the first time 40
 - Console Configuration Wizard 420
 - console security administrator
 - resetting administrator password 412
 - Console software
 - as NetWorker client 79
 - improving performance 415
 - License Manager 424
 - load on CPU 416
 - logging on 39
 - managing window 36
 - URL 39
 - user roles in 406
 - Console window
 - opening 39
 - console window 37
 - consolidated backups 149, 153
 - consolidating save sets
 - nsrsc command 155
 - contacting server, problem with 701
 - Content Index Server
 - backing up 82, 83
 - backup 83
 - defined 82
 - recover 82, 348
 - SYSTEM DB save set 82, 348, 712
 - control zone 426
 - copying host 429
 - corrupted database 701
 - CPU load 416
 - creating
 - folder 429
 - host 428
 - label templates 200
 - pools 191
 - staging policies 236
 - criteria for organizing hosts 426
 - critical priority 390, 398, 401
 - cross-checking online indexes 457
 - cross-platform
 - name resolution 446
 - CSV 384
 - cutting and pasting host 429
- D**
- daemon log file 463
 - daemon.log 464
 - damaged computer 413
 - data
 - backing up in a cluster environment 492
 - compression 78
 - encryption with aes ASM 77
 - life cycle
 - cloned data 226
 - managing 162
 - recovery, name conflicts 322
 - relocating, errors 674
 - sorting
 - into pools 185, 187, 188
 - to storage devices 190
 - verify 69
 - data compression 681
 - Data Domain deduplication 30
 - Data Retention dialog box 354
 - database
 - backing up 79
 - corrupted 701
 - corruption 701
 - delete failed 702
 - failed to store 702
 - fetch operation 701
 - database backup in a cluster environment 494
 - database, fetch operation failure 701
 - db-output 703
 - dbsrvr9 704
 - dbstop output 703
 - DDS (dynamic drive sharing)
 - clustering 511
 - robotics control 513
 - debug level 416, 419
 - debug messages
 - logging stopped 703
 - deduplication
 - Data Domain 30
 - default backup schedules 141
 - default pool 184, 188, 189
 - definition of
 - NetWorker client 470

- delete operation failed 702
 - deleting
 - folder 429
 - host 428
 - label templates 201
 - license 423
 - managed event note 391
 - multiple hosts 431
 - note 391
 - problem 702
 - staging policies 239
 - user 411
 - device 244
 - lists of 394
 - related messages 394
 - Device configuration wizard 247
 - devices
 - device drivers
 - maintenance commands 680
 - device ordering 269
 - correcting device order problems 271
 - detecting device order problems 270
 - disk label errors 675
 - filesystem
 - staging 236
 - labeling errors 675
 - load balancing 253
 - nonrewinding 683
 - pools 190
 - DFS (Distributed File System)
 - junctions 730
 - not in SYSTEM save sets 712
 - recover 732
 - DHCP (Dynamic Host Configuration Protocol)
 - database 83, 348
 - static IP address for NetWorker server 697
 - DHCP (dynamic host configuration protocol) 692
 - clients 446
 - dialog box
 - Data Retention 354
 - DinoStor TapeServer
 - configuration 569
 - directed recoveries 336
 - directed recovery
 - access 331
 - advantages 330
 - defined 329
 - NDMP 549
 - performing 325, 326, 336
 - recover program 334, 335
 - UNIX clients 336
 - use of 330
 - directives
 - ASM (application specific modules) 178
 - copying 171
 - creating 170
 - defined 170
 - deleting 171
 - editing 171
 - naming restrictions 670
 - preconfigured 174
 - disabling
 - managed event capture 389
 - disabling user datagram protocol 417
 - disallowed characters 408, 429, 431
 - disappearing managed event 392, 703
 - disaster recovery 329
 - Windows 2003, XP 585
 - Windows 2008, 2008 R2, Windows 7 597
 - disk quota database
 - recovery prerequisites 346
 - SYSTEM DB save set 712
 - disk space
 - insufficient 701
 - disk space, gstd log file 416, 419, 704
 - disk space, gstd.log 419
 - display problem 702
 - displaying
 - annotation 391
 - reports 360
 - DNS
 - hostname alias, troubleshooting 671
 - DNS (Domain Name System) 692
 - host name determination 446
 - document view 366
 - domain controller
 - Active Directory, configured by 736
 - defined 736
 - encryption keys
 - not supported 737
 - drag-and-drop, column 40
 - drill-down reports, Managed Event 377
 - DSA 520
 - DSA and NDMP Tape Server distinctions 522
 - duplicating host 429
 - dynamic addressing 446
 - dynamic host configuration protocol (DHCP) 692
- ## E
- ECB (Event Control Block) 669
 - editing
 - clients 470
 - folder 430
 - label templates 201
 - pools 195
 - staging policies 238
 - user 412
 - emailing the bootstrap report 138
 - EMC AutoStart 494, 497
 - EMC, application information values 564
 - emergency priority 390, 398, 401
 - enabler code 423
 - enabler code, entering 423
 - enabler code, problem 702
 - enabling
 - debug information 416, 419
 - JavaScript 705
 - software 423
 - encrypting data
 - aes 77

- Encrypting File System
 - backup 736
 - directed recover 736
 - encryption keys 737
 - explained 736
 - not in SYSTEM save sets 712
 - recover 736
 - entering
 - enabler code 423
 - license 423
 - enterprise
 - button 37
 - enterprise hierarchy
 - adding folder 429
 - adding host 428
 - copying folder 430
 - copying host 429
 - deleting folder 429
 - deleting host 428
 - folder 426
 - host 426
 - managing host 428
 - managing multiple hosts 431
 - moving folder 430
 - moving host 429
 - renaming folder 430
 - viewing 427
 - Enterprise Summary report 378
 - environment variable 419
 - GST_DEBUG 704
 - GST_MAXLOGSIZE 419, 704
 - GST_MAXLOGVERS 419, 704
 - setting 419
 - environment variables
 - format 464
 - NSR_DEV_BLOCK_SIZE_MEDIA_TYPE 262, 267
 - NSR_DEV_LOAD_POLL_INTERVAL_MEDIA_TYPE 268
 - NSR_DEV_LOAD_TIME_MEDIA_TYPE 268
 - NSR_DEV_LOAD_TRY_TIMEOUT_MEDIA_TYPE 268
 - NSR_DEV_TAPE_FILE_SIZE_MEDIA_TYPE 267
 - NSR_DEV-DEFAULT_CAPACITY_MEDIA_TYPE 268
 - error
 - database store 702
 - relocating data 674
 - RPC (remote procedure call) 674
 - error messages 701
 - copy violation 676
 - destination component 680
 - disk label 675
 - environmental variables 700
 - hardware address not found 751
 - illegal record size 670
 - media verification 669
 - no space left in tape 756
 - nwrecover program 672
 - print server 451
 - RPC errors 694
 - save sets 672
 - server, unavailable 694
 - xview 676
 - Event Control Block (ECB) 669
 - event logs
 - backup 738
 - explained 738
 - not in SYSTEM save sets 712
 - recover 738
 - Event Time 377
 - Event Viewer 452
 - example
 - organizing hosts 426
 - sorting managed event 40
 - export command 420
 - export formats 384
 - exporting
 - non-ASCII characters 384
 - reports 384
 - external authentication to LDAP server 406
- F**
- failed
 - operation 702
 - failed operation 701
 - failover, save group requirements 495
 - FAT16 partitions, ASR limitation 588
 - fetch operation 701
 - Figure 105
 - file conversion, sparse to fully-allocated 677
 - file handling
 - indicators 46
 - file index missing, message 673
 - File Manager 672
 - File Replication Service
 - backup 738
 - SYSTEM STATE save set 710
 - filemarks 681
 - filename, support for short names 84
 - files
 - compressing 78
 - encrypting 77
 - HOSTS 446
 - log 703
 - naming conflicts on recovery 322
 - open files, backing up 139
 - relocating during recovery 323
 - servers 487, 689
 - verify 69
 - filesystem devices 236
 - filesystems
 - backups, large 485
 - firmware, verification 685
 - folder 426
 - adding 429
 - deleting 429
 - editing 430
 - Force Incremental attribute 144
 - force incremental attribute 136
 - formats

export 384
full backups 149

G

grooming 210
 limitation 210
grooming files 204
group
 backup, stopping 396
 restarting backup 396
 start immediately 395
 viewing control details 396, 400
 viewing status 394
Group resource
groups 130
 attributes 133
 backup operators 446
 backups
 management 137
 previewing 137
 bootstrap 138
 client policies, multiple 164
 completed 138
 containing bootstrap 670
 defined 130
 filesystems, large 143
 force incremental, setting 136
 listing of per server 394
 naming restrictions 670
 NetWorker User program privileges 44
 operations
 copying 135
 deleting 135
 editing 134
 previewing 137
 time intervals, setting 135
 types 133
gst command 51
GST server process 704
GST_DEBUG 704
GST_MAXLOGSIZE 419, 704
GST_MAXLOGVERS 419, 704
gstd 704
 environment variable 419
 log 416, 419, 704
 process 51
 size of log 416, 419, 704
gstd log file 704
gstd service 50
gstdmodconf command 431, 432

H

hard links, backup and recovery 85
hardware
 upgrade 413
HomeBase Server 657
host
 adding 428
 copying 429

deleting 428
 managing 428
 moving 429
 organization of 426
 transfer affidavit 415

Host List 378
host name determination
 DHCP clients 446
 TCP/IP 446
Host Reports 355
 types and their configuration 378
hostname alias 671
hostname file 431
HOSTS file 446
hosts table, setting up 691
How 358
HP MC/ServiceGuard
 clusters 496
HP Tru64 See Tru64. 754
HP-UX
 creating device files 750
 EMC AutoStart, using with 494, 497
 installing autochangers 749
 pass-through drivers 749
HTML 384
HTTP service port 39
hung browser 701

I

icon
 annotation 391
 priority 390
IIS (Internet Information Server)
 defined 738
 recovery prerequisites 346
 SYSTEM STATE save set 710
Importing save set information to a different server 340
Inactivity Timeout attribute 133
incremental backup
 NDMP limitation 544
incremental backups
 pool for 189
Index Save Sets dialog box 456
indexed archives 206
individual user authentication 417
info priority 390, 398, 401
information, sorting table 40
inquire program 531, 748
install log 703
Interactive view 360
interface
 overview 36
Internet Information Server See IIS
Interval attribute 133
Invalid Object id, error message 702
ioscan program 749
IP
 errors
 hosts table 691
 troubleshooting 691

name search order, setting 692
 IP configuration, issues 696
 IPAT (IP address takeover) 495

J

Java Runtime Environment 386
 JavaScript 705
 jbcconfig program
 autochangers
 HP-UX 752
 clusters 509
 hanging 680
 jbxercise program
 NDMP, not supported 526
 jobsd service 50
 JRE 39, 385, 386
 Jukebox parallelism 438

L

label templates
 attributes 199
 components 200
 creating 200
 deleting 201
 editing 201
 naming restrictions 670
 naming strategies 199
 number sequences 199
 preconfigured 197
 labeling
 tips 200
 labels
 silos, volumes 197
 launch button 39
 lomap, improving performance of 516
 LDAP login authentication 406
 level of debug 416, 419
 Library parallelism 438
 license
 adding 423
 deleting 423
 License allocation failed, error 702
 License Manager 424
 licensing
 archiving 204
 copy violation 676
 License Manager 424
 Linux, EMC AutoStart, using with 494, 497
 list command 563
 List Report, User 378
 LMHOSTS 446
 load balancing 253
 local backups with NDMP
 introduction 521
 localized environments 359
 location of
 gst command 51
 lockbox for pass phrases 475
 log file 419, 703, 704

log files
 backup/recovery attempts 85
 cloning information 218
 management 463
 viewing 663
 logging on
 to Console software 39
 logging, events 452
 login
 authentication 406
 name 408
 password 408
 lsdev program 750

M

Mac OS X 758
 managed application 426
 managed event
 define 388
 deleting note 391
 disabling capture of 389
 disappearing 392, 703
 polling 416
 priority 390
 response time
 modifying 416
 sorting example 40
 Managed Event configuration
 parameters 377
 Managed Event drill-down reports 377
 Managed Event Reports 355
 Managed Events button 37, 38
 managed node 426
 adding 428
 copying 429
 deleting 428
 moving 429
 managing
 host 428
 license 424
 manual backups 80
 manual backups. See backups, manual 54
 Manual Restart option 495
 Many 718
 Max active devices 438
 Max parallelism, media libraries 438
 Max parallelism, pools 440
 Max sessions 440
 MC/ServiceGuard
 clusters 496
 media database
 backups 150
 cloned data 226
 clones and storage nodes 231
 compression 460, 462
 cross-checking 457
 entries, removing 461
 managing size 454, 460
 restoration 339
 retention policies 158

- save sets, entries 161
 - Media Library parallelism 438
 - media pools. See pools
 - media position errors 669
 - memory
 - NDMP requirements 526
 - message attribute of managed event 390
 - message logs
 - failed backup/recovery attempts 85
 - management 463
 - reducing size 463, 464
 - message retention 353
 - messages file
 - Event Viewer 452
 - Microsoft Automated System Recovery. See Automated System Recovery
 - Microsoft Windows
 - backup operators group 446
 - Event Viewer 452
 - Windows 2000
 - databases
 - not in SYSTEM save sets 712
 - SYSTEM DB save set 712
 - Windows Management Instrumentation
 - SYSTEM DB save set 712
 - Mirapoint
 - requirements 568
 - mminfo program
 - reports 168
 - modifying
 - log size 419
 - response time 416
 - user 412
 - modules
 - NDMP 538
 - moving host 429
 - multiple hosts
 - adding or deleting 431
 - Multiplexing 439
 - multiplexing
 - performance issues 32
- N**
- name
 - conflicts on recover 322
 - folder, editing of 430
 - resolution cross-platform 446
 - servers, issues 697
 - name resolution 692
 - name servers, disabling 692
 - naming restrictions 670
 - native login authentication 406
 - NDMP (Network Data Management Protocol) 520
 - application information variables 537
 - archives 526
 - Auspex
 - autochanger handle 566
 - autochangers
 - configuration 531
 - list command 563
 - sysconfig program 560
 - backups
 - command line options 539, 540
 - parallel 525
 - bootstrap limitation 525
 - changing location of temporary space directory 527
 - clients
 - definitions 525
 - configuration
 - NetWorker server 529
 - options 520
 - Sun StorageTek EBS server 529
 - device pathname 530
 - directed recoveries 549
 - EMC Celerra
 - autochanger handle 563
 - EMC IP4700
 - autochanger handle 564
 - Force Incremental setting 545
 - incremental backup limitation 544
 - inquire program 531
 - memory requirements 526
 - NetApp
 - autochanger handle 560
 - NetWorker
 - changes with NDMP 526
 - index database 527
 - index processing and memory requirements 526
 - nsr resource attributes 526
 - operations
 - browsing 526
 - recoveries 545
 - recoveries, directory level 546, 547
 - prerequisites 538
 - protocol limitations 526
 - save set operations
 - consolidation 526
 - recovery 526
 - savegroup Parallelism setting 538
 - scanner program 526
 - sharing autochangers 533
 - silos support 534
 - storage node support for NDMP client backup 542
 - storage node support for NDMP clients 528
 - temp storage space requirements 527
- Nested Mountpoints 347
 - network
 - DNS connection issues 696
 - IP configuration issues 696
 - TCP/IP certified 696
 - NetWorker 447
 - clustering
 - clients
 - backup 493
 - interfaces 47
 - NDMP
 - effects on 526
 - server
 - organization of 426
 - startup commands 667

- User program. See NetWorker User program
 - virtual server backup 493
 - NetWorker Backup Statistics drill-down reports 368, 373
 - NetWorker Backup Statistics Reports 355
 - NetWorker Backup Statistics reports
 - types and their configuration 367, 373, 375
 - NetWorker Backup Status drill-down report 370
 - NetWorker Backup Status Reports 355
 - NetWorker Backup Status reports 368
 - NetWorker client
 - definition of 470
 - NetWorker DiskBackup
 - advanced file type concurrent operations 250
 - file type and advanced file type differences 244
 - notification 252
 - retention policy 252
 - NetWorker Management Console See Console
 - NetWorker server
 - organizing 426
 - NetWorker User program
 - backing up registry, Windows NT 67
 - browse windows 45
 - changing servers 46
 - compression 78
 - connecting to a server 46
 - encryption 78
 - manual backups 65
 - overview 44
 - password protection 78
 - privileges 44
 - server connection 46
 - starting 44
 - toolbar 45
 - NMC See Console
 - node
 - adding 428
 - copying 429
 - deleting 428
 - managed 426
 - moving 429
 - nonindexed
 - archives 206
 - note
 - attribute 390
 - deleting from managed event 391
 - notifications 453
 - defined 447
 - deleting 454
 - operations
 - customizing 449
 - preconfigured 447
 - printing 450
 - priorities 451
 - programs 450
 - SNMP
 - configuring 574
 - creating 575
 - modifying 575
 - nsrtrap 574
 - nsr_getdate program 167, 168
 - nsr_render_log 663
 - nsr_shutdown program 464, 669
 - nsradmin program
 - editing the nsrla.res database 472
 - starting 48
 - nsrarchive program 205
 - nsrauth authentication 476
 - nsrck program 337
 - nsrd daemon 464
 - nsrd service 49, 464
 - nsrexecd 51
 - nsrexecd daemon 464
 - nsrexecd service 49, 464
 - nsrindexd service 49
 - nsrjb program
 - troubleshooting, HP-UX 752
 - nsrla.res database 472
 - nsrlpr program 450
 - nsrmm program 168, 339, 459, 670
 - nsrmmmd daemon 268
 - NDMP
 - unsupported options 526
 - nsrmmmd service
 - NDMP
 - unsupported options 526
 - nsrmmdbd service 49
 - nsrmmgd service 49
 - nsrndmp_recover program 545, 546, 547
 - nsrndmp_save program 542
 - backing up data 539, 540
 - nsrssc program 155
 - nsrtrap 574
 - command line options 528, 574
 - verbose mode 575
 - numeric order 40
 - nwrecover program 47, 214
 - browse policy 158
- ## O
- object, reference 702
 - OEM recovery CD, ASR limitation 588
 - offline disaster recovery, Windows 597
 - oldauth authentication 476
 - online indexes
 - cross-checking 457
 - entries
 - checking 455, 673
 - removing 455, 461
 - information
 - refreshing 457
 - viewing 455
 - management
 - manual 454
 - size 459
 - moving 459
 - recovery
 - location 670
 - restoration 338
 - save sets, viewing 456
 - size considerations 455

- volumes
 - removing 461
 - OnNow
 - Advanced Configuration and Power Interface (ACPI) 742
 - recover considerations 743
 - scheduled backup considerations 743
 - open files, backing up with VSS 140
 - operation failed 701, 702
 - optimizing Console 415
 - organizational criteria 426
 - organizational structure, labeling for 200
 - organizing
 - NetWorker Servers
 - example 426
 - out of memory 701
- P**
- page cannot be displayed 702
 - Parallelism 437
 - parallelism
 - performance 32
 - password
 - changing 412
 - pathname restrictions 672
 - Path-to-Tape support 555
 - PDF report format 384
 - performance
 - features 32
 - Performance Counters
 - SYSTEM STATE save set 710
 - performance of Console software 415
 - permissions
 - Archive feature 206
 - backup operators group 446
 - Persistent binding 270
 - Persistent naming 270
 - pie chart 364
 - pie report format 364
 - plot chart 364
 - policies 165
 - backups, manual 167
 - browse
 - about 157, 158
 - data life cycle 162
 - defined 158
 - modifying 168
 - usage 158
 - clients 164
 - data life cycle 162
 - multiple 164
 - naming restrictions 670
 - overriding 167
 - planning 143
 - retention 160
 - about 157, 158
 - data life cycle 162
 - defined 158
 - modifying 168
 - usage 158
 - volume relabeling 158
 - setting expiration 354
 - policy
 - deleting 165
 - polling 416
 - pool
 - configuration 615
 - consolidated backup 187
 - copying resource 196
 - Pool parallelism 440
 - Pool Type attribute, with archive pools 207
 - pools
 - archive 190
 - errors 699
 - archives, creating 196
 - archiving 196
 - bootstrap 186
 - client file index 186
 - clones 190
 - configuration
 - archive 190
 - clone 190
 - creating 191
 - criteria 185, 187
 - data sorting 185, 188
 - default 184, 188, 189
 - clone pool 190
 - defined 184
 - devices 190
 - editing 195
 - expression matching 186
 - incremental backups 189
 - manual backups 189
 - precedence 187
 - restrictions 185
 - save set consolidation 155
 - sorting data 190
 - volume labels 197
 - port
 - HTTP service 39
 - port range
 - troubleshooting 698
 - portmappers
 - verifying 693
 - POSIX hard links, problems recovering 85
 - PostScript report format 384
 - Power Monitor service 742
 - precedence for pools 187
 - preconfigured notifications 453
 - priorities, notifications 451
 - priority
 - of managed event 390
 - symbol 390, 398, 401
 - Priority attribute 389
 - privileges
 - administrator 433
 - probe based backups 69
 - problem
 - contacting server 701
 - process, stopping and restarting 51

- processor load 416
 - Procom NetFORCE
 - requirements 567
 - Program not registered 702
 - program not registered 702
 - programming thread 416
 - properties
 - user 412
 - Properties dialog box
 - NetWorker User program 46
 - protocols, certified 696
 - provider 647
 - ps command 705
- R**
- rearranging enterprise hierarchy 429
 - rearranging information in table 40
 - Recover button 45
 - recover program
 - clusters, using with 503
 - media database 161
 - options 334, 335
 - retention policy 160
 - recoveries 317
 - archives 212
 - Backup and Recover Server services 446
 - backup operators group 446
 - client file index 337
 - clients, renamed 673
 - clone volumes 227
 - cluster 502
 - conflict resolution 322
 - conflicts 321
 - directed 336
 - access 331
 - advantages 330
 - defined 329
 - recover program 334, 335
 - usage 330
 - disaster-related 329
 - failed 85
 - failure 672
 - files, finding for recovery 324
 - hard links created by POSIX 85
 - index-based
 - advantages 316
 - interrupted backups, from 672
 - log file 85
 - methods, comparing 316
 - NDMP 545, 546, 547
 - NetWorker User program
 - browse windows 45
 - planning 143
 - relocation 323
 - save set recovery 325
 - save sets
 - client file index 338
 - media database 339
 - type, determination 316
 - volumes
 - required 324
 - recovery
 - aborting 674
 - ASR 592
 - recycling. See volumes
 - reference object 702
 - refused connection 701
 - registering program 702
 - registry
 - backups 739
 - backward compatibility 739
 - explained 739
 - REGISTRY save set 739
 - SYSTEM STATE save set 710, 739
 - relocating data 674
 - remote access
 - recoveries 689
 - Remote Access list 689
 - remote archives, failure 698
 - remote backups with NDMP TapeServer software
 - performing 571
 - Remote NDMP backups with DinoStor TapeServer
 - performing 570
 - remote NDMP backups with SnapImage software
 - performing 571
 - Removable Storage Manager
 - recovery prerequisites 346
 - SYSTEM DB save set 712
 - removing
 - folder 429
 - host 428
 - license 423
 - user 411
 - renamed directories, backing up 60, 96
 - renaming folder 430
 - report
 - background processing 366
 - chart types 363
 - document mode 362
 - export formats 384
 - interactive mode 360
 - restricted views 366
 - User List 378
 - reports
 - basic and drill-down 356
 - command line reporting program 385
 - customized 357
 - daemon log file 463
 - daemon.log 464
 - date and time formats 358
 - Managed Event Drill-Down 377
 - message logs
 - management 463
 - reducing size 463
 - save set policies 168
 - saved 381
 - viewing 360
 - Reports button 37, 39
 - requirements
 - NetWorker User groups 44

- resetting administrator password 412
 - resolved events 391
 - resource
 - archive
 - changing archive time 211
 - request
 - copying 211
 - status 394
 - label template
 - copying 201
 - notification
 - copying 453
 - deleting 454
 - policy
 - deleting 165
 - pool
 - copying 196
 - directing data from consolidated backup 187
 - staging
 - copying a policy 238
 - user group
 - copying 445
 - creating 444
 - customizing privileges 443
 - deleting 445
 - editing 445
 - preconfigured 442
 - resources
 - configuring for NDMP 529
 - response time
 - managed event 416
 - Restart Window attribute 133
 - restrictions on pathnames 672
 - retention policies 160
 - about 157, 158, 160
 - clones, storage nodes 231
 - defined 158
 - usage 158
 - volumes, relabeling 158
 - retention, completion data 353
 - retention, completion message 353
 - retention, save set 353
 - retrieval
 - annotations, empty 699
 - troubleshooting 698
 - retrieving archives 212
 - retrieving save sets 212, 213
 - RPC (remote procedure call)
 - errors 674
 - rpcinfo program 693
- S**
- save program 87, 167, 168, 503
 - save set
 - All save set 62
 - Save Set Data Retention
 - and NetWorker Backup Statistics Reports 368
 - Save Set Details 369
 - Save Set Name 369
 - save set retention 353
 - save sets
 - archives, retrieving 212, 213
 - backup commands 86
 - backups 485
 - client combination 485
 - client file index, entries 161
 - client priority 487
 - cloning
 - described 219
 - manually 225
 - status 223
 - consolidation
 - files, large 153
 - limitations 154
 - NDMP 526
 - nsrsc command 155
 - pools 155
 - usage 153, 154
 - defining 485
 - indexes, viewing 456
 - information, viewing 456
 - load balancing 485
 - media database, entries 161
 - multiplexing 439
 - policies
 - modification 168
 - reports 168
 - predefined 61
 - recoveries 325, 326, 327
 - client file index 338
 - conflicts 327
 - media database 339
 - NDMP 526
 - online indexes 338
 - relocating 327
 - requirements 326
 - usage 325
 - volumes 327
 - recovery
 - compared to index-based recovery 316
 - REGISTRY, backward compatibility 739
 - staging. See staging
 - status
 - clone 223
 - retention policy 160
 - suspected 228
 - SYSTEM
 - manual backups 65
 - point-in-time recovery
 - command prompt 344
 - recover
 - command prompt 343
 - SYSTEM DB
 - backup levels 152
 - basic components 712
 - databases not included 712
 - recovery prerequisites 346
 - SYSTEM FILES
 - backup levels 152
 - basic components 711

- SYSTEM STATE
 - backup levels 152
 - basic components 710
 - optional components 710
 - recovery prerequisites 346
- VSS ASR DISK
 - backup levels 153
 - components 716
- VSS OTHER
 - backup levels 153
 - components 716
- VSS SYSTEM
 - manual backups 65
 - point-in-time recovery 344
- VSS SYSTEM BOOT
 - backup levels 152
 - components 714
- VSS SYSTEM FILESET
 - backup levels 153
 - components 714
- VSS SYSTEM SERVICES
 - backup levels 153
 - components 715
- VSS USER DATA
 - backup levels 153
 - components 716
- savegroup completion report 448
- Savegroup parallelism 438
- savegrp program
 - backup limitation 676
 - save set consolidation from command line 155
- savepnpc program
 - message logging by 94
 - using with customized backup program 91
- savepsm 79
- savestream 184
- scalability 33
- SCANDISK, running 65
- scanner program
 - NDMP 526
 - record size 670
 - recovering clone volumes 227
 - recovering save sets from volumes 163
 - recreating online indexes 327
 - recreating volume entries 327
 - retention policy 160, 161
 - volumes, read-only 670
- Schedule attribute 133
- Schedule resource 130
- schedules 140
 - attributes 144
 - backup cycle 141
 - balancing 143
 - copying 145
 - default 141, 142
 - deleting 145
 - editing 145, 155
 - large filesystems 143
 - load balancing 485
 - naming restrictions 670
 - overriding 145
 - planning 143
 - preconfigured 141
 - staggered 142
 - usage 140
- Schedules window 144
- scheduling backups 79
- SCSI address selection for HP-UX 749
- SCSI ID 106
- security
 - application authentication 476
 - backup server access 440
 - backup server user groups 442
 - console server users 406
 - lockbox for pass phrases 475
 - login authentication 406
 - overview of settings 777
- server
 - problem contacting 701
 - setting up 433
 - web address 39
- server name
 - attribute of managed event 389
- Server parallelism 437
- servers
 - address, changing 697
 - administrators
 - adding 441
 - backup
 - operators Group 446
 - client/server communication errors 691
 - clients
 - tasking rights 486
 - DCHP 446
 - DNS name resolution 446
 - dynamic addressing 446
 - errors, binding to 694
 - file 487, 689
 - index
 - backup, failure 676
 - management 454
 - notifications
 - priorities 451
 - ping command, testing 693
 - testing 693
- service
 - gstd 50
 - jobsd 50
 - nsrd 49
 - nsrindexd 49
 - nsrmmdbd 49
 - nsrmmgd 49
 - port, HTTP 39
- services
 - Backup and Recover Server 446
 - described 49
 - Power Monitor service 742
- session management 32
- sessions
 - lists of backup, recover, or browse sessions 394

- Setting 354
 - setting
 - data retention policies 354
 - environment variable 419
 - expiration policies 354
 - severity of managed event 389
 - shadow copy 646
 - short filename support 84
 - silos
 - NDMP support 534
 - Simple Network Management Protocol. See SNMP
 - size of
 - gstd log 704
 - log file 419
 - sleep state
 - defined 742
 - SnapImage
 - autochanger handle 570
 - snapshot 646
 - snapshot policy
 - creating 166
 - SNMP (Simple Network Management Protocol) 574
 - configuring 574, 576
 - defined 574
 - notifications
 - configuring 574
 - creating 575
 - modifying 575
 - nsrtrap 574
 - traps 574
 - Software Administration button 37
 - Solaris
 - EMC AutoStart, using with 494, 497
 - troubleshooting 746
 - unsupported devices 746
 - sorting managed event, example 40
 - sorting table 40
 - Source Client dialog box 325, 326, 327, 328
 - sparse files 739
 - not in SYSTEM save sets 712
 - sparse files, converting 677
 - Special Handling dialog box 78
 - stacked bar report format 364
 - stacking bar chart 364
 - staging
 - defined 236
 - filesystem devices 236
 - policies
 - creating 236
 - deleting 239
 - editing 238
 - to cloud 125
 - Start Time attribute 133
 - starting
 - server process 51
 - status
 - viewing
 - group status 394
 - status values, scanned-in 338
 - stopping Console server 51
 - storage nodes
 - affinity
 - problems 699
 - clusters
 - startup script 506
 - virtual storage nodes, support 506
 - timeouts 700
 - troubleshooting 699, 700
 - virtual server 506
 - Store Index Entries attribute, with archive pools 208
 - storing database failed 702
 - support
 - for firewall 718
 - suspected save sets 228
 - symbolic links
 - Tru64 754
 - symptom of problem 701
 - sysconfig command 560
 - System File Protection
 - backup 711
 - defined 711
 - explained 711
 - recover 711
 - SYSTEM FILES save set 711
 - system standby 742
 - SYSVOL
 - SYSTEM STATE save set 710
- ## T
- tables
 - display or hide columns in 41
 - multicolumn sorting 41
 - rearranging columns 40
 - sorting 40
 - Target sessions 439
 - TCP/IP
 - certification 696
 - changing NetWorker server address 697
 - DHCP clients 446
 - host name determination 446
 - troubleshooting hostname alias problems 671
 - technical support, troubleshooting information 662
 - temporary enabler code
 - expired 701, 702
 - temporary notes 390
 - Terminal Services Licensing
 - recover
 - prerequisites 346
 - This 679, 749
 - thread, programming 416
 - three-party NDMP backups
 - introduction 524
 - performing 540
 - time attribute of managed event 389
 - time range 358
 - Together 130
 - toolbars
 - User program 45
 - tracking
 - cloned data 226

- online index information 454
 - traps
 - categories 576
 - SNMP 574
 - troubleshooting 416, 419
 - aborted recover 674
 - AIX
 - STK-9840 754
 - archive pools 699
 - archive requests
 - naming 699
 - archives 698
 - multiple save sets 699
 - nsrchive program 699
 - remote request failure 698
 - auto media verification 669
 - autochangers
 - AIX considerations 754
 - attributes 679
 - autodetected scsi errors 680
 - control port access 682
 - destination component 680
 - HP-UX 752
 - HP-UX considerations 751, 752
 - maintenance 680
 - backups 667
 - backups levels 672
 - backups, stopping 668
 - bootstrap printing, failure 676
 - client file index
 - size growth 673
 - clients
 - alias 671
 - Solaris, location 746
 - connectivity issues 697
 - daemons 667
 - devices
 - maintenance 680
 - nonrewinding 683
 - Solaris, unsupported 746
 - disk label errors 675
 - DNS connection problems 696
 - DNS hostname alias 671
 - ECB counter 669
 - file conversion 677
 - firmware 685
 - hosts table 691, 693
 - HP-UX
 - error messages 751
 - SCSI pass-through driver 752
 - unloading drives 752
 - unsupported media 752
 - illegal characters 670
 - IP configuration issues 696
 - IP errors 691
 - IRIX 756
 - licensing, copy violation 676
 - name resolution 692
 - name server issues 697
 - name servers, disabling 692
 - nsrexec processes 667
 - online indexes 670
 - packet receive buffer 669
 - pathname restrictions 672
 - port range configuration 698
 - portmappers, verifying 693
 - recoveries 667
 - interrupted backups 672
 - new installation 672
 - online indexes 670
 - remote access 689
 - recovering POSIX hard links 85
 - renamed client backups 673
 - retrievals 698, 699
 - routers 685
 - rpcinfo command 693
 - scanner program 670
 - server errors, binding to 694
 - server index 676
 - Solaris 746
 - storage nodes 699, 700
 - technical support information 662
 - Tru64
 - restoring symbolic links 754
 - xview errors 676
 - Tru64
 - symbolic links 754
- ## U
- uasmm program 670
 - unresponsive browser 701
 - URL
 - Console software 39
 - user
 - authentication 417
 - deleted 383
 - deleting 411
 - editing 412
 - properties 412
 - user authentication 417
 - user datagram protocol
 - disabling 417
 - user groups 442
 - creating 444
 - privileges 443
 - user interface
 - overview 36
 - setting preferences 43
 - User List Report 378
 - user privileges 44
 - User Reports 355
 - user roles in Console server 406
- ## V
- vanishing managed event 703
 - variable
 - case sensitivity 419
 - for gstd log 704
 - GST_DEBUG 704

- GST_MAXLOGSIZE 419
- GST_MAXLOGVERS 419, 704
 - setting 419
- verification
 - NetWorker User program
 - browse windows 45
 - of files 69
- Verify button 45
- verifying ASR recovery 595
- versions of the gstd log file 419
- view
 - document view 366
- viewing
 - annotation 391
 - enterprise hierarchy 427
 - reports 360
- VMware 656
- volume pool
 - See also pools
 - archive 204
 - defined 184
- Volume Shadow Copy Service
 - commands 652
 - controlling from Administration window 649
 - controlling from command-prompt 651
 - controlling from NetWorker client 650
 - limitations with Microsoft Exchange Server 318
 - limitations with Microsoft SQL Server 318
 - overview 646
 - writers 648
- volumes
 - archive 229
 - client file index
 - removing 461
 - cloning 227
 - archive data 229
 - creating 227
 - recovery 227
 - labeling 197
 - maximum size 200
 - tips 200
 - modes
 - types 291
 - nonrewinding 683
 - recoveries, required for 324
 - recycling 460
 - relabeling 288
 - removing 460
 - save sets
 - recoveries 327
 - verify 69
- VSS. See Volume Shadow Copy Service
- VTL
 - path-to-tape support 555

W

- waiting priority 390, 398, 401
- warning priority 390, 398, 401
- web
 - browser

- unresponsive 701
- Console
 - server name 39
- Windows disaster recovery
 - 2003, XP 585
 - 2008, 2008 R2, Windows 7 597
- WINS (Windows Internet Naming Service) 446
- WINS (Windows Internet Naming Service) database 83, 348
- Wizard
 - Console Configuration 420
- wizard
 - client backup configuration 55
 - device configuration 247
- writer 648

X

- xview, errors 676

Z

- zone, control 426